

**Jutta Geldermann  
Martin Treitz  
Hannes Schollenberger  
Otto Rentz  
(Eds.)**

# **Challenges for Industrial Production**



Workshop of the PepOn Project: Integrated Process Design  
for Inter-Enterprise Plant Layout Planning of Dynamic Mass  
Flow Networks

Karlsruhe, November 7. & 8., 2005





Jutta Geldermann, Martin Treitz,  
Hannes Schollenberger, Otto Rentz (Eds.)

## **Challenges for Industrial Production**

Workshop of the PepOn Project: Integrated Process Design for Inter-Enterprise  
Plant Layout Planning of Dynamic Mass Flow Networks  
Karlsruhe, November 7. & 8., 2005

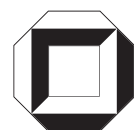


# Challenges for Industrial Production

Workshop of the PepOn Project: Integrated Process Design  
for Inter-Enterprise Plant Layout Planning of Dynamic Mass  
Flow Networks

Karlsruhe, November 7. & 8., 2005

Jutta Geldermann  
Martin Treitz  
Hannes Schollenberger  
Otto Rentz  
(Eds.)



---

universitätsverlag karlsruhe

## **Impressum**

Universitätsverlag Karlsruhe  
c/o Universitätsbibliothek  
Straße am Forum 2  
D-76131 Karlsruhe  
[www.uvka.de](http://www.uvka.de)



Dieses Werk ist unter folgender Creative Commons-Lizenz  
lizenziert: <http://creativecommons.org/licenses/by-nc-nd/2.0/de/>

Universitätsverlag Karlsruhe 2005  
Print on Demand

ISBN 3-937300-85-6

---

## PREFACE

The need of increasing production efficiency, the improvement of environmental performance, the compliance with legal requirements, and, at the same time, the conservation of the social responsibility are only some of the future challenges for industry. Technical improvements, governmental initiatives and changes in industry structures challenge enterprises especially in fast growing economies such as China and Chile. Supply chains are no longer linear arrangements of processes ending at a final consumer; rather there is an increasing shift to recycling, and by-products are used in other supply chains.

Therefore, holistic approaches for process design and operations planning are being developed and applied. The combination of methods of process integration, engineering and Operations Research (OR) considers a variety of economic and environmental process attributes for an integrated technique assessment, allowing to investigate changes within global supply chains. For an integrated assessment of mass and energy flows the specification and detailed mapping of the technical requirements and the material properties is essential. Furthermore, new business concepts are required implementing organizational and technical innovation in inter-enterprise applications.

The French-German Institute for Environmental Research (DFIU/IFARE) of the University of Karlsruhe (TH) investigates such approaches within the research project PepOn "Integrated Process Design for the Inter-Enterprise Plant Layout Planning of Dynamic Mass Flow Networks" together with partners from Chile and China. In that context, the international workshop on "*Challenges for Industrial Production*" (7. – 8. November 2005 in Karlsruhe) presents a selection of approaches and examples from practice addressing economic, environmental and technical goals for process optimisation. The different sections of the workshop and its proceedings at hand focus on research and industry applications in the following fields:

- Process Optimisation in Industry
- Strategies in Global Markets
- New Methods for Dynamic Planning
- Application of Pinch Analysis
- Case studies from Industrialising Countries
- Life-Cycle-based Improvement Approaches
- Product-based Improvement Approaches

We as organizers of the workshop and editors of these proceedings are grateful for the good attendance, which is reflected by the internationality and interdisciplinarity of the workshop's participants and the scope of the contributed papers. We are glad to offer a documentation, which may foster the exchange of scientific approaches and their practical application.

We would like to thank all authors of the book and participants of the workshop. Our special thanks go to our project partners:

- Marcela Zacarías M., Jens Neugebauer and Dr. Alex Berg G.  
(Unidad de Desarrollo Tecnológico (UDT), Universidad de Concepción,  
Concepción, Chile)

- 
- Surong Guo and Prof. Yongsen Lu  
(College of Environmental Science and Engineering (CESE), Tongji University, Shanghai, P.R. China)
  - Dr. Yinan Wang and Prof. Fengqi Zhou  
(Energy Research Institute (ERI), State Development and Reform Commission, Beijing, P.R. China)

It is a pleasant duty for us to express our sincerely gratitude towards the VolkswagenStiftung and especially Prof. Hagen Hof. Without that grant of the VolkswagenStiftung within their program for the funding of researchers in the interdisciplinary field of environmental research, such an unusual and perhaps visionary project would not have been possible.

Jutta Geldermann, Martin Treitz, Hannes Schollenberger, Otto Rentz

French-German Institute for Environmental Research (DFIU/IFARE)  
University of Karlsruhe (TH), Germany



---

## TABLE OF CONTENTS

### Challenges for Industrial Production

- The Forestry Industry in Chile: Big opportunities and Mayor Challenges for Research, Industry and the Public Sector** 1

Alex Berg

Unidad de Desarrollo Tecnológico, Chile

- The Challenges of Building Eco-industrial Parks through Inter-Enterprise Planning of Dynamic Mass flow Networks in China** 9

Cunkuan Bao, Yongsen Lu, Shaoping Wang, Surong Guo

Tongji University, China

- Optimisation Beyond Best Available Techniques** 21

Jutta Geldermann

University of Karlsruhe, Germany

### Process Optimization in Industry

- ECO Engineering – An Engineered Methodology for Sustainable Process Improvement in Chemical and Pharmaceutical Industry** 31

Nicolaus Thissen

Ciba Specialty Chemicals Schweizerhalle Inc., Switzerland

- Process Optimisation in the Wood Coating Sector** 41

Flaviano D'Amico, Maria Velardi, Giulio D'Amico

ENEA, Italy

### Strategies in Global Markets

- Modelling and Simulation in the Sector of Natural Stones for Improving the International Competition** 49

Stefano Saetta

University of Perugia, Italy

- The Impacts of Globalisation on East Asian Technological Development: Lessons for other Developing Countries like Iran** 55

Reza Salami

University of Allameh, Iran

- Cleaner Production Techniques in the Peruvian Mining Sector** 61

Samuel Mongrut, Sonia Valdivia

Pontificia Universidad Católica del Perú, Perú

---

## **New Methods for Dynamic Planning**

**Adjusting Financial Risk Measures to Industrial Risk Management** 69  
Clemens Werkmeister  
University of Hohenheim, Germany

**Supply Chain Integration: Improvements of Global Lead Times with SCEM** 79  
Julia Pahl, Stefan Voß, Andreas Mies  
University of Hamburg, Germany

**Management, Forecasting and Optimisation of Environmental Data within Emission Trading Markets** 89  
Stefan Pickl  
Universität der Bundeswehr München (University of the German Armed Forces), Germany

## **Application of Pinch Analysis**

**Integration of small and medium enterprises for better resources management considering the environment** 95  
Toshko Zhelev, Bernadette O'Regan, Richard Moles  
Center for Environmental Studies, University of Limerick, Ireland

**Analysis of Energy Flows by Using Pinch Analysis** 105  
Peter Radgen  
Fraunhofer ISI, Germany

**Multi Objective Pinch Analysis: OR in Engineering** 117  
Hannes Schollenberger, Martin Treitz  
University of Karlsruhe, Germany

**The Optimisation of the Process Water Use in Industry by Water Pinch Analysis** 127  
Etienne Brauns, Inge Genné, Wim Schiettecatte, Joost Helsen  
VITO, Environmental and Process Technology, Belgium

## **Case studies from Emerging Countries**

**Case Study on Clean Production in Beijing Automobile Works Co. Ltd** 137  
Yinan Wang  
Energy Research Institute (ERI), China

**Study on the Eco-Industrial Model for Alcohol Distillery** 145  
Guo Surong, Lu Yongsen, Jiang Dahe, Bao Cunkuan  
Tongji University, China

---

## **Life-Cycle-based Improvement Approaches**

**Assessment of a Chemical Production Concept in Process Design** **153**  
Krisztina Cziner, Markku Hurme  
Helsinki University of Technology, Finland

**Dynamic Material Flow Analysis as part of a Life Cycle Assessment  
Tool Chain** **165**  
Andreas Möller  
University of Lueneburg, Germany

**From Hundreds of Suns To Ten Thousand Suns** **175**  
Yingtian Chen, Yinan Wang  
University of Science and Technology, China

### **Posters**

**Decolouration and Degradation of Dye Wastewater by White Rot  
Fungi** **183**  
Cheng Yongqian, Lu Yongsen, Jiang Dehe  
Tongji University, China

**Adsorption of Cu(II) and Cd(II) Removal from Water by Weak Base  
Epoxy Anion-exchange Resin** **191**  
Ma Hong-mei, Zhu Zhi-liang, Zhao Jian-fu  
Tongji University, China

**Simulation of Policy Incentives to promote Cleaner Production in an  
Alcohol Distillery** **199**  
Zheng Wei, Bao Cunkuan, Guo Surong , Lu Yongsen  
Tongji University, China



# **THE FORESTRY INDUSTRY IN CHILE: ENORMOUS OPPORTUNITIES AND MAJOR CHALLENGES FOR RESEARCH, INDUSTRY AND THE PUBLIC SECTOR**

**Alex Berg**

Unidad de Desarrollo Tecnológico, Universidad de Concepción, Chile

The Chilean forestry sector has experienced enormous changes during the last 30 years. In the mid 70s, the Chilean state decided to subsidize re-forestation with pinus and eucalyptus species, resulting in the actual plantation of 2.4 million hectares that annually produce 27 million m<sup>3</sup> of wood. At the same time, a modern forestry industry was established, based in the production of pulp (2.9 million ton/year), wood-based panels (1,4 million m<sup>3</sup>/year) and lumber (7 million m<sup>3</sup>/year). This pioneering development has made it possible for Chilean companies to successfully expand their business to other countries in South, Central and North America.

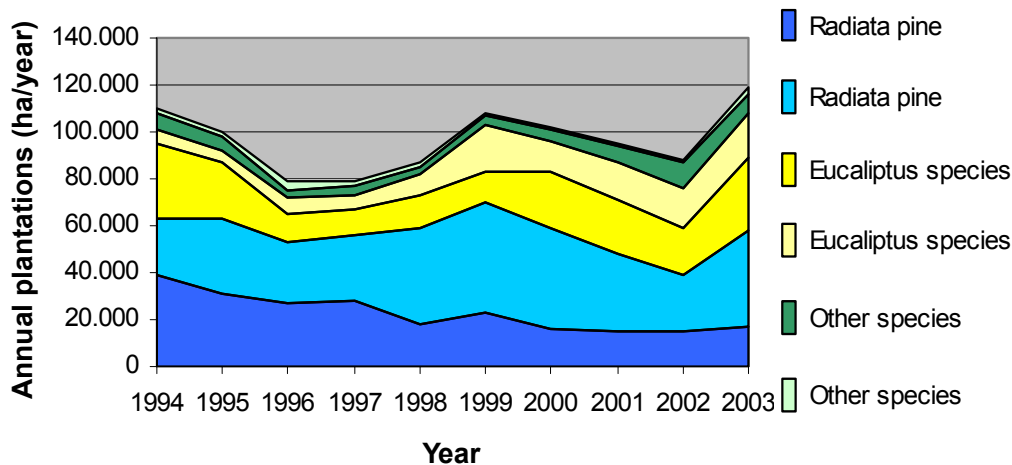
Nevertheless, the strong position of the Chilean forest industry in Chile and abroad is accompanied by enormous future challenges. One challenge is presented by the demand by the Chilean population for stronger environmental protection measures, complicating the development of new industrial complexes, such as the integrated saw mill, pulp mill, plywood and energy plant begun in Nueva Aldea with a total annual wood consumption of over 5 million m<sup>3</sup>/year. Another challenge is the need to gradually change the massive production of commodities with little added value to the production of goods with higher added value and to a better utilization of byproducts from the forestry and the forest processing industry. This goal, however, can only be achieved if a real effort is made by the public and private sectors to push the Chilean technological development forward. Some of the valuable efforts, related to the improvement of some properties of wood, the development of new composite materials, and the use of residual biomass as an energy source, which have been done by the Unidad de Desarrollo Tecnológico from the University of Concepción, will be presented.

## **THE FOREST INDUSTRY AND ITS DEVELOPMENT**

In the mid 70ies, the Chilean government implemented a policy to encourage plantations of pinus radiata species. The principal reasons for this decision were the following:

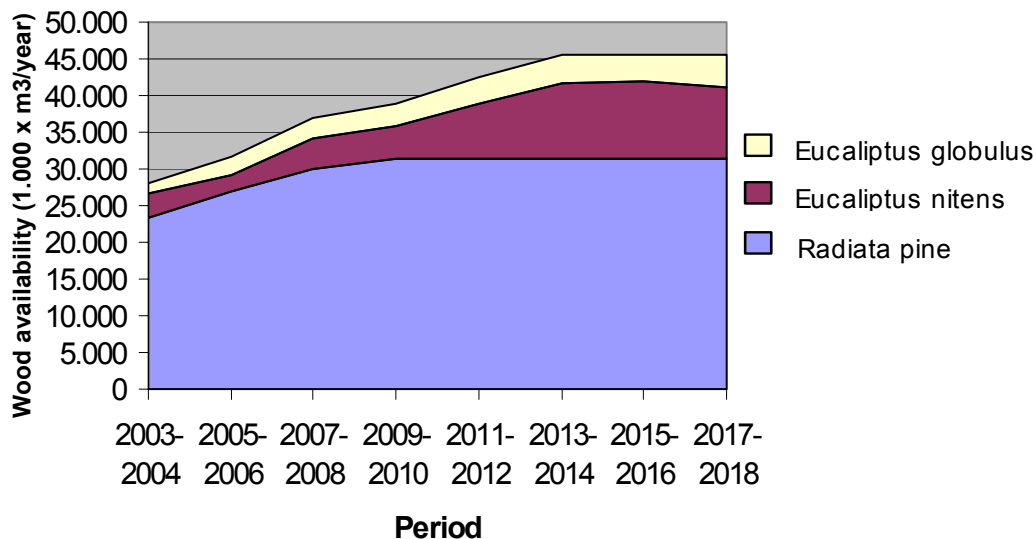
- Economic: A small wood processing industry was being established during the sixties, which comprised two Kraft mills, a sulfite mill, and some wood panel factories. The quality of the native wood supply was not homogenous enough to allow a bigger expansion of the sector
- Ecologic: A main ecological problem in central and south Chile was (and still is) the degradation of the soil by erosion, caused by extensive agricultural use without adequate cultivation technology and crop rotation. The forestation with foreign species was a very good solution for stopping soil erosion by water and wind.

The subvention consisted basically in the payment of a bonus, covering 90 % of the costs to establish a wood plantation, in degraded soils . The final result of this measure was very impressive when considering the number of trees planted (Figure 1).



**FIGURE 1: Plantations of *Pinus radiata* and *Eucalyptus* species in Chile (darker colour: forestation; pale colour: reforestation) (based on data from INFOR, 2005a)**

It is important to consider that the growth presented by *pinus radiata* in Chile is on average  $25 \text{ m}^3/\text{ha}/\text{year}$  and of *eucalyptus globulus* more than  $30 \text{ m}^3/\text{ha}/\text{year}$ . In comparison, in Germany the growth of Spruce, *Pinus sylvestries* and *Fagus sylvatica* is in the range of  $3$  to  $7 \text{ m}^3/\text{ha}/\text{year}$ . This rapid growth makes it possible to harvest an impressive amount of wood in the present as well as in the future. Figure 3 presents the corresponding projections.



**FIGURE 2: Wood availability in Chilean plantations (based on data from INFOR, 2005b).**

### THE WOOD-PROCESSING INDUSTRY

Hand in hand with forest sector development, the forest industry has aggressively expanded its activities in the last decades. In the sixties, the average annual exports from the forest sector were only US\$ 18 million, which grew up to US\$ 2,558 million in the period 2000 – 2004 (Table 1)!

**TABLE 1: Exports of the Chilean forest sector in relation to Chilean total exports (data from: Berg and Grosse, 2004 and INFOR, 2005a)**

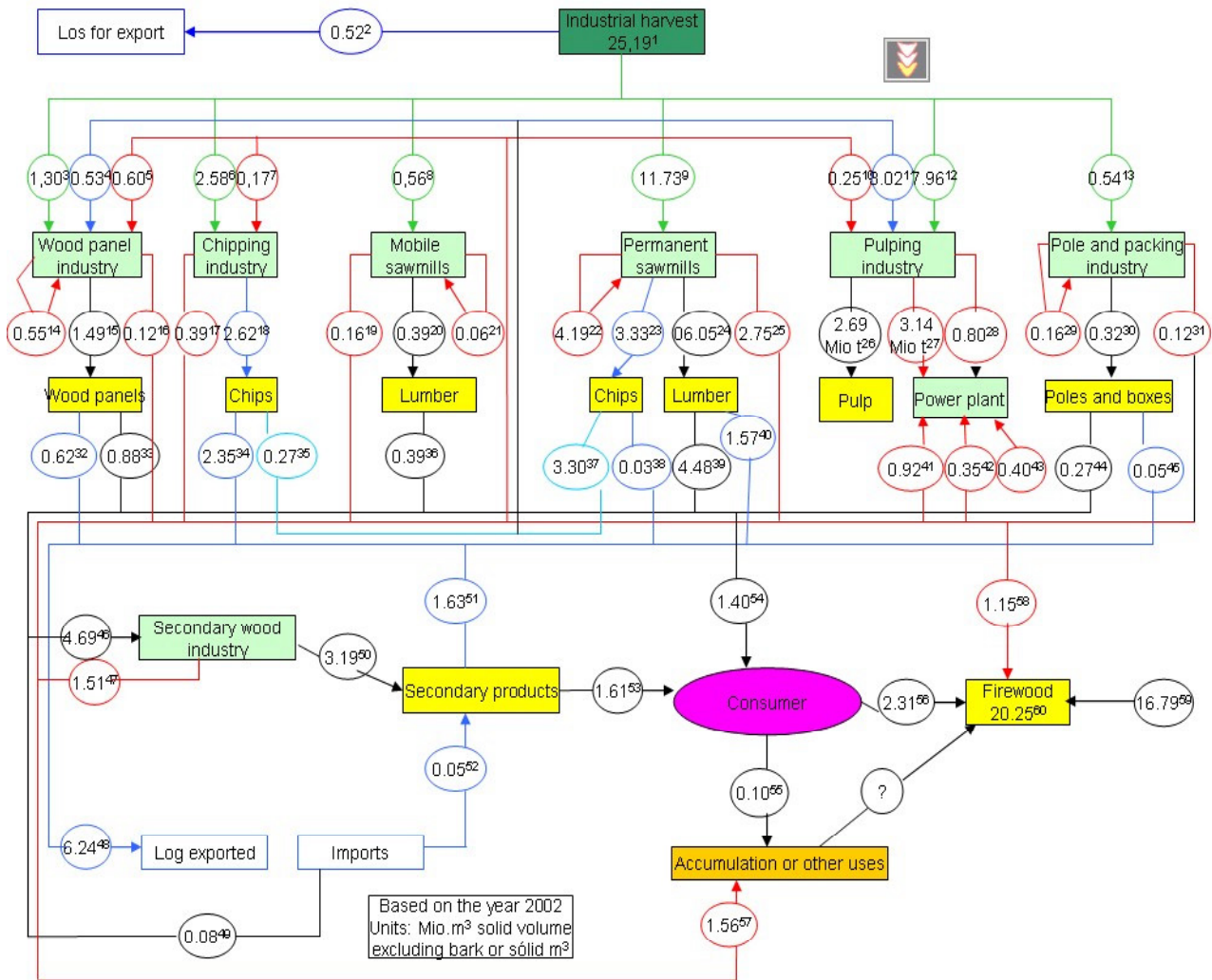
Period	Total annual exports (MM US\$)	Forest annual exports (MM US\$)	Total annual exports / forest annual exports (%)
1960 – 69	704	18	2.6
1970 – 79	1,844	144	7.8
1980 – 89	4,817	478	9.9
1990 – 99	13,282	1,142	11.6
2000 - 04	21,854	2,558	11.7

Actually, the wood processing industry in Chile presented the following production in 2004:

- *Pulp production: 2.9 million ton/year*
- *Lumber production: 7 million m<sup>3</sup>/year*
- *Wood-based panel production: 1.4 million m<sup>3</sup>/year*

As can be seen, there is a strong forestry industry that produces raw materials to supply different industries, principally lumber producers, pulp mills and wood-based-panel plants. The energy and steam production by cogeneration processes based on forest biomass is also becoming an important business due to an increased production, the increasing cost of electricity generated by fossil fuels, and the shortage of natural gas supplied from Argentina. The installed capacity is 180 MW, which represent nearly 1.9% of Chile's total electricity production (CNE, 2005).

Figure 2 presents a diagram of the material flows characterizing the forest and wood-processing industry in Chile (the data is based on the reality of the year 2002). This diagram - the first of its kind developed in Chile – demonstrates the interdependence existing in this sector and how the byproduct of one industry represents the raw material of another.



### Legend:

1=Total log production; 2=Log exports; 3=Log consumed by the wood panel industry; 4=Chip consumed by the wood panel industry (only dry chips); 5=Byproducts consumed by the wood panel industry (dry chips are included); 6=Logs consumed by the wood chip industry; 7=Byproducts consumed by the wood chip industry; 8=Logs consumed by mobile sawmills; 9=Logs consumed by permanent sawmills (logs for chip production are included); 10=Byproducts consumed by the pulping industry; 11=Chips consumed by the pulping industry; 12=Logs consumed by the pulping industry; 13=Logs consumed by the pole and packing industry; 14=Internal byproducts consumption by the wood panel industry; 15=Wood panel production; 16=Byproducts generated by the wood panel industry; 17=Byproducts generated by the chip industry; 18=Chip production by the chip industry; 19=Byproducts generated by mobile sawmills; 20=Lumber produced by mobile sawmills; 21=Internal byproduct consumption by mobile sawmills; 22=Internal byproduct consumption by permanent sawmills (chip are included); 23=Chip production in permanent sawmills; 24=Lumber production in permanent sawmills; 25=Byproducts generated in permanent sawmills (production is included); 26=Pulp production (million tons); 27=Bleach liquor generation (million tons); 28=Byproducts generated for combustion (bark); 29=Internal byproducts consumption by pole and packing industry; 30=Pole and packing production; 31=Byproducts generated by pole and packing industry; 32=Wood panel production for exports; 33=Wood panel production for the internal market; 34=Chips for exports (only chip industry); 35=Chips for inland consumption (only chip industry); 36=Lumber production in mobile saw mills; 37=Chips for the internal market (only sawmills); 38=Chips exports (only sawmills); 39=Lumber for inland consumption (only permanent sawmills) (production - exports); 40=Lumber exports; 41=Byproducts consumed for energy generation in the pulping industry; 42=Byproducts consumed in Nacimiento and Mostazal power plants; 43=Byproducts consumed in Laja and Constitution power plants; 44=Poles and packing production for the internal market; 45=Poles and packing production for exports; 46=Wood consumed by secondary wood industry 47=Byproducts generated secondary wood industry; 48=Wood product exports (logs are not included); 49=Wood products imports; 50=Secondary wood industry production; 51=Secondary wood industry exports (incl. sawmill production); 52=Processed lumber imports; 53=Processed lumber for the internal market; 54=National consumption of processed lumber; 55=Post consumer woody materials for deposition; 56=Post consumer woody materials for combustion; 57= Byproducts accumulation; 58= Wood consumption for non-industrial combustion; 59= Non-industrial wood for firewood; 60=Firewood consumption

**FIGURE 3: Flowchart of wood and wood by-products of the Chilean forestry and wood processing industry (Wahlberg et al., 2005)**



In fact, the established saw mills are the largest producer of by-products, nearly 10 million m<sup>3</sup>: 3.33 million solid m<sup>3</sup> of wood scraps are internally converted to wood chips (which is the raw material for pulp and MDF panel producers); 4.19 solid m<sup>3</sup> are used internally for energy production and 2.75 million solid m<sup>3</sup> (principally sawdust) are offered to the market. This sawdust is used by particleboard producers, cogeneration power plants and – in a much smaller proportion - by other consumers.

Until the beginning of 2004, the sawdust was practically free of charge, being only necessary to pay the transport cost from the producer to the consumer. Indeed, it is estimated that nearly 20 million m<sup>3</sup> of sawdust were accumulated in Chile during the last 20 years (Wahlberg et al., 2005). But the situation has changed. Now the surplus production of wood by-products (which was 1.52 million m<sup>3</sup> in the year 2002 (figure 3)) has diminished drastically, and consequently this material has become more valuable and now has a positive, increasing price. Depending on the region, prices as high as 25 US\$/dry ton are paid.

Indeed, the growth of the wood processing industry continues. The pulp production capacity will grow in 1.5 million tons/year in the 2005 – 2008 period, and panel production will increase in nearly 800 million m<sup>3</sup> during the same period.

## **THE CHALLENGES AND THE ROLE OF THE R&D**

The Chilean forest and wood processing industry is reaching a point where the growth of the sector will be limited, if the focus is set only on obtaining higher production volumes and better utilization of the available raw materials. The present challenge is to add value to the products and two concerted actions are of key importance:

### **Improving the competitiveness of small and medium-size enterprises**

Presently, the Chilean forestry and wood processing industry is dominated by two big players: the Arauco and CMPC groups, which have expanded their business to several other Latin American countries and are among the 10 largest companies of this sector in the world. An important role is also played by the Masisa Company, which is the leader in Latin America with respect to wood-based panel production, with production plants in Chile, Argentina, Brazil, Venezuela and Mexico. These companies are characterized by a vertical integration of their production processes, very high production volumes, and the use of good technology but also by the production of products with low differentiation in the international markets and, consequently, relatively low prices. Until now, there are very few technology-based businesses related to the forestry sector, and the technology is principally bought abroad and the adding value chain is short and brittle. There is a need to expand and strengthen small and medium size enterprises in order to create more employments, to develop high value products for niche markets, and to establish a better network of specialized services and supplies.

### **Improving R&D capability**

The public sector is making a big effort to increase the public R&D spending from nearly 0,5 % of GNP to 1 % during the next 5 years. But the industry also needs to participate in this effort: At present, they only contribute with 17 % in the national R&D spending (compared with the 83 % of the public sector). Together with this financial effort, the scientific and technological capacities, equipment, and a trained professional and technical staff is a very important issue.

The University of Concepción has begun several interesting development to better use the available wood raw materials, to develop new products for the local and international markets, and to promote a better integration between the forest and wood-

processing industry, the public sector, and research and development centers as well as the integration of an informed population. Some examples are the following:

*A) Development of a new material based on wood “petrification”*

Dr. Burhard Seeger, Professor of Inorganic Chemistry at the University of Concepción, had the idea to improve on some of wood’s disadvantages, such as its vulnerability to attack by microorganisms, insects and fire by making a silicate-based composite material. After a proper impregnation procedure, a very thin layer of silica is deposited in the interior of wood cavities, which acts as a cementing protection for the wood, making it possible to retain and insolubilize other chemicals like boron. The density of the new material increases in 10 %, and the price is nearly 50 US\$/m<sup>3</sup> compared with the wood without treatment. Its main applications will be the house construction market, but also other uses like piles for vineyards, children playgrounds, and fences. The process was developed and patented in the University of Concepción (Seeger, 2002), and at the beginnings of 2005, the technology was licensed to a new company called Stone Wood S.A.

*B) Development of wood-plastic composites and the introduction of its products into the market*

Another new material, with a high proportion of wood, is a wood-plastic-composite (WPC) that is made by dispersing small wood granules in a traditional thermoplastic material (like polyethylene or polypropylene) or biodegradable plastics derived from biomass (like polylactic acid, polyhydroxybutirates or cellulose acetates). These materials were developed industrially in the USA nearly 15 years ago, where they have a market of US\$ 1,000 million in 2004. In Chile, the University of Concepción together with the German institute Fraunhofer Umsicht developed the technology with local raw materials, and now is opening a market for WPCs by identifying customers who would like to produce final products by injection molding and extrusion.

Two main applications are the following: Parts for fishing docks to replace the traditionally used wood lumber, which is attacked by a shipworm called *Teredos navalis*, and the production of biodegradable recipients for tree plants to avoid a transplantation procedure and its associated stress, which presents the loss of nearly 2 – 4% of the plants. Both applications will be introduced into the market during 2006.

*C) First steps into the establishment of “bio-refineries” in Chile*

Wood has gained new importance as a raw material due to the increased price of oil and the acceptance that fossil fuel availability will increasingly decline in the next few decades. In addition to its known uses for lumber, pulp and wood-based panels, wood is also a source to obtain advanced materials, chemical products, and solid, liquid and gaseous fuels. The term “biorefineries” is used to define this new approach. The technical possibilities are quite numerous, but if the economical aspect is considered, only few possibilities have a real chance to be carried out in the short term. In Chile, the University of Concepción is making a big effort to establish a long-term program together with the pulping industry, the chemical producers and the energy concerns to create the technological, economical and environmental basis to transform this vision into reality, considering short-, medium- and long-term approaches.

**REFERENCES**

- Berg, A. and H. Grosse. 2004. Combustión de biomasa. Taller de Energías Renovables, Situación Mundial y Usos Potenciales en el País, University of Concepción, Chile, January 11 – 13, 2005.
- CNE, 2005: [http://www.cne.cl/mapa/f\\_electrico.html](http://www.cne.cl/mapa/f_electrico.html).
- INFOR, 2005a. <http://www.infor.cl>.
- INFOR, 2005b. Disponibilidad de madera de plantaciones de pino radiata en Chile, Informe Técnico 170, Instituto de Investigación Forestal, Concepción, Chile.
- Seeger, B. 2002. Proceso de petrificación acelerado de materiales lignocelulósicos. Chilean Patent Application Number 2000-746-2002, November 19, 2002.
- Wahlberg, F.; Radon, F.; Neugebauer, J. and A. Berg. 2005. Disponibilidad de madera residual en Chile. Published by UDT and GTZ, in revision.



# **THE CHALLENGES OF BUILDING ECO-INDUSTRIAL PARKS THROUGH INTER- ENTERPRISE PLANNING OF DYNAMIC MASS FLOW NETWORKS IN CHINA**

**Cunkuan Bao, Yongsen Lu, Shaoping Wang, Surong Guo**

Institute of Environmental Management

College of Environmental Science and Engineering, Tongji University, Shanghai, China

**Industrial parks (IPs) have been aroused to make rational adjustment in the distribution of small and medium enterprises (SMEs) in towns or cities in China since 1980s. Over the years two kinds of IPs have been developed in the country. The first is the parks with one or several anchor companies. The second is the parks composed of SMEs from many distinct business sectors but without anchor enterprises, which account for the main part of the total IPs. The challenges of guiding the second IPs onto eco-industrial parks (EIPs) might be that a series of barrier had to be surmounted. This paper described five principles in EIP planning to contend the challenge through three case studies. The essential prerequisite to make the principles effective in EIP development would be re-adjustment and/or reinforcement of government policies, i.e. the strengthening pollution monitoring and strict enforcement of laws and environmental standards; increasing the rates of pollution charges and resource taxes; adopting deposit-refund system in solid waste management; and promoting environmental information open to public.**

## **INTRODUCTION**

Over the years China government has actively been pursuing circular economy (CE) and simultaneously issuing a series of policies to encourage local governments and industrial communities to practice CE. In fact, the theoretical basis of “Circular economy” is “Industrial ecology” and “Concepts of sustainable development”, which was derived from developed country’s mode with Chinese characteristics. There are three levels to build CE planning in China, that are circular society, the highest; EIPs, the medium level; and cleaner production and product’s eco-design, the base level. Industrial parks (IPs) have been aroused to make rational adjustment in the layout or distribution of small and medium enterprises (SMEs) in towns or cities in China since 1980s. Over the years a great number of IPs have been developed, and in the meantime many big companies have been settled down.

Pursuing CE the government has encouraged IPs with better conditions to transform to or build demonstrative eco-industrial parks (EIPs).

EIP is a vital collection pattern of enterprises with different business purposes. Based on the integrated utilization of mass, energy and water, and the principles of industrial symbiosis, theoretically there will be a holistic industrial supply-demand network for by-products, wastes and residues exchange. General speaking there are two kinds of IPs. The first kind of industrial parks are distinctive with anchor companies, e.g. the Asnaes power station in Kalundborg, Denmark and the sugar refinery in Guitang Group, China. For this kind of parks it is relatively practicable relying on anchor companies to promote building industrial chains and forming EIPs. Another kind is the industrial parks without anchor companies, composed of SMEs from distinct business sectors. The driving force for SMEs getting together usually is the park’s advantages of geographical location, better infrastructure conditions, and good relations to local communities as well. In China most IPs can be included into the second kind. Building or reforming the second kind of IPs into EIPs is really a challenge and quite a task.

The paper gives a brief introduction of the official guidelines on planning demonstrative EIP at first, then describes the conception of planning, practical situation and barriers to organize inter-enterprise mass, energy and water flow networks through three case studies. The final part of the paper discusses the essential prerequisite to make the planning conception effective, that are the government policies, i.e. strict enforcement of law and environmental standards, increasing pollution charges and resource taxes and promoting environmental information open to public.

### **PRACTICAL ISSUE OF THE “GUIDELINES FOR PLANNING DEMONSTRATIVE ECO-INDUSTRIAL PARK”**

To build circular economy China SEPA (State Environmental Protection Agency) has formulated and issued serial policies and guidelines, among which the “Guidelines for Planning Demonstrative Circular Economy Zone” (trial implementation) (Huan Fa [2003] No.203) and “Guidelines for Planning Demonstrative Eco-Industrial Park” (trial implementation) (Huan Fa [2003] No.208) are closely related to the EIP planning.

According to the guidelines the planning document generally consists of following basic requirements:

- *Introduction to local social, economic and environmental background;*
  - 1) Community, city and regional situation;
  - 2) Situation of the industrial park (IP), e.g. category and structure of enterprises and business, main resources, etc.;
  - 3) The challenges to build the IP into EIP, including the analysis of Park’s advantages, weakness, opportunities and barriers;
- *Objectives and principles of planning;*
  - 1) Overall goal, main objectives and development strategy;
  - 2) Specific targets for different sectors or fields;
  - 3) Principles of planning;
- *Parks master design;*
  - 1) Spatial layout and functional zoning of the EIP; and
  - 2) Master frame of building the EIP; and
  - 3) Business development planning of the park;
- *Park’s symbiosis and co-metabolism;*
  - 1) Main material flows and metabolism analysis;
  - 2) Energy and water flow analysis; and
  - 3) Alternative of re-organization or integration of mass, energy and water flows to form the mechanism of symbiosis and co-metabolism in the park;
- *Construction projects or measures of the Park;*
  - 1) The inventory and directions of construction projects and measures for industrial projects, infrastructure, services and institutions; and
  - 2) Directives on construction projects or measures;
- *Cost-benefits analysis of investment in building EIP;*
  - 1) Total investment and specific project investments;
  - 2) Channels of collecting and circulating the funds; and
  - 3) Economic, social and environmental benefits;
- *Institutions and guarantee*
  - 1) Leading group management committee or coordinate office and investment companies;
  - 2) Park’s management system (If it is a reformation of existing park, special attention should be paid to integrate current management system into future system);

- 3) Policies to encourage economized and integrated mass, energy and water flows, i.e. through land use policy, taxes, subsidy and credit policies, and pollution charge fee and reimbursement, etc.; and
- 4) Supporting system including training and education, information exchange, business incubator, environmental management system and cleaner production audit, etc.

## CASE STUDIES

Three cases have been studied to demonstrate the challenges of building eco-industrial parks. Each case represented specific conception of planning, practical situation and barriers to organize inter-enterprise mass, energy and water flow networks.

### Guitang Group eco-industrial park (GGEIP)

This case displays a typical EIP of first kind.

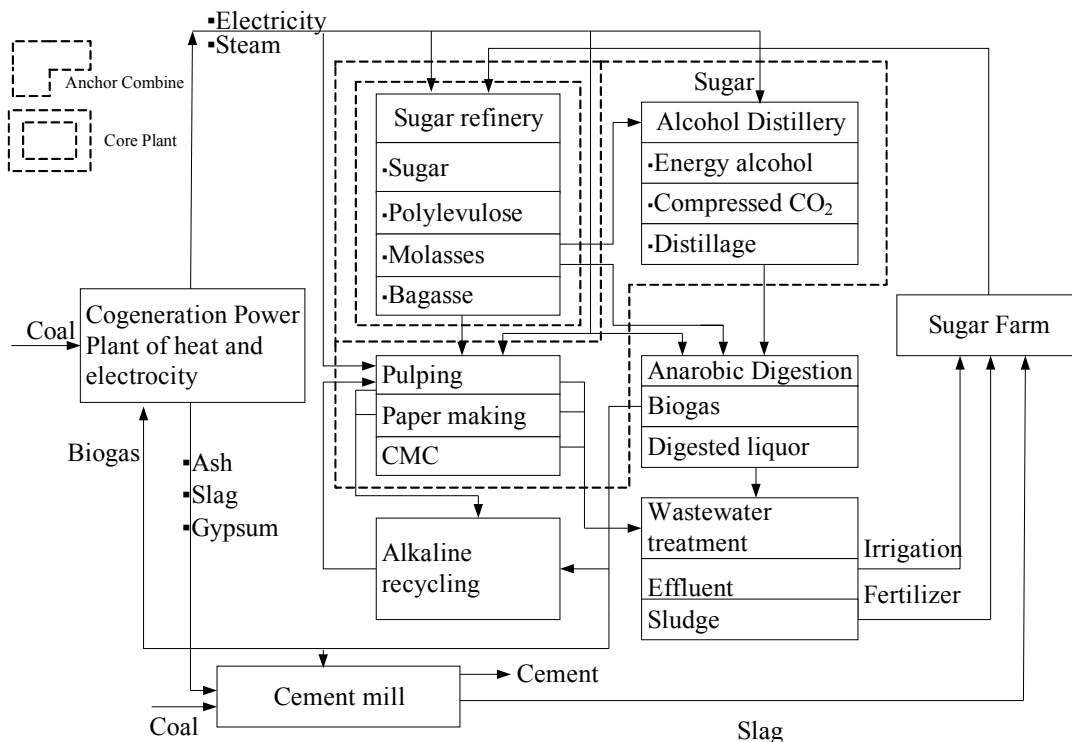
- *Background and motivation of building GGEIP*

The Guitang Group Corporation Co. Ltd. is located at the Guigang city, Guangxi Province, China, originally it was combined of five sugar refineries. There were also some pulp and paper mills, alcohol distilleries and sugar farms in the city, but these enterprises were run by other corporations under different bureaus of municipal or provincial government. Over the years these industrial sectors had been the greatest pollution sources of the city and directly threatened not only the survival of the industries but also local people's health.

To combat the increasingly acute threat the municipal and provincial government have actively promoted the symbiosis of industrial processes and construction of EIP since late 1990s.

- *The feature of the EIP*

This is a typical EIP which has been strongly controlled by local government and with obvious mutual related anchor enterprises or sectors as shown in Figure 1.



**FIGURE 1: The Industrial Symbiosis In Guitang Group Eco-Chains, China (2002)**

(1) *The salient features of the park can be described as follows.*

- *Coupling chains of processes*

The three main eco-chains were: sugarcane farm—sugar refinery—bagasse pulping and paper; sugar molasses for alcohol—distillage for biogas and fertilizer; and sugar, polylevulose, glucoside—low polylevulose, that formed material flow network to fully utilize raw materials and byproducts and produce least wastes.

- *Closed loop of materials*

The sugarcane farm was the source and sink of eco-chains to form a closed loop.

- *Integration of byproducts*

The condensate from sugar refinery and white water from paper mill were re-used in original processes. Sugarcane pith was burnt as a part of boiler fuel. Acid gas from cogeneration power plant was applied to neutralize alkaline pulp wash water through scrubber process. Solid wastes as filter sludge, white slurry and slag were used in cement process and sugar farmland. Through byproduct integration, pollution prevention and/or waste minimization were realized.

- *Flexible structure*

The eco-chains and material-energy integration network of this park might make the products, outputs, resource supply, market demands and stochastically fluctuation of surroundings of Guitang Group more elastic, flexible and with greater ability to resist market risks.

(2) *Benefits of EIP building*

According to incomplete statistics some benefits were shown as follows.

- *Economic benefits*

Based on the 2002 data total investment on fixed assets of EIP construction and technological innovation could be repaid by 2006.

- *Environmental benefits*

Water pollution load in terms of COD<sub>Cr</sub> would be cut down for 50%, equivalent to 30 thousand tons of COD<sub>Cr</sub> eliminated 600 thousand Cubic meters of wood would be saved.

- *Social benefits*

People's health, water quality, etc. are improved.

▪ *The organization of inter-enterprise mass, energy and water flow networks*

There were a number of opportunities to further organize inter-enterprise mass and energy flow networks. Because of lack of policy incentives detail measures e.g. taking advantages of pinch analysis to increase mass and energy efficiency were not in consideration. The reasons are discussed in the Section 4.

### **Eco-design for Ludu Bicycle Park (EDLBP)**

Eco-design for Ludu Bicycle Park is one of the demonstrative projects of the Taicang Eco-city Development Plan.

The initial conception of the Eco-design for Ludu industrial park would be the promotion of symbiosis in a specialized park of bicycle industry through inter-company cooperation to close the mass, energy and water loops. Because of limited data available, high costs in data measurements and collection, and some administrative and legislative issues in developing phase, some contents in EDLBP tended to conceptual planning.

▪ *General Situation*

Ludu is a town in the south of Taicang city, and will be the sub-centre of the city in the near future. The town covers an area of 25.0km<sup>2</sup> with the native population of



12.5 thousands and 17.5 thousands of transient population in 2003. The GDP of the town was 1.04 billion RMB 2003. The pillar industry of the town is bicycle manufacturers. Two million pieces of bicycle were exported from the town.

The first bicycle company of Taiwan investment, Fuerkang corporation was founded in 1993. Over the twelve years more than sixty bicycle companies have got together along the both sides of nine kilometres of “Bicycle Road” and Ludu has won the name of “Bicycle Park” of Taicang, including four integrated assemblage factories, and fifty six factories for part and component production.

A bicycle industry chains including overall assemblage, special component and part producers and regional purchase and sale centres are collected in the park, but the chain did not completely form a supply-demand relations between anchor and satellite enterprises within the park. Now Ludu is one of well-known bicycle export centres in the country.

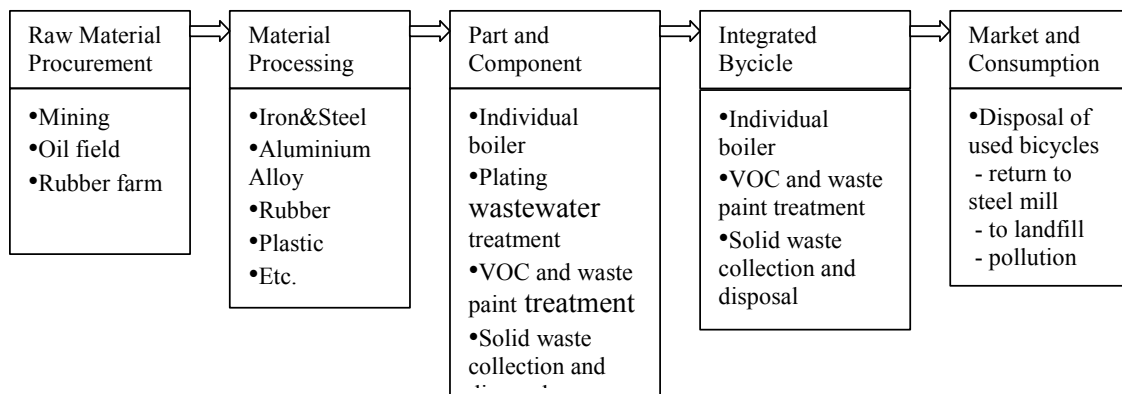
▪ *Eco-Design of the park*

To meet local government’s expectation the main objective of eco-design should be beneficial to Ludu’s reputation as a modern EIP to attract more famous tenants and investments. On the other hand the tenants would pay more attention to the advantages of local favourable geographic conditions, transport facilities, better infrastructure and existent supply-demand chains of bicycle production and extensive cooperation between different enterprises. Based on the foregoing condition the main work of the planning was described as follows.

(1) Change over from linear to circular mode of bicycle production

a) Linear mode of bicycle production

Traditionally bicycle production is a linear mode from raw material mining and processing, part and component production, assemblage, marketing and consumption, and steel recovery from a part of waste bicycle, as shown in Fig.2. In this mode each company has individual boiler station and industrial wastewater treatment system.



**FIGURE 2: Linear mode of bicycle production**

b) Circular mode of bicycle production

The eco-design of bicycle chain in circular mode is shown in Fig.3. The box enclosed in dash lines was the planned bicycle chains in Ludu or neighbor area. To form rather complete chains that the boxes A and B enclosed in dash lines were suggested to be connected together.

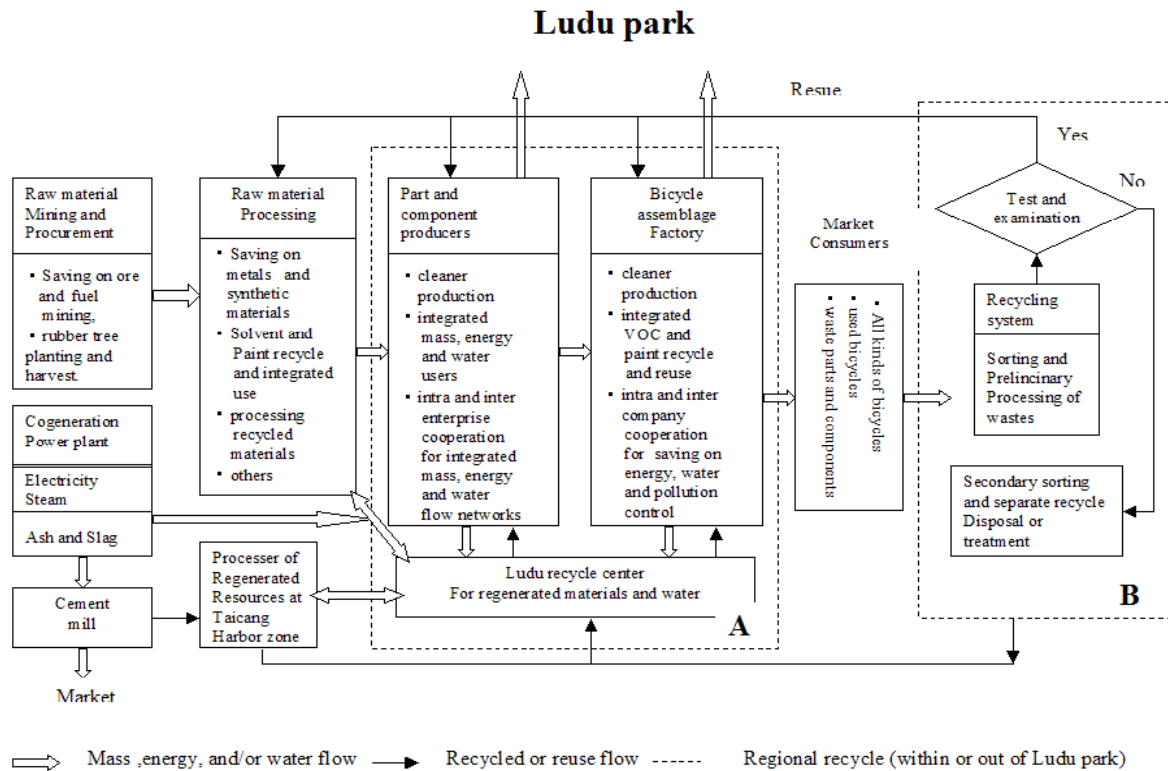
c) Integrated design for inter-enterprise mass, energy and water flow network

Based on the design principles of extended mass and energy network for bicycle industry park (Figure 3) and governmental officials' suggestion the measures accepted in the planning or design are summarized as follows.

A cogeneration power plant of electricity and steam would be built.

Integration of Ludu recycle centre, regional recycle company and the Processor of regenerated resources at Taicang Harbor Zone would form a resource cycle of bicycle industry.

An industrial water treatment and reuse works and several centralized waste water treatment plants for treatment of heavy metal wastewater, sewage and organics wastewater, instead of individual treatment station in each factory.



**FIGURE 3: An extended bicycle industrial network**

The methodology of multi-objective pinch analysis (MOPA) was tried to be applied in many factories' coating processes for VOC emission control, saving paints and solvent and to use waste solvent as fuel for heating, and practice cleaner production within a factory. This methodology was also considered as a tool for organizing inter-enterprise planning of mass and water flow networks. But the efforts have not been realized and the causation will be discussed in the Section 4.

(2) Promoting the use of environmentally friendly materials

- a) Application of durable materials, e.g. magnesium-aluminium alloy of bicycle framework, rim, spoke and handlebars.
- b) Using natural materials, e.g. natural rubber, instead of synthetic rubber which is made from petroleum.
- c) Taking advantage of recycled materials e.g. recycled aluminium, steels, and regenerated rubber etc.

(3) Eco-design of production processes

Cleaner production in plating processes and coating processes.

(4) Eco-design of recovery/regeneration systems

The average period of bicycle renewal was 15-20 years in China during 1980s but that has been 3-5 years in recent years. A great amount of obsolete or used bicycles has been a stress on environment. In the box B of figure 4 there is a lozenge, which is the step of test, examination and screening of the quality and usability of waste bicycles, parts or components, and then determine the directions of recovery or regeneration. If it is "Yes" then the waste return to Box A, but if it is "No" then the waste goes to secondary sorting, i.e.

a) Reuse as second hand bicycles sold in market;

b) Reuse of parts and components through coating or surface processing; and/or

c) Recycle of steel, aluminium alloy, rubber and plastic from waste bicycles, parts and components.

### **The planning of the Xinzhuang eco-industrial park (XEIP)**

#### ▪ *General situation*

The Xinzhuang industrial Park (XIP) is located at south-west of Shanghai, and middle west part of the Minhang District about 18 km from downtown area with convenient transportation. The establishment of XIP was approved by the municipality in 1995. The planned area of the zone was 13.6km<sup>2</sup>.

The permanent population of the zone was 16.7 thousands. Two hundred and sixty six manufacturers had settled in the zone by 2003, and among them 27 were the branches of transnational corporations ranked in Global 500, but most of them were SMEs. The total industrial output value of the zone was \$2.5 billion in 2003.

The pillar industries in the zone were microelectronics, machinery and automobile parts-accessories, new materials and precise chemical industries. Meantime a variety of other categories of industries were coexistent with pillar industries in the zone. Most tenant enterprises were privately owned and belonged to SMEs. Although there were many big enterprises in the zone it seems that building the eco-industrial chains and inter-enterprise mass, energy and water flow networks will issue a great challenge for the planning team, because over there were no capable anchor enterprises, and the enterprise entrance into the zone mainly was dependent on better geographic position and infrastructure conditions, and reputation of the zone. Besides above mentioned facts the information exchange among enterprises and park's administration was much less than what is needed.

#### ▪ *Basic frame of the planning*

Because the structure of industrial sectors and the layout of tenant enterprise in the park had been relatively fixed, the task of planning should focus on regulating unfitted enterprises, building more convenient infrastructure and tenant distribution.

The basic frame of the planning is shown in Fig.4, which included two aspects the technological work of eco-design and the software for management of an EIP.

To support the planning a huge data base is always needed, that involves in broad spectra of information in time series from local geographical data, industrial statistics of individual enterprise, environmental quality and pollution data, facts of socio-economic and management, etc. Because of practical limitations and institutional confinement, most information and data for this planning have not been available through the park's management bureau, local and state bureaus of statistics, and enterprises. The planning team had tried to carry out practical monitoring and/or measurements to collect

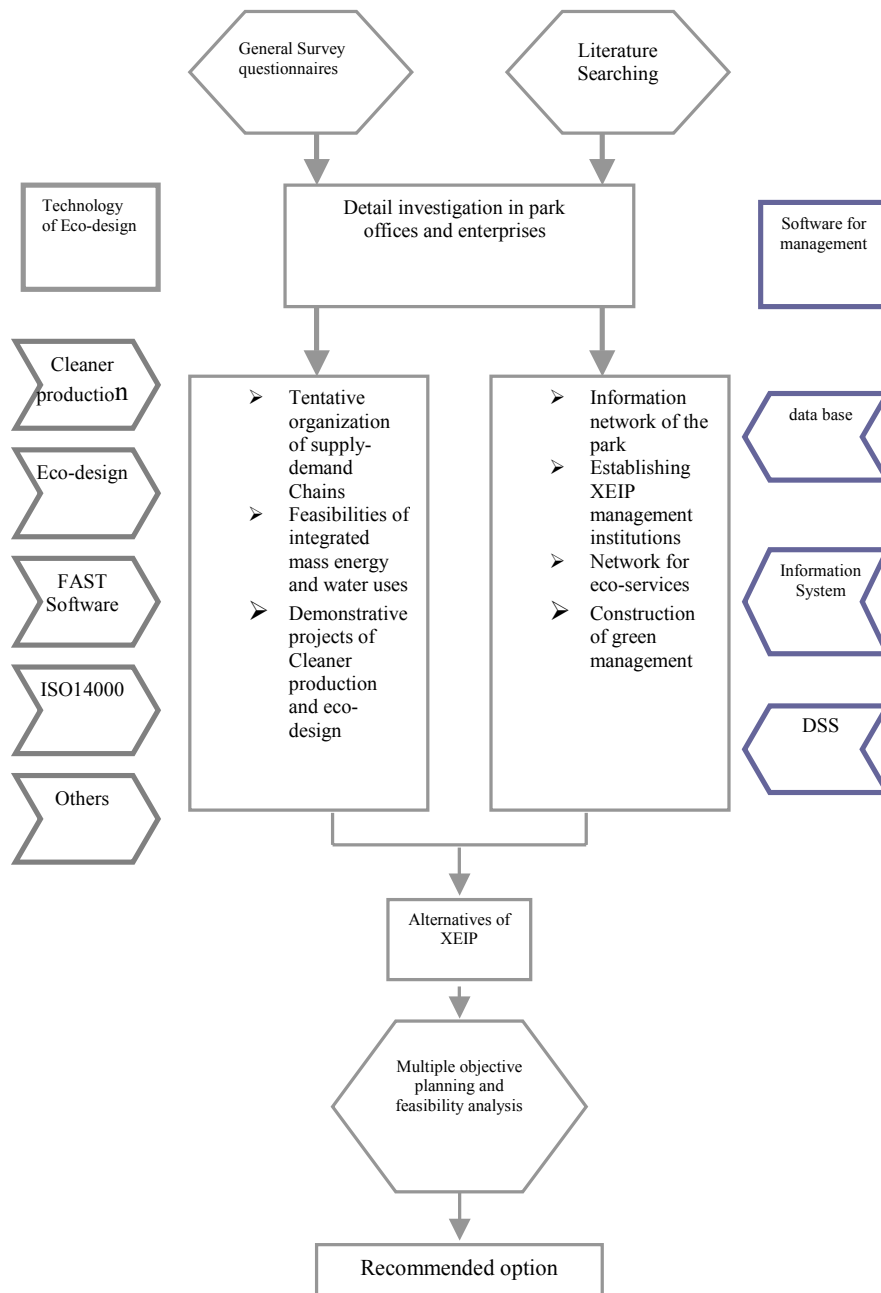
some data within the financial budget. The field survey and/or investigation were very helpful, but the collected data or information belonged to qualitative or fragmentary. Therefore the plan in general tended to be conceptual and heuristic.

- *Measures of inter-enterprise planning of dynamic mass and energy flow network in XEIP*

Some measures to organize dynamic mass and energy flow network were worked out through inter-enterprise planning.

(1) Cogeneration and centralized supply of steam and electricity.

Originally there were two heat centres at south and north of the park using coal as fuel and only supplying steam to users. Owing to institutional problem most SMEs are equipped with own boilers, and only a small portion of the heat centres' capacity was utilized.



**FIGURE 4: Basic frame of the planning**

In planning XEIP, the technological transformation of two heat centres into co-generation centres of steam and electricity. The smaller boilers in many SMEs would be obsolete through economic policy and ageing demolition by 2010. It could be expected that tenant enterprises will all use the steam from cogeneration centre for heating and cooling. The electricity produced by the centre will be sent to local electric network and to park's users. It was estimated that in this way fifty thousand tons of coal will be saved and  $150 \times 10^3$  tons of CO<sub>2</sub> emission will be cut down.

(2) Feasibility studies on the inter-enterprise planning of integrated VOC utilisation and treatment.

There were roughly twenty four thousand tons of organic solvents including toluene, Xylene and benzene expensed in the park annually.

Based on the park's statistics a part of solvents had been recycled, reused, burned and treated within the enterprises or manufacturers. For the purposes of increasing the efficiency of solvent usage and cutting down VOC emission several alternative of cleaner production measures as improving coating processes, increasing reuse rate of solvent and carbon adsorption efficiency, etc. were planned for enterprise's choice.

The inter-enterprise planning of integrated VOC utilization and treatment were very difficult to be drawn up on account of the existent layout of enterprises' distribution and the uncertainty of future change in industrial structure.

(3) Water reuse in the park

The plan had highlighted on enhancing water saving and wastewater recycling or reuse within enterprises in line with the state Law on Promotion of Cleaner Production. It was also difficult to organize inter-enterprise water reuse. Fortunately there were two microelectronics companies using reverse osmosis process to produce pure water. The concentrate water which amounted to 11,000m<sup>3</sup>/d from the process still could meet the reuse water standard and be used in irrigation, road and car washing, source of man-made pools, etc.

## ESSENTIAL PREREQUISITE TO MAKE THE PLAN EFFECTIVE

Five principles have been followed in the three case studies, i.e. readjusting park's layout and structure for the convenience of reconstruction of eco-industrial chains and enhancing efficiency; strengthening life cycle management of resource input and waste reuse; building the context to create a broad local community support and participation; promoting the application of advanced technologies in mass, energy and water saving and recycling; and driving the improvement of information services and the management of environment and safety. But it was often difficult to make the integration of principles and practical planning.

### Relationship of stakeholders

- *Initiatives of EIP planning*

Over the years the governments at different levels have actively pursuing the "Circular Economy (CE) attempting to increase resource efficiencies, reduce pollution and improve environmental quality. Building EIP is a necessary component of "CE". Local government leaders usually hold that EIP planning will lead an industrial park to rapid growth in economy, sound environment and healthy society without considering more real conditions and restriction.

- *Tenant enterprises*

Most tenant enterprises are usually satisfied with following the laws and meeting the environmental standards. Their attitude towards pollutant emission often depends on the strength of environmental bureau's monitoring inspection and severity of penalty.

Concerning material, energy and water economisation these enterprises have still held the balance of the investment to pay and profits to gain. Under current conditions, the taxes and market prices of the resources are too cheaper to move enterprises' motivation of saving raw materials, energy, water and reusing byproducts from other business sectors.

- *Neighbour community*

The neighbour community nearby is enthusiastic to promote IP into EIP, because it will improve local environmental condition, enhance employment and provide better infrastructure services.

The neighbour community also will be the base to support EIP construction with accommodation, a variety of living services, labour source, etc.

- *EIP planning team*

The team which is assigned to bear the responsibility of planning task, usually is from a university, research institute or consultant corporation. The EIP planning shall be a multidisciplinary team-work. Being limited by available funds for a EIP planning the team usually is organized within a university or research institute and impossible to organize a multi-institutional planning team to consider and carry out the planning from wide-ranging scope.

### **The prerequisite to a more effective EIP Planning**

The basic objectives to promote EIP planning are saving natural resources, pollution prevention, improving environmental quality, and making waste reduction, reuse and recycle. A variety of other objectives are also important but it will not be discussed in the paper.

Taking advantages of policy tools and strengthening the enforcement of existent laws and regulations should be the prerequisite to promote a more effective EIP plan.

- *Strengthening the monitoring and inspection of pollutant emission, effluent discharge and local environmental quality and making these information open in the public media or in internet.*

These measures sound like alarm bell to enterprises against relaxation of the environmental regulations and standards, and further to improve the performance in cleaner production and environmental protection..

- *Increasing the rates of pollution charges*

Pollutant discharge license system (PLS) probably is a more comprehensive system, in terms of polluter's pay and allowed quota of specific pollutant discharge in the world. But the charge rate of specific pollutant emission or discharge is too low to stimulate enterprises' impetus of pollution control. Besides, many pollutants such as toluene, xylene, VOC, Hg, etc. have not been listed in the inventory of emission charge. Many enterprises in IPs often prefer paying the charges to preventing pollution.

- *Regulating the resource prices and taxes*

Government subsidy for many resource development as coal, water, petroleum, heavy metals, etc. have been a long term policy for many years. The prices of water, electricity, coal, etc. are too low to cause strong repercussion on resource saving and reuse in economic sectors. Only if the resource reuse and recycle project would bring obvious profits to the enterprise as the Guitang Group in Case one and Xintai Alcohol Distillery in Taicang, generally the enterprises would not pay a great quantity of investment on these projects with uncertainty.

- *Deposit-refund system for solid waste management*

This is an effective policy for solid waste management and resource reuse. In the Ludu park's planning (case two) this policy will greatly encourage the used or waste

bicycle reclamation, and in the XEIP planning it also will enhance the reclamation of used electronic devices or facilities, and package materials. Currently the government has worked on drawing relative regulations.

- *Education and training*

This measure should be carried out parallel to the whole processes of planning and implementation of the EIP plan.

## REFERENCES

- Department of Science-Technology and Standards, SEPA, China, Collection of Circular Economy and Eco-Industrial Park Planning, Beijing: Chemical Industry Publisher, 2004. P.1-P15
- E.A Lowe Eco-Industrial Park Handbook for Asian Developing Countries, CA USA. Indigo Development RPP International Appendix 1: Case Profiles, Guitang Group Sugar Refinery, China, 1997
- Taicang Municipality and College of Environmental Science and Technology of Tongji University. Taicang Eco-city and Circular Economy Building Plan (2004-2020) (Part1: Government Document and Part2:Research Report),October,2004
- College of Environmental Science and Engineering of Tongji University, Environmental Planning of Ludu Town January, 2005
- College of Environmental Science and Engineering, Cleaner Production Audit Report for Xintai Alcohol Distillery Co. Ltd, Taicang City July,2004
- Xinzhuang Industrial Park Committee and Tongji University, Intermediate Report on the Development Planning of Shanghai Xinzhuang Eco-industrial Demonstrative Park (2005-2020) June, 2005





# OPTIMISATION BEYOND BEST AVAILABLE TECHNIQUES

**Jutta Geldermann**

University of Karlsruhe (TH), Germany

The catalogues of Best Available Techniques (BAT) play an essential role in the environmental policy, taking into account all environmental media (air, water, land) and energy consumption. Their techno-economic characterisation, however, is focused on larger installations. For the environmentally friendly process design, especially of Small and Medium Sized Enterprises in industrialising countries, specific methods are required. Thus, this paper presents the Multi Objective Pinch Analysis (MOPA) as a suitable approach especially for the investigation of industry parks. This combination of methods of process integration and Operations Research (OR) allows the consideration of a variety of economic and environmental process attributes for an integrated technique assessment.

## INTRODUCTION

Best Available Techniques (BAT) are an essential element in European environmental legislation as required by the Directive on Integrated Pollution Prevention and Control (IPPC 96/61/EG). In particular, the implementation of BAT should reduce waste generation and increase the efficiency of energy consumption. Due to the rapid growth of emerging economies and their increasing demand for resources, it is essential to include these countries and their special conditions in the development of new strategies for sustainable development. Especially approaches suitable for Small and Medium Sized Enterprises (SME) are required. The paper is structured as follows: First, the conditions in industrialising countries are briefly outlined. Second, the various applications of the pinch analysis as a systematic approach for resource efficiency in process design are introduced. Then, the combination of the various approaches of the Pinch Analysis are conjoint with a concept for Multi criteria decision support. The application of the presented approach dubbed Multi Objective Pinch Analysis (MOPA) is described in (Schollenberger and Treitz, 2005) in a later chapter.

## CONDITIONS IN INDUSTRIALISING COUNTRIES

In this section an overview of the prevailing conditions in industrializing countries is given providing the basis for an appropriate mapping and defining of the requirements for the methodology to be developed. Especially in industrializing countries that face different financial, environmental and industrial conditions compared to Europe, Japan or North America, a new methodology is needed to reflect these constraints.

### Financial Situation and Policy

Promoted by various initiatives, cleaner production strategies are being applied increasingly throughout Europe, with the aim of raising efficiency and preventing environmental damage. Closed loop approaches for the whole supply chain, life cycle assessments (LCA) of products and connected processes and techno-economic assessment methods are used to improve environmental performance. However, this approach is still maturing in industrializing countries, where evolving financial institutions do not value the extra environmental and social benefits cleaner production processes provide. Hence, financing is a key barrier to investment in cleaner production facilities (UNEP, 2003). In addition, the situation of economic and environmental policy and the trade

interweavement of industrializing countries reflect their special conditions and policy options. Local certification bodies in many countries are not accredited by the importing countries' authorities. In order to increase the possibility of international policies to succeed, a consideration of local conditions is required while still satisfying the environmental objective (Steenblik and Andrew, 2002).

### **Environmental Conditions**

Disparity of the economic development and the scarcity of some resources in relation to the population presents a challenge to the environmental policy of many industrializing countries. In addition to traditional environmental problems (such as deforestation, erosion, water shortage etc.) the generation of emissions, wastewater, solid waste, or noise contributes to the pollution of the environmental media air, water and soil. Therefore, with respect to a sustainable development of these countries, a significant improvement of their resource efficiency is crucial.

One major problem is air pollution from man-made sources, due to the increased use of fossil fuels (e.g. carbon dioxide (CO<sub>2</sub>) emissions), manufacturing processes and the use of chemicals, causing risk to both human health and the different environmental compartments. Reducing air pollution is a complex task. Whereas pollution reduction measures of pollutants like CO<sub>2</sub>, NO<sub>x</sub> and SO<sub>2</sub> in large industrial installations have been implemented comparably well via technology transfer, the pollution reduction measures of volatile organic compounds (VOC) are more problematic. Emitted VOC interact with nitrogen oxides (NO<sub>x</sub>) in the presence of sunlight to form ozone which is of major concern in both urban and rural areas. Some studies indicate that in China soy bean crops are reduced by 10% or more and spring wheat production by 20% and 3% respectively, in comparison with the potential production (ECON, 2002). Overall, more than 5.3 million hectares of land are estimated to be affected by air pollution in China with ozone pollution likely to increase in China in the years to come, due to several factors including growing numbers of motor vehicles and SME (ECON, 2002). In Chile the capital region of Santiago is especially affected by air pollution and has been declared a saturated zone in terms of ozone and three other contaminants. Thus, a decontamination plan must be executed for the region, and environmental impact assessments are obligatory for all industrial, urban or real estate projects.

Besides air quality, water pollution is of great importance to industrializing countries in order to guarantee public access to freshwater. Improved water resources management is necessary for most industrializing countries. Considerable health effects must be considered, but also significant effects to the structure of industrial applications can be observed. Insufficient wastewater regulations based on a central authority vs. a demand-oriented management can be observed. Furthermore, in China for example inequalities in water supply between western vs. the coastal and eastern regions lead to different water perception.

A third major concern is energy consumption. Taking into account the rising energy demand of industrializing countries, major improvements in efficiency and the incorporation of renewable energy sources are necessary. Furthermore, due to the highly regulated power supply in numerous countries the energy costs are commonly artificially fabricated prices reflecting energy policies. As a result, in most cases energy prices are below market prices and thus are not encourage energy saving measures.

### **Industrial Structures**

Besides general differences between Europe and industrializing countries, geographical conditions and differences in infrastructure can determine unequal develop-

ment within these countries. For example in China a disproportionate level of progress in the different regions. As true for the natural water and mineral resources, also the economic development of the eastern and coastal provinces outplays the underdeveloped western regions and inner Mongolia. Therefore, the 10<sup>th</sup> five-year plan (2001-2005) contains 225 projects furthering development in these regions with tax advantages, technological innovations and development of infrastructure (Staiger et al., 2003).

Comparable to the general situation of Latin America, Chile is characterized by a structural dualism. More than 98% of the companies are small businesses. The SME account for less than 25% of the total sales in the non-agricultural sector, but offer more than 80% of the employment (Troncoso, 2000). The SME in Chile are confronted with several disadvantages compared to large companies. Besides the well-known absent effects of the economies of scale, they have no access to international capital markets and must pay higher interest rates on the national market. Furthermore, the lack of skilled human resources affects the productivity of the SME in all sectors in Chile (Landerretche, 2002). Additionally, the numerous regional integration agreements signed by Chile with other countries result in a breakdown of protection measures for certain products and activities thus also affecting the productivity of SME (Schiff, 2002).

Taking into account all of these aspects the regional and global energy and material markets will be affected by growing economies and industrializing countries and vice versa. Thus, the success or failure of a sustainable, efficient and environmentally friendly development will impact the world's economy.

## **PINCH ANALYSIS APPROACH**

There are various approaches and terminologies aiming at the environmental improvement of production processes from the plant and firm level, to the inter-enterprise level (Geldermann et al., 2005c). Approaches such as pinch analysis and Process Integration Technology have a long tradition within chemical and process engineering for the systematic identification of cost- and resource-efficient production options. The challenge now is the optimal recovery and reuse of materials not only for single substances or energy flows in large chemical installations, but also for smaller production processes and various mass and energy flows.

Originally, the pinch analysis was developed for the design of heat exchanger networks, aiming at determining the best possible use of energy (Linnhoff and Flower, 1978). Today, problems addressing wastewater minimization (Wang and Smith, 1994, Mann and Liu, 1999) and VOC recovery from waste gas streams (Dunn and El-Halwagi, 1994, Zhelev and Semkov, 2004) can also be solved applying the pinch approach. The algorithms for solving the design problems have been developed further in the past years. Some case studies have been solved by applying algorithms from the field of Operations Research, for example the transport algorithm (Cerda et al., 1983, Geldermann et al., 2005a).

### **Thermal Pinch Analysis**

Today, the energy pinch analysis is a well established and mature design methodology and a systematic approach for the minimization of lost energy. In its first step the maximum of energy usable for heat recovery is calculated (Umeda et al., 1979). Hot and cold process streams are combined to form composite curves. A minimum temperature gradient  $\Delta T_{\min}$  must be set representing the driving force of the heat transfer. Heat can be exchanged between the hot and the cold streams of the investigated system. Further heating or cooling required by the system is provided by additional utilities

(Linnhoff and Flower, 1978). The result of the pinch analysis is the energy saving potential for the considered set of processes representing the target for the subsequent design process. Furthermore, information is obtained on the amount of heat exchange required between the appropriate streams minimising the use of hot and cold utilities. Depending on the chosen design constraints, which reflect technical and chemical requirements, the actual savings are determined resulting in an economically feasible solution.

The fact that optimality is sought with respect to heat recovery rather than costs might appear to be a disadvantage. However, since the overall costs are heavily dominated by the cost of energy all different networks which feature maximum heat recovery are suitable as starting networks for the design (Linnhoff and Flower, 1978). Consequently, the layout planning is driven by a trade-off between equipment (e.g. capital for heat exchanger) and operating cost (energy utility cost). Therefore, an analysis considering the costs for utilities and the effect of the temperature gradient to the required surface of the heat exchanger must be carried out. Finally, geometry (e.g. spiral and extruded finned tubes), material (e.g. stainless steel, titanium, or hastelloy<sup>®</sup>) and the size of the surface influence considerably the investment necessary for the realisation of the savings potential (Gregorig, 1973).

### **VOC Pinch Analysis**

The pinch analysis for VOC or multi-component VOC recovery is applied in a similar way to the energy pinch. Since the separation from waste gas is usually carried out via thermal condensation the problem can be transformed into a heat exchange problem (Dunn and El-Halwagi, 1994). On the basis of vapour pressure curves and heat capacities the amount of heat for heating and cooling can be calculated. Due to the fact that an almost complete condensation of solvents is possible in theory and therefore the optimal value for the recovery is 100 %, the system specific boundary conditions must be depicted from the beginning.

Therefore, the objective value of the analysis is set to be the recovery of a certain amount of the solvents by means of condensation at minimal annual costs. Additionally, specific constraints as e.g. legal thresholds for VOC-emissions or equipment parameters such as operating temperature ranges must be fulfilled. The released heat of the cooling of the flue gas can partly be taken up by the cold gas coming out of the condenser. Nevertheless, the required temperature gradient for the heat transfer and possible thresholds for the outlet temperature of the gas may limit the amount to be integrated directly. Thus, additional unit operations are needed for the supply of heat and the cooling (Parthasarathy and El-Halwagi, 2000).

The economically optimal solution of the analysis is driven by the trade-off between the costs for heat integration and further cooling and the savings achieved by the reuse or the selling of the condensed solvents. Hence, the consideration of equipment installation and operating costs as well as costs of coolants and new solvents is required. Depending on the specific cost structure and legal requirements, the solutions may differ between various countries according to their local conditions.

### **Water Pinch Analysis**

The principles of the pinch analysis can also be employed for optimising water consumption and other auxiliary materials as its goal is always to best possible reuse of the analysed resource, while adhering to the requirements of the process steps. Analogous to the application of the thermal pinch analysis approach, the water pinch analysis can be used primarily to calculate the target values based on either minimum fresh water

consumption or minimum wastewater generation that maximise water reuse in a network of various water streams (Mann and Liu, 1999)..

The first pinch analysis based approach focusing entirely on water minimisation was a graphical methodology by (Wang and Smith, 1994), targeted at minimal water and wastewater flow rates through the analysis of the concentration vs. the mass load of the different process streams. This water-quality approach is based on a mass exchange problem between a set of rich process streams and a set of lean process streams. Since unit operations with an unchanging mass load of the water stream (e.g. cooling tower) can only be mapped with difficulty by the concentration vs. mass load approach, a water-quantity approach with various modifications was originally developed based on the analysis of concentration vs. flow rates (Dhole et al., 1996). Furthermore, a conceptually different approach was developed by (Dunn and Bush, 2001) using stream mapping diagrams (composition vs. flow rate) or condition mapping diagrams (e.g. COD vs. flow rate), which focused on identifying different recycling possibilities of single streams rather than constructing composite curves.

The fundamental difference between the thermal pinch analysis and the water pinch analysis lies in the definition of the quality of a stream (Linnhoff, 2004). In a water pinch analysis the water quality is per se multi-dimensional and characterized by various parameters (e.g. COD, pH, suspended solids (SS), etc). If more than one quality parameter of the water streams is of significance to the processes they must be taken into account for the optimisation. Such "key contaminants" are defined as "any property that prevents the direct reuse of a wastewater stream" (Tainsh and Rudman, 1999). In fact an analysis for each key contaminant has to be executed and a design must be developed iteratively. Given that graphical approaches are generally quite complex for multi-parameter cases or distributed wastewater treatment systems, the use of mathematical methods is more appropriate.

## MULTI-CRITERIA DECISION SUPPORT

Process improvement on the basis of detailed process characteristics requires the simultaneous consideration of different mass and energy flows and often leads to a multi-criteria problem. In an integrated technique assessment selected alternative techniques (from the catalogue of Best Available Techniques (BAT) including emerging technologies) can be compared with the *status quo* by using multi criteria decision support (Geldermann et al., 1999). Such a comparison based on the calculated results of energy and water consumption, VOC-emissions and further criteria (e.g. operating costs or investment) can be achieved both by a metric or a formalised multi-criteria methodology, as being described in the following.

### Metric for Resource Efficiency

In general a metric defines a distance between two points and a norm describes the length of a vector and thereby induces a metric. Consequently, the relative distance of a technology to a target can be both used in a multi-criteria approach component-wise and be combined to an overall savings potential. Therefore, the assessment of the different technical options can be done using a metric based on a modified Euclidian norm (Treitz et al., 2004, Geldermann et al., 2005b).

The normed absolute distance  $d_{ix}^{\mu \text{ norm}}$  between attribute values  $r_{ix}^{\mu}$  and a target value  $r_{i \text{ pinch}}$  by each component  $r_1, r_2, \dots, r_n$  is the base for the assessment (cf. Equation (1)).

$$d_{i\lambda}^{\mu \text{ norm}} = \frac{|r_{i\lambda}^{\mu} - r_{i \text{ pinch}}|}{|r_0^0 - r_{i \text{ pinch}}|} \quad (1)$$

The component-wise distances  $d_{i\lambda}^{\mu \text{ norm}}$  are weighted by their factors  $w_i$  of relative importance and added up squared (cf. Equation (2)). In this way the metric is a classical, compensatory, additive multi-criteria model.

$$d_{i\lambda}^{\text{norm}} = \sqrt{\sum_{i=1}^n (w_i \cdot d_{i\lambda}^{\mu \text{ norm}})^2} \quad (2)$$

Consequently, the overall savings potential  $\delta_{MOPA}$  of a technology can be expressed as a percentage of the distance of the *status quo* to the target values (cf. Equation (3)).

$$\delta_{MOPA} = \frac{d_0^{\text{norm}} - d_{\lambda}^{\text{norm}}}{d_0^{\text{norm}}} \quad (3)$$

It is important to note, that even if the domain  $D$  (cf. FIGURE 1) of considered technology is continuous, the metric only compares discrete technology combinations within the domain  $D$ .

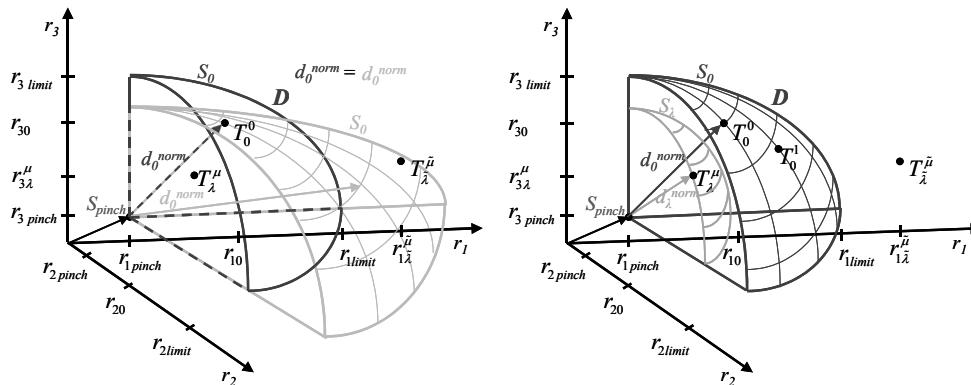


FIGURE 1: Domain  $D$  of considered technology combinations  $T_{\lambda}^{\mu}$

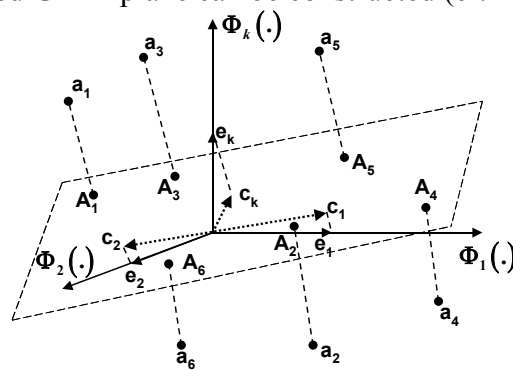
The shape of the domain  $D$  clearly depends on the weighting factors  $w_i$  and is prolonged in the direction of the less weighted component (i.e. criterion). Thus, if a technology combination is considered in a relative assessment depends on the importance of the different criteria (cf. technology combination  $T_{\lambda}^{\mu}$  in FIGURE 1 left vs. right).

### Multi Criteria Analysis with PROMETHEE

Another approach for the comparison of different technical options is a formalised multi-criteria methodology either based in a classical way on value functions (such as multi attribute value/utility theory (MAVT/MAUT)) or based on pair-wise comparisons of the different techniques in an outranking approach (such as PROMETHEE or ELECTRE). To investigate the technologies and execute sensitivity analyses the outranking approach PROMETHEE (Brans and Mareschal, 2005) is proposed. It facilitates the acquisition of new insights into the problem by examining the possible alternatives,

receiving support for the definition of its value judgements, possibly creating new alternatives or identifying the requirements of further criteria and data (Treitz et al., 2005).

Using PROMETHEE a ranking of alternatives can be calculated based on the attribute values and the value judgments of the decision maker. Considering all these aspects it is important to carry out sensitivity analyses to iteratively re-model the decision problem and to facilitate learning about it. Several sensitivity analyses can be carried out. On the one hand the robustness of a decision can be investigated globally by changing the weighting of one criterion from zero to 100%. On the other hand the robustness of the parameters  $q$ ,  $p$ , and  $s$  of PROMETHEE (cf. (Brans and Mareschal, 2005)) can be locally investigated by carrying out a Monte Carlo Simulation using specific uncertainty levels (e.g.  $\pm 10\%$ ) or by evaluating all possible preference type combinations (cf. (Treitz et al., 2005)). Another approach is the Principal Component Analysis (PCA). By projecting the cloud of alternatives from the  $R^n$  onto the plane of the first two principal components the so-called GAIA plane can be constructed (cf. FIGURE 2).

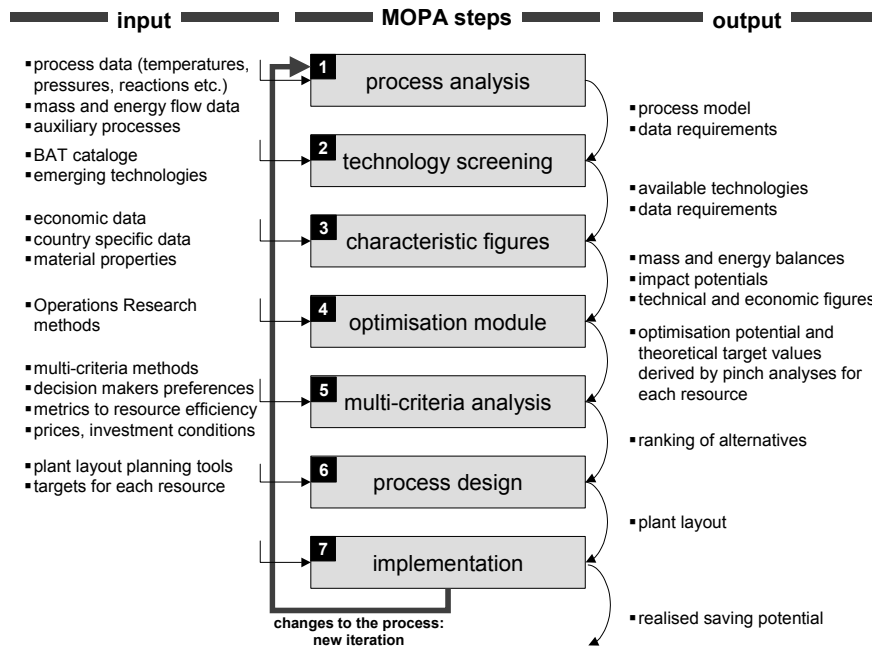


**FIGURE 2: Projections on the GAIA Plane (Brans and Mareschal, 2005)**

Apart from alternatives and criteria axes, the weighting vector (the PROMETHEE decision stick  $\pi$ ) can be projected on the GAIA plane. By defining upper and lower bounds for each weight the convex hull of all valid weighting combinations can be projected on the GAIA plane, visualising the range of  $\pi$ , i.e. the PROMETHEE VI area. Furthermore, if attribute values are characterised by a specific uncertainty level, a scatter plot based on a Monte Carlo Simulation can be displayed (cf. (Treitz et al., 2005)) that visualises the distinguishability between all alternatives (Basson, 2004).

## MULTI OBJECTIVE PINCH ANALYSIS

The framework of Multi Objective Pinch Analysis (MOPA) comprises all the different aspects discussed so far (cf. FIGURE 3). Based on the current process design and technological and legal environment, alternative unit operations are included by the catalogue of Best Available Techniques and a screening of emerging technologies. The process characteristics, economic and country specific data are used to determine the optimisation potentials and the targets for the assessment. Different technological options are compared on these grounds leading to a design recommendation. The implementation determines the savings potential finally realised.



**FIGURE 3: Framework of the Multi Objective Pinch Analysis (Treitz et al., 2004)**

Depending on the system boundaries MOPA can be used within a single company, but also in production networks, supply chain structures or industry parks. As a matter of principle inter-enterprise approaches especially challenge the involved companies to implement measures affecting the company considerable (cf. (Tietze-Stöckinger, 2005)). However, focus of MOPA is the technical scope and feasibility over the organisational or financial questions. Case studies in Chile and China (Schollenberger and Treitz, 2005) demonstrate the applicability of the developed methodology within companies. But newly established industry parks, the ambition to be certified as an eco-industry park and the relocation of various companies open the possibility to develop design alternatives beyond the boundaries of a single company.

The first step is a model of a virtual industry park, where the substance and energy flows of several companies are merged in a model with extended system boundaries. Hence, different operations and processes are treated as one company. In this case, additional constraints such as spatial distance of the installations must be taken into account, especially for the determination of economic feasible solutions.

## SUMMARY

The energy pinch analysis is a well established and mature design methodology and a systematic approach for the minimization of lost energy in the chemical industry. It has been expanded for the investigation of VOC and water streams for certain industrial processes. The challenge for industrial production is now the integration of these approaches for an overall resource efficiency. After the determination of the optimisation potential for the energy, VOC- and water streams within a production network and the respective theoretical target values derived by pinch analyses for each resource, a multi criteria decision support helps to select the most suitable compromise solution, taking into account the specific local circumstances.



**REFERENCES**

- Basson, L., 2004. Context, Compensation and Uncertainty in Environmental Decision Making, Ph. D Thesis, Department of Chemical Engineering, University of Sydney, Sydney.
- Brans, J.-P., Mareschal, B., 2005. PROMETHEE Methods, In: Figueira, J, Greco, S, Ehrgott, M (Eds.), Multiple Criteria Decision Analysis - State of the Art Surveys, Springer, New York, pp. 163-195.
- Cerda, J., Westerberg, A., Manson, D., Linnhoff, B., 1983. Minimum utility usage in heat exchanger network synthesis - A transportation problem, *Chemical Engineering Science* 38 (3), pp. 373-387.
- Dhole, V. R., Ramchandi, N., Tainsh, R. A., Wasilewski, M., 1996. Make your process water pay for itself, *Chemical Engineering* 103 (1), pp. 100-103.
- Dunn, R. F., Bush, G. E., 2001. Using process integration technology for CLEANER production, *Journal of Cleaner Production* 9, pp. 1-23.
- Dunn, R. F., El-Halwagi, M., 1994. Optimal design of multicomponent VOC-condensation systems, *Journal of Hazardous Materials* 38 (1), pp. 187-206.
- ECON, C. f. E. A., 2002. Environmental challenges in China: determinants of success and failure, Commissioned by The World Bank, Oslo.
- Geldermann, J., Jahn, C., Spengler, T., Rentz, O., 1999. Proposal for an Integrated Approach for the Assessment of Cross-Media Aspects Relevant for the Determination of "Best Available Techniques" BAT in the European Union, *International Journal of Life Cycle Assessment* 4 (2), pp. 94-106.
- Geldermann, J., Treitz, M., Rentz, O., 2005a. Integrated technique assessment based on the pinch analysis approach for the design of production networks, *European Journal of Operational Research*.
- Geldermann, J., Treitz, M., Schollenberger, H., Rentz, O., 2005b. Plant Layout Planning based on Multi Objective Pinch Analysis, 12th SETAC Europe LCA Case Studies Symposium and European Meeting of the International Society for Industrial Ecology, Bologna, pp. 63-66.
- Geldermann, J., Treitz, M., Schollenberger, H., Rentz, O., 2005c. Modeling and Integrated Assessment of Mass and Energy Flows within Supply Chains, *Research Methodologies in Supply Chain Management*, Physica-Verlag, Heidelberg, pp. 573-587.
- Gregorig, R., 1973. Wärmeaustausch und Wärmeaustauscher : Konstruktionssystematik, Serienproduktion, Rohrschwingungen, fertigungsgerechte wirtschaftliche Optimierung aufgrund von Exergieverlusten 2, Sauerländer, Aarau.
- Landerretche, O., 2002. El Fomento de la Pequeña y Mediana Empresa y los Desafíos de la Globalización, *Colección Ideas Año 3* (25), Fundación Chile 21.
- Linnhoff, B., 2004. Mit der Pinch-Technologie Prozesse und Anlagen optimieren - Eine Methode des betrieblichen Energie- und Stoffstrommanagements *Industrie und Gewerbe* 9, Landesanstalt für Umweltschutz Baden-Württemberg, Karlsruhe.
- Linnhoff, B., Flower, J. R., 1978. Synthesis of Heat Exchanger Networks: I, Systematic Generation of Networks with Various Criteria of Optimality, *AIChE J.* 24, pp. 633.
- Mann, J. G., Liu, Y. A., 1999. *Industrial Water Reuse and Wastewater Minimization*, McGraw-Hill, New York.
- Parthasarathy, G., El-Halwagi, M., 2000. Optimum mass integration strategies for condensation and allocation of multicomponent VOCs, *Chemical Engineering Science* 55, pp. 881-895.
- Schiff, M., 2002. Chile's Trade and Regional Integration: An Assessment, *The World Economy* 25, pp. 973-990.
- Schollenberger, H., Treitz, M., 2005. Application of Multi Objective Pinch Analysis, In: Geldermann, J, Treitz, M, Schollenberger, H, Rentz, O (Eds.), *Challenges for Industrial Production - Workshop of the PepOn Project: Integrated Process Design for Inter-Enterprise Plant Layout Planning of Dynamic Mass Flow Networks*, Universitätsverlag Karlsruhe, Karlsruhe, pp. 117-126.
- Staiger, B., Friedrich, S., Schütte, H.-W., 2003. *Das große China Lexikon*, Primus Verlag, Darmstadt.
- Steenblik, R., Andrew, D., 2002. Trade and environment, *Observer* 233.
- Tainsh, R. A., Rudman, A. R., 1999. Practical techniques and methods to develop an efficient water management strategy, IQPC Conference: "Water Recycling and Effluent Re-Use".
- Tietze-Stöckinger, I., 2005. Kosteneinsparpotenziale durch Erweiterung der Systemgrenzen, *Universität Karlsruhe (TH)*, Karlsruhe.
- Treitz, M., Schollenberger, H., Bertsch, V., Geldermann, J., Rentz, O., 2004. Process Design based on Operations Research: A Metric for Resource Efficiency, *Clean Environment for All: 2nd International Conference on Environmental Concerns: Innovative Technologies and Management Options*, Xiamen, P.R.China, pp. 842-853.
- Treitz, M., Schollenberger, H., Geldermann, J., Rentz, O., 2005. Multi-Criteria Decision Support in Process Design, *International Transactions in Operational Research*.
- Troncoso, J., 2000. CORFO: The Chilean Economic Development Agency, *Economic Development Review Spring 2000*, pp. 45-48.

Umeda, T., Harada, T., Shiroko, K., 1979. A Thermodynamic Approach to the Synthesis of Heat Integration Systems in Chemical Processes, *Computers and Chemical Engineering* 3, pp. 273-282.

UNEP, 2003. *Cleaning Up: Experiences and Knowledge to Finance Investments in Cleaner Production*, Division of Technology, Industry and Economics, Paris.

Wang, Y. P., Smith, R., 1994. Wastewater Minimisation, *Chemical Engineering Science* 49 (7), pp. 981-1006.

Zhelev, T. K., Semkov, K. A., 2004. Cleaner flue gas and energy recovery through pinch analysis, *Journal of Cleaner Production* 12, pp. 165-170.

# **ECO ENGINEERING – AN ENGINEERED METHODOLOGY FOR SUSTAINABLE PROCESS IMPROVEMENT IN CHEMICAL AND PHARMACEUTICAL INDUSTRY**

**Nikolaus Thissen**

Ciba Specialty Chemicals Inc., Pratteln, Switzerland

Ciba® Environmental Services has developed a six-step-methodology for environmental projects named ECO Engineering. this methodology is described based on an example in the field of environmental technology. For the reduction of gaseous emissions by in- and end-of-process measures initially a detailed problem analysis is done in two steps, from which a clear target definition results. In the next phase the previously elaborated information is evaluated and a concept design based on scenario variation is done. The last action, after carrying out the measures, is a target control.

The detailed example from one of Ciba Specialty Chemicals's production sites shows how - by in- and end-of-process measures - a massive reduction of the initial emissions was reached. The result of this systematical work, which Environmental Services also carries out for third parties, was a dramatic reduction of the investment cost as well as a sustainable reduction of primary energy consumption and as a consequence, operating cost and secondary emissions (CO<sub>2</sub>, etc.) for a waste gas treatment system.

## **INTRODUCTION**

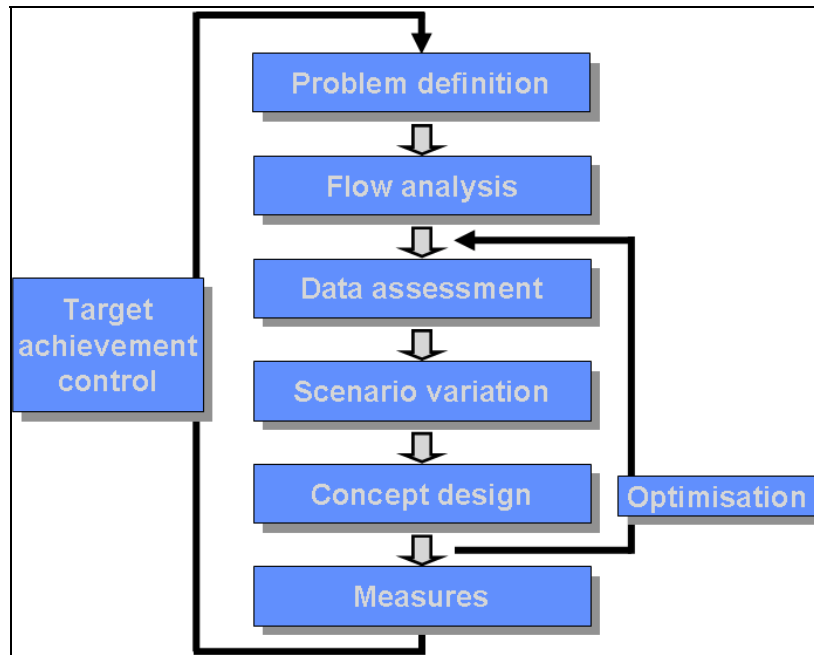
Chemical production plants handle a variety of materials like raw materials, intermediates and end products as well as energies and wastes like waste air, waste water, solid waste etc. All these materials may have an economical and ecological impact on the result of the production process. The most important measure for emission reduction of course is the development of emission free processes. However this is approach is limited by chemical and physical laws.

Assuming that this first and best way is not available it may be possible to reduce emission to a minimum by suitable strategic, technical and organizational measures in- and end-of-process. This may also have positive effects on a possibly required end-of pipe technology (EOP) in terms of investment cost as well as an increase of the eco-efficiency of the production plant and a reduction of secondary emission.

## **THE ECO ENGINEERING METHODOLOGY**

Based on longstanding practical experiences Ciba Environmental Technology developed a six-step-methodology named "ECO Engineering". This methodology is used for projects on sustainable process improvement regarding environmental problems.

Based on this methodology the first two steps consist of a detailed analysis of the total system including production facilities as well as EOP equipment (Figure 1). A very important point of this first phase of problem analysis is to clearly define the targets of the project e.g. in terms of technical parameters to be reached (such as emission limits, energy savings etc.).



**FIGURE 1: ECO Engineering Methodology**

This analysis is followed by a second (three steps) phase of solution finding by development of alternative proposals for improvement. In practice the three steps a) data assessment, b) scenario variation and c) concept design are carried out more or less in parallel and interconnected.

The last phase contains decision making and carrying out the before developed measure(s).

A repeated loop through the three steps of solution finding – for example in case of required optimisation of already developed solution(s) may be necessary. After all measures are carried out the target achievement is controlled. If the target is achieved the project is finished. Otherwise the sequence of ECO Engineering is worked through again – possibly in shorter time.

The examples presented shall illustrate in more detailed what ECO Engineering means in practice.

## **EMISSION REDUCTION BY ECO ENGINEERING**

Several years ago Ciba Specialty Chemicals has taken over a chemical production site where intermediate products were produced on two production lines. The raw materials as well as the products of these processes contain organic compounds of different composition. Based on their properties and the thermodynamic process conditions gaseous emission (VOC) aroused.

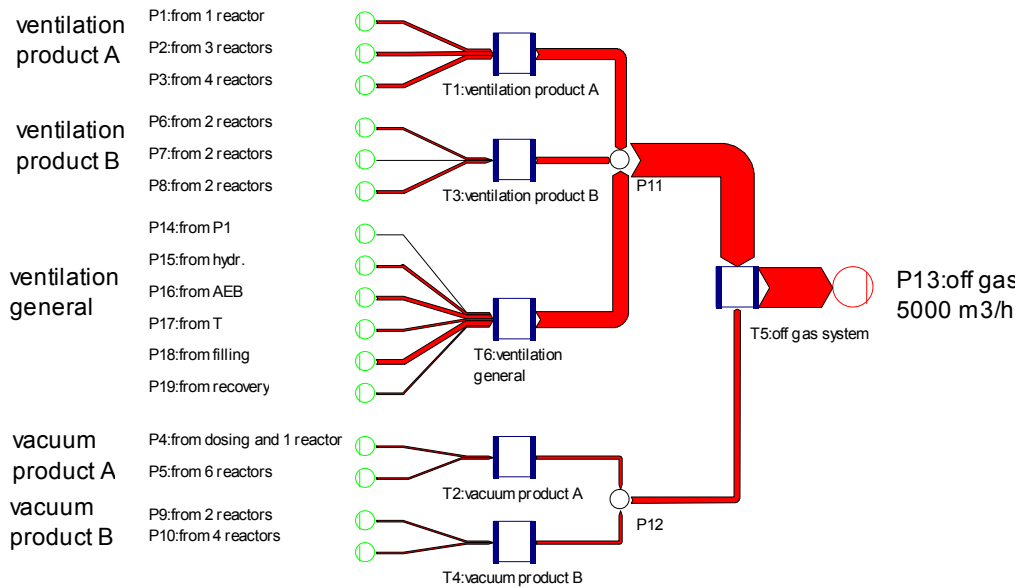
In the past gaseous emissions from the production processes were collected together with waste air from other sources into one waste gas stream. After treatment in an existing system this stream was released to the environment.

As time went by changes in the production processes created contamination in the surroundings of the site. Since there was also a tightening up of the environmental limits reworking of the venting system starting from the reactors was required.

### **Problem Definition**

In close cooperation with the operators team of both production lines and the engineers a stocktaking was carried out using the methods “situation analysis” and

MEFA. One of the very important results of this analysis was the fact that the main off gas flow rate of 5,000 m<sup>3</sup>/h was created by five partial streams (Figure 2), of which:



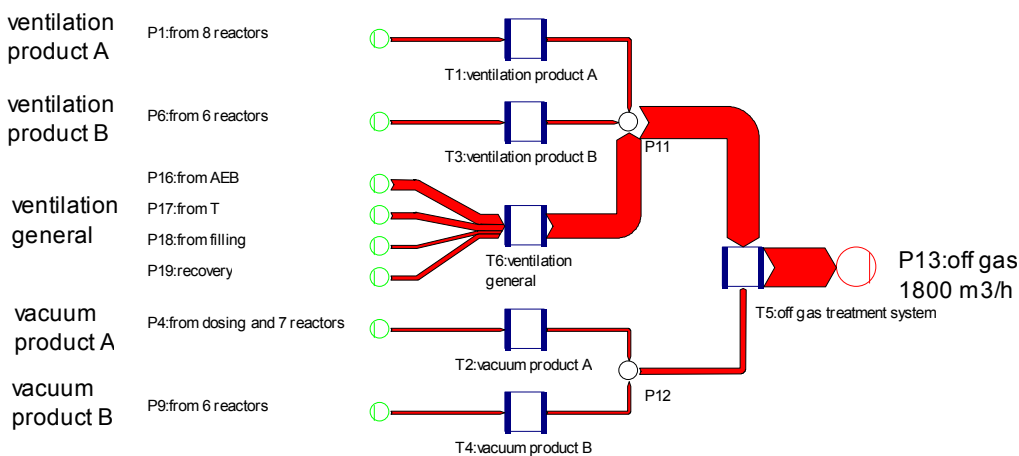
**FIGURE 2: Initial Off Gas System**

- *two high VOC loaded small flows from the vacuum systems*
- *two low loaded big flows from the process ventilation system*
- *one low loaded big flow from the general building ventilation system*

The whole off gas system was characterised by a high number of sources as well as high fluctuations of flow rates and pollutant concentrations, created by batchwise operated processes.

### Solution Finding

As the main reduction potential was expected in the ventilation system, main focus was now on the next, solution finding step. Out of only organizational measures a scenario with a reduced flow rate of approx. 1,800 m<sup>3</sup>/h resulted (Figure 3).



**FIGURE 3: Off Gas System after Organizational Measures**

Essential organizational measures were:

- *elimination of aspiration places not any longer needed*
- *reduction of flow rates to the effective local needs*
- *specific training of the production staff*

On single flows that were assumed to be critical, detailed information about VOC concentrations were collected, either by detailed calculations or, where necessary, by measurements. It was possible to differentiate two streams: A small flow rate with high VOC concentration and a big flow rate with low VOC concentration.

In summary the following data were found (Table 1 and 2):

**TABLE 1: Off Gas from Vacuum System**

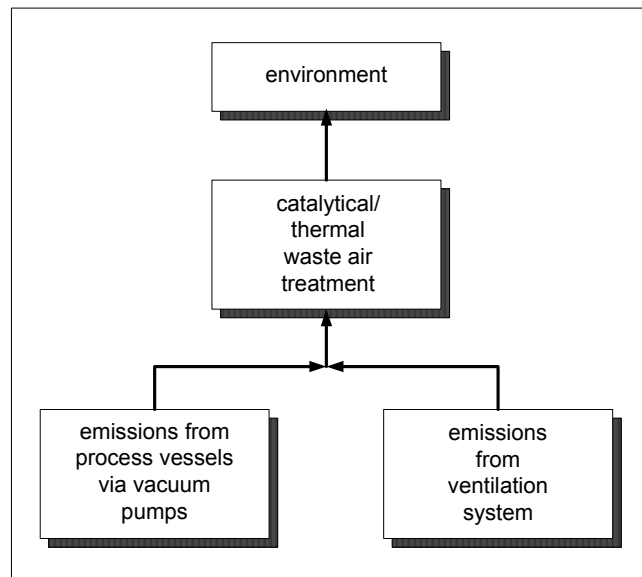
Flow rate	300 m <sup>3</sup> <sub>N</sub> /h max.
VOC concentration	5,1 g/m <sup>3</sup> <sub>N</sub> max.
Others	Odour-intensive organic acids
CO <sub>2</sub>	Approx. 1 Vol.-% max.
H <sub>2</sub> O	Approx. 20 g/kg max.
Temperature	Approx. 80 °C max.

**TABLE 2: Off Gas from Ventilation System**

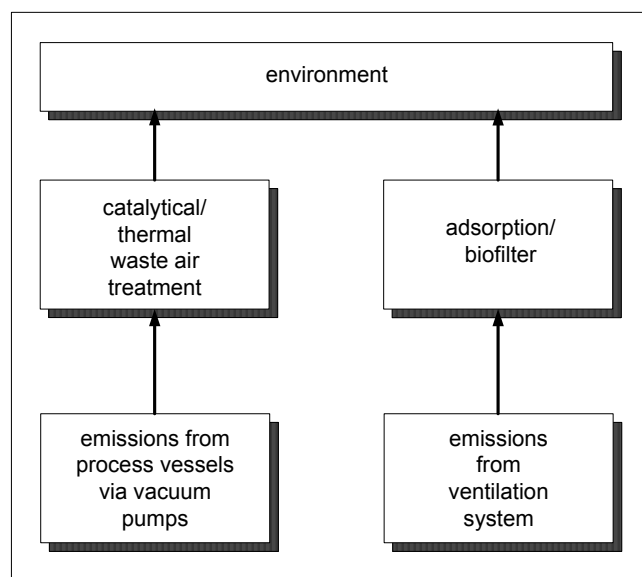
Flow rate	1500 m <sup>3</sup> <sub>N</sub> /h max.
Odour problem	Odour-intensive organic acids
Solids	Traces of benzoic acid possible
Others	unknown
Humidity	Ambient humidity mainly
Temperature	Ambient temperature mainly

The differentiation into two main streams resulted in two different treatment strategies:

- *joint treatment of both flows in one universal process (concept 1)*
- *separate treatment of both streams in optimum adapted systems for each stream (concept 2)*



**FIGURE 4: Joint Treatment Concept (Concept 1)**



**FIGURE 5: Separate Treatment Concept (Concept 2)**

The concepts mentioned in Figure 4 and 5 were worked out during a general concept design. With respect to the emission limits a thermal or catalytic incineration system was figured out for the joint treatment of both streams.

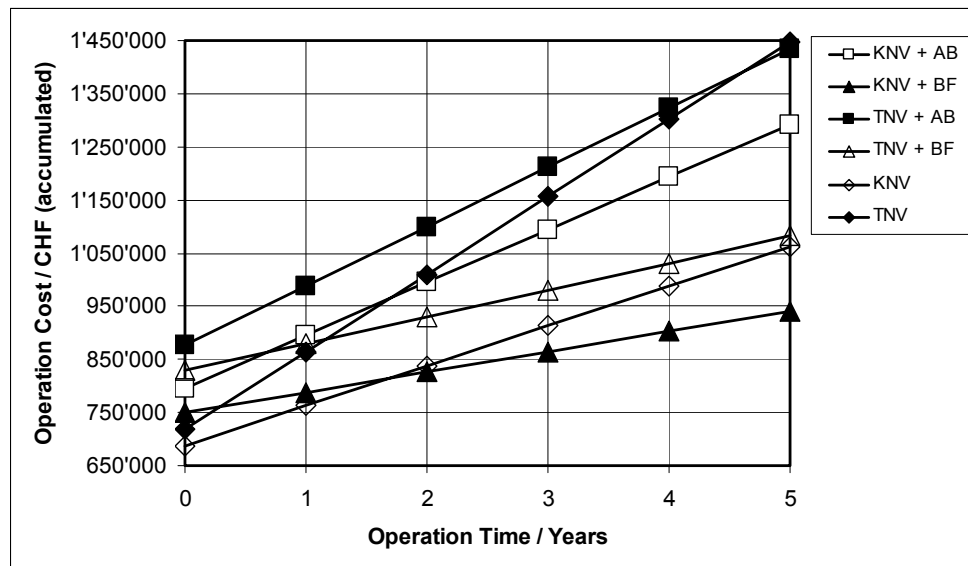
Considering the tough emission limits a thermal or catalytic incineration system may be the solution of choice for the high VOC loaded off gas, while the low polluted waste air may also be treated by technologies like absorption or biological treatment (concept 2).

Table 3 shows the results of a first rough investment cost estimation for different combinations of treatment systems including also the internal engineering cost.

**TABLE 3: Investment Cost of Various Treatment Systems**

Concept version	Investment cost / CHF
Concept 1: catalytic incineration (KNV)	690,000
Concept 1: thermal incineration (TNV)	720,000
Concept 2: catalytic incineration + absorption (KNV + AB)	800,000
Concept 2: catalytic incineration + biofiltration (KNV + BF)	750,000
Concept 2: thermal incineration + absorption (TNV + AB)	880,000
Concept 2: thermal incineration + biofiltration (TNV + BF)	830,000

In fact already based on investment cost some technologies were preferable, but for a better decision also the operating cost had to be considered (Figure 6).

**FIGURE 6: Comparison of Lifetime Cost (5 Years Approach)**

At this point catalytic incineration for the joint treatment of both streams became the most preferred solution, while catalytic incineration in combination with biofiltration was the favourite for the separate treatment.

Even if at this point already a high flow rate reduction had been achieved, with respect to the still very high cost it was decided to further optimize the process, strongly involving the production engineers.

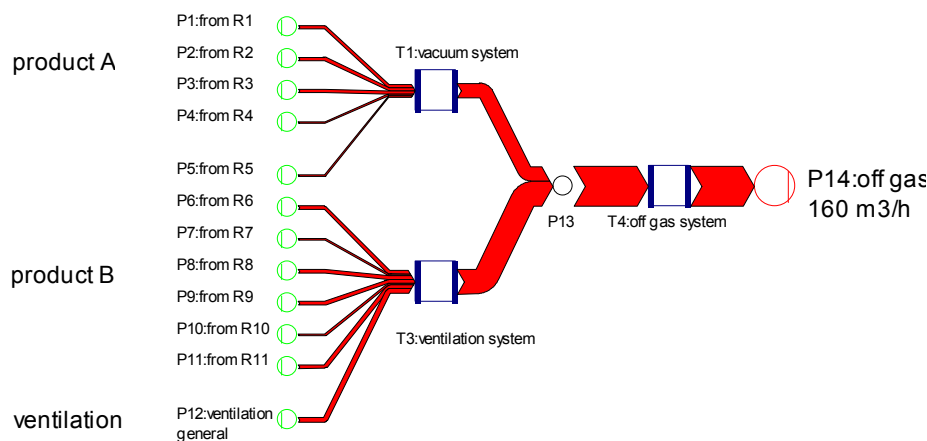
### Solution Finding - Optimization

In order to further optimize the measures worked out before in a second loop of solution finding («optimization», see Figure 1) now mainly technical measures were investigated:



- *modelling of the dynamics of single process steps (avoidance/reduction of emission peaks)*
- *modelling of the temporal order of process steps to each other (avoidance of simultaneous emissions)*
- *closed (instead of open) reactor loadings*
- *closed drumming of products*
- *limitaion of the flow rates from vacuum pumps*
- *modification of incapsulations to avoid continuous inertisation flows (pressure hold)*
- *installing nitrogen circulations instead of continuous N<sub>2</sub>-addition*
- *material transfer via pumps instead of nitrogen pressure*
- *temperature reduction*
- *pressure optimization*

Through consequent realization of all worked out measures, supported by the cost pressure finally a solution was found which satisfied all involved parties. The total flow rate which finally has to be treated has been reduced to approx. 160 m<sup>3</sup>/h (Figure 7), from originally 5,000.



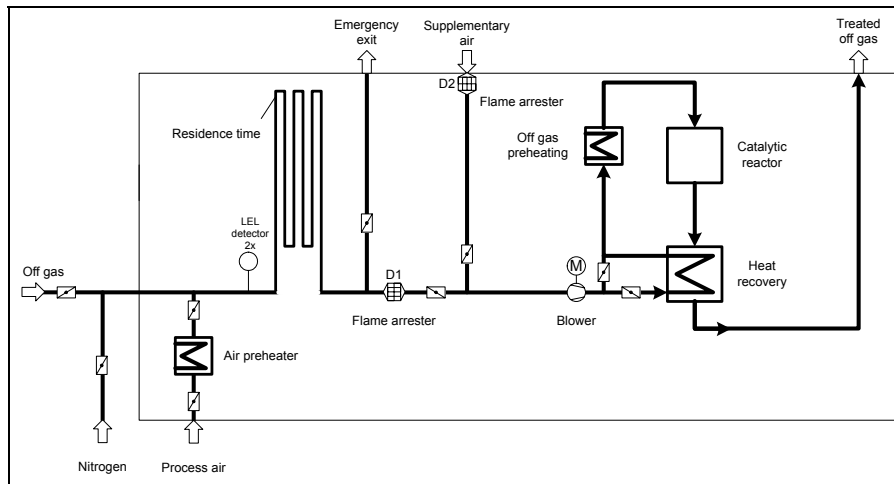
**FIGURE 7: Off Gas System after Organizational and Technical Measures**

### Decision and Measures

To safely meet and maintain the legal requirements from the available EOP technologies finally a small and effective catalytic incineration system was selected (Figure 8).

After start up it was found that over 70 % of the time the system operates under autothermic conditions. This means that in this mode there is no need for additional energy. Thanks to the catalyst the enthalpy of the off gas is high enough to reach the required reaction temperature.

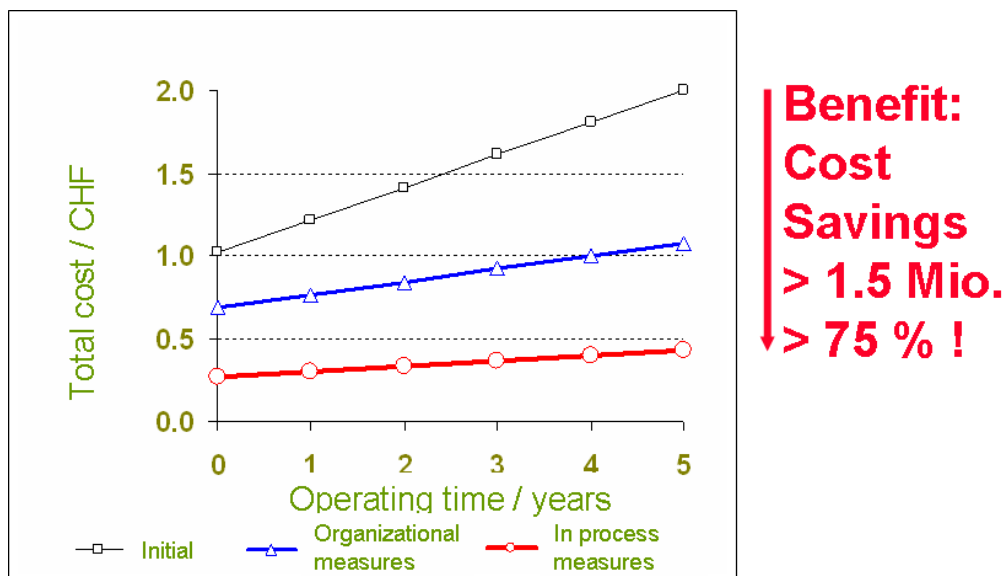
The consequences are sustainable low energy consumption and with this low secondary emissions (CO<sub>2</sub> etc.) and low operating cost.



**FIGURE 8: Off Gas Treatment System**

### Situation after the Project

The result of this systematical approach, which on demand Environmental Services also carries out for third parties, was a dramatic minimization of the waste air flow of approx. 97 % compared with the initial situation and a reduction of the total cost over the first 5 years of 75 % compared to the cost for an EOP technology without process optimization (Figure 9).



**FIGURE 9: Development of Cost during the Project (5 years approach)**

### Conclusion

This example impressively confirms the benefit of Cibas long term experience in this field: Sustainable solutions with low total cost can be achieved normally only with a combination of different organizational and technical measures. A well structured way to analyze the problem and to find attractive solution is a must for a successful project. Simple end-of-pipe solutions are normally too expensive and not sustainable.

The next section demonstrates some more short examples which underline the advantage of the structured methodology ECO Engineering.

## MORE EXAMPLES

### Energy Recovery from Liquid Solvent Waste

Approx. 7,700 to/year of liquid waste from several production lines had to be disposed off in an external incineration which created high annual cost. The main content of this liquid waste was organic solvents with some by-products like water, ammonia and traces of halogenated hydrocarbons.

Due to the high cost for the external disposal Environmental Technology was asked to investigate the situation on site with the general target to improve the situation regarding environmental impact, energy consumption and cost.

A mass and energy flow analysis (MEFA) was worked out for the whole production area being involved. The result was a mass and energy flow model which served as basis for the examination of different possible solutions. In cooperation with the site engineers and production team it was decided to utilize the energy content of the liquid waste for the production of steam in an on site steam generator.

Modelling of the liquid waste collecting and handling system showed that approx. 80 % of the liquid waste may be used as substitute fuel in the steam generator on site. The remaining approx. 20 % contain too high concentrations of halogenated hydrocarbons and have to be disposed externally also in the future. The substitution of natural gas by the waste solvent resulted in energy savings of approx. 40 % for the steam generator. In addition equivalent savings of primary energy resources and secondary emissions (CO<sub>2</sub>, pollutants) were achieved.

As a side result it was detected that with the liquid solvent 35 to/year of product were disposed off. Some simple technical and organizational modifications allowed to reduce this product loss to 12 to/year.

### Nitrogen Consumption of a whole Chemical Production Site

Several problems occurred at the nitrogen supply network of a chemical production site:

- *continuously increasing nitrogen consumption*
- *In addition, consumption peaks were satisfied by very expensive liquid nitrogen*
- *decreasing supply safety for the production plants as the maximum capacity of the nitrogen supply network was reached.*

Because of this supply risk and the fact, that several times already production processes had been shut down due to low nitrogen pressure, the intention was to build a new nitrogen supply system. Due to the high expected cost of this solution Environmental Technology was asked for support to work out and investigate an alternative solution.

A pilot project was initiated with the target

- *cost reduction*
- *increasing the general supply safety*
- *simplification of the supply network*
- *reduction of the nitrogen consumption*
- *planning the future additional nitrogen consumption*

A pilot project was carried out in one production building with two independent production lines. Every single nitrogen consumer was investigated regarding consump-

tion and reduction potential. This was done with the help of a detailed mass flow analysis. The result of this investigation showed that simple technical modification allowed for approx. 15 % nitrogen savings.

It was decided to extend the project over the whole site. This project is now under work.

### **Waste Air System of a Paint Producer**

The VOC concentration in a waste air flow of 20,000 m<sup>3</sup>/h coming from two different production areas of a paint producer exceeded the local limits by a factor of 10. Thus this customer was forced from the authorities to improve the situation and reduce the VOC emission dramatically. His first idea was to install an EOP plant, which was cost intensive regarding investment and operation due to the high flow rate. Beside that high CO<sub>2</sub> emissions were expected from its operation.

Ciba Environmental Technology was asked to improve the situation. A feasibility study aimed at estimating the reduction potential. showed that a reduction of the flow rate to 8,000 m<sup>3</sup>/h might be possible. To reach this target several organisational and technical measures would have had to be done.

The emission reduction project was then carried out, again using the ECO Engineering methodology. The result of this work was that a minimization of the flow rate to 6,500 m<sup>3</sup>/h by mainly organizational but also some low costing technical measures might be possible.

In cooperation with the customer to was decided to carry out all necessary measures and, due to internal needs of the paint producer, to install a regenerative thermal incineration system for 8,000 m<sup>3</sup>/h. This results in low energy consumption and also lower CO<sub>2</sub> and secondary pollutants emission. As the flow rate of the new system is far below the initial "solution" also the mass flow of residual VOC to environment is reduced dramatically.

Last but not least: The investment cost for the final solution were more than 40 % below the cost for the initial EOP Technology.

## PROCESS OPTIMISATION IN THE WOOD COATING SECTOR

Flaviano D'Amico <sup>a</sup>, Maria Velardi <sup>a</sup>, Giulio D'Amico <sup>b</sup>

<sup>a</sup> ENEA CR Casaccia

<sup>b</sup> DEVA Consulting s.r.l.

Experiences of wood coating optimisations occurred in the so-called Chair Triangle, in Italy, are described. The Chair Triangle is a territory, lying in the North East of Italy, in which a great amount of small companies are producing mainly wood chairs. ENEA has carried out, in the last few years, some interventions aimed at improving the environmental quality affected by the chairs production.

In the article interventions aimed at improving the transfer efficiency are described: the results in saving coating agents and in reducing VOC's emissions are important, but not generally sufficient for the VOC's directive compliance. The transfer efficiency increase brings also to a quality improvement.

### INTRODUCTION

Within the period 1999-2002 several tests were carried out in Italy by ENEA for checking the applicability of the directive 99/13/CE, the so-called Solvent Directive.

One of the most interesting case was studied in the Italian industrial district of Manzano, characterized by furniture production, mainly chairs. This district was selected because of its peculiarities, that can be so summarized:

- *the product: chairs present a difficult shape for the finishing process (coating);*
- *the application technique: at present the best applicable technique is spraying;*
- *the market: chair is generally a poor product, and it is generally difficult to invest great amount of money for reducing emissions.*

All these peculiarities cause great amount of VOC's emissions in performing the coating process, and don't allow easy to reduce them.

This paper is aimed at describing the coating process in the Manzano district and the solutions found for reducing the VOC's emissions arising from this process: it is possible to speak of optimisation of the process because the solution found for reducing VOC's emissions present also negative costs and a material consumption reduction.

### THE MANZANO DISTRICT

The district surface covers at least three municipalities, Manzano, S. Giovanni al Natisone, Corno di Rosazze, whose surface form a triangle (The Chair Triangle): since 1980 other productive units can be found in the neighbourhood. The density of productive units is very high, as it pointed out in the table below:

**TABLE 1: Density of productive units**

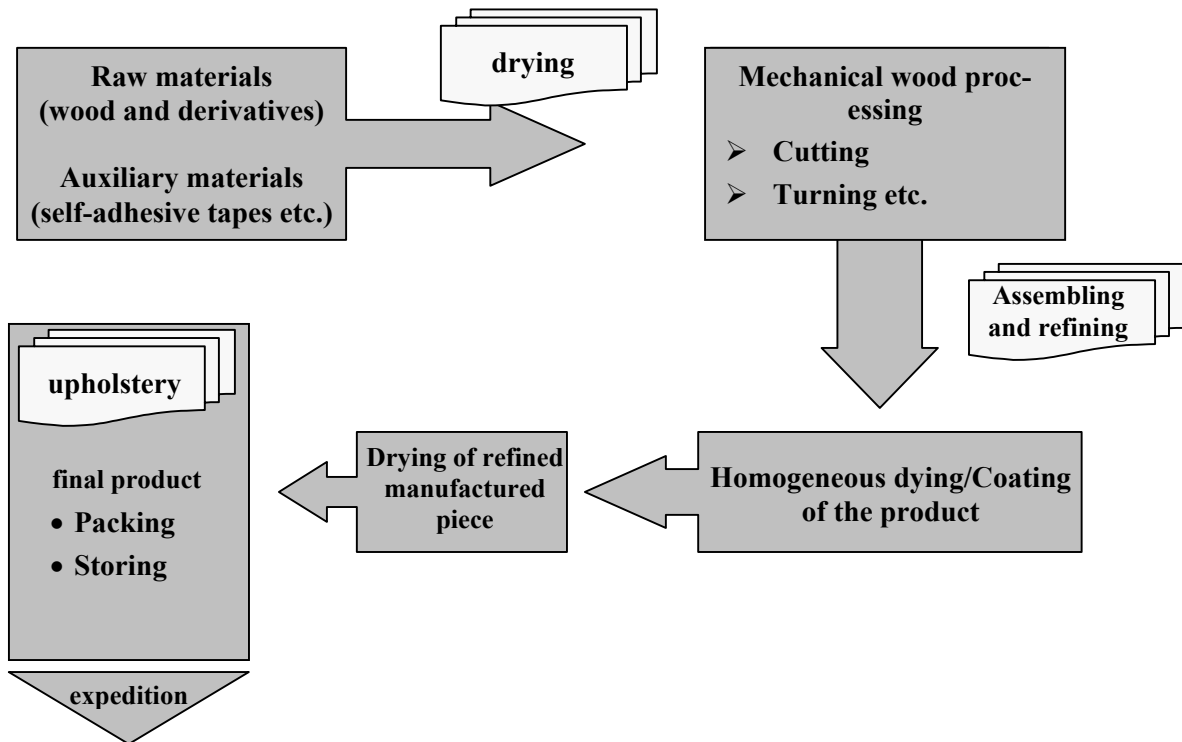
Year	1991	1996	Var. %
Enterprises	955	990	2.0
Employees	10,300	11,121	8.0
Employees/enterprises	10.8	11.2	3.7

*Source:* R. Grandinetti, *Il seggiolaio e l'economia globale*, CEDAM, Padova, 1999

It is evident the small size of the enterprises.

The peculiarity of the ENEA intervention in the district was the trial of applying the solvent Directive without using “end of pipe” solutions, given the size of the enterprises and their economic strength.

Attention was paid to the production cycle, and mainly to the coating cycle, responsible of almost all VOC's emissions.

**FIGURE 1: The scheme of the chairs production cycle**

### THE COATING CYCLE AND THE COATING PRODUCTS

Generally, the most diffused coating cycle, in the district, can be so schematised:

- a first step in which the wood colour is homogenized by applying a thin layer of a dyeing solution;
- after drying, a second step in which the first paint application is performed;
- a third step consisting in putting off mechanically the excess paint;
- a fourth step in which the second paint application is performed;

Sometimes it is possible to find variations, because the paint application is performed in three steps, sometimes there is a primer application after the dying homogenisation, but the described coating cycle can be considered the typical cycle of the district.

In the table below, the 1999 consumption of the coating agents, in the district, is pointed out:

**TABLE 2: Coating agents consumption in the district**

Coating Agent	Number of installations using the coating agent	Total quantities of coating products used in 1999 (kg)
Polyurethanes	102	3,406,269.13
Acrylic	33	143,184.50
Polyesters	4	11,619.80
UV Cured	4	37,335
Water born	5	17,145
Nitro	11	17,800
Ureic	11	62,643
Alchydric	2	423
Total	110	3,696,418.93

In table three the 1999 consumption (in kg) of the dying solution is pointed out:

**TABLE 3: Dying solutions consumption in 1999 and relative emissions (kg)**

Water born solutions	VOC's emissions by Water born solutions	Solvent solutions	VOC's emissions by Solvent solutions
52,5947	52,595	212,277	201,663

Analysing the coating products and the dying solutions it is evident that the substitution of the products in most cases already occurred. Nitro products have been substituted by polyurethanes, while, when possible, water born product have been introduced.

Producing chairs, the shape of the product is limiting the applicable technical solutions: the use of water born products can be performed only changing radically the coating cycle and needs additional production steps in performing the cycle: in the district the water born products are used only in some cases, coating flat surfaces, and it is not possible at present to extend their use because of the final costs of the chairs that would not allow the marketing of the product.

The substitution occurred also in the dying solutions, that emit more than the coating agents: a dying solvent solution emit 95% of its own weight, nevertheless if all dying solutions were water born, the district had reduced 180 tons VOC emissions. That is nothing compared to the total emission caused by the district, that can be estimated at least in 20,000 tons per year.

Other small contribution in reducing emissions could be achieved caring the dilution of the paint products before their application: it has been found that the optimal dilution quantity for the district lies between 20 and 30% of the paint quantity. In some cases diluents additions of 50% have been found, and in other cases wrong diluents additions together with the inexistence diluents management let the diluents consumptions achieve the 65% of the coating consumption. These cases, where pointed out, turned in some months to normal diluents consumptions, saving 600-700 tons of diluents. In this case it was achieved an environmental improvement saving materials, but the extent was to limited for considering achieved the aim of the intervention.

Considering the difficulties in substituting polyurethanes with water born paints, the only primary measure for complying with the solvent directive, the ENEA team active in the district begun to consider the waste caused during the paint application.

The shape of the product, so "three-dimensional", full of empty spaces, determines the ways in which coating products can be applied. In the district, spraying is the most diffused application technique. At present spraying is also the more convenient application technique for the district's companies. It is known that spraying is characterized by high wastes, resulting from the so called "overspray", that is the quantity of the sprayed coating agent that cannot be found on the coated surface and that it is found as sludge if water is the mean used to collect this overspray, as generally done in the district. The quantity of the overspray is indirectly expressed by the concept of the Transfer Efficiency (TE).

### THE TRANSFER EFFICIENCY

In the case of this district the transfer efficiency can be expressed as the ratio between the coating agent quantity laying on the substrate (Q1) after drying and the quantity of the coating agent sprayed by the application equipment (Q2). It is expressed in percentage, like the following mathematical formulation:

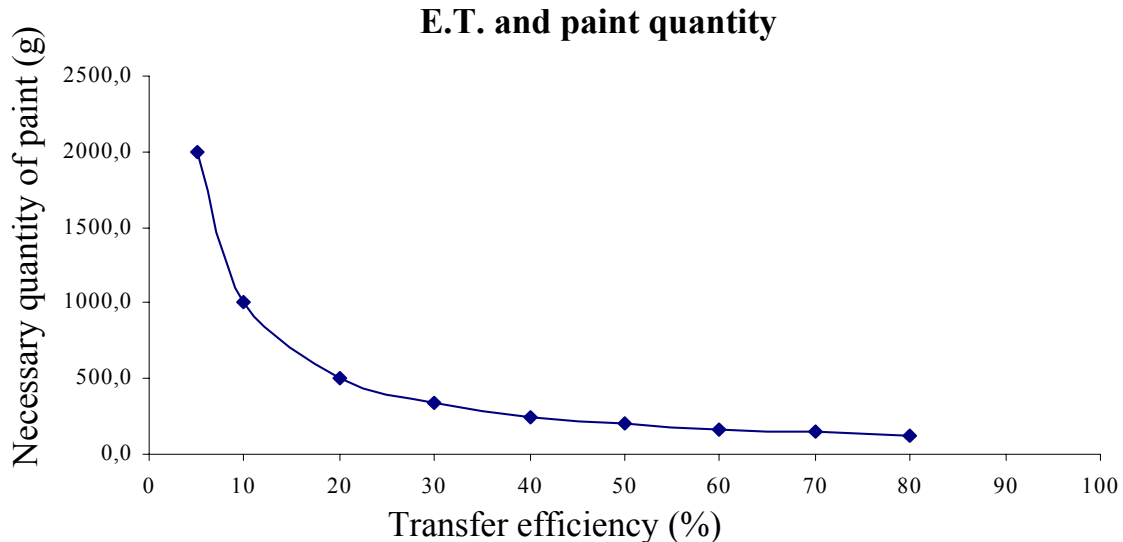
$$\text{Eq1} \quad \text{TE (\%)} = 100 \times Q1/Q2$$

It is evident the importance of a favourable TE in reducing emissions, as pointed out in Figure 2.

In the figure, on the vertical axis there is the quantity of coating to use for applying on the substrate 100g of solid content, while on the horizontal axis the corresponding TE is shown.

If for instance the TE value equals 50%, a 200 g of coating product is necessary for applying 100 g of coating product: an improvement of only 10% in TE reduce the applied quantity to 166 g, with an improvement of 17% in terms of materials and an improvement of 34% in terms of emissions. The curve of figure 2 is a theoretical curve based on the equation 1.





**FIGURE 2: Quantity of coating product necessary for applying 100 g of resin on a surface for different transfer efficiencies**

It is evident that a great emission reduction can be the consequence of small improvement in the TE. The ENEA team studied the problem of transfer efficiency especially in terms of used application equipments, available technical solutions and critical analysis of common concepts.

Generally, in the district electrostatic sprayguns are used. It allows to transfer better the coating agent to the chairs, because of the electric field between the gun and a metallic support, generally one of the hook transporting the chair during the coating application and drying phases. The particles of paint are micronised and then transferred to the surface to coat: in the case of electrostatic spraygun the particles' trajectory is not linear, but it is deceiving the support, improving, at least in theory, the transfer efficiency and saving materials.

The kind of spraygun used are HVLP (high volume low pressure) because it is known that they show the best transfer efficiency. So there is an optimal situation given by the use of the most efficient spraygun in the most efficient situation (use of the electrostatic systems).

This is stated also by the application equipments producers that declare for the HVLP application equipment a TE between 65 and 75%. The same values are accepted from the Italian local authorities in authorizing the installations: in some cases the authorization prescribes the use of HPLV application equipments.

Measuring the TE in the installations, the resulting values are not congruent with the producers statements, not so different from other kinds of application equipments, like airspray, airless, airmix equipments. All these equipments have, like HPLV, lower TE than declared by the producers.

## THE COATING LINE TRANSFER EFFICIENCY

The ENEA team analysed the TE in three installations, obtaining the following results:

**TABLE 4: Experimental TE found in the analysed installations**

Installation	Application system	Average value of TE
Installation 1	Electrostatic spraying by anthropomorphic robot	38.8 %
Installation 2	Electrostatic spraying by anthropomorphic robot	47.7 %
Installation 3	Manual spraying electrostatic application	21.3%

The coating products were the same in the three cases. These results don't mean a difference in the efficiency of the three installations, because it is not possible to apply the concept of TE, developed for lab determinations, to the line efficiency.

The TE declared by the equipment producers is determined in normalized conditions; the panel to coat is flat, the gun-panel distance is determined and fixed, etc. The TE achieved results, in these conditions, are not representative of the results achieved at the production line, with variable climatic conditions. The shape of the products, the line speed, the desired quality can influence greatly the TE results determined at the production line. It is necessary, to avoid ambiguities, to introduce another concept, the coating Line TE, or to specify, in case of production determination, the product to coat, the line speed, the paint viscosity etc. Anyway, it is not correct to refer to production lines with the TE declared by the producers.

From a practical point of view, the experimental TE results obtained mean that peculiarities other than the application equipments have to be used in order to reduce the emissions.

Analysing the factors controlling the TE, two factors were investigated: the frequency of the housekeeping, and the surface humidity of the product to coat.

The first factor can be important, because the hook carrying the chair represents one pole of the electric field used for optimising the coating: generally the hook housekeeping is made every week, and experiences have been carried out for investigating the difference in the applied paint in case of daily housekeeping. The results are in the following table:

**TABLE 5: Experimental coating results obtained varying the housekeeping frequency**

<i>LOW Frequency Housekeeping</i>		
Leg weight (g)	Coated leg weight (g)	Applied paint (g)
618.0	623.7	5.7
550.1	555.0	4.9
575.3	580.3	5.0
583.0	588.5	5.5
574.2	579.2	5.0
	Average	5.22
	Standard deviation	0.36
<i>Daily frequency housekeeping</i>		
Leg weight (g)	Coated leg weight (g)	Applied paint (g)
611.5	617.1	5.6
588.4	594.4	6.0
650.1	655.8	5.7
542.2	547.9	5.7
583.7	589.2	5.5
	Average	5.70
	Standard deviation	0.19

Other investigations have been carried out considering the influence of the relative humidity on the effective TE. Two samples of 10 elements, conditioned at different relative humidity, (35% and 65%) have been coated in the same day, on the same production line. The results are shown in the table below: it is evident, considering the quantity of sprayed and applied paint (considered as solid content), that there is a great increase in the experimental TE, almost 51%.

Several entrepreneurs have taken into account these results for improving their processes. In average, a solvent saving up to 35% has been achieved, together with an emission reduction up to 44 %. Only this intervention was not sufficient, in some cases, for complying with the directive. In other cases, the target emissions was achieved.

A very important result is pointed out in Table 5; considering the value of the standard deviation got in the two samples, it is evident that the housekeeping improvement allow also an improvement in the quality of the product.

**TABLE 6: Experimental results obtained varying the chair relative humidity**

	Elements conditioned 65% relative humidity	Elements conditioned 35% relative humidity
Surface Umidity	14.5 %	8.1 %
Paint solid content	35.1 %	35.1 %
Average quantity of the paint on the surfaces (S.C.)	9.4 g	6.2 g
Average quantity of the paint sprayed (S.C.)	12.3 g	12.3 g
<b>Experimental Transfer Efficiency</b>	<b>76.2 %</b>	<b>50.6 %</b>

## CONCLUSIONS

In the so-called Italian Chair district, in which a meaningful quantity of chairs every year is processed, it has been performed an intervention aimed at reducing VOC's emissions arising from the wood coating process. Peculiarity of the intervention has been the choice of reducing emissions by process optimisation. The increase in the Transfer Efficiency, the ratio between the sprayed quantity of paint and the applied

quantity of paint, has been the selected mean for optimising the process. It is necessary to take care in using the concept of Transfer Efficiency because the value generally considered are not determined on the production lines, but in normalized lab test. The TE value generally accepted refer to the equipment itself, and are not linked to operating conditions.

The determination of the experimental TE has evidenced, in terms of optimisation and environmental topics, the uselessness of the TE generally accepted, referring to lab tests.

In the district the way for reducing emissions and optimising the process has been found investigating the parameters influencing the experimental TE, like the surface humidity of the products to coat and the housekeeping improvement. Combining the two parameters in some installations an increase of the experimental TE has been achieved, up to 20%. In other terms it has allowed, in average, to reduce emissions up to 44%, and to save a third of the solvent consumption.

The process optimisation results also by the achieved quality improvement.

In this paper it is shown how the TE concept is frequently wrongly understood. It seems that not the use of the application equipment, but the choice of the best application conditions is very important in achieving the optimisation target. It is an important issue that could have important economic consequences. Future investigations could analyse the experimental TE resulting from the use of good application conditions and other application equipments.

## REFERENCES

- F. D'Amico, F. Bulian, A. Speranza, M. Tiberio. *Distretto della Sedia. Gli aspetti ambientali e le migliori tecnologie*. Vol.1 e Vol. 2. CATAS Dicembre 2002
- D'Amico F. 2001. *Cenni di teoria e pratica delle BAT*. Pages 13-61 in
- F. D'Amico (ed.) *Territorio e ambiente. L'uso delle BAT per il miglioramento dell'efficienza ambientale del sistema industriale italiano. L'aggregato progettuale CO.ME.T.A*, Round table ENEA, Roma.

## **MODELING AND SIMULATION IN THE SECTOR OF NATURAL STONES FOR IMPROVING THE INTERNATIONAL COMPETITION**

**Stefano Sietta, Lorenzo Tiaci**  
Università di Perugia, Italy

An effort to implement a decision supporting tool for the activity planning in the supply chain of natural stones considering an international point of view is shown. Decision supporting tool is based on first phase of Modelling the processes from raw materials extraction up to the final products including actual trends in the sector such as the high degree of globalisation in the supply chain. The following phase is to use the modelling for simulate different scenarios and use results for a basis for evaluation. This tool should support the definition of strategies in the sector. Proposed paper is a result of a project supported by ICE an Italian government agency for promoting the international trade of Italian companies, within the GIPIETRE Project. In the paper a model for part of the production process is drawn in order to quantify some cost/benefits of decisions by taking into account dynamic performances in the systems. Aspects concerning the production systems such as environmental or safety aspects, since they are very important in the natural stone sectors could be addressed in following phases.

### **INTRODUCTION**

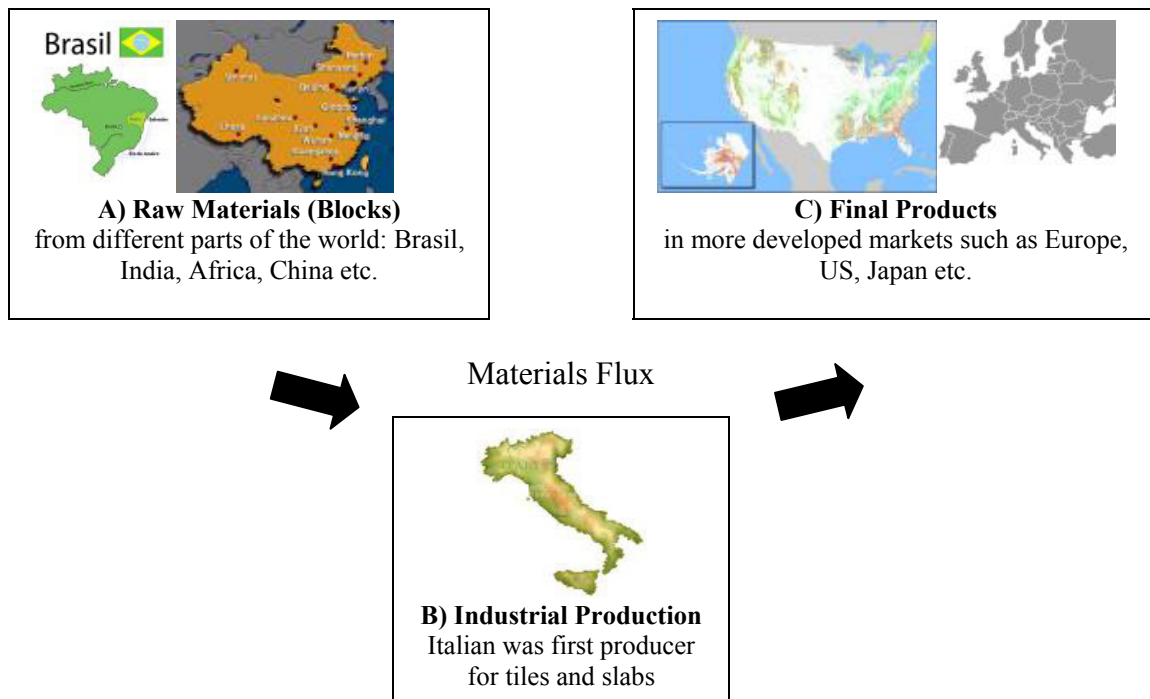
The idea of the paper is to implement a decision supporting tool for the activity planning in the supply chain considering an international point of view. Particular references will be made to the sector of natural stones products. The decision supporting tool is based on Modelling the processes from raw material extraction up to final product. In the modelling process the present situation in the sector, with an high degree of globalisation in the production is considered. The following phase is to use modelling for simulate different scenarios and use results for a basis for the evaluation. This tool should support the definition of strategies in the sector.

Proposed paper is a result of a project supported by ICE a government agency for promoting the international trade of Italian companies, within the GIPIETRE Project.

Final industrial products in this sector are tiles and slabs. Tiles, 30% of the market are usually used as building materials for interior or exterior coverings. Slabs are sold to small producers for making a very customised production: mainly cemetery buildings but also decorative, bathrooms fountains and every thing can be done by natural stones. From the consumer point of view slabs are in effect are and intermediate product.

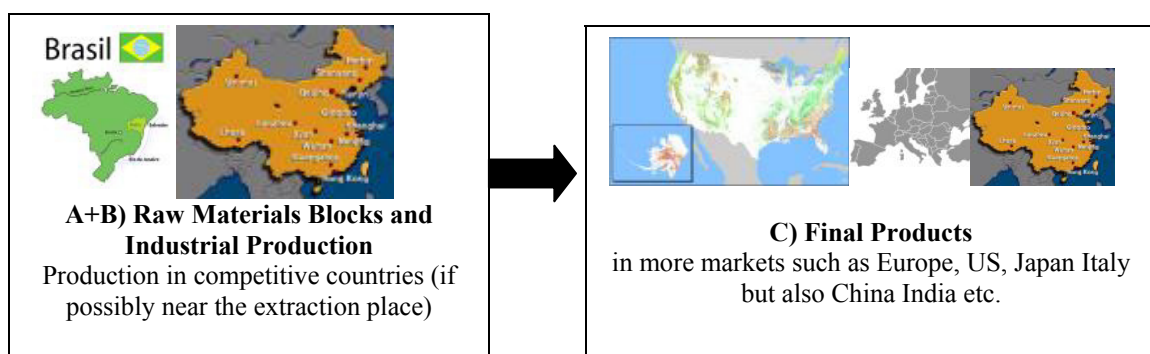
In the present scenario Italian companies, mainly Small and Medium Enterprises in order to face a global and competitive market are looking for new international strategies by using all the business opportunities world wide. This operation, while compulsory, is very critical because there are many aspects to consider in the internationalisation process, concerning know how lost, innovation procedures and thinking a new role for the Made in Italy.

In the paper an effort in this direction is made referring in particular to Italian SMEs operating in the sector of natural stones. In this industrial sector Italy was the leader since few years ago. Italian stones were exported world wide. All kinds of marbles and granites, from every where in the world, were worked in Italian companies and then sold abroad towards essentially more developed countries. In FIGURE 1 past situation is depicted.



**FIGURE 1: Natural Stones supply chain: past situation**

Now the scenario is changed and Italian companies can not focus their business only on the production phase, but to all the supply chain. The promotion of particular materials, new marketing solutions and an internationalised production system are the only way to survive. Now first producer is China and others countries such as India or Spain are growing much faster than Italy. Regarding the market, this is worldwide since the last twenty years. Buyers of a particular kind of marble or granite can be, in fact, spread out every where in the world. In FIGURE 2 effective trends are shown.



**FIGURE 2: Natural Stones supply chain: present trend**

Modelling and Simulating the Supply chain of natural stones is a first step for studies aimed in improving the production systems.

In the paper a model for part of the production process will be developed in order to quantify some cost/benefits of decisions by taking into account dynamic systems performances and criticalities.

Other aspects concerning the production systems such as environmental or security aspects, even if very important in the natural stone sectors, are not specifically addressed in this phase. In the future, in a more worldwide market, where there will be much more consumers than now, the problem of depletion of natural resources such as particular stones or marbles could be an issue.

In the decision process anyway, decision support tools considered should take into account all aspects and especially aspects more connected to the strategic plan level.

Also considering the development of just in time production systems, tools for the management of the whole supply chain will have a strategic role in the future competition. In the following a brief description of the GIPIETRE project will follow and afterwards some aspects of modelling the process representing the supply chain will be shown. Afterwards analysis of possible development will be considered a first consideration in the evaluation will be discussed.

### **GIPIETRE PROJECT**

GIPIETRE is the Italian acronym of new international management strategy in the supply chain of natural stones and is a project funded by Italian government by ICE, the national agency for the International trading development. GIPIETRE goal is to analyse and search for new ways of management of the supply chain in the case of small and medium enterprises improving performances in this high competitive sector. In particular in the project there is an international cooperation an Italian enterprise, an Italian University, a company in Brazil and a company in China. The role of the Industrial Engineering Department, in particular will be the ability to offer, by means of its competencies in the sector of industrial plants, evaluating methods supporting decisions on how to manage the production and consequently the logistic of operations from the raw materials to the final products in the different markets.

How to outsource the production in countries such as in China and Brazil in the manner to contribute actively to the Italian technology transfer in that countries while increasing the competencies in other strategic activities is one of the aims of GIPIETRE. Today companies for surviving have continuously to improve their offers with a greater production gamma, they must manage a worldwide marketing network and guarantee maximum quality while continuously keeping lower costs. Internationalisation became a compulsory solution for keeping working in the market.

### **MODELLING THE SUPPLY CHAIN**

As stated in the introduction, the supply chain of the natural stones is a high competitive sector. In fact this production is facing an increasing number of new competitors from fast developing countries.

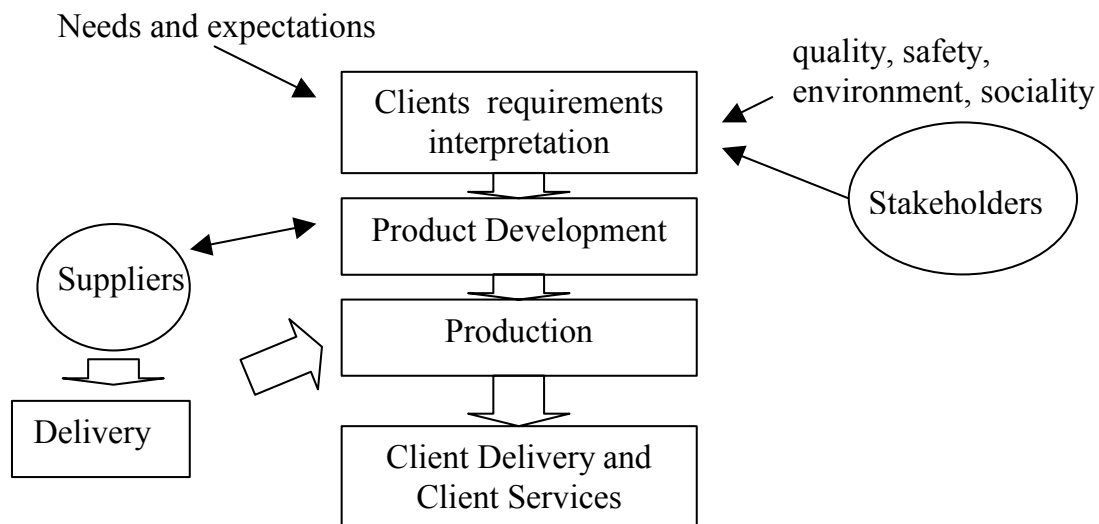
In order to keep the competition level all the supply chain from the beginning raw materials to the selling of final products, passing by auxiliary materials and scraps, must be considered in the decision process in order to be able to search for and control the competitive factors.

Specially in the sector of natural stones industrial production there is a lack of reference modelling and also test case application. This is because it is a relatively small industrial sector for dimension, respect to other sectors such as steel industry or car industry and also because main producers are not located in most developed countries. At the present in Europe main producers are Italy and Spain while worldwide China is becoming the first producer and other countries such as India, Brazil, Egypt are growing very fast.

Other models developed for general production purpose could be adapted and extended to the case of natural stone sectors in order to face the demand response, replenishment needs, lead times and costs, continuous changing in a global market, e.g. (Boctor et al., 2004) (Khouja et al., 2005) (Heragury et al., 2005). The point is that this process is becoming the more and more complex since many production systems, even if they are controlled by medium and small companies, tend to be spread out all over the world in a production network. Usually there is no much material about real cases, because the application can be too cumbersome and it could seem not too much meaningful respect to well tested references cases. In order to facilitate the application to real case there are also methodologies aimed in speeding up the modelling and also the simulation process such as lean simulation (Bruzzone and Saetta, 2002).

In any case the first phase in the modelling of complex industrial activities must take into account all the process and also consider strategies aspects. Strategies can help developers in fixing the goals of modelling, the first phase in each modelling activities.

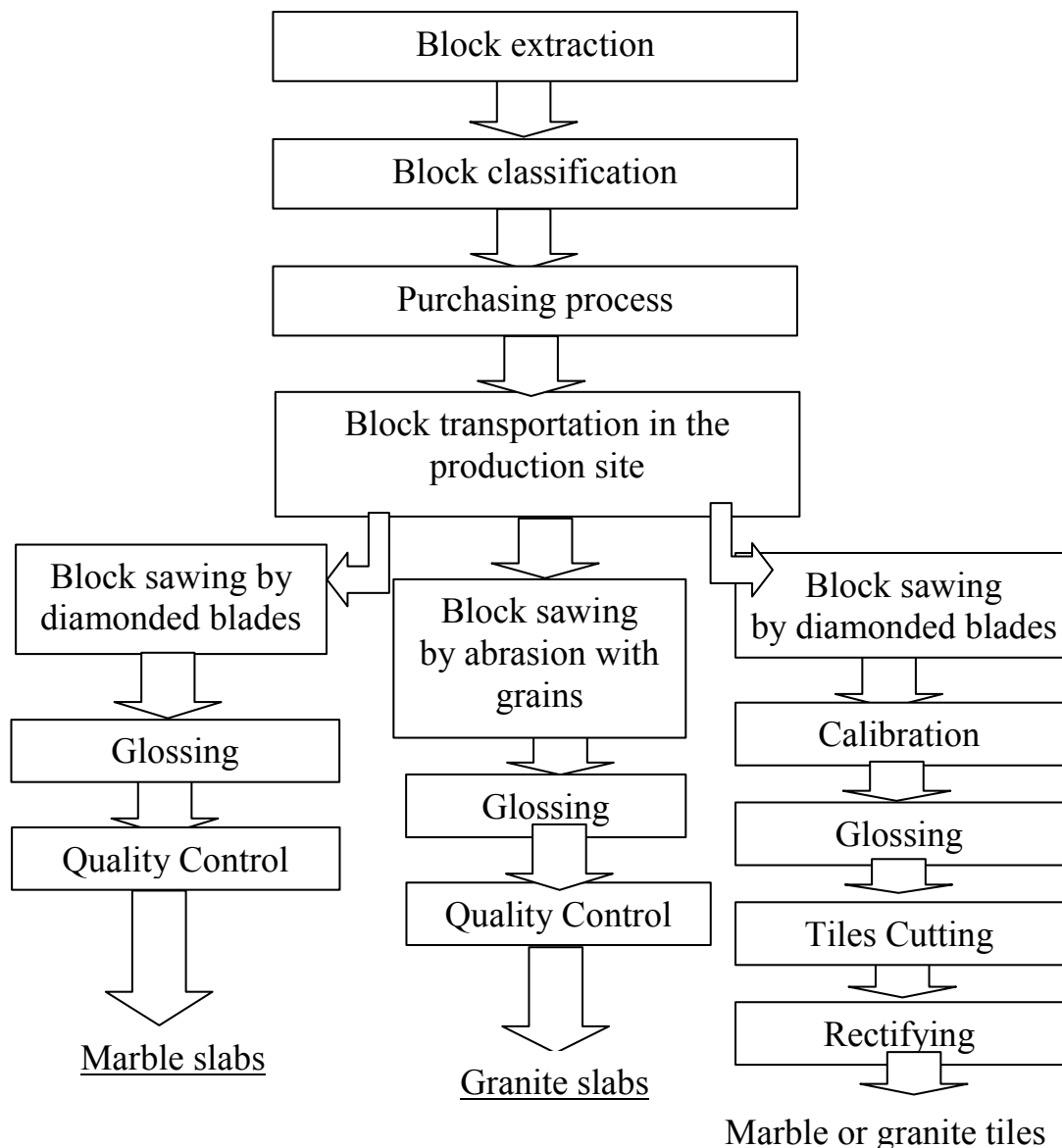
In the following the attention will be focused on the process modelling phases. In FIGURE 3 all mainly activity in the process are considered at a macro level.



**FIGURE 3: A general process for production systems**

In the figure some of more important aspects are considered such as client satisfaction, concurrent engineering, logistics issues. Today all this aspects must be faced in world wide way. Phases can be located in different places. When thinking to an old sector the process considered in FIGURE 3 should be compared to some consolidated practises in the sector. In FIGURE 4 production phases are shown.





**FIGURE 4: Production phases as today from (Saetta and Tiacci, 2005)**


In order to consider all strategies at least in the long time all processes considered in FIGURE 4 should be considered to change in order to improve the whole process in FIGURE 3. This is a quite hard task considering that production phases are the results of process started years ago, even if could be the most effective way to try in order to include in the competition also new factors that should be not only production costs. Looking for more customer oriented, just in time solution could be allow the integration of traditional production systems. At the present solutions should be towards a very delocalised systems where at least production phases should be localised nearby

## RESULTS AND FUTURE DEVELOPMENT

In the present paper current trends in the supply chain of natural stones were discussed. Present research efforts are shown concerning findings new strategies for increasing competitiveness especially referring to Italy, by describing the GIPIETRE projects. First results of the modelling of the supply chain pointed out that before the optimisation of single phases a focal point is to re-thinking about all the process in order to

find new possible dimensions of competition for increasing and improving competitiveness including important issue such as qualities, customer satisfaction and environment. In future research it would be interesting the development of new solutions considering different practises respect to the present and to evaluate the feasibility in a world wide environment.

#### ACKNOWLEDGMENTS

The research activities of the present paper has been supported by  ICE – Istituto del Commercio Estero , the institution of the Italian Minister of Production activities, within the project GIPIETRE and within the agreement with CRUI, the permanent conferences of Italian Universities Chancellors.

#### REFERENCES

- F.F. Boctor, G. Laporte, J. Renaud, 2004, “Models and algorithms for the dynamic-demand joint replenishment problem”, *int. j. prod. res.*, 01 July 2004, Vol. 42, No. 13, 2667–2678
- F. Bradley, 2004, *InfoMARBLE*, Promorama Editions, Vol 1,2
- F. Bradley, 2004, *MarmoStat*, Promorama Editions
- A. Bruzzone, S. Saetta, 2002, “LESNEX: Lean Simulation Network of Excellence”, Proceedings of HMS 2002, Bergeggi (SV) October 3-5, pp. 179-186.
- M. Khouja, S. Park and C. Saydam, 2005, “Joint replenishment problem under continuous unit cost change”, *int. j. prod. res.*, 15 January 2005 , Vol. 43, No. 2, 311–326.
- S. S. Heraguy, L. Duy, R. J. Mantelz and P. C. Schuurz, 2005, *int. j. prod. res.*, “Mathematical model for warehouse design and product allocation”, 15 January 2005, Vol. 43, No. 2, 327–338.
- C. Montani, “*Stone 2004*”, 2004, Gruppo Editoriale Faenza Edition, Faenza (RA), Italy.
- S. Saetta, L. Tiacci, 2005, “Lean Simulation as a tool for the management of supply chain in the sector of natural stones”, Proceedings of SCSC 2005, Philadelphia, US July 24-28.

# **GLOBALISATION OF TECHNOLOGY: LESSONS FROM THE EAST ASIAN EXPERIENCE FOR OTHER DEVELOPING COUNTRIES LIKE IRAN**

**Reza Salami**

University of Allameh, Tehran, Iran

**It is argued that the globalisation of technology has a very important role in the success of any nation in the international market. The experiences of many East Asian Newly Industrialized Countries (NICs) indicated that the acquisition, adaptation and absorption of technical know-how along with strengthening of their local technological capabilities have contributed mostly to their rapid economic and industrial growth. Having recognized the importance of management of global technology transfer, many Less Developed Countries (LDCs) have not designed appropriate strategies and policies for technology transfer and development. Therefore, the policy makers of these countries should adopt and design suitable strategies for this purpose. One of the main objective of this paper is to investigate global management of technological innovation by some successful East Asian NICs. This is mostly due to the fact that the other LDCs can draw valuable lessons from them. Firstly, the most critical success factors of East Asian NICs are discussed. Some invaluable lessons derived from their experience for other LDCs like Iran, will be proposed.**

## **INTRODUCTION**

The importance of the East Asian NICs can be attributed to their key role as the major world centre of international market and trade. The diversity of these countries in some overall economic indicators such as per capita income, natural resources and the process of their industrialisation, can be helpful for other developing countries with similar characteristics to pursue their technology development strategies. These countries could increase their productivity level as well as managerial and technological expertise by adopting appropriate macro policies for technology transfer and industrialization. They can also manage successfully to decrease their technological gap with the more technologically advanced countries through a catching up process. Although there are some differences in the stage of development, size of economy, resource endowment etc, the industrial and technological development experience of these countries has been of interest to most Less Developed Countries (LDCs), in particular those which attempt to promote their technological capability through the same pattern of rapid industrialization. Moreover, the analysis of the industrialization experience of East Asian NICs may assist the policy makers in other LDCs in an understanding of the development process. The success of the East Asian countries, as (Krugman, 1994) noted, shows that there has been a major diffusion of world technology in progress, and western nations are losing their traditional advantage. Therefore, the experience of successful East Asian countries in industrial and technological development can have valuable lessons for the other developing countries in the other parts of the world. These countries could increase their technological capability and managerial expertise by adopting appropriate industrial and technological development policies and strategies. However, many Less Developed Countries have not designed appropriate strategies and policies for their technological development yet. Therefore, the policy makers of these countries should adopt and design suitable strategies for this purpose. Iran, as a Less Developed Country, has also attempted to find the best approach to technology development in order to improve and promote its technological capabilities and industrial and economic development.

## SUCCESS FACTORS FOR TECHNOLOGY GLOBALISATION OF EAST ASIAN NICs

Having surveyed the success factors of technological globalisation in East Asian NICs, it is widely recognized that the core of success in East Asia has been a set of appropriate and interrelated policies. These were mainly focused on macroeconomic stability, human resource development, industrial and technological capability expansion and outward looking, strong export promotion, or what can be said as their overall technology globalisation policy. Neo-classicals' view about the success of East Asian NICs confirms the fact that it was a package of policy measures in these countries and mainly adopting market-friendly mechanism towards acquisition of foreign investment and technology as well as heavy investment on human capitals that contributing more in their success (Booth, A. 1995; Krugman, P. 1994; Petri, P.A. 1995).

The World Bank study (1993) indicates that the most important reason behind the East Asian success story can be the adoption of effective policy measures including outward looking strategy, designing specific programs for developing indigenous technological capability as well as their massive importation of technology, and expansion of a well-skilled and qualified workforce (World Bank, 1993).

According to flying geese model, many developing countries can replicate the models of developed countries or other successful countries with relatively similar characteristics. LDCs can take advantage of being latecomers and therefore they can achieve rapid industrial and technological development through a catching up process (Kojima, K. 2000). As the experiences of some successful Newly Industrialized Countries (NICs) in East Asia indicate, they could reach to a very high degree of development and close their technological gap with developed countries. Therefore, it can be argued that the technological gap between LDCs and developed countries can accelerate the process of catching up technologically between these two groups of countries through adoption of an effective technology globalisation policy based on the acquisition and adaptation of foreign technology, as well as promotion the indigenous technological capability. The Flying Geese pattern of technological globalisation is transmitted from a lead goose (Japan) to follower geese (Newly Industrializing Countries (NICs), ASEAN 4, China, etc.)

These countries adopted an appropriate technology globalisation policy concentrating on the development of their indigenous technological capability through efficient R&D activities as well as acquisition of new and modern technologies in order to promote the level of competitiveness and productivity of their products in the international market. As Forbes and Wield (2000) stated "many firms in these countries (East Asian NICs) have chosen to build innovative capacity, both incremental and process and design and product. As firms try to add more value to their activity, product innovation becomes increasingly key, and the role of R&D includes building independent design capacity for the firm" (N.Forbes and D.Wield, 2000).

The effective implementation of technological globalisation strategies have also been followed by efficient and large investment in their technical human resources which enabled them to strengthen their absorptive capacity of high and modern technologies. Moreover, the government in these countries played a key role in directing and conducting efficiently these policies by providing adequate infrastructure and facilities. The close co-operation between private enterprise and the government has also been a central element in the success of these countries.

### **LESSONS TO BE LEARNED FOR OTHER LDCS SUCH AS IRAN**

Having analysed the key success factors of technological globalisation in East Asian NICs, one can draw some general lessons and recommendations for the other LDCs which decide to pursue the similar pattern of technological globalisation and development. One of the major lessons that other LDCs can learn from the experiences of these countries is that they have adopted an appropriate and effective technology globalisation strategy which has been supported by some other policy measures including development of human resources and creation of a stable macroeconomic environment. Moreover, the adoption of an aggressive export promotion policy in most of these countries accelerated the flow of foreign investment and technologies in these countries and also the rapid integration of their economy to the world economy. These policies have also been very effectively implemented through the key and flexible role of their governments. Therefore, there is an essential need for every country to design and formulate an appropriate technology globalisation policy based on its overall national development strategy aiming at the development and promotion of indigenous technological capability as well as the adaptation and absorption of imported technology and customising it for local market.

LDCs can take advantage of being latecomers and therefore their growth might be more rapid than those of their predecessors. In other words, LDCs can be more successful through a catching up process that does not need to reinvent the wheel. Therefore, it can be generally said that other LDCs may also achieve similar and even better results if they pursue the same model and a set of appropriate policies which have previously been experienced by successful countries in particular East Asian first and second-tier NICs.

Iran is a resource-rich country that is located in a strategic area of 1.65 million square kilometres, with the Caspian sea, Turkmenistan, Armenia and Azerbaijan in the north, Turkey and Iraq to the west, the Persian Gulf and the Gulf of Oman in the south and Pakistan and Afghanistan to the East. It has a population of about 70 million people. It is one of the major oil exporting countries in the world and also has substantial gas and mineral reserves including coal, chromium, copper, iron ore, lead, manganese, zinc, and sulphur. Moreover, Iran has a relatively good transportation network, including about 4,850 km of railroads, 140,200 km of highways, more than 14 main ports, 132 ships, and 261 airports (World Factbook, 2005). Iran's Gross National Product (GNP) amounted US \$ 139.6 billion in 2004 and it has grown by an average growth rate of 3.9 percent in 2004 (World Bank, 2005).

The experience of the successful East Asian countries in rapid industrial and technological development can provide valuable lessons for other LDCs including Iran. Improvement in management of technological development capabilities in Iran has been for long time the center of policy concern in Iran. The policy and decision makers in Iranian industrial sectors have been well aware that the key to long-term economic growth and technological progress lies in designing and implementing effective national technology development policy. In other words, the country has been in great need of some effective policy measures to promote indigenous technological capability and stimulate local inventive and innovative activities. In this respect, more emphasis has been placed on the adoption of policies concerning effective cooperation with university and R&D centres and proper technology transfer mechanisms to promote innovation capacities of the country.

It seems essential for Iran as a country that is highly dependent on the oil revenues, to emphasise more on the expansion of non-oil exports through the greater emphasis on the export promotion policy. This is mostly because the country cannot rely

on oil revenues in the long term as the main source of foreign exchange due to declining oil resources and prices. Therefore, the development of a non-oil export sector capable of replacing the oil income is very important for the long-term and overall prosperity of the country. Moreover, as the experience of some successful countries in the implementation of export promotion policies shows, it would be better for Iran to strengthen primarily those industries and areas in which it has already comparative and competitive advantage, such as labour-intensive and resource-based industries as well as some of its traditional handicrafts, such as carpet. In the later stage, it will be necessary to develop some of its high-tech and capital intensive industries. This in turn, would need a larger investment in developing the country's infrastructure including communication system, transportation networks, as well as upgrading the educational indicators and skill-level of the labour force in order to assimilate and absorb the new and modern technologies to the local conditions.

As the experience of the East Asian countries shows, research and development activities have played a very important role in the promotion of indigenous technological capability as well as absorptive capacity for importing advanced technology and therefore it led to their successful technology globalisation in these countries. In order to become competitive in the international market, Iran has to develop further its research and development activities through the allocation of more R&D expenditure as percentage of GNP particularly industrial research. Iran needs to improve and expand its R&D level and activity in order to be able to acquire high and advanced technologies more effectively. Therefore, more investment should be allocated for R&D activities involved in the adaptation and assimilation of foreign technologies rather than on initially adopting them. In addition, measures are necessary to encourage R&D institutes to become strongly involved in supporting local industrial and technological development in order to achieve rapid technological globalisation. It is also necessary to expand the industrial research institutes regarding the needs and skills of local industry, university and the government organisations. Furthermore, special attempts are needed to coordinate the research activities of industrial firms, public institutions and research centres and universities. It seems also essential to encourage private industrial firms to allocate more investment in the R&D activities. This can be in the form of allocating a larger percentage of their sale in research and development activities.

The state has also played a very important role in technological globalisation of East Asian NICs by providing the effective and stable macroeconomic environment. The state in these countries can also be characterised as strong, efficient, market friendly, and relatively less interventionist. The government in these countries changed the previous policies very quickly when they found them to be ineffective. The government in Iran, can also effectively be involved in such a features as identification of the country's potential capacities and needs, formulation of appropriate policies for science and technology development and their goals and objectives, recognition of priorities, and designing a set of appropriate policy measures needed for successful industrial and technological development. The government can also play an important role in the rapid transition to an export oriented policy and rapid integration of local economy to the world economy. The role of government during this transition period towards a more outward-oriented economy is to use the country's oil based resources to improve an infrastructure network needed to improve the industrial products capable of competition in international markets. Moreover, the government should also implement appropriate policy measures to train adequate technicians and engineers for a successful absorption of imported technology. As the experiences of East Asian countries indicate, the gov-

ernment in these countries invests in those industries in which the private sector may be reluctant to invest.

### **SUMMARY AND CONCLUSIONS**

Although the experience of successful East Asian NICs cannot be easily replicated, due to some dissimilarities and special circumstances unique to these countries, some very important success factors of these countries, such as an effective and supportive government role, export promotion policy, and human resource development policy as well as their technology globalisation policy, can be extremely useful for other LDCs including Iran that want to pursue the similar path of rapid industrial and technological development. Therefore, it is very important for the policy makers in LDCs like Iran to design effective national technology development policy that can be integrated to their overall development programmes.

It seems necessary to add that although LDCs can learn invaluable lessons from the experiences of successful East Asian NICs, however, the mere replication and imitation of these successful countries' pattern and policies without considering the local conditions and the country's potential capacity and needs might lead to negative results.

### **REFERENCES**

- Booth, A. 1995, Southeast Asian Economic Growth, Can the Momentum be Maintained?, *Southeast Asian Affairs*: 28-47.
- Forbes, N. & Wield, D. 2000, Managing R&D in technology-followers, *Research Policy*, 29: 1095-1109.
- Kojima, K. 2000, The flying geese model of Asian economic development: origin, theoretical extensions, and regional policy implications, *Journal of Asian Economics* 11: 375-401.
- Krugman, P. 1994, The Myth of Asia's Miracle. *Foreign Affairs*, 73 ( 6): 62-78.
- Petri, P.A. 1995, "The Lessons of east Asian Success: A Primer for Transitional Economies" in S.F. Naya & J.L.H.Tan (ed.) *Asian Transitional Economies, Challenges and Prospects for Reform and Transformation*, Institute of Southeast Asian Studies: 26-56.
- World Bank, 1993, East Asian Miracle, Economic Growth and Public Policy, A World Bank Policy Research Report, Oxford University Press.
- World Factbook, 2005.
- World Bank , 2005, Word Development Indicators.





# CLEANER PRODUCTION TECHNIQUES IN THE PERUVIAN MINING SECTOR

Samuel Mongrut <sup>a</sup>, Sonia Valdivia <sup>b</sup>

<sup>a</sup> Universidad del Pacífico Research Center (CIUP) and Department of Accounting  
Universidad del Pacífico

<sup>b</sup> Department of Industrial Engineering, Pontificia Universidad Católica del Perú

The mining sector accounts for more than 50% of the Peruvian total exports and it is the fastest growing industry in Peru where more than 30% of the foreign direct investment has been allocated. Furthermore, it is the more regulated sector in Peru, so it faces, more than ever, pressure from regulators as well as stakeholders. Given this situation, several mining related companies decided to comply with the ISO 14001 standard. In this study one presents findings from ISO 14001 environmental audits performed to 11 mining related companies (4 mining companies and 7 mining sub-contractors dedicated to blasting, exploration and extraction). One finds several deviations related to *operational control* that lead to negative environmental impacts. Unfortunately, the most common response to these deviations was the adoption of end-of-pipe technologies instead of cleaner production techniques. Hence, one also suggests some cleaner production techniques that could be adopted in order to cope with these deviations.

## INTRODUCTION

Peru is currently one of the favourites destinations for mining investment in South America. In fact, the mining industry has experienced a remarkable growth during the last decades. Nowadays, Peru is the second biggest producer in silver; the third biggest producer in copper, zinc and tin; the fourth biggest producer in lead and the sixth biggest producer of gold in the world. Exports from mining account to 55.8 % of total exports and they largely responsible of the positive current account balance for the economy (MEM, 2005). The economic impact of the mining industry in Peru is really meaningful, the mining sector represents 5.8% of the Peruvian Gross Domestic Product (GDP) and it currently generates more than 375,000 jobs (MEM, 2005). The Fraser Study (McMahon, 2005) stated that Peru is in the seventh place according to its 'best practice mining potential index' out of 64 surveyed regions. Hence, mining activity in Peru seems also promising in the future.

Due to its growing activity, the Peruvian mining sector is subject to several laws such as the Environmental Protection Code, the environmental quality standards: maximum levels for contamination (air, water, and noise), the law for closing mines, the law for the treatment of solid waste, the law for environmental liabilities, and so forth.

Given the stricter regulation and the bigger pressure from different stakeholders (specially from potential affected populations in the last two years), several mining firms have decided to implement the ISO 14001 environmental standard (Glave and Kuramoto, 2002). Of course, there are also other reasons that have played an important role in adopting the ISO 14001 certification. For instance, Mongrut and Tong (2004) conducted a survey among 36 firms operating in different economic sectors in Peru that had an ISO 14001 certification as August 2003 or earlier. The seven mining firms that were included in their sample agreed that the most important reasons to adopt an Environmental Management System (EMS) were its accordance to their environmental charter and the potential improvement of their environmental performance. Hence, they seem to have a true concern for the negative environmental impacts of their operations.

At present, 18 (27%) out of 65 existing certified firms according to ISO 14001 are related to the mining or metallurgical sectors (11 are mining or metallurgical companies and 7 are mining subcontractors). It is also important to note that ISO 14001 certification in the Peruvian mining sector is relatively new, so the oldest certification for a mining operating unit was issued in 2001 (CONAM, 2005).

From the technical point of view, many companies still work with old machineries for extraction, transportation and concentration plants. Hence, more efficient use of resources such as water, oil, lubricants or chemical additives can be achieved. Hence, there is plenty of room to apply Cleaner Production (CP) Techniques in order to reach higher efficiency in the consumption of resources and in their management.

CP is the continuous application of an integrated preventive environmental strategy to processes, products and services to increase overall efficiency and reduce risks to human beings and the environment. CP can be applied to the processes used in any industry, to products themselves and to various services provided in society (UNEP, 2001a).

Although, the concept of CP is currently widely known, implementation of CP techniques in the Peruvian mining sector is very scarce. Mining companies have adopted a passive strategy of complying with the current regulation called PAMA (Program to Adequate the Environmental Management of the firm to a good environmental practice). According to this program, mining firms are obligated to mitigate or eliminate their environmental liabilities.

In order to accomplish this task, several mining companies have adopted end-of-pipe technologies instead of CP techniques (Mongrut S. and S. Valdivia, 2005). Hence, the main objective of this study is to identify possible applications of CP techniques, instead of end-of-pipe technologies, given the deviations found in operational controls through ISO 14001 environmental audits. Furthermore, this is the first study where results from ISO 14001 environmental audits to mining related companies in Peru are presented.

The remaining part of the work is divided in five sections. In the next section one introduces the sample of mining related companies that have been audited, while in the third section one explains the methodology and focus of the research. In the fourth section, one discusses the results from environmental audits and in the fifth section one proposes different CP techniques in order to reduce the deviations found. The last section concludes the study.

## **SAMPLE OF MINING RELATED COMPANIES**

According to an official inventory of certified EMS based on ISO 14001 (CONAM, 2005) and to supplementary information handed by Germanischer Lloyd Certification Company in Peru (GLC, 2005), there are 65 certified companies according to ISO 14001. From them, 18 companies are related to mining sector. Specifically, 9 companies are mining units, 2 are metallurgical units and 7 are mining subcontractors. Units that belong to the mining or metallurgical sectors are medium or big ones that are mostly located in the Andean region of the country.

According to the Ministry of Mining, Energy and Oil (MEM), medium size mining units are those whose production is between 150 and 5,000 tons of minerals per day, while big mining units produce more than 5,000 tons of minerals per day. The seven subcontractors are companies with less than 100 employees.

Table 1 shows the 18 certified mining related companies and the sample of 11 companies for this study. As one may see, the 2 metallurgical units have been excluded from the sample in order to deal only with primary mining activities.

**TABLE 1: Sample of mining related companies**

Type of company	Companies	Minerals	Sample
Mining unit	Minera Milpo S.A.A	Au	No
Mining unit	Minera Sipan	Au	No
Mining unit	Orcopampa	Au	Yes
Mining unit	Uchuchaccua	Ag	Yes
Mining unit	Inversiones Mineras del Sur S.A.	Au	Yes
Mining unit	Minera Cerro Verde S.A.A.	Cu	Yes
Mining unit	Minera Barrick Misquichilca S.A.A	Au	No
Mining unit	BHP Billiton Tintaya S.A	Cu	No
Mining unit	Minera El Brocal S.A.A.	Ag, Zn, Pb	No
Mining unit	Consortio Minero Horizonte S.A.	Au	No
Metallurgical	MINSUR S.A. - Planta Fundición	Sn	No
Metallurgical	Cajamarquilla	Cu	No
Subcontractor	Minera Coalme S.R.L.		Yes
Subcontractor	Empresa Especializada Serminas E.I.R.L.		Yes
Subcontractor	Sonda Sur Contratistas Generales S.A.		Yes
Subcontractor	Inversiones Mineras del Centro S.R.L.		Yes
Subcontractor	E.E. Minera Edisa S.A.C.		Yes
Subcontractor	Congemin J.H. S.A.C.		Yes
Subcontractor	J.H. Ingenieros S.A.C.		Yes

One interesting feature from the sample of 7 subcontractors is that they are linked to the same main client, who supported the implementation of the EMS in each one of them (GLC, 2005).

## METHODOLOGY AND SCOPE OF THE RESEARCH

As it was stated, the sample was composed of 11 mining related certified companies. The EMS of the 11 companies was audited according to the ISO 19011 (2002) auditing procedures and deviations from the ISO 14001 (2004) were identified. It is important to note that the use of the ISO 9011 (2002) standard for auditing is required by the ISO 14001 (2004) to perform internal audits and certification processes. For the purposes of this research, only findings that lead to non-conformities were studied.

Although, there are 17 aspects (elements or items) that may be audited according to the ISO 14001 (2004), one decided to detect deviations related only to operational control (item 4.4.6) because it is the element where more deviations were found and where more applications of CP techniques can be suggested in order to prevent negative environmental impacts and to reduce consumption resources<sup>1</sup>.

<sup>1</sup> There are other elements where the application of CP techniques could be also appropriate such as Emergency preparedness and response (4.4.7).

The requirement attached to item 4.4.6 states the following: “the organization shall identify and plan those operations that are associated with the identified significant environmental aspects in a consistent way with its environmental policy, objectives and targets. The organization can work on this by implementing procedure(s) to control situations where their absence could lead to deviation from the environmental policy, objectives and targets, by stipulating the operating criteria in the procedure(s), and by implementing procedures related to the identified significant environmental aspects of goods and services used by the organization and communicating applicable procedures and requirements to suppliers, including contractors”.

Given this requirement, it is important to identify techniques that are able to reduce the negative environmental impacts of the firm. In order to do this in the next section, one starts by identifying deviations in item 4.4.6 using the information collected by the 11 environmental audits.

### DETECTED DEVIATIONS AND FAILURES IN OPERATIONAL CONTROL

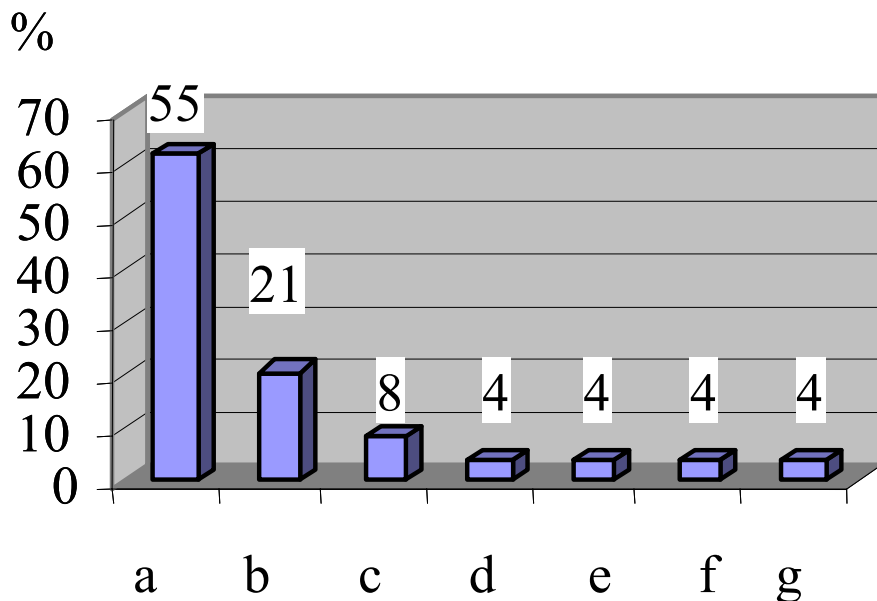
Table 2 shows the number of deviations related to each element (item) required by the ISO 14001 (2004). As one may see, the greater number of deviations is linked to the operational control element. (4.4.6).

**TABLE 2: Number of deviations detected by element of the Standard ISO 14001:2004 per company**

Company	1	2	3	4	5	6	7	8	9	10	11	Total
Element of the Standard												
Environmental policy	-	-	-	-	-	-	-	-	-	-	-	-
4.3.1 Environmental aspects	-	1	-	2	-	-	1	2	-	-	-	6
4.3.2 Legal and other requirements	-	-	-	-	2	-	1	-	-	-	-	3
4.3.3 Objectives, targets and programme(s)	-	-	-	-	1	-	-	-	-	-	-	1
4.4.1 Resources, roles, responsibility	-	-	-	-	-	-	1	1	-	-	-	2
4.4.2 Competence, training and awareness	-	-	-	-	1	-	4	3	2	2	3	15
4.4.3 Communication	-	-	2	-	-	-	-	-	-	-	-	2
4.4.4 Documentation	-	-	-	-	-	-	-	-	-	-	-	-
4.4.5 Control of documents	-	-	-	-	1	1	4	3	1	-	-	10
4.4.6 OPERATIONAL CONTROL	1	1	4	-	5	3	2	2	-	-	-	18
4.4.7 Emergency preparedness and response	1	1	-	2	4	4	1	-	-	4	-	17
4.5.1 Monitoring and measurement	-	-	-	-	-	5	3	-	5	-	1	14
4.5.2 Evaluation of compliance	1	-	2	-	2	-	-	-	-	-	2	7
4.5.3 Nonconformity and preventive action	-	-	-	-	1	2	-	1	3	1	2	10
4.5.4 Control of records	-	-	-	-	3	-	-	1	2	1	-	7
4.5.5 Internal audit	-	-	-	-	1	1	1	1	-	-	-	4
4.6 Management review	-	-	-	-	1	1	1	-	-	-	-	3

Other important deviations were associated to the elements emergency preparedness and response (4.4.7), monitoring and measurement (4.5.1), control of documents (4.4.5), and nonconformity, corrective and preventive action (4.5.3). However, most of

the applications of CP techniques can be suggested in relation to element 4.4.6. The main deviations related to the element 4.4.6 are depicted in Figure 1.



**FIGURE 1: Types of deviations for “operational control”**

Where:

- a) 55% of the deviations are related to inadequate management of solid waste (i.e.: wrong classification of hazardous and non-hazardous disposal of recycle bare rests)
- b) 21% of the deviations can be traced to non-efficient consumption of electricity (at offices in the fields)
- c) 8% of the deviations are related to non-efficient consumption of water (over consumption, leakages or filtrations in the tailings)
- d) 4% of the deviations are due to non-efficient consumption of fuel for transportation
- e) 4% of the deviations are due to spillages of oil
- f) 4% of the deviations are due to emissions of dust when transporting mineral
- g) 4% of deviations are related to wastewaters without treatment

Further relevant findings related to other elements of the ISO 14001 (2004) were the following:

1. Contingency plans for detected risks do not exist or were not implemented or tested (element 4.4.7)
2. Workers or employees were not adequately trained, training needs were no identified or training plans do not include all relevant areas (element 4.4.2)
3. Relevant environmental aspects (such as water consumption, energy consumption, waste generation, etc.) were not monitored (element 4.5.1).

Although these aspects are important, one shall concentrate in the aforementioned deviations related to element 4.4.6. In order to reduce these deviations it is important to apply CP techniques that one discusses in the next section.

## CLEANER PRODUCTION TECHNIQUES IN OPERATIONAL CONTROL

According to guidelines established by the Cleaner Production area of the Production and Consumption Branch of UNEP (UNEP, 2001b), the following alternatives can be considered as cleaner production techniques:

CPT1: on-site reuse and recycling

CPT2: good operating practices

CPT3: technological change

CPT4: change in raw materials

CPT5: product changes

When discussing the potential to implement “change in raw materials” (CPT4) and “product changes” (CPT5) as cleaner production techniques, one must realize that “concentrated minerals or gained metals” are considered final products in the extractive mining industry. As part of a product chain these minerals and metals are delivered to next processes. The only possibility to undertake a preventive strategy is by increasing the level of concentration of metals in the input mineral, in other words, working in richer areas with higher degrees of metal. In what follows, one discusses the application of CPT to reduce the identified deviations in operation control.

- a. In order to solve inadequate management of solid wastes one may apply CPT 1 related to the on-site reuse and recycling strategies. Specifically, one may accomplish the following tasks:

Task 1: *Analysis and quantification of the wastes stream* (origin and destination). In this respect, firms and the Ministry of Energy in Peru do not have a policy of storing and quantification.

Task 2: *Classification of generated wastes.* One may classify generated waste in four (4) groups: hazardous ones/non recycle bare ones (i.e. oils with PCB, rests of explosives, used cans and packaging materials), hazardous ones/recycle bare ones (i.e. used oil), non hazardous/non recycle bare ones (i.e. old tires, rests of ceramics glasses for metal tests), and non hazardous/recycle bare ones (i.e. plastics, paper, organic wastes, glass, debris, tailings). In this respect, it is important to find out whether one may send used cans and packaging materials as well as rests of chemical substances (i.e. oil with PCB) back to suppliers. Some providers are already assuming product chain responsibility and are able to receive their used products or packaging materials back (i.e. used toner for printer machines).

Task 3: *Adequate separation of hazardous and non hazardous wastes on-site.* This task would reduce the amounts of final wastes to be disposed of in “disposal sites for hazardous wastes”. Savings are around US\$ 100 per each ton of correctly separated waste (GLC, 2005).

Task 4: *Research on recycling possibilities in the country for hazardous and non hazardous wastes.* In case of used oil and cars’ batteries, recycling options already exist and they are normally located in the capital city and far away from mining sites. By recycling, disposal costs in landfills for hazardous wastes can be saved to about of US\$ 150 per ton of waste (GLC, 2005).

- b. In order to reduce energy consumption at offices in the field one may follow good operating practices (CPT2). In particular the following ones:

Task 1: *Quantification of energy streams (generation and machines or offices with the highest consumed amounts)*

Task 2: *Analysis of requirements of energy and real consumption (quantities and periods of time). Do requirements match with real consumption? What are the differences? Why? An answer to these questions can lead the company (unit) to better planning.*

Task 3: *Establishment of optimal periods of time or quantities for energy consumption for each relevant machine or place*

- c. To reduce water consumption, leakages or filtrations in the tailings following tasks are directed towards CPT1 and CPT2.

Task 1: *Quantification of water streams (sources of water and processes or areas with the highest consumed amounts)*

Task 2: *Analysis of water requirements and real consumption (quantities and periods of time)*

Task 3: *Establishment of optimal of water for each relevant place*

Task 4: *Permanent monitoring water consumption*

- d. In order to foster an efficient consumption of fuel for transportation one may consider applying CPT3 such as using cleaner energies for vehicles.
- e. CPT2 can be applied in order to reduce spillages of oil or fuel such as an improvement of storage and connection systems.
- f. CPT2 can also be used to reduce the emissions of dust when transporting mineral such as dropping water when transporting or even building in key areas.
- g. CPT1 and CPT2 can be applied in order to increase the treatment of wastewaters such as the implementation of secondary treatment processes (biological treatment) and reuse of water to increase vegetation.

It is important to communicate all these tasks to the personnel of the company (unit) and to train people in specialized tasks such as reuse and recycling.

## CONCLUSION

In this study one has shown meaningful deviations in operation controls in mining related companies operating in Peru. In particular, one has performed 11 environmental audits with respect to the ISO 14001 (2004) and found that deviations can be traced to inadequate management of solid waste (hazardous and non hazardous waste), to non-efficient consumption of electricity, water, oil, and fuel for transportation, to spillages of oil, emissions of dust and wastewater without a proper treatment. Some CP techniques have been discussed in order to mitigate these deviations.

Although it is crucial to apply CP techniques, a more comprehensive solution needs the construction of environmental and eco-efficient performance indicators so

mining related companies could monitor their performance and compare it creating the incentive to compete against each other. Furthermore, these indicators can serve as signals to stakeholders. So, by reporting these indicators there will be an additional incentive to apply CP techniques.

## ACKNOWLEDGEMENTS

Samuel Mongrut is grateful to the Santander Central Hispano Bank Chair and to Universidad del Pacífico for funding the research.

## REFERENCES

- CONAM. 2005. *ISO 14001 en el Perú- 2004*.  
[www.conam.gob.pe/modulos/N\\_ISO/iso14001\\_estadist.asp](http://www.conam.gob.pe/modulos/N_ISO/iso14001_estadist.asp).  
Accessed date: September 28<sup>th</sup> 2005.
- Glave J. M. and Kuramoto J. 2002. *Minería, Minerales y Desarrollo Sostenible en el Perú*. In *Vision Social de la Minería en el Perú*. Breaking New Ground: The Report of the MMSD Project, 567-574.
- GLC. 2005. *Experiencias de Certificación en la Cadena de Proveedores – Estudio de caso en el sector Minero*. Forthcoming in *Made in Germany*, Lima, Peru.
- ISO 14001. 2004. *Environmental Management Systems. Requirements with Guidance for Use*.
- ISO 19011. 2002. *Guidelines for Quality and Environmental Management Systems Auditing*.
- Ministerio de Energía y Minas-MEM. 2005. *Anuario Minero 2004*, Dirección General de Minería.13-39
- McMahon F. 2005. *The Fraser Institute Annual Survey of Mining Companies 2004/2005*, The Fraser Institute, <http://www.fraserinstitute.ca/publications/>.
- Mongrut S. and J. Tong. 2004. Environmental reporting through financial statements: the Peruvian evidence. Working paper, Universidad del Pacífico, Lima.
- Mongrut S. and S. Valdivia. 2005. Benchmarking Environmental Performance Indicators in the Peruvian Mining Sector. Working paper, Universidad del Pacífico and Pontificia Universidad Católica del Perú, Lima.
- UNEP. 2001a. *Cleaner Production – Key Elements*.  
[http://www.uneptie.org/pc/cp/understanding\\_cp/home.htm](http://www.uneptie.org/pc/cp/understanding_cp/home.htm)  
Accessed date: September 28<sup>th</sup> 2005.
- UNEP. 2001b. *Cleaner Production Assessment in Industries*  
[http://www.uneptie.org/pc/cp/understanding\\_cp/cp\\_industries.htm](http://www.uneptie.org/pc/cp/understanding_cp/cp_industries.htm)  
Accessed date: September 30<sup>th</sup> 2005.



## **ADJUSTING FINANCIAL RISK MEASURES TO INDUSTRIAL RISK MANAGEMENT**

**Clemens Werkmeister**

Universität Hohenheim, Stuttgart and Universität Göttingen, Germany

Due to the modifications in banking supervision the Value at Risk (VaR) played a key role in the development of financial risk management in the last decade. Once established there, “at-Risk”-measures started to trickle to the industrial sector. Earnings at Risk (EaR) and Cash Flow at Risk (CFaR) have been suggested as tools not only to control market risks, but also to capture industry’s inherent production technical or management risk. The concept of CFaR is presented and different methods to determine risk distributions for industrial companies are analysed. Most important are the analytical or simulation bottom-up approaches on the one hand and the top-down-comparables approach on the other hand. A modified comparables approach is developed in order to cope with information problems of small or recently developing capital markets. It facilitates the industrial risk assessment and the communication with capital markets while maintaining specific requirements of industrial planning.

### **EXPANDING RISK MANAGEMENT TO THE INDUSTRIAL SECTOR**

Although capital markets offer a broad variety of investment alternatives to hedge risks following individual preferences of the investor, intrafirm dealing with risk is common practice for management. Froot/Scharfstein/Stein (1993) and Nance/Smith/Smithson (1993) explain some reasons, why intrafirm risk management can offer advantages both for management and investors: Most important are imperfect capital markets, especially with respect to costs of financial distress and debt capacity, limited possibility of managers to diversify risks, information and tax asymmetries. Apart of these general reasons, risk management issues arise with specific events: Extreme currency movements draw attention to exchange risks, earthquakes, strikes or other man-made emergency situations to supply chain risks (just remember, for example, the 1999-earthquake in Taiwan, that caused severe problems to some IT-hardware industries) and cases like Enron to the problems of criminal management behaviour. In the academic community, recent proposals to transfer banking supervising regulations to the industrial sector motivate analyses of risk management approaches (for example Homburg/Uhrig-Homburg 2004, Hoitsch/Winter 2004, Kropp/Gillenkirch 2004). The rationale behind this is appealing: The use of “at-Risk”-measures would (i) allow the transfer of established knowledge from the financial to the industrial sector, (ii) create a common risk language between industries and capital markets and (iii) provide industrial companies with a powerful tool to manage their risks.

The transfer of knowledge can be easily seen in the subsequent introduction of commercial software packages, for example the extension of RiskMetrics™ to CorporateMetrics™ (cp. Lee 1999, p. 10). The importance of the common language is emphasized by internal risk measurement approaches that allow different capital underlying depending on the contracted risks. Analogies are, however, sometimes a dubious argument. It is not always clear, whether the problems are sufficiently similar in order to allow the application of similar solutions. In the case of transferring financial risk concepts to industrial risk management this requires the careful examination of several questions. Among them are the adequacy of a certain risk measure at all and the chances of determining a reliable value of the risk measure.

The adequacy of a risk measure requires an analysis to know whether it combines with the goals and risk attitude of a company or not. This question arises because there are some serious doubts about conflicts between the use of Value- or Cash-Flow-at-Risk measures and some axiomatic risk considerations (see Guthoff/Pfingsten/Wolf 1998). The use of VaR is regulated by banking supervisory institutions in order to protect investors and to avoid bank runs. For industrial companies, there is no direct need to follow banking regulations. Apart of few legal requirements of rather general character, such as established by the German KonTraG, specific risk management regulations concentrate on problems like rescue plans in case of fire or chemical accidents. Hence, industrial companies are basically free in the choice of a risk measure and should base their choice on convincing advantages.

The chances of determining a reliable value of the risk measure are important for its use. This point is relevant for the transparency of principal-agent-relations between investors and management as well as inside a company: Risk assessment of industrial investment projects typically requires considerations for a broad variety of risk factors, for the possible outcomes themselves and their probability distribution as well as for the interdependencies and correlations of the outcomes.

In order to check the advantages and problems of transferring financial risk measures to the industrial context, the remainder of the paper is organized as follows: Chapter B introduces the concept of Cash Flow at Risk. Chapter C explains the basic approaches to CFaR-calculation, with emphasis on the special problems of an industrial context. Chapter D resumes the previous results and gives an outlook on the use of the risk measures.

## THE CONCEPT OF CASH FLOW AT RISK

In quantitative cash flow risk management, we start from the assumption, that cash flows are risky, i. e. that the investor assigns to each possible cash flow-outcome a probability or a probability density. So we define cash flow-risk as the probability distribution  $f(x)$  of a company's or a projects operating cash flow  $x$ . From the probability distribution we compute the usual statistics, notably mean, median and variance to describe risky cash flows with few, characteristic numbers. Typical risk management cares more about the bad tail of the probability distribution than about the good outcomes. This is the focus of the “at-Risk”-measures, too.

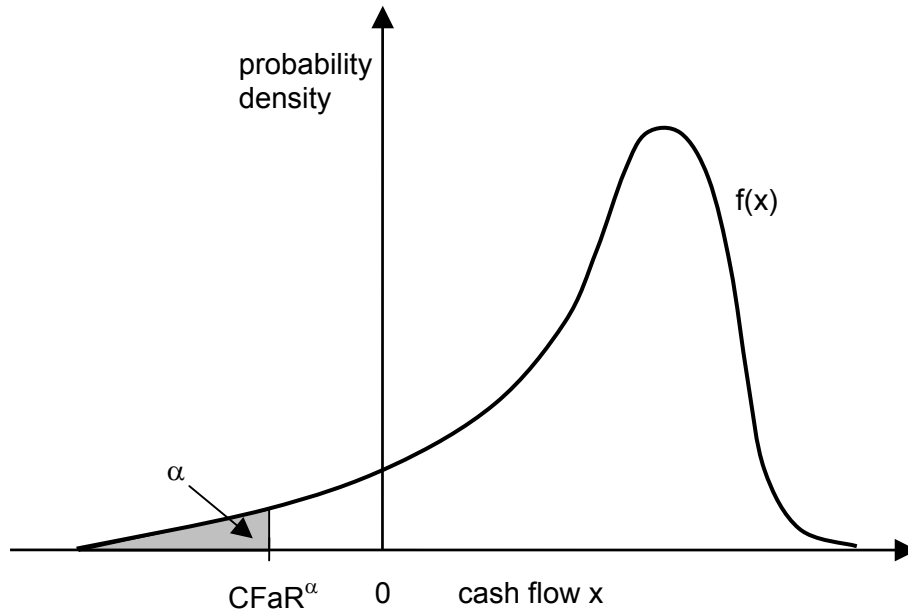
For a stochastic cash flow  $X$  of a period or an investment project with probability function  $f(x)$  and distribution function  $F(x)$ , we call Cash Flow at Risk ( $\text{CFaR}^\alpha$ ) the amount of cash flow, that is reached with probability  $(1-\alpha)$ , respectively that is not reached with probability  $\alpha$  (Jorion 2001). Using the distribution function  $F(x) = \text{prob}(X \leq x)$  and its inverse  $F^{-1}(\alpha)$ , we get:

$$\text{CFaR}^\alpha = F^{-1}(\alpha)$$

and

$$\alpha = \text{prob}(x \leq \text{CFaR}^\alpha).$$

FIGURE 1 shows the idea: The probability level  $\alpha$  corresponds to the area below the probability function  $f(x)$ , which is limited at the right hand side by  $\text{CFaR}^\alpha$ . Therefore, a  $\text{CFaR}^{5\%}$  of -2 mio € means, that with 5 %-probability the cash flow will fall short of 2 mio€, and with 95 %-probability cash flows will stay above this value. Note that different to typical VaR-definitions, the CFaR-definition dispenses sign changes.



**FIGURE 1: Cash Flow at Risk for probability level  $\alpha$**

CFaR is closely related to the lower partial moment zero of the cash flow probability distribution. The lower partial moment zero  $LPM_0(t)$  is the probability that the cash flow does not exceed the critical or target value  $t$  (cp. Fishburn 1977, p. 116):

$$LPM_0(t) = \int_{-\infty}^t (t-x)^0 \cdot f(x) dx = \int_{-\infty}^t f(x) dx = F(t).$$

Setting  $t = CFaR^\alpha$ , we get the shortfall probability:

$$LPM_0(CFaR^\alpha) = F(CFaR^\alpha) = \alpha.$$

Simple probability weighting of the cash flows below the critical value results in the lower partial moment one,  $LPM_1(t)$ . This is the shortfall expectation, the expected value of the difference between the target value and the cash flows, which fall short of the critical value:

$$LPM_1(t) = \int_{-\infty}^t (t-x)^1 \cdot f(x) dx.$$

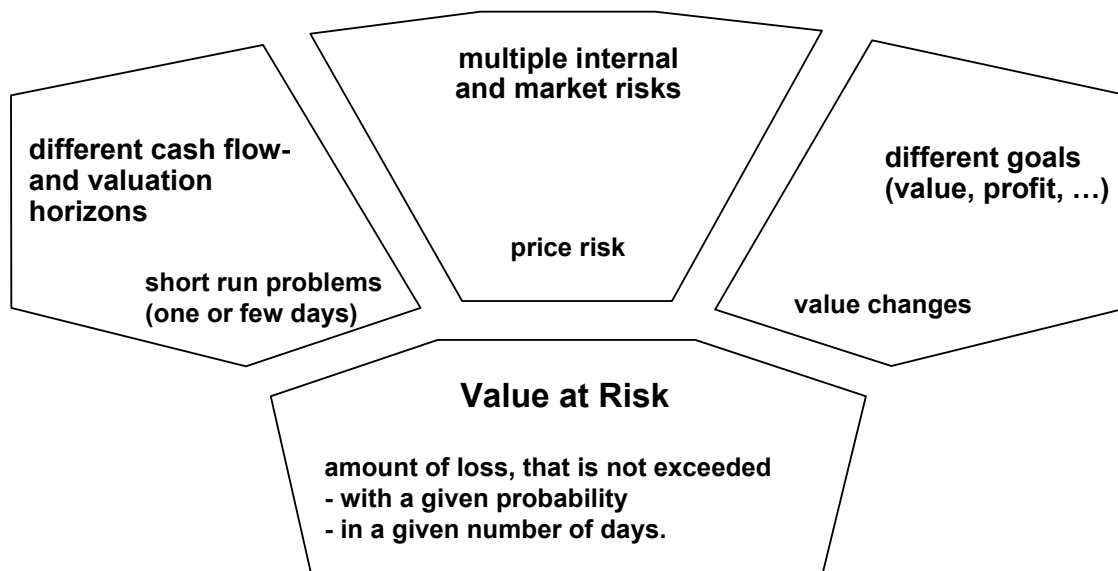
Higher degree shortfall measures (shortfall variance, shortfall curtosis) are defined similarly (see Fishburn 1977). Their interpretation, however, is less intuitive than the shortfall probability or the shortfall expectation.

Since there is no external regulation about the adequate CFaR-probability level  $\alpha$ , management is free to choose  $\alpha$  following its own preferences. The intuition of the determination of  $\alpha$  is straightforward: the lower management sets  $\alpha$ , the more impressive is the  $CFaR^\alpha$  of a project. Taking into consideration that a 1 %-probability level

might be very sensitive to random influences (see Pfingsten/Wagner/Wolferink 2004, p. 89), a 5 %- or 10 %-level seems to be more appropriate for industrial purposes.

Although the idea of using CFaR as a measure of risk seems very appealing, its implementation creates various problems: One of them is the kind of risk that is included in the analysis. While it seems in most cases preferable to use a comprehensive risk measure that copes with all relevant risk factors, from a practical point of view a concentration on specific risks may be more feasible. A second problem is that every cash flow or profit risk measure has to deal with the timing of cash flows. Cash flows arrive in different points in time and any focus on periodic cash flows creates incentives to postpone or anticipate payments to meet a required target or manager-specific preferences. Aggregation of cash flow risks to a risky present value creates problems, however, which are far from commonly accepted solutions (see Kruschwitz/Löffler 2005 for a brief survey). Furthermore, this aggregation restricts the possibilities to control for specific periodic cash flows. These problems are addressed in very convincing manner in the Value-at-Risk-concept for financial risks. The value at risk concentrates on short run problems, which mainly stem from price risks for financial assets and result in value changes (see

FIGURE 2). The focus on short-run value effects of market price risks facilitates the cash flow problem, and it is possible to capture a good part of the risk of financial institutions using the Value at Risk. The same applies to financial risks of industrial companies, i. e. risks of currency exposures or interest risks. However, in industrial companies, financial risks are not the only important risk factor and even the price risks of commodities do not correspond to the typical risk behaviour of financial assets (see Gebhardt/Mansch 2001, p. 127; Geman 2005, pp. 49 ff.). Any industrial risk measure has to cope with an adequate spectrum of risk factors and risk consequences.



**FIGURE 2: Risk specification with Value at Risk**

### **FORECASTING INDUSTRIAL COMPANIES' CASH FLOW AT RISK**

The previous considerations point out the importance of the probability distribution for cash flow risk analysis. In order to map a comprehensive spectrum of risk factors and their influence on cash flows, there are two basic approaches, namely bottom-up-approaches and the comparables approach (see, for example, Bartram 2000). Bottom-up approaches rely on a business model that identifies cash flow components

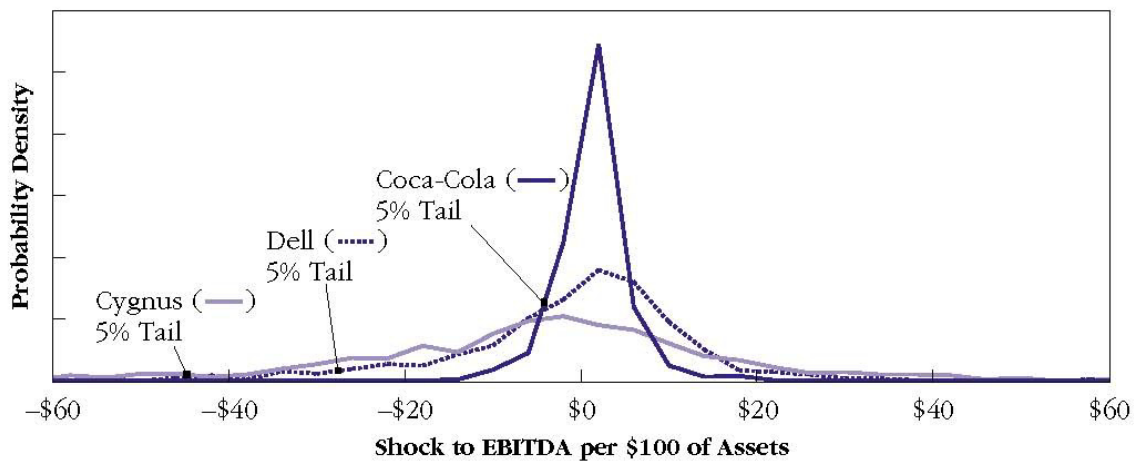
(sales, variable costs, fixed expenses, interests and so on) and the risk exposure of each component. The probability distribution of the relevant cash flow results from the duly aggregated probability distributions of the components. The use of business risk models allows to distinguish several tasks in cash flow forecasting: First, the identification of relevant variables and their interrelation, second the forecasting of the probability information for the risk factors and their correlation and third the consolidation of the individual risk factors probabilities to the over-all cash flow probability. The identification of relevant variables is part of every decision model, let it be stochastic or deterministic. Forecasting component probabilities and consolidating them, however, are specific tasks of business risk models. They can be addressed in different ways.

In some cases, the stochastic characteristics of the components and its interrelation allow an analytical aggregation of component variances to cash flow variance (cp. Lee 1999, p. 111). This is called the variance-covariance approach. Its use is appropriate in some cases with normal or lognormal probability distributions of the business models cash-flow components (see Schweitzer/Troßmann/Lawson 1989, pp. 228 ff.; Jaedicke/Robichek 1964, pp. 924 ff.; Dickinson 1974; Hilliard/Leitch 1975, pp. 69 ff.). Linear relationships between sales volume and price with stochastic error terms have been included in early extensions of industrial cash-flow-models (see Morrison/Kazcka 1969, pp. 330 ff.; Constantinides/Ijiri/Leitch 1981, pp. 417 ff., Karnani 1983, pp. 187 ff.). They imply in the well-known quadratic sales function. Assuming a quadratic cost function, Yunker/Yunker (1982, p. 25) get stochastic profits. If the error terms are normally distributed, this applies to the profit distribution, too. The probability distributions of the variance-covariance approach are easy to handle, its application however is quite limited by the small range of probability distributions that enable analytical solutions. Other problems arise with the handling of dynamic effects, mean reversion or cointegration relationships (see Lee 1999, p. 112). Such effects, however, are a common behaviour of commodity prices as one component of industrial financial risk (see Gebhardt/Mansch 2001, p. 127; Geman 2005, p. 52).

By far more open with respect to the suitable probability distributions is the use of historical observations of the cash flow components. Actually this approach does not require any assumption about component probability distribution at all. It simply puts component observations of past periods into the business model and calculates a cash flow for every period. With one cash flow for each period, the chances to get a reliable cash flow probability distribution using this historical simulation approach clearly depend on the number of periods. Even with a fair number of historical observations, remains just one fundamental problem. Cash-Flow-at-Risk-analyses are conceived to deal with the danger of huge losses which by nature have a very small probability. Hence one should suppose, that historical observations do not contain the really dangerous cases, even because the company would not have survived it. This shortcoming of any historical risk analysis is the reason for pure simulation methods, especially Monte-Carlo-simulations as introduced by Hertz (1964) and others.

The idea of Monte-Carlo-simulations is very appealing. Combined with the Cholesky-decomposition it is able to cope with correlated risk factors (see Jorion 2001, pp. 303 ff.; Henking 1998, Hager 2004, Deutsch 2004, Auer 2002). Its use, however, depends much on the quality of input data. External commodity price risk data are more difficult to obtain than are interest rate or exchange rate data (see Gebhardt/Mansch 2001, p. 133). The same applies often to internal process risk data. The difficulties to determine industrial cash flow risks using bottom-up risk aggregation inspired search for other approaches. Apart from scenario techniques, case studies and other less quantitative approaches, external benchmarking offers an important method.

Stein/Usher/LaGattuta/Youngen (2001) presented a comparables approach which intends to gain the cash flow risk directly from historical cash flow variations of a peer group of similar companies. FIGURE 3 shows an example of their results.



$$\text{CFaR}_{\text{Cygnus}}^{5\%} = -47,31 \text{ US-}\$, \text{ CFaR}_{\text{Dell}}^{5\%} = -28,50 \text{ US-}\$, \text{ CFaR}_{\text{Coca-Cola}}^{5\%} = -5,23 \text{ US-}\$$$

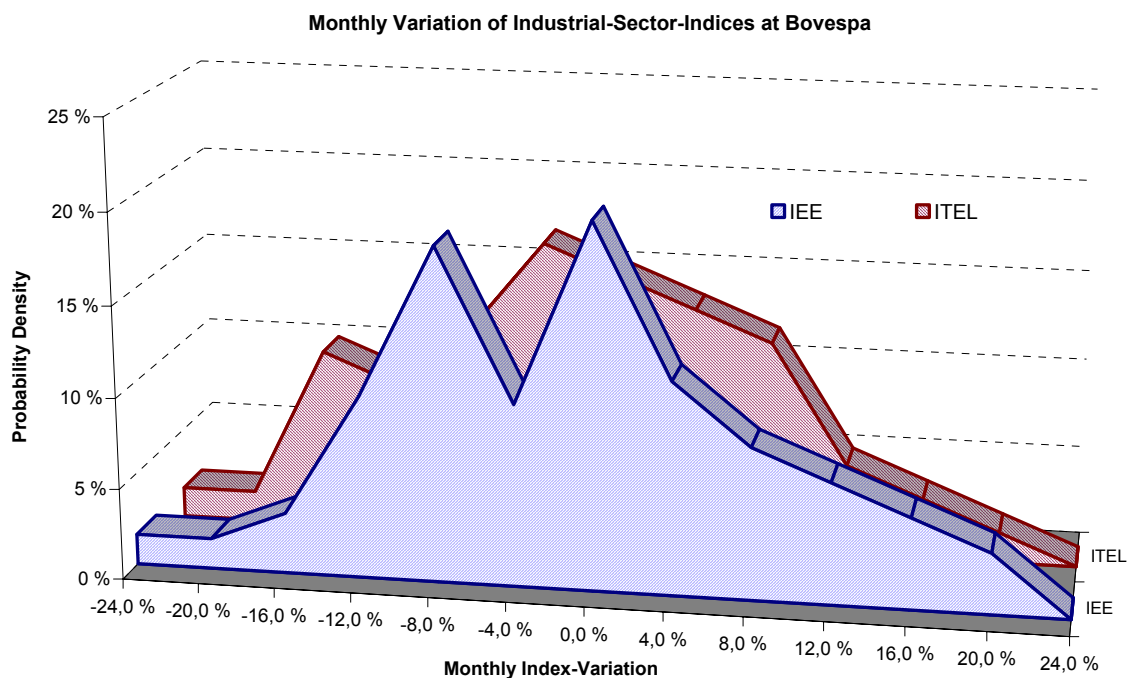
**FIGURE 3: 5 %-Cash Flow at Risk for Coca-Cola, Dell and Cygnus**  
(see Stein/Usher/LaGattuta/Youngen 2001, p. 9)

The comparables approach has some merits: it uses a highly standardized method that looks directly at companies overall cash flow and avoids lot of discussion about risk factor probability distributions or intermediate aggregation problems. Especially, since it gives the cash flow probability distribution in a non-parametric way, it dispenses all the critical assumptions about normalcy of external shocks. Finally, its risk estimates represent the average risk of the peer group and can be actualized every three months with quarterly data at relatively low-cost. These characteristics make it interesting for capital market purposes. However, there are some shortcomings of the comparables approach too: Some of the shortcomings are common to all historical peer group benchmarks.

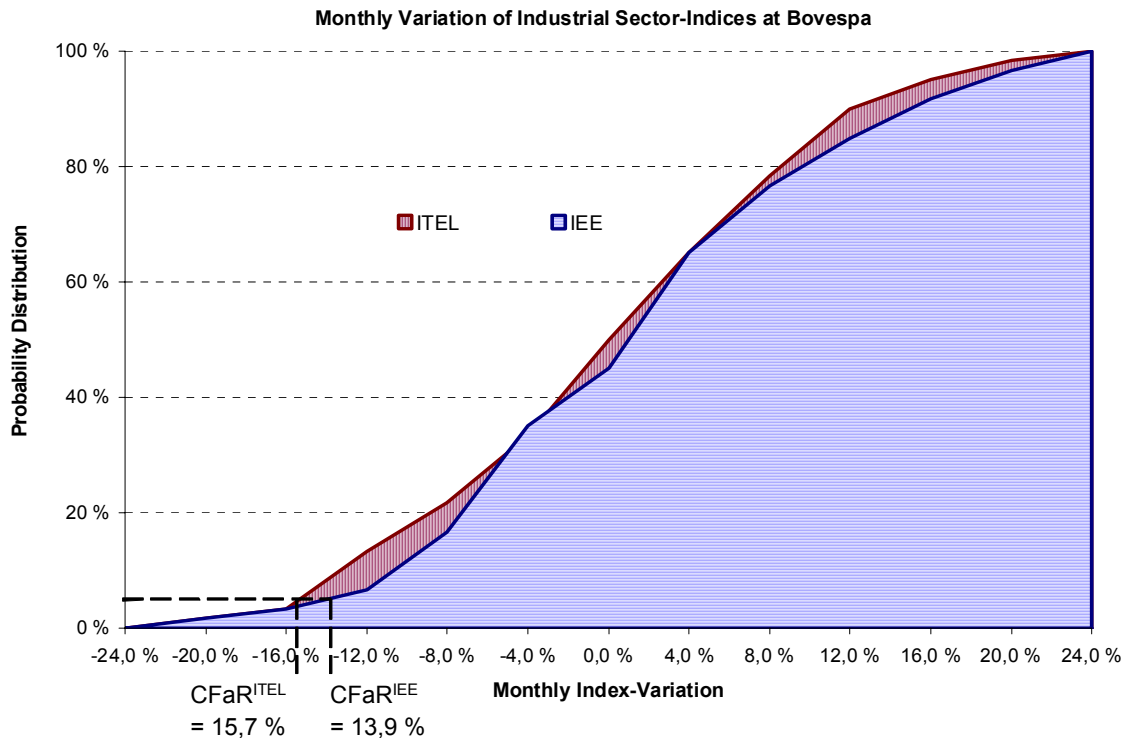
Generally, one has to ask, whether risk estimates based on historical cash flow changes can be used for future outcomes. The same applies to risk estimates that stem from peer group companies with different business models. Scepticism is reinforced if the peer group contains companies of totally different areas, as is the case with retailers in the Dell-peer group in Stein/Usher/LaGattuta/Youngen (2001). An additional problem is to get a sufficient sample of peer companies. This problem is typical for small or recently developing capital markets where relatively few companies are listed on stock exchanges or publish quarterly results. Other shortcomings depend on the application of the risk estimates. While company-wide risk estimates based on historical cash flows may be very helpful for capital markets, they offer less information for internal investment decisions or for the control of division managers. It turns out to be difficult to break down the easy-to-compute and easy-to-compare characteristics of the company-wide comparables approach to divisional or operating levels. The comparables approach is a top approach, not a top-down approach.

To cope with some of these problems, we suggest a modified version of the comparables approach. Instead of quarterly financial result changes of diversified peer groups, we concentrate on changes of sector-specific stock-price-indices. This modifica-

tion offers several advantages: (i) stock prices and their changes internalize market forecasts of future outcomes to the extent that the underlying market is efficient, (ii) index changes aggregate information about different companies whose quarterly financial results may be difficult to obtain or to compare, (iii) index changes are available for different time horizons (daily, monthly, quarterly and yearly changes), (iv) sector-specific indices can be used to break down companies global risk estimates to the divisional level, if the divisions belong to different industrial sectors. FIGURE 4 shows the distributions of the changes of the telecommunication stock index (Índice Setorial de Telecomunicações - ITEL) and the electric energy stock index (Índice de Energia Elétrica - IEE) at the São Paulo stock exchange (BOVESPA). They are calculated on a monthly basis for the years 2000 to 2004. FIGURE 5 shows the corresponding probability distribution. It is easy to see that the index changes are not normally distributed. There are fat tails to the negative changes that justify specific risk considerations. FIGURE 5 further makes it clear, that from a risk averse point of view the electric energy index nearly dominates the telecommunication index. Hence,  $IEE-CFaR^{5\%}$  is less negative than  $ITEL-CFaR^{5\%}$  and the same applies to all risk-levels  $\alpha$ . This information is helpful for the further planning of investors or companies.



**FIGURE 4: Probability Density of Monthly Index Variations in the Brazilian Telecommunication and Energy Sector**  
(Source: Calculated From Bovespa-Data; <http://www.bovespa.com.br>)



**FIGURE 5: CFaR of Monthly Index Variations in The Brazilian Telecommunication and Energy Sector**  
 (Source: Calculated From Bovespa-Data; <http://www.bovespa.com.br>)

## CONCLUSION AND OUTLOOK

The paper introduced to the concept of CFaR and its analogy to VaR. It presented different approaches to forecast the risk distribution of outcomes that is a precondition to calculate CFaR for industrial companies. Cash-flow at Risk draws attention from the desired outcomes (the chances of a project) to the worse tail of possible outcomes, providing at least rough insight to its possible extent. The appeal of the comparables approach to risk distribution forecasting comes from its publicly available and revisable information base. The approach was modified to cope with specific forecasting problems of small or recently developing capital markets. As an additional characteristic, the modification allows to determine divisional risk estimates for diversified companies and to forecast with different planning horizons. Further research, however, will be necessary for the application of the risk information. Given the conflicts between the use of Value- or Cash-Flow-at-Risk measures and axiomatic risk considerations (see Guthoff/Pfingsten/Wolf 1998), the use of  $\text{LPM}_1$  or related risk measures may be more appropriate for industrial companies. Nevertheless, the presented modification offers an intuitive and feasible way to forecast the necessary risk distributions and to prepare decisions on industrial investments.

## REFERENCES

- Bartram, S. 2000: Verfahren zur Schätzung finanzwirtschaftlicher Exposures von Nichtbanken. In L. Johanning u. B. Rudolph (Eds.), *Handbuch Risikomanagement. Bd.: 2: Risikomanagement in Banken, Asset-Management-Gesellschaften, Versicherungs- und Industrieunternehmen*, pp. 1267-1294. Bad Soden/Ts.
- Bühler, W. 1998. "Risikocontrolling in Industrieunternehmen". In C. Börsig and A. G. Coenberg (Eds.), *Controlling und Rechnungswesen im internationalen Wettbewerb*, pp. 205-233. Stuttgart.



- Constantinides, G. M., J. Ijiri and R. A. Leitch. 1981. Stochastic Cost-Volume-Profit Analysis with a Linear Demand Function. *Decision Sciences* (12): 417-427.
- Auer, M. 2002. *Methoden zur Quantifizierung von Marktpreisrisiken. Ein empirischer Vergleich*. Köln.
- Deutsch, H.-P. 2004. *Derivate und interne Modelle*. 3rd ed. Stuttgart.
- Dickinson, J. P. 1974: Cost-Volume-Profit-Analysis Under Uncertainty. *Journal of Accounting Research* (12): 182-187.
- Fishburn, P. C. 1977. Mean-Risk Analysis with Risk Associated with Below-Target Returns. *The American Economic Review* (67): 116-126.
- Froot, K., D. Scharfstein and J. Stein. 1993. Risk Management: Coordinating Investment and Financing Policies. *Journal of Finance* (48): 1629-1658.
- Gebhardt, G. and H. Mansch (Eds.). 2001. *Risikomanagement und Risikocontrolling in Industrie- und Handelsunternehmen. Empfehlungen des Arbeitskreises "Finanzierungsrechnung" der Schmalenbach-Gesellschaft für Betriebswirtschaft e.V. Sonderheft 46 der ZfbF*. Handelsblatt-Verlag, Düsseldorf/Frankfurt.
- Geman, H. 2005. *Commodities and Commodity Derivatives*. Chichester 2005.
- Guthoff, A., A. Pfingsten and J. Wolf. 1998. Der Einfluss einer Begrenzung des Value at Risk oder des Lower Partial Moment One auf die Risikoübernahme. In A. Oehler (Ed.) *Credit risk und Value-at-risk-Alternativen*. pp. 110-153, Stuttgart.
- Hager, P. 2004. *Corporate Risk Management. Cash Flow at Risk und Value at Risk*. Peter Lang. Frankfurt a. M.
- Henking, A. 1998. *Risikoanalyse unter Berücksichtigung stochastischer Abhängigkeiten*. München.
- Hertz, D. A. 1964. Risk Analysis in Capital Investment. *Harvard Business Review* (42): 95-106.
- Hilliard, J. E. and R. A. Leitch. 1975. Cost-Volume-Profit Analysis Under Uncertainty: A Log Normal Approach. *The Accounting Review* (50): 69-80.
- Hoitsch, H.-J. and P. Winter. 2004. Die Cash flow at Risk-Methode als Instrument eines integriert-holistischen Risikomanagements. In D. Hachmeister (Ed.), *Risikomanagement und Risikocontrolling. Sonderheft 3 der ZfCM. Zeitschrift für Controlling und Management* (48): 235-246.
- Homburg, C. and M. Uhrig-Homburg. 2004. Zentrales und dezentrales Risikocontrolling in Industrieunternehmen. *Zeitschrift für betriebswirtschaftliche Forschung* (56): 311-332.
- Jaedicke, R. K. and A. A. Robichek. 1964. Cost-Volume-Profit Analysis Under Conditions of Uncertainty. *The Accounting Review* (39): 917-926.
- Jorion, P. 2001: *Value at Risk: the New Benchmark for Managing Financial Risk*. 2nd ed. New York et al.
- Karnani, A. 1983: Stochastic Cost-Volume-Profit Analysis in a Competitive Oligopoly. In: *Decision Sciences* (14): 187-193.
- Kropp, M. and R. M. Gillenkirch. 2004. Controlling von Finanzrisiken in Industrieunternehmen. In D. Hachmeister (Ed.), *Risikomanagement und Risikocontrolling. Sonderheft 3 der ZfCM. Zeitschrift für Controlling und Management* (48): 86-96.
- Kruschwitz, L. and A. Löffler. 2005. Ein neuer Zugang zum Konzept des Discounted Cashflow. *Journal für Betriebswirtschaft* (55): 21-36.
- Lee, A. Y. 1999. *CorporateMetrics™ Technical Document*. RiskMetrics Group 1999.
- Morrison, T. A. and E. Kaczka. 1969. A New Application of Calculus and Risk Analysis to Cost-Volume-Profit Changes. *The Accounting Review* (44): 330-343.
- Nance, D. R., C. W. Smith, Jr. and C. W. Smithson. 1993. On the Determinants of Corporate Hedging. *The Journal of Finance*. (48)1: 267-284.
- Pfingsten, A., P. Wagner and C. Wolferink. 2004: Eine empirische Analyse der Rangkorrelationen zwischen verschiedenen Risikomaßen. In G. Fandel, B. Rudolph und W. Kürsten (Eds.), *Finanzwirtschaftliche Information, Anreizgestaltung und Kontrolle. ZfB-Ergänzungsheft 2/2004. ZfB* (64): 79-103.
- Schweitzer, M., E. Troßmann and G. Lawson. 1989. *Break-even-Analyses*. Chichester, New York.
- Stein, J., S. E. Usher, D. LaGattuta and J. Youngen. 2001. A Comparables Approach to Measuring Cash-flow-at-Risk for Non-Financial Firms. *Journal of Applied Corporate Finance* (13)4: 8-17.
- Yunker, J. A. and P. J. Yunker. 1982. Cost-Volume-Profit Analysis under Uncertainty: An *Integration of Economic and Accounting Concepts*. *Journal of Economics and Business* (34): 21-37.



## **SUPPLY CHAIN INTEGRATION: IMPROVEMENTS OF GLOBAL LEAD TIMES WITH SCEM**

**Julia Pahl <sup>a</sup>, Stefan Voß <sup>a</sup>, Andreas Mies <sup>b</sup>**

<sup>a</sup> University of Hamburg, Hamburg, Germany

<sup>b</sup> Mummert Consulting AG, Hamburg, Germany

**Supply Chain Integration is about integrating supply chain partners in a network and ensuring the uninterrupted flow of goods and information in order to increase global efficiency and responsiveness. As organizations move from creating plans for individual production lines to entire supply chains it is increasingly important to recognize that decisions concerning utilization of production resources impact the lead times that will be experienced (see, e.g., the bullwhip effect). Long lead times may impose high costs due to raised work in process (WIP) levels and larger safety stocks caused by increased uncertainty about production prerequisites and constraints. Without appropriate communication and planning models, decreased lead times at one link of the supply chain do not automatically lead to improvements in global supply chain lead times. Supply Chain Event Management (SCEM) addresses the problem of identifying deviations between an original plan and its execution across the whole network and generates corrective actions according to predefined rules and, thus, improves decision making. We examine the concept of SCEM and validate its effectiveness for production planning with load dependent lead times.**

### **INTRODUCTION**

The dynamics and the globalization of markets imply competition in time-based factors like flexibility or responsiveness to consumers, especially in case of variable demand patterns and various supply chain partners dispersed around the world (see (Huddleston, 2002), (Lee, 2000)). We define lead times as the time between the release of an order to the shop floor or to a supplier and the receipt of an item. Considerations about lead times are crucial to global competitiveness, because long lead times impose high costs due to rising WIP inventory levels and larger safety stocks attributable to increased uncertainty about production prerequisites and constraints (Karmarkar, 1989). Leadership of firms is achieved not only through a competitive price, but especially through factors like quality, direct guaranteed (reliable) deliverability, and short lead times (Andries & Gelders, 1995).

In recent years and with the literal explosion of new technologies considering computer power, speed and memory storage, a vast range of supply chain management (SCM) software systems and methods has flooded the market with the aim at overcoming, e.g., the time sensitive information provision problem offering tools and methods for better planning and control of the overall supply chain. Among these are, e.g., Advanced Planning Systems (APS), Enterprise Resource Planning (ERP), Quick Response Manufacturing (QRM), and SCEM (Supply Chain Event Management) just to mention a few. Problems arise when the management concepts behind this software are not well developed or these tools are not applicable or modifiable in order to reflect reality of shop floors. Furthermore, present tools and methods do not provide support to “intelligent” planning and decision making which is partly because most software systems have primarily evolved from advanced bookkeeping systems. This is, e.g., the case of Material Requirements Planning (mrp) and Manufacturing Resource Planning (MRP II) systems with its inherent problems discussed at a great length in the literature. For further reading see, e.g., (Zijm, 2000). A severe problem is the omission of capacity restrictions and nonlinear dependencies as, e.g., the relationship between lead times and

WIP (see (Voß & Woodruff, 2003) and (Voß & Woodruff, 2004)). Further assuming “worst case” lead times for production planning in order to have enough buffer time leads to increased WIP and finished goods inventory (FGI) in the production system and, consequently, to waiting times which is addressed as the *lead time syndrome* in the literature (see (Zijm, 2000)). Intensifications arise when uncertainties and unexpected events like machine breakdowns and rush orders occur. In order to account for load dependent lead times it is mandatory to consider both events at the tactical and operational stage, because these two levels are linked very tightly and influence each other significantly (see (Dauzère-Pérès & Lasserre, 2002)).

The concept of SCEM can help to make the production process more transparent (“visible”) for the decision maker within the supply chain helping to identify unexpected events as soon as they happen. This is especially important in times of outsourcing rendering supply chain processes more and more collaborative and complex through additional transportation modes, different handling methods etc. and further increasing time sensitivity with the application of Just In Time (JIT). This results in an increased vulnerability to irregularities and disruptions in supply processes (Zimmermann & Paschke, 2003). SCEM detects events defined as deviations between plan and its execution across the multitude of processes and actors in the supply chain in time, quantity or quality (Mies & Voß, 2004) and triggers the necessary, time sensitive information in order to launch corrective actions according to predefined rules (Otto, 2003). The main focus of SCEM is proactive behavior, viz. to act before a problem occurs (Zimmermann et al., 2006). Building on the concept of visibility in the supply chain considering internal as well as external resources of a company it allows systems, such as APS, to improve the quality of production plans and, therefore, to avoid unexpected events like capacity bottlenecks, inventory gaps or production changes. Companies’ experience, e.g., 20% of inventory cost reductions and 30% reduction of supply chain cycle times (Vernon, 2004) through SCEM applications. It is a recent concept which has attracted only little attention in the literature so far. In this paper we examine the concept of SCEM and validate its effectiveness for production planning with load dependent lead times. We show that the improvements of transparency in the production planning can lead to significant lead time reductions of supply chains.

This paper is organized as follows. The following Section 2 highlights the theoretical concept of SCEM and the usage in practice with a critical evaluation of current approaches and software applications. Section 3 examines load dependent lead times giving a short overview on the problematic nature. Section 4 introduces formal modeling approaches of SCEM. Section 5 presents a modeling approach including SCEM as well as load dependent lead times in a supply chain planning model. The paper concludes with a critical evaluation and future research directions.

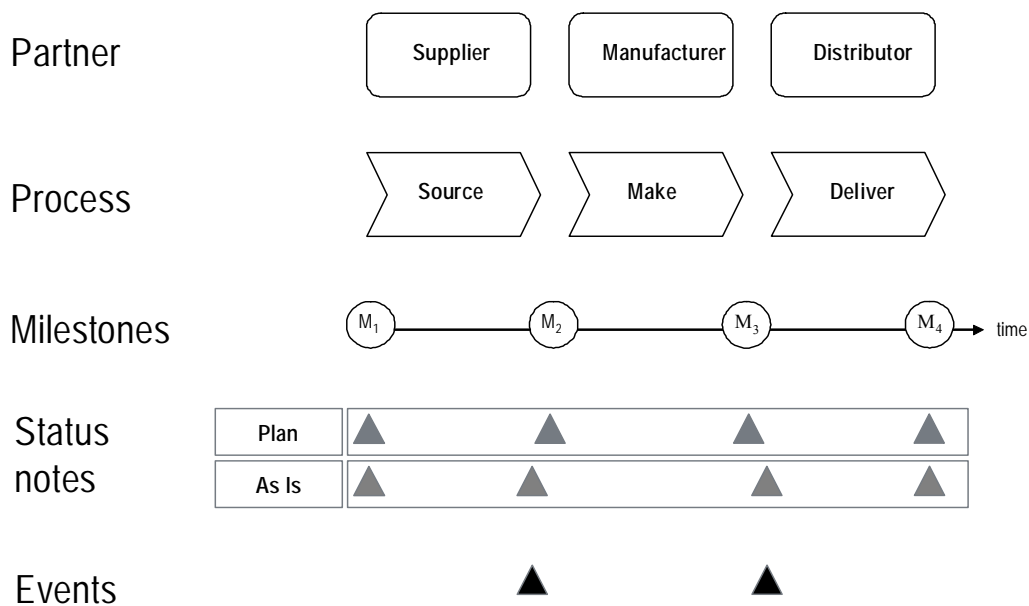
## SUPPLY CHAIN EVENT MANAGEMENT

As plans and forecasts tend to deteriorate in accuracy due to continuously changing circumstances, SCEM provides an alerting mechanism and enables companies to respond quickly – or automatically – to unplanned events so that deviations from the plan can be considered at an early stage providing information based action opportunities (see (Mies & Voß, 2004), (Vernon, 2004)).

### Theoretical Concept of SCEM

SCEM has evolved as an extension of process control (see (Marabotti, 2005)). Since SCEM applications are conceived as *add on*’s, they need to be integrated into the overall SCM systems world (APS, ERP, Data Warehousing solutions, etc.) and linked with real-time applications like Electronic Data Interchange (EDI), Radio Frequency

Identification Device (RFID), mobile devices etc. (see (Zimmermann & Paschke, 2003)) which speeds up the supply chain by delivering status notes of parts, products and deliveries.



**FIGURE 1: SCEM - The process oriented view**

SCEM is an *event oriented* control concept for logistic processes where a process is defined as a continuous sequence of *milestones* with milestones being sensors deliberately positioned in the supply chain that report, processes, forwards and compares state notices to the plan, e.g., notices generated through tracking and tracing (T&T) systems. Thus, SCEM acts like a filter so as to avoid the time consuming search of deviations for the manager which can concentrate on value added activities, e.g., project control and decision making (Kilger et al., 2005). Only specifically classified notices (events) give impulses for action; see FIGURE 1 (Bretzke, 2003). Event information – categorized in high-, medium- or low-urgency alerts – are communicated to the responsible manager providing decision alternatives generated by norms and rules (Lane, 2002). By simulating the effects of occurred events, other events can be released in order to anticipate problems in the supply chain. Accordingly, SCEM acts like a mediator between supply chain planning (SCP) and -execution (SCE) by *monitoring, notifying, simulating, controlling* and *measuring* activities in the supply chain (see (Mies & Voß, 2004), (Otto, 2003)).

The success of every supply chain depends on the ability to prevent or resolve events. SCEM can use the following four modes to manage an event: *repair, re-schedule, re-plan* and *learn* (Otto, 2003). The *repair* mode describes an immediate reaction to an occurred deviation. The *re-schedule* mode re-calculates the production plan of the remaining processes and communicates the updated milestones to the relevant partners whereas the *re-plan* mode includes the re-planning of the complete process in case of incisive events. The *learn* mode includes the modification of planning policies derived from continuous analysis of occurred events.

#### **Analysis of the Status Quo of SCEM**

Regarding software, SCEM is a feature-functionality subset of SCM suites with its underlying problems and weaknesses influencing also the SCEM tool (see (Huang, 2002)). A study which analyses SCEM gives reference for the need of SCEM function-

ality in practice, but companies see more imperative call for action regarding the underlying systems themselves, e.g., T&T and SCM, emphasizing that the required environment for SCEM is not sufficiently matured so far. A general problem of SCEM applications lies in the definition of *deviations* (predefined thresholds) in order to avoid a flood of alerts when slight deviations occur. Since SCEM aggregates and processes data and information from other systems it heavily depends on the accuracy of this underlying data. If the data is outdated, because state notices and changes are registered with delay (or not at all), the system will send alerts and change proposal messages based on incorrect assumptions about reality (see (Kilger et al., 2005)). This is also subject to a study of (Kauremaa et al., 2004) that examines the general use of information technology (IT) in logistics and SCM which shows that, until now, only few supply chain partners are integrated with their SCM systems. Consequently, flexible supply networks using and sharing contemporary IT solutions are still a vision, but, nevertheless, on the way. For more detail see (Kauremaa et al., 2004). Besides, the decision support function of SCEM systems is still in its infancy according to (Lane, 2002). Nevertheless, the transparency within the supply chain provided by the SCEM concept and quick response generating preventive action obviously results into reduced lead times (see (Songini, 2001)). The higher the information visibility, the better the coordination of ordering, production and distribution with reduced costs and lead times avoiding effects highlighted with the Bullwhip effect.

### LOAD DEPENDENT LEAD TIMES

Lead times are amongst the most important properties of items in the production planning and SCM, because short lead times are the key competition factor influencing flexibility and responsiveness to consumer, and service level, especially in case of variable demand patterns. They depend significantly on decisions about the production mix, scheduling policies, and system workload presented by WIP, FGI and capacity utilization (see (Asmundsson et al., 2002), (Asmundsson et al., 2003), (Caramanis & Anli, 1999)). This is ignored by traditional production planning models such as, e.g., mrp or MRP II, ERP or APS. In fact, many problems are inherent in these systems (see (Pahl et al. 2004), (Pahl et al., 2005)). One underlying assumption is a fixed or “*worst case*” lead time so that lead times are regarded as an attribute of an item (see (Voß & Woodruff, 2004)) although it is rather a consequence of system dynamics and dependencies. The *worst case* assumption serves to build buffer time rashly releasing orders in the production system, thus increasing system workload and, consequently, lead times which was attempted to be avoided. Therefore, lead times should not be fixed input parameters to production planning, but rather a result of the planning process. Another problem is that the afore mentioned systems lack of capacity constraints or model capacity as an upper bound with costs imposed only when the capacity constraint is violated, i.e. it tightens only in case of 100% capacity utilization. Nevertheless, empirical evidence demonstrates that lead times increase nonlinearly long before full resource utilization is reached. Thus, production plans tend to be inaccurate, because planned and realized lead times differ. Information inclusion about workload and unforeseen events which alter production plans could avoid or decrease load dependent lead times.

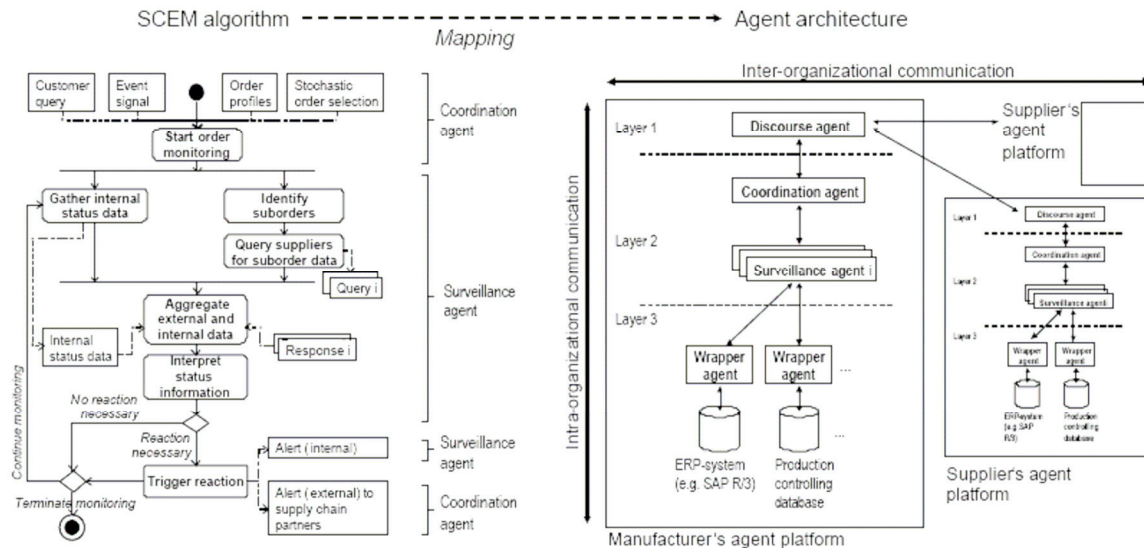
There exist several ways in the literature to account for load dependent lead times which range from indirect modelling approaches and queuing analysis to direct modelling approaches. The indirect modelling approaches try to influence parameters that have an effect on lead times such as decisions on release policies, influences on the demand side or shifts away from bottlenecks in order to increase capacity, lot sizing and production system characteristics (see e.g. (Missbauer, 1998)). Queuing analysis and

network models highlight the relationship between the capacity, loading and production mix as well as the resulting WIP levels and effects on lead times providing important information on the causes of congestion phenomena (e.g. (Chen et al., 1988)). Finally, direct approaches of modelling load dependent lead times integrate the nonlinear dependency between lead times and workload using clearing functions which model capacity as a function of system workload with a clearing factor that specifies the fraction of actual WIP “cleared” by a resource in a given time period. Work in this direction is provided by (Asmundsson et al., 2002), (Asmundsson et al., 2003), (Graves, 1986), (Karmarkar, 1989), (Missbauer, 1998). However, there does not exist work relating SCEM to load dependent lead times. In order to analyse how SCEM can be integrated in production planning systems (models) accounting for load dependent lead times we investigate the state of the art modelling approaches in the next section.

### FORMAL MODELING APPROACHES

Approaches to integrate the SCEM concept into supply chains include Petri nets (Liu et al., 2004) or agent based technology (see (Zimmermann & Paschke, 2003), (Zimmermann et al., 2006)). (Liu et al., 2004) present a Petri net approach which formulates supply chain event rules for analysing the cause-effect relationships between events. They categorize possible events in *task state related events*, *events produced by a task* and *external events* and present seven basic event patterns in order to capture cause-effect relationships which can be combined as building blocks so as to create more complex Petri-nets reflecting supply chains and their interdependencies or interactions. Agent-based technology is primarily used in supply chains to optimise schedules through decentralized coordination mechanisms or to support planning and execution of processes (see (Fox et al., 2000)). Nevertheless, an agent-based SCEM concept for order management is presented by (Zimmermann & Paschke, 2003). They argue that most SCEM systems whose capabilities and functionalities are added to ERP systems do not allow for adaptive behaviour regarding environmental changes resulting in extensive and time-consuming customisation of such systems and increased related costs which can be avoided using an agent-based approach. The authors provide SCEM functionalities concentrating on information gathering from different data sources across the supply chain with diverse types of agents (see Figure 2) analysing and comparing the data and sending reports and alerts (exception messages) if critical values are reached in order to monitor orders and suborders.

The SCEM algorithm is mapped on the agent architecture composed of three layers of agents: discourse agents, coordination agents, surveillance agents, and wrapper agents where the *discourse agents* on the first layer communicate the monitored information across the supply chain interacting with the other supply chain partner’s agent systems. The tracking function is located at the second and third layer where the *coordination agent* executes the order profiling function triggering *surveillance agents* for every single monitored order that collects status information from, e.g., ERP systems, and communicates it to the discourse agents. *Wrapper agents* are located at the various information systems allowing for query functionalities. The monitored event data and state notes are stored in a data warehouse for analysis purposes through, e.g., data mining methods.



**FIGURE 2: Agent-based software architecture (Zimmermann & Paschke, 2003)**

In order to demonstrate the influence of SCEM on lead times, we provide a conceptual approach using key performance indicators (KPIs). We focus on the SCEM learn-function and on how it can be effectively integrated in mathematical programming models considering load dependent lead times for better production plans.

### MODELING APPROACH OF SCEM INCLUDING LOAD DEPENDENT LEAD TIMES

Taking advantage of the functionality of the SCEM concept for production planning we focus on the learning and knowledge management component of SCEM. Therefore, we emphasize on *measures* derived from data analysis obtained by, e.g., surveillance agents as exposed above, e.g., protocols of delayed shipments, machine breakdowns leading to further delays or the need for re-routing etc., or by data mining methods in combination with data warehouse applications. These measures are then used to update (enhance) production plans in the short/ midterm run (e.g., “if machine X breaks down twice in a time period, then use machine Y”) and to detect and repair inherent process problems in the long run (e.g. “buy a new machine of type X”) in order to build a reliable supply chain with on-time arrivals of orders or manufacturing parts, thus low WIP inventories, short lead times and increased customer service. For a visualization of the concept see FIGURE 3. The Supply Chain Process Management (SCPM) comprises the SCEM functionality of data collection and event evaluation and the Supply Chain Performance Management (SCpM) with the functionality of documentation analysis, learning and derivation of KPIs through aggregation and evaluation of events.

With the help of the well known Supply Chain Operations Reference – model (SCOR) which allows for representing, analyzing and configuring complex supply chains and provides measures and indicators from highly aggregation to very detailed operational level, we can derive KPIs relevant for lead times. Some selected KPIs for evaluating supply chains are *Delivery Performance* (a), *Order Fulfilment Performance* (b), *Supply Chain Responsiveness* (c), *Production Flexibility* (d), *Total Logistics Management Cost* (e), *Value-Added Employees Productivity* (f), *Warranty Cost* (g), *Cycle Time* (h), *Inventory Days of Supply* (i) and *Asset Turns* (j) (Sürle & Wagner, 2002).



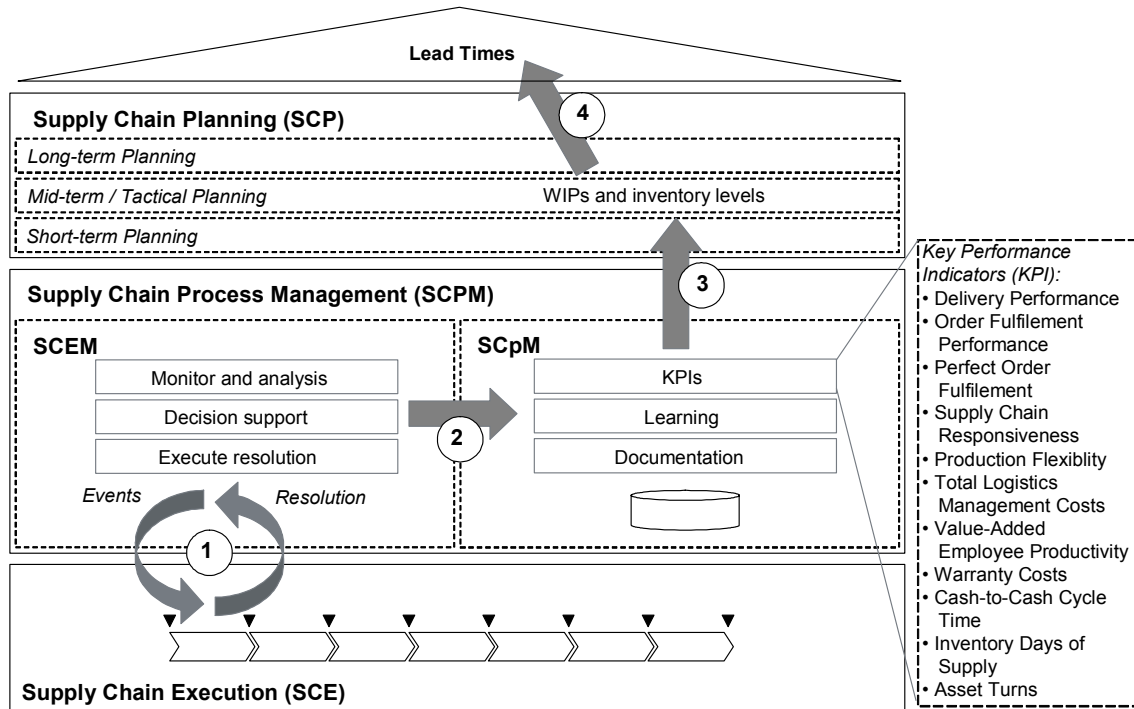


FIGURE 3: Lead time planning cycle

A further measure influencing lead times is the reliability of a workstation (Mirabedini, et al., 2001) or a supply chain partner which should be considered in production planning regarding lead time planning and integrated in mathematical programming models. Such a reliability measure highlights problems of a workstation, e.g., machine breakdowns, maintenance work, problems with setups etc., and accounts for the selection of a workstation for production or whether to prefer a more reliable one. Consequently, it contributes to more consistent and robust production plans at a tactical level, especially in regard of load dependent lead times and its effects also considered in selecting alternative production facilities (workstations or supply chain partners).

As outlined above, the dependency of lead times and workload can be captured by clearing functions whose functional form is reliant on diverse parameters. The basic idea of a clearing function is the expression of resource production in a time period depending on a function of diverse measures of workload as, e.g., WIP and FGI levels and order releases. They can be derived analytically using queuing theory or by fitting them into empirical data which is suggested by (Karmarkar, 1989) or (Asmundsson et al., 2003) who propose the following functional form:

$$(1) \quad f(W) = \frac{K_1 W}{K_2 + W} \quad \text{or} \quad f(W) = K_1 (1 - e^{-K_2 W})$$

Here,  $K_1$  and  $K_2$  are parameters that have to be determined by fitting the functions to data where  $K_1$  represents the maximum capacity of a workstation and  $K_2$  the slope of the clearing function.

To demonstrate the functionality of clearing functions in mathematical programming for production planning, we use a basic structure of a production model. The system is modelled as a network, where the set of nodes  $N = \{1, \dots, j, \dots\}$  represents different workstations or supply chain partners that are connected by a set of directed transportation arcs  $A_t = \{1, \dots, k, \dots\}$  arcs. The final workstation is denoted as  $d \in N$ . Let  $N' = N - d$ . The transportation arcs represent the flow of material between the different partners within the supply chain.

The model is stated as follows:

$$(2) \min z = \sum_{t=1}^T \left[ \sum_{i=1}^M \sum_{j=1}^N (\omega_{jt} W_{ijt} + \pi_{jt} X_{ijt} + \phi_{jt} I_{ijt} + r_{jt} R_{ijt} + \sigma_{jt} S_{ijt} + \delta_{ijt} \gamma_{ijt} \Gamma_{ijt}) + \sum_{a=1}^{N'} \theta_{at} Y_{at} \right]$$

Conservation equations at each workstation:

$$(3) \quad W_{ijt} = W_{ij,t-1} - \frac{1}{2}(X_{ijt} - X_{ij,t-1}) + R_{ijt} + \sum_{\forall a \in A(j,i)} Y_{at} \quad \forall i, j, t$$

$$(4) \quad I_{ijt} = I_{ij,t-1} - \frac{1}{2}(X_{ijt} - X_{ij,t-1}) - D_{ijt} - S_{ijt} - \sum_{\forall a \in B(j,i)} Y_{at} \quad \forall i, j, t$$

State dependent capacity constraint (Clearing Function):

$$(5) \quad X_{jt} \leq f_{jt}(W_{ijt}, W_{ij,t-1}, R_{ijt}) \quad \forall j, t$$

Non-zero initial loading:

$$(6) \quad W_{ijt} = \overline{W}_{ij1} \text{ with } \overline{W}_{ij1} \geq 0$$

Reliability constraint:

$$(7) \quad \sum_{j=1}^{N'} \delta_{ijt} \log(\Gamma_{ijt}) \geq \log(\alpha_{ij}) \quad \text{with } 0 \leq \alpha_{ij} \leq 1, \forall i, t$$

Non-negativity constraint:

$$(8) \quad X_{ijt}, W_{ijt}, Y_{ijt}, I_{ijt}, R_{ijt}, S_{ijt}, \Gamma_{ijt} \geq 0$$

The objective function minimizes the costs of WIP ( $\omega_{ij} W_{ijt}$ ), production ( $\pi_{jt} X_{ijt}$ ), FGI inventory ( $\phi_{jt} I_{ijt}$ ), releases ( $r_{jt} R_{ijt}$ ), shortages ( $\sigma_{jt} S_{ijt}$ ) and transfer to other workstations  $a$  ( $\theta_{at} Y_{ijt}$ ). The conservation equations denote that the WIP of item  $i$  in workstation  $j$  in period  $t$  must equal the WIP from the preceding period minus the average production with  $X_{ijt}$  denoting production over the latter half of period  $t$  and the first half of period  $t+1$ , deduced the raw material releases and the transfer to subsequent workstations. Furthermore, FGI inventory of period  $t$  must equal the FGI inventory of the previous period  $t-1$  minus average production, demand, shortages and transportation to subsequent workstations. The clearing function is given by (5). Equation (6) gives non-zero initial loading; the reliability constraint is presented by equation (7) and (8) gives the usual non-negativity constraint.

The reliability constraint deserves further consideration: the reliability measure  $\Gamma_{ijt}$ , derived by data mining methods from SCQM data based on KPIs, e.g., downtime, setup time (which could vary for specific products), throughput rate etc., must equal or be greater than a predefined threshold  $\alpha_{ij}$  with  $0 \leq \alpha_{ij} \leq 1$  which is a global reliability objective set as the product of all workstation reliabilities:  $\prod_{a \in A(i,j)} \Gamma_{ijt} \geq \alpha_i$ .

Information about the reliability measure can be derived by data-mining methods searching in data warehouse applications of SCQM systems. Furthermore, agent based approaches of SCQM can pass trend information about WIP and FGI inventory levels and, consequently, provide a better data basis for the derivation of clearing functions used in mathematical models.

## CONCLUSIONS

In order to increase global efficiency and responsiveness within supply chains it is increasingly important to ensure the uninterrupted flow of goods and information. A critical success factor is the creation of reliable plans in tactical production planning.

Especially lead times are crucial for global competitiveness, because they impose high costs due to rising WIP inventory levels and larger safety stocks caused by increased uncertainty about production prerequisites and constraints. The concept of SCEM can help to generate the necessary visibility within the supply chain on an operational level. Information derived from SCEM can be used in the short-term to avoid deviations between the planning and the execution. In a long-term view we can collect and analyze this data in a data warehouse for performance improvement of supply chain processes using KPIs. The knowledge about these performance indicators can help us to continuously adjust the clearing functions in mathematical programs for tactical planning. The new type of clearing function can help to improve the reliability of production plans. Our thoughts are described in a mathematical model with an evolved type of clearing function. For the future, the research direction is to analyse the influence of different key performance indicators on clearing functions and the consequences for load dependent lead times.

## REFERENCES

- Andries, B. and L. Gelders (1995). Time-based manufacturing logistics. *Logistics Information Management* 8 (3), 30–36.
- Asmundsson, J., R. Rardin, and R. Uzsoy (2002). Tractable nonlinear capacity models for aggregate production planning. *Working paper*, School of Industrial Engineering, Purdue University, West Lafayette.
- Asmundsson, J., R. Rardin, and R. Uzsoy (2003). An experimental comparison of linear programming models for production planning utilizing fixed lead time and clearing functions. *Working paper*, School of Industrial Engineering, Purdue University, West Lafayette.
- Bretzke, W.-R. (2003). Supply Chain Event Management – Bridging the Gap Between Planning and Realization. Internet Source: [http://www.bbriefings.com/pdf/24/ifpm031\\_t\\_BEAR2.PDF](http://www.bbriefings.com/pdf/24/ifpm031_t_BEAR2.PDF).
- Caramanis, M. and O. Anli (1999). Modeling load-dependent lead time constraints for efficient supply chain coordination: Convexity issues. *Technical report*, Proceedings of the IEEE Conference on Decision and Control, Phoenix, AZ.
- Chen, H., M. Harrison, A. Mandelbaum, A. van Ackere, and L. Wein (1988). Empirical evaluation of a queuing network model for semiconductor wafer fabrication. *Operations Research* 36, 202–215.
- Dauzère-Pèrès, S., Lasserre, J.-B. (2002) On the Importance of Sequencing Decisions in Production Planning and Scheduling, *International Transactions in Operational Research*, 9 (6): 779 – 793
- Fox, M., M. Barbuceanu, and R. Teigen (2000). Agent-oriented supply chain management. *International Journal of Flexible Manufacturing Systems* 12, 165–188.
- Graves, S.C. (1986). A tactical planning model for job shops. *Operations Research* 34, 522–533.
- Gustafsson, J. and A. Norrman (2001). Network managed supply – execution of real time replenishment in supply networks. Technical report, The 6<sup>th</sup> International Symposium on Logistics.
- Huang, K. (2002). Supply chain visibility and event management takes on logistics. Internet Source: <http://transentric.com/article/articlerelease.asp?intArticleID=29>.
- Huddleston, J. (2002) Supply Chain Visibility and Valuation, Internet: <http://www.21stGlobal.net>, Query: 05.04.2005 at 16:12.
- Karmarkar, U.S. (1989) Capacity loading and release planning with work-in-process (WIP) and lead times, *Journal of Manufacturing and Operations Management*, 2, 105-123
- Kauremaa, J., J. Auramo, K. Tanskanen, and M. Kärkkäinen (2004). The use of information technology in supply chains: Transactions and information sharing perspective. Technical report, LRN Conference.
- Kilger, C., K. Ötschmann, and A. Schulz (2005). Anwendungen von Methoden des Supply Chain Managements auf das industrielle Projektgeschäft. Technical report, j&m Management Consulting AG. Internet Source: [http://www.jnm.de/fileadmin/user\\_upload/Dokumente/Artikel/jnm\\_03\\_Paderborner\\_Tagung\\_Methoden\\_des\\_SCM.pdf](http://www.jnm.de/fileadmin/user_upload/Dokumente/Artikel/jnm_03_Paderborner_Tagung_Methoden_des_SCM.pdf)- 3. Sept. 2005.
- Lane, R. (2002). From planning to control: Improving the high-tech supply chain. Technical report, Kleiner Perkins Caufield & Byers. Internet Source: <http://whitepapers.zdnet.co.uk/0,39025945,60028796p-39000532q,00.htm>.
- Lee, H. (2000) Creating Value through Supply Chain Integration, *Supply Chain Management Review*, 30 – 36.

- Liu, E., A. Kumar, and W. van der Aalst (2004). A formal modeling approach for supply chain event management. Technical report, Proceedings of the 10<sup>th</sup> ACM Symposium on Access Control Models and Technologies InternetSource: <http://www.personal.psu.edu/faculty/a/x/axk41/WITS04-camera-SCEN.pdf>.
- Marabotti, D. (2005). Supply chain event management; category, function or just another buzzword? Internet Source: <http://www.silvon.com/resourcectr/wtPaper.php>.
- Mies, A., Voß, S. (2004). The Value of Contemporary Information in the Context of Supply Chain Event Management, in: Li L, Yen KK (eds.), *Proceedings of the Third International Conference on Information, International Information Institute*, Tokyo, 482 – 485.
- Mirabedini, A., S.D'Amours, and D. Ait-Kadi (2001). Tactical planning of reliable supply chain. Internet Source: [http://www.umoncton.ca/cie/conferences/29thconf/29thlCCIE/Papers%5Cpaper 039.pdf](http://www.umoncton.ca/cie/conferences/29thconf/29thlCCIE/Papers%5Cpaper%20039.pdf).
- Missbauer, H. (1998). Bestandsregelung als Basis für eine Neugestaltung von PPS Systemen. *Ph.D.-Thesis*, University of Heidelberg, Heidelberg. Physica Verlag.
- Otto, A. (2003). Supply Chain Event Management: Three Perspectives, *The International Journal of Logistics Management*, 14, Nr. 2, 1 – 13.
- Pahl, J., Voß, S., Woodruff D. L. (2004). Production Planning with Load Dependent Lead Times. *Working Paper*, University of Hamburg.
- Pahl, J., Voß, S., Woodruff D. L. (2005). Load Dependent Lead Times – From Empirical Evidence to Mathematical Modeling in Kotzab H, Seuring S, Reiner G, (eds.) (2005): *Research Methodologies in Supply Chain Management*, Physica, Heidelberg, 540 – 554.
- Sürle, C., Wagner, M. (2002). Supply Chain Analysis. In: Stadtler, H., Kilger, C. (2002). *Supply Chain Management an Advanced Planning – Concepts, Models, Software and Case Studies*. Springer Verlag, 29 – 44.
- Vernon, M. (2004). Ready for anything? Internet Source: <http://www.computerweekly.com/Articles/Article.aspx?liArticleID=200578.html>.
- Voß, S., Woodruff D (2003). Introduction to Computational Optimization Models for Production Planning in a Supply Chain, Springer, Berlin.
- Voß, S., Woodruff D (2004) A model for multi-stage production planning with load dependent lead times. In: R.H. Sprague (ed.) *Proceedings of the 37th Annual Hawaii International Conference on System Sciences*, IEEE, Piscataway, DTVEA03: 1-9
- Zijm, W. (2000). Towards Intelligent Manufacturing Planning and Control Systems, *OR Spektrum*, 22: 313 – 345
- Zimmermann, R. and A. Paschke (2003). Pamas - an agentbased supply chain event management system. Technical report, Americas Conferene on Information Sstems (AMCIS03). Internet Source: <http://ibis.in.tum.de/staff/paschke/docs/PAMAS AMCIS 03.pdf>.
- Zimmermann, R., Winkler, S., Bodendorf, F. (2006). Agent-based Supply Chain Event Management – Concept and Assessment. To appear at Hawai'I International Conference on System Sciences (HICSS).

# MANAGEMENT, FORECASTING AND OPTIMISATION OF ENVIRONMENTAL DATA WITHIN EMISSION TRADING MARKETS: THE ECONOMIC SOLUTIONS: TEMPI AND JET

**Stefan Pickl**

Universität der Bundeswehr München, Germany

The conferences of Rio de Janeiro 1992 and Kyoto 1997 demand for new economic Instruments which focus on environmental protection in both macro and micro economy. An important economic tool in that area is Joint-Implementation (JI) which is defined in Art. 6 of the Kyoto Protocol. It is an international instrument which intends to strengthen international co-operations between enterprises on reducing CO<sub>2</sub>-emissions. A sustainable development can only be guaranteed if the instrument is embedded in an optimal energy management which tries to consider especially the requirements of emergent countries. Special procedures should be developed for that extraordinary case.

## INTRODUCTION

In this contribution we describe two main tools which help to establish such an optimal energy management within emission trading markets: TEMPI and JET.

TEMPI	Technology Emissions Means Process Identification
JET	Joint International Emissions Trading

JET is constructed to assist companies and institutions and addresses the complex process of managing greenhouse gas emissions in a manner consistent with applicable rules and regulations. TEMPI is a forecasting tool to estimate investments in greenhouse gas reduction programs. It uses game-theoretic methods and bargaining procedures. The Protocol calls for strict and detailed accounting and reporting of production of GHG emissions and holdings of emission rights. The protocol includes penalties for procedural mistakes or failures to comply with the requirements of the Protocol. Companies, operating within national registry requirements, must have accurate and up-to-date inventories and tools for tracking, analysing, and reporting the data. In addition, markets are emerging, both regional and national, for trading emission credits as a new commodity, similar to the long-existing markets for emissions of sulphur and nitrogen oxides. Such markets provide economic incentives for a better management of GHG emissions. Tradeable credits are derived from certified reductions recorded over a period of time and must be tracked and properly documented. Thus, a successful trading system calls for accurate and verifiable records of all transactions and data such as serial numbers, transacting entities, account balances, and certification status. Proper underpinning and support for these various interactions and mechanisms require specialized data/information management software that includes a registry system for tracking holdings of metric tonnes of CO<sub>2</sub>e in various protocol-based categories *and* a transaction logging system that records and updates transfers, sales, purchases of CO<sub>2</sub>e that communicates with official registries. At the moment several distinguished registries exist.

In the contribution we introduce actual business solutions as well as the scientific framework of the management, forecasting and optimisation process within emission

trading markets. In the presentation, we refer especially to emerging markets and their role within such economic processes.<sup>1</sup>

## MANAGEMENT OF GREENHOUSE GAS EMISSIONS WITHIN EMERGING MARKETS

The Kyoto Protocol of the UN Framework Convention on Climate Change (UNFCCC) calls for a complex new structure for greenhouse gas management that implies both responsibilities and opportunities for countries, companies, and financial markets (Böhringer, 2003). The standard measurement unit for GHG is the CO<sub>2</sub>equivalent (CO<sub>2</sub>e) metric tonne that takes into account the physical effects of different gases. There are four types of emission units:

- *Assigned Amounts (AAU)*  
National emissions rights for the industrial nations based on targets set by the Protocol for the period 2008-2012
- *Certified Emissions Reduction (CER)*  
Tradeable emission rights originating from Clean Development Mechanism projects in developing nations
- *Emission Reduction Unit (ERU)*  
Emission rights originating from Joint Implementation projects between industrial countries
- *Removal Unit (RMU)*  
Emission rights originating from absorption of GHG in industrial countries (e.g. sinks such as forests)

Achieving the goals of the Kyoto Protocol, or of other regimes for reducing greenhouse gas emissions, will require multidimensional approaches, especially

- *technological*
- *social*
- *economical*

which have a special focus for *emerging markets* and involve complex, long-term, transparent, and verifiable interactions among governments, agencies, and the private sector, (see for example Hansjürgens, 2000 and Hansjürgens, 2003). The Protocol calls for strict and detailed accounting and reporting of production of GHG emissions and holdings of emission rights. The protocol includes penalties for procedural mistakes or failures to comply with the requirements of the Protocol. Companies, operating within national registry requirements, must have accurate and up-to-date inventories and tools for tracking, analysing, and reporting the data. In addition, markets are emerging, both regional and national, for trading emission credits as a new commodity, similar to the long-existing markets for emissions of sulphur and nitrogen oxides. Such markets provide economic incentives for a better management of GHG emissions. Tradeable credits are derived from certified reductions recorded over a period of time and must be tracked and properly documented. Thus, a successful trading system calls for accurate and verifiable records of all transactions and data such as serial numbers, transacting entities, account balances, and certification status. Proper underpinning and support for these various interactions and mechanisms require specialized

---

<sup>1</sup> This overview is a summary of Reed (2001) and Grimm et al. (2006) where VEREGISTER is described in detail.

data/information management software that includes a registry system for tracking holdings of metric tonnes of CO<sub>2</sub>e in various Protocol-based categories *and* a transaction logging system that records and updates transfers, sales, purchases of CO<sub>2</sub>e that communicates with official registries. At the moment several distinguished registries exist; one of them is VEREGISTER (<http://www.vereregister.com>) which was developed by Alan Reed. As described below, Vereregister provides tools for the following purposes:

- *maintain communication between the applications*
- *provide appropriate documentation and reports*
- *meet all United Nations requirements*

In addition, the system contains software for GIS-based geospatial characterization and analysis of GHG sources and sinks, a valuable tool for planning and policy development. The details are described in (Grimm et al., 2006). Optimal energy management according to such processes demand for further analytic tools.

### **OPTIMAL ENERGY MANAGEMENT AND EMERGING MARKETS**

There are only a few approaches which try to simulate and forecast investments in the field of emission trading markets. In the following we want to describe the analytic tool TEMPI (Technology Emissions Means Process Identification) and a possible combination of TEMPI to JET (Joint International Emissions Trading).

TEMPI bases on the so-called TEM model (Technology-Emissions-Means model) which was developed by (Pickl, 1998a), providing the opportunity to simulate such an economic behaviour. It is a model in the field of economathematic models which integrates economic and technical investments in a coupled time-discrete nonlinear system of equations. The Framework Convention on Climate Change (FCCC) demands for reductions in greenhouse gas emissions by the industrialized countries. On the other hand, developing countries are expanding their energy consumption, which leads to increased levels of greenhouse gas emissions. The preparation of an optimal management tool in that field requires the possibility to identify, assess, compare and forecast several technological options. For that reason, TEMPI (Technology Emissions Means Process Identification) was developed as a comfortable software. TEMPI bases on the TEM model which will be explained in the following. According to the FCCC (Article 4, paragraph 2(a)), additional control parameters are incorporated which have to be determined iteratively, according to a game theoretic negotiation process. The iterative solution to the nonlinear time-discrete TEM model is an approach to initiate cooperative behaviour in the realization of joint CO<sub>2</sub>-reduction initiatives and programs. The cooperative aspect comes more and more in the centre of interest. (Hansjürgens, 2003) gives a very good overview about this field.

TEMPI offers several possibilities within an emissions data management:

- *Documentation for the user*
- *Interactive learning system for the user*
- *Data bank access via the internet (ORACLE)*

The TEM model can be expanded to model Emission Trading Markets.



**FIGURE 3: TEMPI-Analytic instrument to simulate greenhouse gas emissions and investments**

### **EXTENSION OF THE TEM MODEL TO EMISSION TRADING MARKET-PROTECTED AUCTIONING PROCEDURES AND ALGORITHMS (PAPA)**

Reductions in emissions will produce units to be traded. So, the focus is on both to reduce GHG and to establish information management that will provide the necessary administrative framework of the reductions that serve as the instruments for gaining wealth in the marketplace. Even at this elementary stage of the system, it is clear that the 21<sup>st</sup> Century will be characterized by the creation of billions of dollars worth of new tradeable certificates, representing not a share of a producing entity, but rather a number of metric tonnes of an ephemeral byproduct of modern industry, tonnes which no longer exist. With so much at stake, the emissions trading market will rely on the institution of new means for originating information about the output of GHG emissions and the location, control, and ownership of those emissions. The TEM model should be enlarged in the following direction:

- *How can a joined international emission trading process be described?*
- *How can the determined goals be reached with such a process?*
- *How can the special profile of emerging markets be considered?*

The presentation gives first answers to these actual problems. Mathematical solutions are as well presented as a first software prototype TEMPII. We will focus on a new cooperative approach which tries to consider the relationship between industrialized countries and emergent countries. Additionally to Grimm et al. 2006, details of stability and “protected auctioning procedures and algorithms (PAPA)” should be considered and presented.



**REFERENCE**

- Bültmann, A.; Hansjürgens, B. 2002. „Umweltpolitik und Umweltmanagementsysteme“, Zabel, H.-U. (Hrsg.) *Betriebliches Umweltmanagement – nachhaltig und interdisziplinär*, S. 195-210.
- Gagelmann, F. and Hansjürgens, B. 2002. „Der neue CO<sub>2</sub>-Emissionshandel in der EU“, *Wirtschaftsdienst. Zeitschrift für Wirtschaftspolitik*, Jg., H. 4, S. 226-234.
- Grimm, B. 2003 „Wandel durch Handel, Umweltschutz nach Angebot und Nachfrage“, *TÜV Journal, 1.Quartal 2003*
- Grimm, B.; Pickl, S. and Reed, A. 2006 “Management and Optimization of Environmental Data within Emission Trading Markets, VEREGISTER AND TEMPI,” in:  
*B. Hansjürgens, P.Letmathe (Hrsg.) “Business and Emissions Trading”, Physica Verlag*
- Hansjürgens, B.; Köck, W. 2003. „Kooperative Umweltpolitik – eine Einführung“, erscheint in: Hansjürgens (Hrsg.): *Kooperative Umweltpolitik*, Baden-Baden.
- Hansjürgens, B.; Lübbe-Wolff, G. 2000. *Symbolische Umweltpolitik*, Frankfurt (Verlag Suhrkamp), 318 S.
- Kyoto-Contract. 1997. see: <http://www.unfccc.org/resource/convkp.html>
- Löschel, A. 2001. “Technological Change in Economic Models of Environmental Policy - A Survey”. *Ecological Economics* 43 (2-3), 105-126.
- Meyer-Nieberg, S. and Pickl, S. 2003. “Simulation eines CO<sub>2</sub>-Zertifikatenhandels und algorithmische Optimierung von Investitionen“. *Operations Research Proceedings 2002 (Selected Papers)* 471-474. Berlin, Heidelberg: Springer Verlag.
- Pickl, S. 1998a. *Der  $\tau$ -value als Kontrollparameter - Modellierung und Analyse eines Joint-Implementation Programmes mithilfe der dynamischen kooperativen Spieltheorie und der diskreten Optimierung*. Aachen, Shaker Verlag.
- Pickl, S. 1998b. “Implementation and verification of a Joint-Implementation program”. 62. Physikertagung der Deutschen Physikalischen Gesellschaft Regensburg 1998, *DPG - Deutsche Physikalische Gesellschaft. Proceedings*, 168-174.
- Pickl, S. 2001. “Optimization of the TEM Model - co-funding and joint international emissions trading”. *Operations Research Proceedings 2000 (Selected Papers)* 113-118. Berlin, Heidelberg: Springer Verlag.
- Pickl, S. 2002. “Investitionsoptimierung mithilfe von TEMPI“. W. Fichtner, J. Geldermann (Hrsg.) *Einsatz von OR-Verfahren zur techno-ökonomischen Analyse von Produktionssystemen*. Peter Lang. Frankfurt am Main, 95-109.
- Stronzik, M. and Bräuer, W. 2001. “Accreditation, Verification & Monitoring of Joint Implementation”. *JOINT Working Group 4 Position Paper*, Mannheim.
- Reed, A. 2001. “Delivering Data”. *Environmental Finance*, No. 9  
VEREGISTER <http://www.veregister.com>



# INTEGRATION OF SMALL AND MEDIUM ENTERPRISES FOR BETTER RESOURCES MANAGEMENT CONSIDERING THE ENVIRONMENT

Toshko Zhelev, Bernadette O'Regan, Richard Moles  
Center for Environmental Studies  
University of Limerick, Limerick, Ireland

Presented paper focuses on the selection of appropriate process integration methodologies and their tuning for integrated management of resources in a cluster of small and medium enterprises (SME) allocated in close proximity. Proposed integration aims the improvement of industrial efficiency with strong emphasis on the environmental impact. The process systems engineering approach possesses an arsenal of weaponry suitable for creative implementation in the area of small and large size systems, their integration and optimisation. Four major methodologies are proposed for direct implementation: The first one explores the concept of *integration between areas of integrity*; the second utilises the *marginal value* concept; the third one attempts to amalgamate two successful systems integration tools such as Pinch analysis and eMergy analysis entering the domain of multiple resources management, and the four one addresses the energy minimisation of activated sludge water treatment plants as centralised eco-service helping decision making towards on-site treatment. The paper reports the progress of an on going project supported by the Environment Protection Agency of Ireland. It discusses challenges related to the integration, resources management and environmentally benign operation of urban based SMEs forming clusters of mutual trust and benefits known as Eco-industrial network.

## INTRODUCTION

During the last 20 years in Europe appeared a new type of industrial sites replacing the large scale operations – the industrial estates where large number of small and medium enterprises (SMEs) find convenient allocation close to the market and the work power. At first sight, this new conglomerate of different and randomly mushrooming activities seems to be quite independent and indifferent. Despite of the facts that an industrial estate can include wide range of industrial activities, there are factors of common ground that justify the specification of a system. Such is the common ground of allocation, the common environmental constraints, the energy supply, sewage and other components of common infrastructure (roads, phone, communication, etc.). Shortly, it is a new type of system that needs to be studied, analysed and transferred to more efficiently leaving organism for the benefit of the society. The main goal of such a study would be the maximisation of the mutual benefits derived from the close proximity of enterprises' location and the common environmental concerns that need to be addressed in a systematic manner.<sup>0</sup>

The process systems engineering principles can be seen in accordance with the principles of sustainable development and industrial ecology; especially, when the definition "site" is extended to include the environment and the society.

In our case the intention is to utilise the concept of integrating areas, sites and industrial activities of particular integrity with the view of better and more efficient performance accompanied with more environmentally friendly operation that is recognised by the local society. The core fundament of such an integration remains at the systematic approach to energy and material flows, where the effluent's flows and waste management becomes a whole new dimension of it.

## **ECO-INDUSTRIAL NETWORK**

The drive for integration leading to possible economic and environmental benefits has turned our focus onto local small and medium enterprises (SMEs) allocated in the proximity of the Mid-West region of Ireland. The Mid-West region of Ireland is formed by three counties (County Limerick, County Clare and County Tipperary). It includes approximately 10% of the national land area and the population of Ireland. The industrial base is dominated by light industry such as electronics, instruments, pharmaceutical and healthcare, metals and engineering. The attractiveness of the Mid-West as a location for industry is demonstrated by the large number of foreign-owned plants established in the region. It is estimated that there are approximately 400 SMEs in the Mid West region.

While SMEs contribute to growth, employment and rural development they also exert quite significant impacts on the environment. It is estimated that in total SMEs are responsible for 70% of all industrial pollution across the EU (EC Enterprise Directorate General, 2004).

The announcement of our research in the area of industrial integration has attracted significant interest in the region and already 25 SMEs from the Mid West region formally expressed commitment to this project. Many of these companies already work together in areas other than sustainability and this basis has established such crucial advantages as mutual trust.

There are many successful international examples of SMEs integration to form Eco-Industrial networks and these have been successful in terms of the reduction of environmental impacts. e.g. waste reduction, resource use reduction, improved transport management, etc. and improved competitiveness for the companies involved. Such are: Kalundborg - Denmark and Styra - Austria; the INES project in Rotterdam Harbour and the UK National Industrial Symbiosis Programme (<http://firstsupply.co.uk/nisp/>). But there is still to be done in terms of integration methodology development and methodology generalisation.

## **THE CONCEPT**

Eco-Industrial development is characterised by closely co-operating manufacturing and service industries working together to improve their environmental and socio-economic performance by improving their energy resource use and waste disposal efficiency through identification of options for reuse, recycling or regenerative reuse of resources across areas of integrity. This may be as simple as identifying a waste from one factory which could be used as a raw material by another business, or as complex as rethinking the transport and supply logistics for the entire cluster or maximising economic and environmental performance using grass-root multi-objective optimisation methodology.

The attraction in the concept of Eco-Industrial development lies in its application of the natural ecosystem metaphor to "industrial ecosystems". The ideal of the metaphor is that industrial ecosystems function according to the system development principles of natural ecosystems, i.e. closed loops and waste utilisation between industrial actors (Singhal & Kapur, 2002). A local or regional industrial system is encouraged to move towards an interactive system through cooperative waste material and waste energy utilisation (recycling of matter, cascading of energy) and sustainable use of local renewable natural resources of matter and energy between the industrial actors. By reducing the waste management costs, emission control costs, raw material and energy costs, transportation costs, costs resulting from the implementation of measures

required in environmental legislation and by improving the environmental image as well as the “green market situation” of the network, economic gains are possible.

The goal of Eco-Industrial development is, at the minimum, to generate the least damage in industrial and ecological systems through the optimal circulation of materials and energy (Cohen-Rosenthal, 2004).

### **SYSTEM ORIENTED METHODS**

They provide practical way to find required minimums of energy, raw material and water at a system level. Unfortunately by now the developed methods consider separately each of the resources in question.

The information available for the process design alters during the process life cycle stages because of process development, design, operation and retrofit. In the case of existing network of companies this increases the level of complexity. Therefore to guide the decision maker towards the total optimum, a more complex view on the analysis of process integration efficiency is required.

In the beginning of the project the process design activities are first aligned with the strategic targets of the company. To allow this, the company management has to define strategic goals and priorities for the design/redesign/operation. At the same time, this information will sharpen many design constraints.

### **AREAS OF INTEGRITY**

An energy integration concept developed by (Ahmad and Hui, 2001) may have an important impact to the undertaken task of beneficial integration within the Eco-Industrial Network. The concept utilises the natural division of process plants in logically identifiable regions (areas of integrity) and the potential for heat (energy) recovery between these areas. The optimisation task in this case is formulated as identification of schemes of energy recovery between areas of integrity which offer maximum heat flow between these areas (maximum integrity) that secures minimum energy import to the system with least number of interconnections between the regions. Authors propose procedure which translated the heat flow schemes into actual heat exchanger network design.

Proposed methodology generates solutions ensuring maximum energy recovery between areas of integrity with minimum capital investments. This concept can be adapted without changes for the purposes of energy conservation within an Eco-Industrial Network. The areas of integrity in this case are the SMEs themselves and the integration of energy will be done with minimum re-piping or other type of interconnections between them.

### **MARGINAL VALUE ANALYSIS FOR MULTI-SITE APPLICATION**

The idea of the method is to evaluate the real value of utilities, such as steam, water, etc., and all other process streams, which in the general case have different value when different production sites are concerned. This allows more transparent and convincing background for decision-making when the integration of energy and other resources between neighbouring industrial partners is an option. As shown by (Hui, 2000), marginal values are strongly affected by the location of site-wide bottlenecks well as external economical conditions such as fuel and product prices.

How to calculate the marginal value of a utility, for instance, one has to trace its corresponding production path. To define the marginal value of any stream, (Hui, 2005), proposes the evaluation of three marginal values, which substitute difficult process of tracing the material's production path. Those are the marginal profit, the produc-

tion cost and the production value. The calculation of these three values can be done using so-called site model, which consists from material and energy balances and topology (structure) of the system in question. There is some idea how to calculate these values:

**Marginal profit (MP) =  $\Delta\text{Profit}/\Delta\text{Change of stream flow}$**

**Marginal cost as feed (MC<sub>F</sub>) =  $\Delta\text{Profit}/\Delta\text{Feed to process stream}$**

(indicates the profit made increasing the yield)

**Marginal value (MC<sub>P</sub>) =  $-\Delta\text{Profit}/\Delta\text{Product from a process stream}$**

(normally shows the production cost of the stream)

We propose a new use of marginal values for integration decision-making and multi-site application. An important side of this analysis is the creation of an integrated site model. The proposed analysis in general case will include marginal values of utilities, services, inventories, transport, IT, treatment, etc. The final purpose of the analysis is the evaluation of eventual changes of marginal values as a result of proposed integration.

## EMERGY ANALYSIS FOR INTEGRATION

To address the levels of integration and the sustainability level a logical question arises – is there a way to address and analyse the vast majority of resources and goods, but what about the services, treatment and operations involving these resources? It is known from quite some time that the *emergy* is providing resources for such combination.

The available solar energy used up directly or indirectly to make a service or product available, defined as *emergy* by (Odum, 1996), was applied by number of authors to compare inputs of different origin, such as human labour, trucks, energy, fuels, chemicals, utilities, plant cost, etc. Solar *emergy* is the solar energy directly or indirectly necessary to obtain a product or a flux of energy in a process; it is an extensive quantity and its unit is the solar *emergy* joule [sej]. To convert inputs and other kind of flows into the solar equivalent, it is necessary to know the solar transformity, which is the *emergy* necessary to obtain one unit of product. Unlike the *emergy*, transformity is an intensive quantity and usually measured in [sej/J]. Transformity calculation is a difficult task stimulating researchers to exchange data and build databases establishing common ground for analysis.

An interesting feature of *Emergy* analysis is that it gives historical information about the resource or activity in question. Any *emergy* in the particular moment of interest contains all *emergies* of stages changes occurring on the way to that stage. The *emergy* value associated with a product is the memory (the sum) of the all *emergies* that were used to produce it. Another grate feature of *emergy* analysis is the ability of identification of critical processes/stages/units. This makes it quite suitable for the purposes of environmental pre- and post-impact consideration in the Eco-Industrial Network.

In 2003 (Zhelev et al., 2003) promoted the interesting idea of combining *emergy* analysis with Pinch analysis – a well known tool for resources management in industry. These two methods give the missing link between the industrial resources management for economic benefits and the environmental impact assessment comparing alternative solutions. The restriction in the particular case is that the combined analysis addresses energy resource only.

## EMERGY-PINCH ANALYSIS

As suggested earlier by (Zhelev & Ridolfi, 2003) the amalgamation between Emergy and Pinch concepts can lead to number of benefits. Details about technicalities of the combined procedure are given again there. As it can be expected, to apply Pinch concept one needs to construct the Composite curve and draw the targeting line. The streams, being either wastewater or energy, are defined in emergy units and in the way that can support emergy composite construction for the purpose of further targeting. Each stream is represented in a specific way. There is a portion of information (transformity) describing the past emergy investment, the “history” of the stream; a second portion, showing the “market” potential of the stream in terms of usability, as it is the heat (temperature) potential for a thermal stream or the concentration limits, if it is a water stream; the final, third portion of information is associated with the stream’s future – it is linked to the future of the stream and its further usability (regenerative reuse). In the case of thermal Pinch analysis, the hot and cold streams will have different sign of this component of final emergy investment. The required emergy investment to heat the cold streams will possess different sign than the available emergy, allowing at this level of analysis to relax particular constrains such as  $\Delta T_{min}$  that can lead to minimisation of the usage of expensive hot utility.

As it is mentioned by emergy analysis seldom addresses industrial systems and do not consider the impact of wastes - that third portion of information we impose to the stream definition. Important issue is the possibility in the third portion (stage) of any resource stream to consider waste reuse option (partial positive emergy, associated with it and another portion that is to be lost when disposed to the environment. The same authors considered waste treatment (regeneration) and reuse in the emergy indexes used for emergy analysis. The emergy loss is considered through the investment in waste treatment. At the same time this treatment may not only recover ecologically acceptable level of the resource, but also raise its potential for regenerative reuse.

Applying the Pinch analogy, the projection of any stream-representing vector on X-axis shows the Solar Emergy, the projection on Y-axis gives the solar transformity. The solar transformity is a quality characteristic. The slope (reverse of the slope) of the line represents the amount/flowrate, quantity of the resource. It should be noted that the solar emergy has a relative (not absolute) value, so the allocation of the line representing a resource would be not fixed in horizontal plane.

In the general case of emergy analysis similar to classical Pinch analysis the processes “overlap” in the horizontal plane (temperature range, concentration range, here - transformities range). The emergy loads, or investments, for different processes are characterized by relative values. Then their graphical representation can be freely shifted left and right in their SolarTransformity/SolarEmergy plot.

### Targeting

The total emergy investment would be targeted drawing the line touching the composite and accounting for its slope. As bigger the slope of total emergy investment line is as smaller the rate of total emergy investment. This means the supply of combined resource and corresponding costs associated with it will be minimised lifting the emergy supply line to its maximum. The limit is manifested by the touching point between the supply line and the composite curve, the point known as Pinch. Measuring the allocation of the emergy supply line and its slope can help to compare alternative design or operation options. In other words, transformity is accepted as a parameter involving quality and plotted against the emergy investment allows targeting of total emergy investment and determination of maximum total transformity need to run the process.

### **Design Guidelines**

The treatment and reuse of wastes is the key to the evaluation of systems sustainability. The energy loss is considered through the investment of waste treatment, but in the same time this treatment may not only recover ecological acceptable level of the resource, but raise its potential for regenerated usage (application).

The Pinch concept is also giving unequivocal design guidelines helping to design a system fulfilling the earlier defined targets. The design guidelines will come from classical pinch grid diagram. The energy composite will identify potential processes to be changed before fixing temperatures and flowrate of streams. The design issue of combined energy-pinch analysis is of special importance and complications that needed special attention. The design guidelines will come from classical pinch grid diagram. The energy composite will identify potential processes to be changed before fixing temperatures and flowrate of streams. A single energy composite is drawn for all streams and an energy investment supply line is matched accordingly. Such an analysis would show the targets in terms of energy investment.

An interesting point for discussion is if one can consider processes generating Energy, not only those consuming Energy. For example these can be any exothermic reaction, water generation as a result of chemical reaction, money generated through sale, power co-generation, etc. In such a case it might be better to consider first the optimal utilization of internal resources of energy and then – the minimization of the external ones.

The design guidelines suggested by this approach are associated with the classical concept of Grid diagram. The Energy composite helps to identify potential processes to be changed before fixing temperatures and flowrate of process streams. A single energy composite is drawn for all streams and an energy investment supply line is matched accordingly. Such an analysis will show the targets in terms of energy investment.

### **Bottlenecks Identification**

The identification of bottlenecks is of great concern in all methods of analysis and evaluation. The Pinch does it through its third graphical tool – the Grid diagram. It shows the cross-pinch energy transfer leading to cost implications and penalties. The energy analysis identifies the critical processes through the value of energy investment. Combining Energy and Pinch concepts we are able to identify more precisely the combined influence of critical processes or phases through allocation of constrained processes (these touching the total energy investment supply line and preventing its further lift up). The Pinch-type of targeting gives several important evaluation parameters: (1) the ultimate minimum energy supply to run the entire process at any time (the slope of the total energy investment). This is the flow of resources, services and work to run the entire system); (2) The total energy investment for the entire process for the entire period; (3) The maximum transformity (the “amplitude” of transformity, giving the total “power” of resources to run the process – another criteria to compare alternatives, identifying what process needs resources of highest quality) – the horizontal projection of the right end point of the energy investment supply line; (4) Limiting stages/resources (restricting the energy investment supply line to increase its slope). This one gives indication about processes and resources which utilisation is to be intensified in order to improve the efficiency of the entire process; (5) Pinch point allocation; there is some substantial difference in the possibilities for improvement (minimisation) of the total energy supply for Pinch points allocations characterised with lower trans-



formity compare to those with high transformity. Details of these cases can be found in (Zhelev and Ridolfi, 2003).

### **OXYGEN-WATER PINCH ANALYSIS**

As Thermal Pinch Analysis addresses heat exchange from a hot stream to a cold stream, so does the Water Pinch Analysis addressing mass exchange from a rich stream to a lean stream. A rich stream is a stream that has higher concentration of contaminant while a lean stream has lower concentration of the contaminant. The initial methodology (El-Halwagi and Manousiouthakis, 1989) considered the transfer of only a single contaminant from a rich stream to a lean stream. The method is analogous to Thermal Pinch Analysis and uses the same basic steps. Wastewater may be minimised using any of the following redesign methods (Wang and Smith, 1994):

- *Reduction in Fresh Water Used.*

A reduction in the water supply will result in a decrease of the quantity of wastewater being produced. Optimising processes may change the fresh water demand for the process.

- *Reuse of process water*

Certain process streams require water of any quality, such as in the case of floor washing processes. The water supplied for these processes needs not be fresh water. Thus there is an opportunity to reuse water. The opportunity can be found in the neighbour factory. The benefit of water reuse has to be assessed accounting for the piping and pumping costs.

- *Regeneration recycling*

Water that leaves a process is often termed as wastewater. The quality of this water determines whether this water may be reused in other processes or neighbour factory. If the wastewater from a process can be treated easily and at a low cost, then the water may be “cleaned” or regenerated and used again. Simple regeneration can be settling or filtration.

- *Regeneration and reuse*

The water that is regenerated may be used in another process or factory and need not be recycled to the process/factory it originated from.

- *Oxygen Pinch Analysis*

The intent to design more cost attractive wastewater treatment systems was approached by extending Pinch principles towards so-called Oxygen Pinch analysis (Zhelev and Ntlhakana, 1999). The idea is to target prior to design the idealistic minimum oxygen required by the micro-organisms to degrade organic waste and to suggest treatment flowsheet and design changes ensuring efficiency of operation close to the earlier stated target. In most of the cases the oxygen is supplied to the micro-organisms through agitation. Agitation and other forms of aeration require energy, so finally the analysis based on Oxygen Pinch principles leads again to their original application associated with energy conservation. Apart from this, Oxygen-Pinch concept allows for the first time targeting a quality characteristic – the growth (the reproduction rate, or heath) of micro-organisms.

- *Combined Water-Oxygen Pinch Analysis*

The aim of this methodology is to help decision making about the strategy and the organisation of wastewater treatment within an Eco-Industrial Network. Major factors contributing to the cost of wastewater treatment and pollution levels are the wastewater quantity and the wastewater quality. The wastewater quantity is directly linked to the amount of energy required for the wastewater treatment. The objective to minimise the wastewater quantity can be achieved using the Water-pinch analysis. Water Pinch

helps to increase concentration levels of wastewater and decrease its quantity. In contrary, wastewater quality is inversely proportional to the energy required for wastewater treatment as well as pollution levels. There is no integration technique that would facilitate wastewater quality improvement. A mechanism to negate this effect is required. This objective can be achieved by the application of Oxygen Pinch Analysis. Thus the overall effect of increasing the cost effectiveness of wastewater treatment can be addressed through combination of Water and Oxygen Pinch Analysis. The expected result is a decision-making procedure suggesting within particular market circumstances what amount of wastewater to be taken for treatment within particular member factory of the Eco-Industrial network and what part of it to be sent to the servicing wastewater treatment plant.

- *Combined Methodology*

The link between Water Pinch Analysis and Oxygen Pinch Analysis is the common concentration variable, namely - the Chemical Oxygen Demand (COD). This concentration variable is duplicated in Oxygen Pinch Analysis as COD of the wastewater. The link between these two Pinch techniques, is the usage of COD as a single concentration variable. To demonstrate this amalgamation two configurations of wastewater treatment can be investigated – one based on centralised wastewater treatment strategy and second – using the strategy of the distributed wastewater treatment. The quantity of wastewater treated and the quantity of oxygen required are chosen as variables of the analysis of the most suitable wastewater treatment strategy. The quantity of wastewater can be minimised on particular factory site using the Water-Pinch concept. The quantity of oxygen required (respective the aeration energy required) for different quantities and qualities of wastewater can be targeted with the help of Oxygen-pinch concept. Both, the quantity and the quality of the wastewater treated are related to the cost of the treatment process. The configuration of wastewater treatment serves as an aid to establish whether there was a significant difference in wastewater treatment cost when the service charge is based on quality rather than on quantity only.

The above methodology may very well serve particular Eco-Industrial network as a convincing argument for or against the idea for commissioning of a centralised wastewater treatment plant, its allocation, etc. It can help particular member factory's decision to join the group of factories served by such a plant as well as the cost-effective quality and quantity of wastewater to be sent to this servicing plant under particular market circumstances. It can serve as a firm ground for targeting the minimum electrical energy (respective cost) for treatment of different quantities and qualities wastewater – a tool for determination of servicing charges.

## **WATER PINCH AND EMERGY**

Water Pinch principles have established a standard for drawing the limits for water reuse in industries and setting pre-design targets of minimum fresh water demand - an important feature for addressing alternative solutions of design changes and production expansion. One important feature of Water Pinch, inherited from the classical Pinch analysis is that this method apart from the preliminary targets setting gives design guidelines - an important advantage comparing it to Emergy analysis. Water Pinch considers mainly streams' contamination level, what in the general case is not enough. It is more than obvious that different contaminations and concentration levels would need different effort of water treatment depending on the nature of contamination, composition, chemical bounds, etc., not only concentration levels and limits. Here comes the help of Emergy analysis. The ability to assess the history and the effort associated with

making water resource available (boring dept, pumping, pre-treatment (softening, filtration, chlorinating, etc.)) provides good ground to compare resource of equal quality.

The confidence to use transformity as an analogue to the temperature in thermal Pinch analysis or concentration in water Pinch targeting comes from the fact that the transformity is an intensive unit of emergy and measures the quality of energy. The emergy of the wastewater may be determined from the knowledge of the concentration and nature of the effluent, and the transformity of the relevant ecological services (water treatment process). Considering that the water is not the first priority asset in Ireland, the Water-Emergy Pinch analysis is to be used for decision making in the constrained cases of plant expansion, when the water resources are limiting the expansion decision.

### **INTEGRATION WITHIN THE ECO-INDUSTRIAL-NETWORK**

The first level of analysis focuses on the possible on-site integration of processes inside the factories in question. This time consuming process is based on iterative evaluation of data collected through detailed questionnaire, interviews of staff in question and design documentation. Currently we collected data from 8 out of 25 member factories. We constrained the possible integration into four different vertical levels: (a) energy; (b) water; (c) waste treatment; (d) transportation. With the help of geographic data management system we first considered the possibility of horizontal integration between areas of integrity. First, decomposition in clusters of member SMS was proposed accounting for their geographic allocation. Second level of decomposition was based on common landfill waste-disposal sites. The third level of decomposition accounted for potentials of inter-factories waste-reuse/waste and utilities utilisation options. The optimisation problem of maximum cost benefit can be formulated as a problem of finding the maximum of the “vertical sum” of “horizontal integration benefits”. The proposed principle for redistribution of the achieved savings amongst the member enterprises was proportionality to the integration investments.

### **OTHER INTEGRATION ACTIVITIES (FUTURE WORK)**

These may include investigating possibility for integration of not only energy, water and waste recovery, but possible sharing of information and information technology investments. The diffusion of information and communication technologies (ICT) offers opportunities to transfer, collect and manage a great amount of information and to reduce the space and time barriers. Participating firms may reduce their ICT costs by forming a joint Management Information System (intranet) for the Cluster and this will identify further opportunities for sharing information and resources.

Next level of integration expansion can be common purchase of materials and shared transportation, shared commuting, shared inventories, shared shipping through integrating the transportation logistics of the participating SMEs. Each of these provides for a reduction in environmental impacts through reduced fuel cost, transport related emissions while also reducing the transportation costs of the companies and providing additional social benefits in reducing the number of vehicles on the roads.

At present we work on the problems of integration when system’s dynamics is considered. The case study is based on wastewater treatment system at Killarney, where the number of citizens served is raising eight times during the summer period.

### **CONCLUSION**

Adopting the principles of Eco-Industrial networks, this paper builds a set of appropriate methodologies and develops procedure suitable to identify synergies and opportunities for symbioses between collaborating SMEs which would result in enhancing

the environmental performance of the companies, targeting opportunities for socio-economic benefits. The paper reports progress in tailoring and application of four integration concepts originally developed for smaller and more compact systems to larger systems, such as the Eco-Industrial Network of factories, situated in restricted geographic region. The major difference to other well-configured systems is the principle of open-side system integration. That means – the system is to allow provision for flexibility (including or excluding neighbor factories) and include other integration dimensions. The four methodologies in question are: (a) Energy integration of distant areas of process-supported integrity; (b) Marginal value analysis; (c) Emergy-Pinch analysis (a novel amalgamation of two conceptual design approaches), and (d) Oxygen-Water Pinch analysis. These four integration methodologies are designed to consider the economic and environmental impact to decision making. The idea behind the integration of these methodologies is the merge between sustainability concerns at regional level with environmental concerns first at process level and second at SME level (horizontal and vertical integration).

We hope that the effort invested in this on-going project can demonstrate the practicality of the proposed framework with a view to create a platform for eventual set up of strongly integrated Industrial Ecology Park.

#### ACKNOWLEDGEMENT

This project is being undertaken as part of the Irish EPA's research programme entitled the Environmental Research, Technological Development and Innovation Programme 2000-2006. The programme is financed by the Irish Government under the National Development Plan.

#### REFERENCES

- Ahmad, S. and DCW Hui, 2001. "Heat recovery between areas of integrity", *Comput & Chem.Eng.*, 15(12): 809-832.
- Cohen-Rosenthal, E., 2004. "Making sense out of industrial ecology: a framework for analysis and action", *Journal of Cleaner Production*, In Press.
- EC Enterprise Directorate General, January 2004. "Public Policy Initiatives to Promote the Uptake of Environmental Management Systems in SMEs", Final Report Expert Group, EU.
- El-Halwagi, M.M. and V. Manousiouthakis, 1989. "Synthesis of Mass-Exchange Networks", *AIChE Journal*, 35 (8): 1233.
- Hui, C.W., 2000. "Determine Marginal Values of Intermediate Material and Utility using a Site Model", *Comput. & Chem Eng.*, 24:1023-1029.
- Odum H.T., 1996. "Environmental Accounting: Emergy and Environmental Decision Making", John Wiley and Sons, New York.
- Singhal, S., Amit Kapur, 2002. "Industrial estate planning and management in India—an integrated approach towards industrial ecology", *Journal of Environmental Management*, 66(1): 19-29.
- UK National Industrial Symbiosis Programme (<http://firstsupply.co.uk/nisp/>)
- Wang, Y.P. and R. Smith, 1994. "Wastewater minimisation", *Chem Eng Sci*, 49(7):981-1006.
- Zhelev T.K. and L. Ntlhakana, 1999. "Energy-Environmental Closed-Loop through Oxygen Pinch", *Comput. & Chem.Eng.*, 23: s79-83.
- Zhelev, T.K., R. Ridolfi and N. Marchettini, 2003. "Combined Pinch-Emergy Assessment for Integrated Waste Management", *Chemical Engineering Transaction*, 1: 691-696.

# ANALYSIS OF ENERGY FLOWS BY USING PINCH ANALYSIS

**Peter Radgen**

Fraunhofer ISI, Karlsruhe, Germany

The principles of Pinch Technology which are stemming from thermodynamics have changed dramatically the design process of industrial heat using plants. At the time when Pinch Analysis gained attention in the early eighties, brute force computing using MINLP algorithms to identify the most economic heat exchanger network for the multiple use of energy in a plant was not possible for even small scale problems.

Therefore it was important to reduce the number of possibilities to be evaluated by using the first and second law of thermodynamics in an effective manner. The main elements developed, which have given the name to the Pinch Analysis, are the composite curves (CC) and the grand composite curve together with the Pinch Design Rules to achieve minimum heating and cooling demand for a given minimum temperature difference. Pinch Analysis made its way into the design process very quickly. A major advantage of Pinch Technology against black box process optimisation is the gained understanding of the process heat flows. The Pinch design rules can be easily applied and lead often to new ideas for changing process condition to enable for an increased heat recovery. As an example, results of a Pinch Analysis of a fertilizer process are presented.

## INTRODUCTION

Energy costs represent a considerable proportion of manufacturing costs in the process industry. Optimisation of energy consumption together with supply and removal of energy is therefore an important task. Rapidly rising oil prices in the years 1973 and 1979 supported the research for systematic methods for the optimisation of process performance. With high energy prices in the recent year, energy savings have come back to the agenda of industrial managers.

Pinch Technology provides a systematic methodology to identify energy savings in processes and total sites. The methodology is based on thermodynamic principles (Linnhoff, 1979). To start with a Pinch analysis the heat and material balance for the process is determined. The process understanding gained by using Pinch analysis can be used to identify appropriate changes in the core process conditions that can have an impact on energy savings. In addition energy saving targets can be set prior to the design of the required heat exchanger network. The Pinch analysis finally supports the design of the heat exchanger network and the utility selection to ensure that these targets are achieved. The method is not limited to single processes but instead helps to integrate heat flows of total sites via the utility system.

## USING MINLP FOR THE DESIGN OF HEAT EXCHANGER NETWORKS

During the early eighties computing capacity was a scarce and expensive resource, therefore the number of different heat exchanger networks that could be constructed to obtain the most economic heat recovery solution was rather limited (Ciric, 1986). Based on the stream data of hot and cold streams a super structure containing all possible heat exchangers had to be developed. This Superstructure had then to be optimised as a mixed integer non linear programming problem, where the integer values standing for a heat exchanger to be placed and the non linear parts to calculate the properties of the streams entering or leaving the heat exchanger as well as the heat exchange area and the associated cost.

The work to optimise heat exchanger networks was more oriented to a mathematical approach instead of an engineering like approach. In addition in the beginning it

was not possible to deal with industrial problems, as the computing time to handle even a very small number of streams was too high. This is due to the fact, that the number of possible matches between different streams increases exponential with the number of streams. If a number of 4 cold streams  $N_c=4$  and a number of 3 hot streams  $N_h=3$  is assumed, we have already to deal with  $N_s = (N_h * N_c)! = (3 * 4)! = 12! = 479$  million different combinations which have to be analysed. Typical industrial problems have however stream sets of 20 to 30 hot and cold streams, which made it impossible to solve the problem.

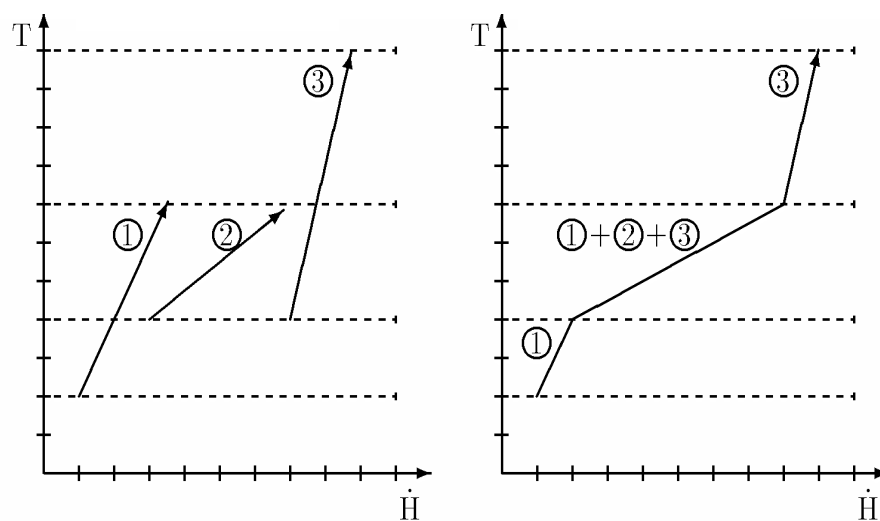
Even with today's modern computers this type of approach of brut force computing seem to be not the best solution, as the number of combinations that has to be analysed can be drastically reduced with the technical insight of thermodynamics.

In the following we will therefore explain how process insight can be gained by using pinch analysis, helping to reduce the number of possible configurations to be analysed.

### USING PINCH ANALYSIS FOR PROCESS OPTIMISATION

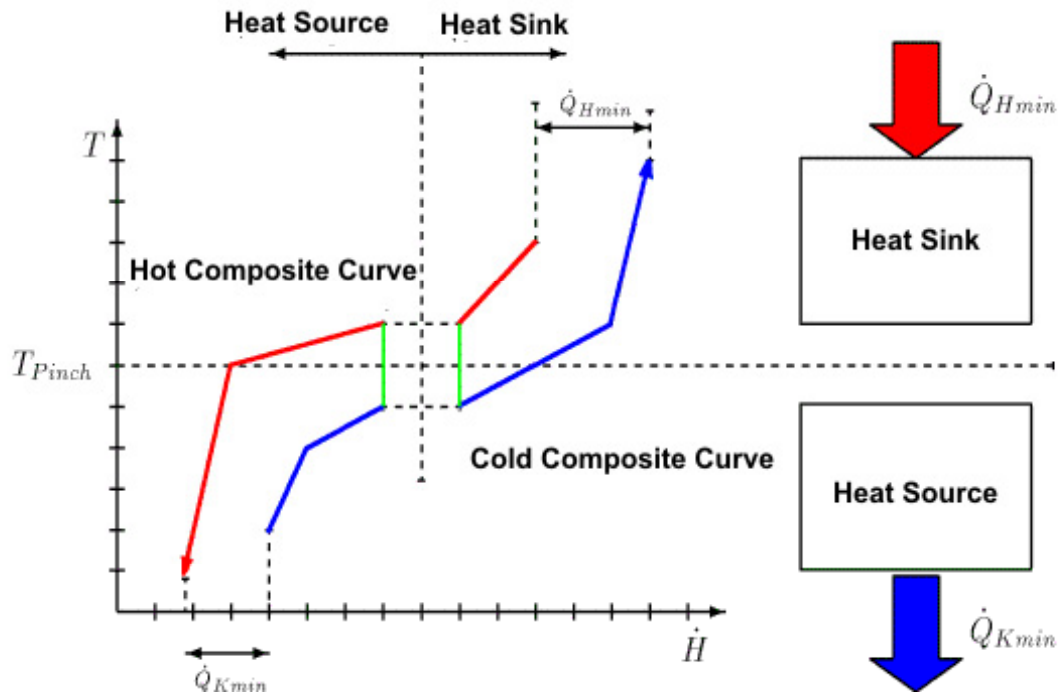
The basic elements of the pinch analysis are the composite and the grand composite curve (Linnhoff, 1982). They are constructed from the stream data of the process and a minimum driving temperature difference for heat transfer between hot and cold streams. In Pinch Analysis a hot stream is defined as a stream which have to be cooled and a cold stream is defined as a stream that have to be heated to reach it's final required temperature.

Figure 1 show on the left three single streams which have to be heated in a temperature-enthalpy-Diagram (T-H-Diagram). At each entry or exit temperature of a stream, a temperature interval boundary is set. The heat capacity flow rate of all streams in an interval is added to construct the new curve, so that all streams are combined into one single stream that has to be heated. If the same procedure is applied to the hot streams independently, the overall process and its energy balance are represented by a hot and a cold composite curve which can be shown in the same diagram, Figure 2. As enthalpy is relative, the curves can be moved horizontally without any problem. The hot composite curve should be every time above the cold composite curve, otherwise the cold composite curve has to be shifted to the right.



**FIGURE 1: Constructing the Composite Curve. From single streams (left) to the composite curve (right)**

The position at which the smallest temperature difference between the two composite curves occurs is called the Pinch. This diagram gives the very valuable insight that the Pinch divides the process into two sub processes, a heat sink above the Pinch and a heat source below the Pinch.



**FIGURE 2: The Composite Curves and their use for setting energy consumption targets**

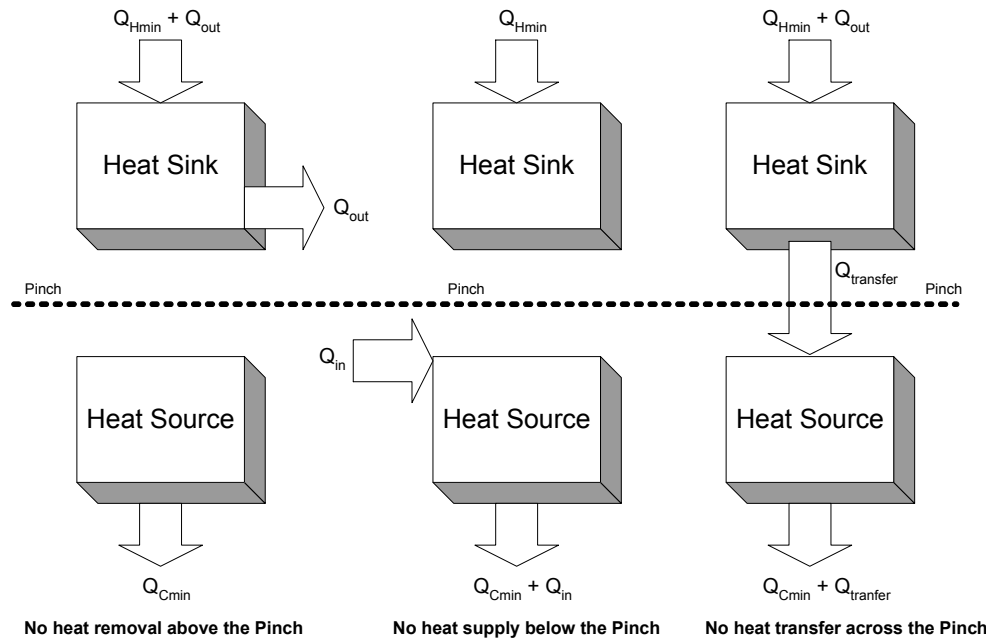
In addition the correlation between the minimum driving temperature difference and the minimum heating and cooling demand can be clearly understood. A higher required temperature difference at the Pinch Point will force the cold composite curve to be shifted to the right, reducing the overlap between the composite curves (the heat recovery area). At the same time more heat is required from utilities to heat up the cold streams. Based on the first law of thermodynamics this will also increase the cooling demand of the system.

### The Pinch Rules to Achieve Minimum Energy Consumption

Therefore to achieve the minimum heating and cooling requirements for the process, three rules have to be followed which are presented in a graphical manner in Figure 3. Heat should not be removed above the Pinch by cooling water as this will increase the heating demand of the heat sink, without influencing the heat source. If heat is supplied below the Pinch, where there is already a heat surplus, the total heating and cooling demand will increase. Not always heat needs to be supplied or removed by utilities to violate the Pinch rules. Often Pinch rules are violated by an incorrect matching of hot and cold streams, a fault which is not easily detected. If the hot stream has a temperature above the Pinch and the cold stream below the Pinch, the heat exchanger will work properly. However as this heat exchanger is using excess driving temperature difference, this will lead to constraints in other heat exchangers. In fact this will make additional external heat supply at temperatures above the Pinch necessary.

### Process Modifications for better Heat Integration

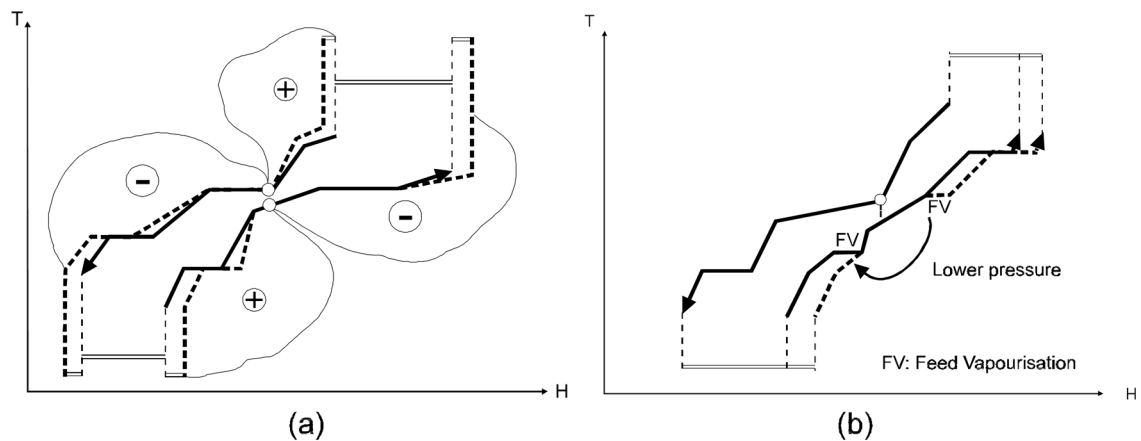
The minimum energy requirements set by the composite curves are based on a given process heat and material balance. If the heat and material balance could be changed it might be possible to further reduce the energy requirements. This can be obtained by changing for e.g. distillation column operating pressures and reflux ratios, feed vaporisation pressures, pump-around flowrates and reactor conversion rates. The number of possibilities is very large and therefore it would be very advantageous to identify the changes that really help to improve the system. By Pinch Analysis (using the "plus-minus principle") it is possible to identify changes in the appropriate process parameter that will have a favourable impact.



**FIGURE 3: The Pinch Rules to achieve Minimum Energy Consumption**

### The plus-minus principle for process modifications

The composite curves of the process are determined by the heat and mass balance and so if these are changed, the composite curves will change accordingly. Figure 4a summarizes the impact of these changes on the process energy targets.



**FIGURE 4: The +/- Principle. (a) Modifying Process Parameters (b) Temperature changes so that streams move from above Pinch to below Pinch**



Any increase in hot stream duty above the pinch or any decrease in cold stream duty above the pinch will result in a reduced hot utility target. Vice versa any decrease in hot stream duty below the pinch or any increase in cold stream duty below the pinch will result in a reduced cold utility target.

This easy to understand principle provides a definite reference for any adjustment in process heat duties, such as for e.g. vaporisation of a recycle, pump-around condensing. Often it is possible to change temperatures rather than heat duties. Figure 4b illustrates that temperature changes across the pinch will change the energy targets. If the feed vaporisation (FV) pressure is reduced the evaporation temperature is lowered and the feed vaporisation duty is moving from above to below the pinch, which will reduce heating and cooling targets by the vaporization duty. The same principle can be applied on the hot composite curve, when duties are shifted from below to above the Pinch. Therefore it is possible during the design to easily identify the process modifications which would be beneficial.

### Distillation Column Modification

Even if distillation columns typically are only represented by the reboiler and condenser duties in Pinch analysis, the Pinch principles can also be applied to the column itself. Figure 5 shows the three different opportunities for improvements, the scope for a reflux reduction (a), the use of feed preheating (b) and the use of side reboilers or condensers (c). The T-H column profile can be obtained from a column simulation or short cut calculation for each stage of the column. The horizontal gap in (a) indicates the possibility to reduce the reflux ratio. It should be kept in mind, that in existing columns, the reflux can be reduced if additional stages can be added or if the efficiency of each stage can be improved.

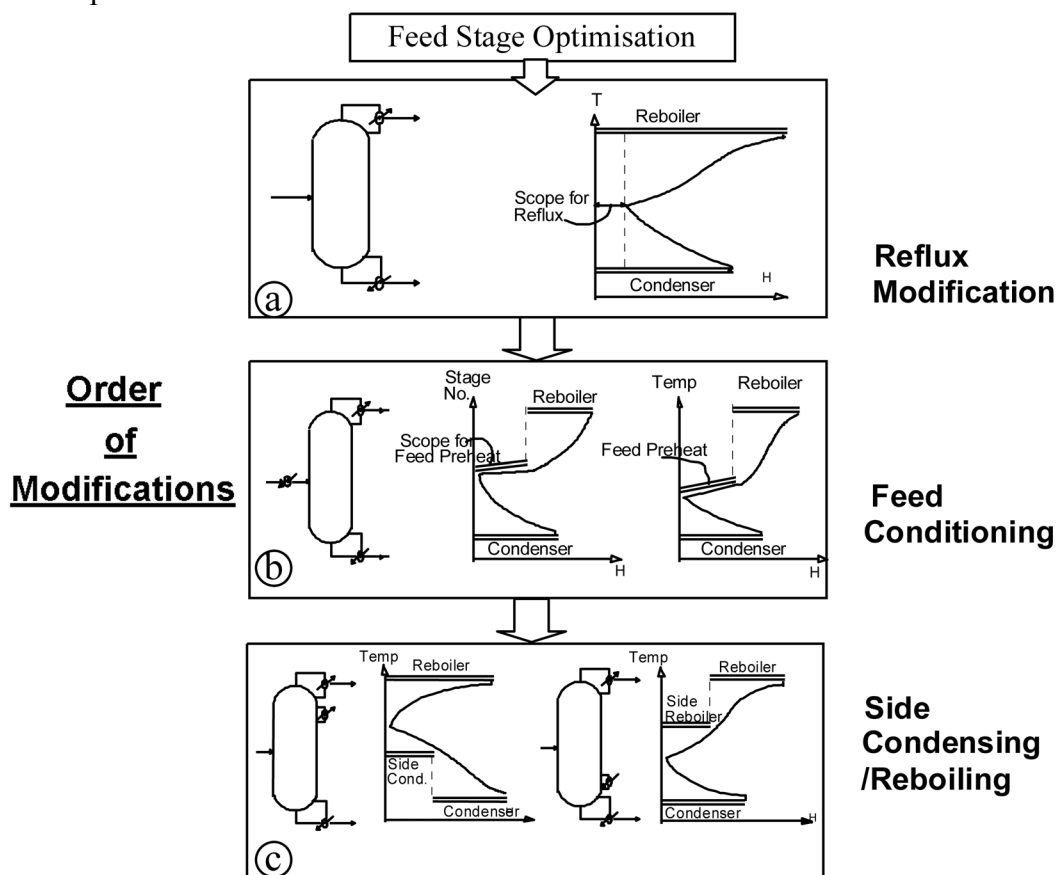


FIGURE 5: Distillation Column Optimisation with Pinch Analysis (Linnhoff, 1998)

A second option is the preheating of the column feed (b). This is typically feasible, if a sharp change in the column profile can be seen close to the stage to which the feed is supplied. Feed preheating will move part of the required heat duty from the reboiler to the feed preheater and thus to lower temperatures. Finally a side reboiler or condenser can move part of the heating or cooling duty of the column to higher or lower temperatures (c). However this additional equipment will increase the column cost.

### THE INTEGRATION OF DIFFERENT UTILITIES INCLUDING HEAT ENGINES AND HEAT PUMPS

Pinch Analysis not only helps in understanding the process and the process heat recovery but it can also be used to select the right utilities. Whereas the composite curves can be easily used to determine the amount of heating and cooling required, an additional tool of Pinch analysis, the Grand Composite Curve (GCC) can be used. The GCC is built from the composite curves by shifting the hot composite curve by  $-\frac{1}{2} \Delta T_{\min}$  and the cold composite curve by  $+\frac{1}{2} \Delta T_{\min}$ . The hot and cold composite curve will then touch at one point, the Pinch. For each temperature the difference between the enthalpy of the cold composite and the enthalpy of the hot composite curve is derived. The temperature is then plotted over the enthalpy difference, which means that the curve will touch at the Pinch the temperature axis. The heat demand above the Pinch has to be covered by utilities, where the temperature of the utility used needs to be high enough to ensure that the temperature is always higher than the GCC above the Pinch.

#### Choosing the right Utilities

In Figure 6 the GCC of a process is shown together with the representation of the utilities. Three different options are represented, high pressure steam, high and medium pressure steam and a combustion. As smaller the area between the profile of the utility and the GCC as lower the exergy losses are. If for e.g. medium pressure steam can be used instead of high pressure steam, more steam can be expanded to a lower steam pressure which will increase electricity generation in the steam turbine.

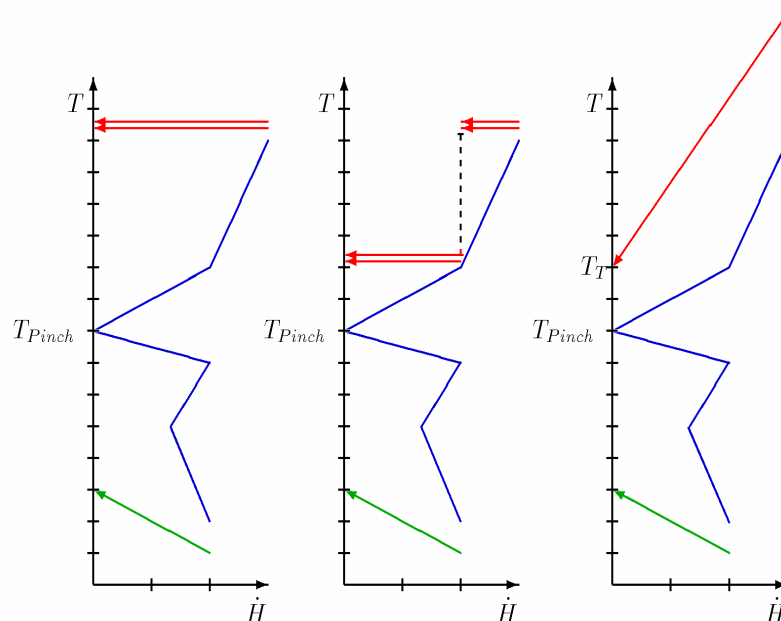


FIGURE 6: Choosing the best utilities (Radgen, 1996)

Wish type of utility will be best suited will depend on the process and it's GCC. GCC with a large horizontal area above the Pinch will be better suited for condensing type utilities where as GCC with more vertical areas above the Pinch will be better suited for the heat supply by combustion gases (Sarabachi, 2002). If this is further developed for CHP technologies, different GCC will favour the use of gas turbines (left), others the use of steam turbines (right), Figure 7.

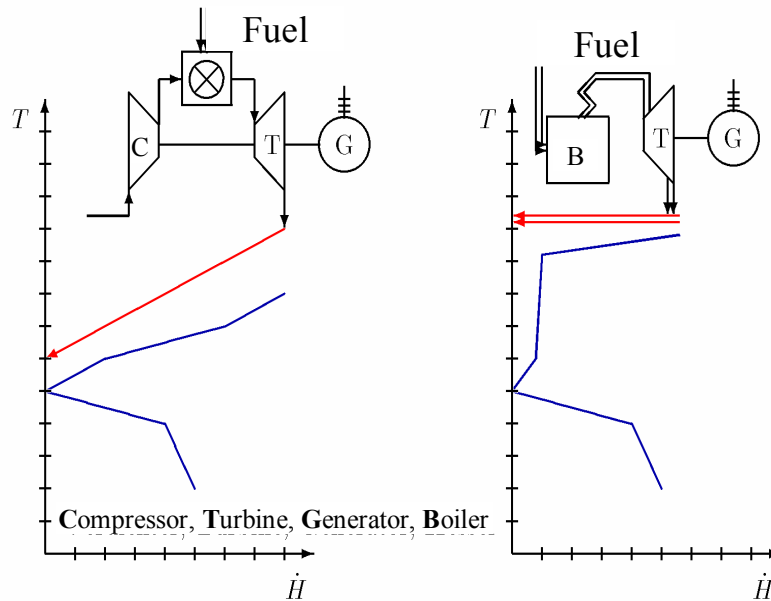
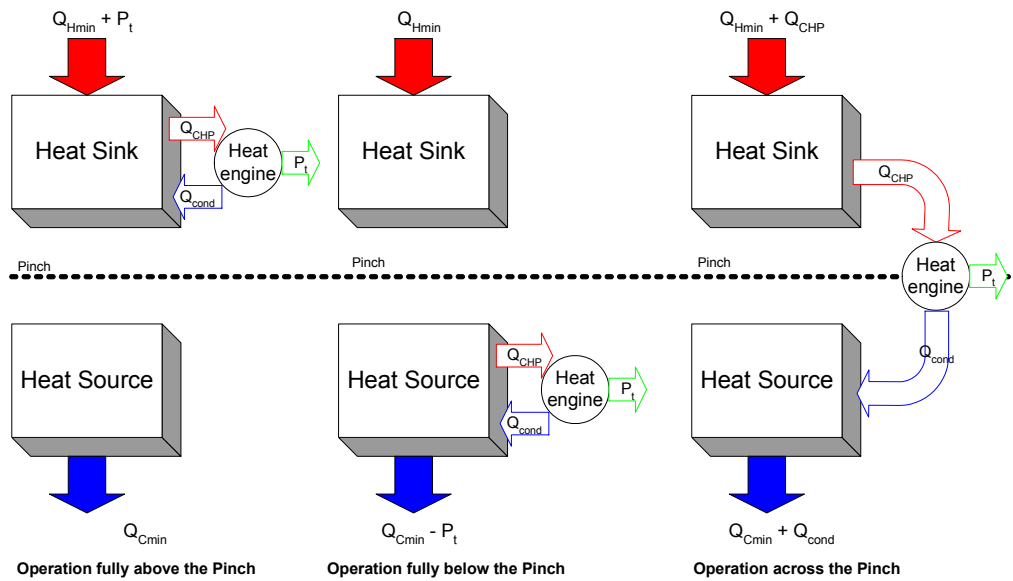


FIGURE 7: Choosing the best utilities (Radgen, 1996)

From this diagrams also some principle rules for the integration of heat engines into the overall process can be derived.

### Integration of Heat Engines

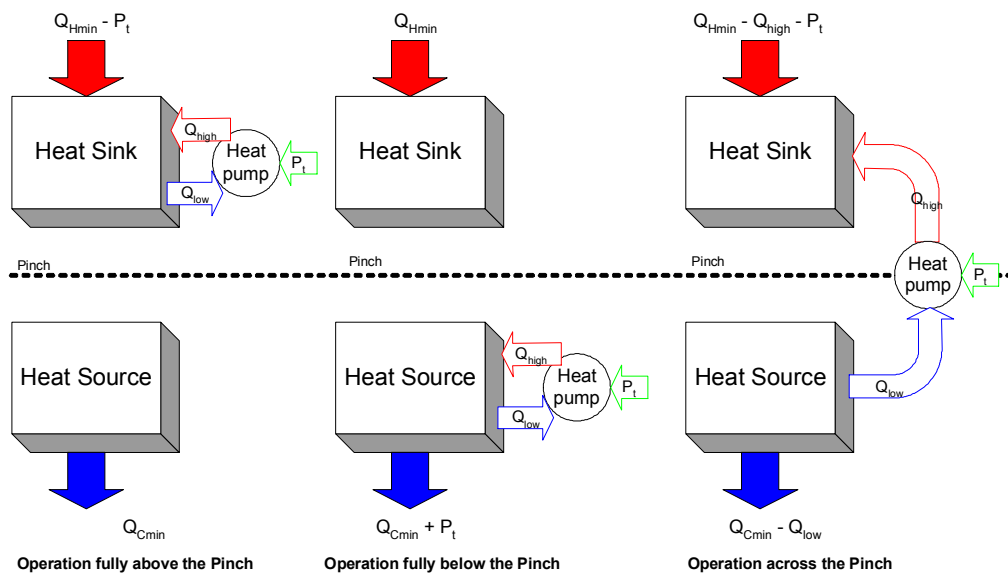
If the heat engine is operating fully above the Pinch, the heat engine seems to be converting 100 % heat into 100 % of electricity. This integration will thus be very beneficial. The second possibility would be to use the waste heat available below the Pinch to drive the heat engine. In this case electricity could be produced and at the same time the cooling load can be reduced. However, there is a risk of faulty integrating of heat engines. This could be the case, when the heat engine is operating across the Pinch. If the heat is taken out from process streams above the Pinch and the condenser of the heat engine rejects heat below the Pinch, there would be no advantage in the integration. The integrated process configuration would consume the same amount of energy as if the heat engine and the process would be operated separately, Figure 8.



**FIGURE 8: The Pinch Principle and the positioning of heat engines into the overall process**

### Integration of Heat Pumps

As for the heat engine to produce mechanical energy or electricity, the inverse engine or heat pump should be integrated properly to be beneficial. Figure 9 shows the three different integration options. However, only when the heat pump is operating across the Pinch, the energy consumption could be reduced. The heat pump needs to take out the heat where there is a surplus of heat and has to lift it to a temperature at which there is a heat deficit (heat sink).



**FIGURE 9: The Pinch Principle and the positioning of heat pumps into the overall process**

It is therefore clear, that a proper integration of heat engines and heat pumps into the process is essential for successful energy savings. Pinch analysis guides the decisions and helps to identify mismatches in the system.

### THE EXAMPLE OF A FERTILIZER COMPLEX

Pinch Analysis can be used for the optimization of large industrial plant. In the following, some examples are given, showing the usefulness of the approach for the example of a fertilizer complex, consisting of an ammonia and an urea plant. The full results of the analysis can be found in (Radgen, 1996). During the analysis of the ammonia process, the heating demand of the actual process was higher than the minimum heating demand calculated by the Pinch Analysis. Therefore one of the Pinch rules must have been violated in the process design. With the knowledge of the Pinch Temperature a heater below the Pinch and a number of heat exchangers working across the Pinch had been identified.

#### Heat exchanger working across the Pinch

Figure 10 shows one of these heat exchangers. The heat exchanger is the feed preheater of the synthesis gas before it is entering the first ammonia reactor. On the left, the heat exchanger numbered 08E003 is splitted into three sub-exchangers, one below, one across and one above the pinch. In this heat exchanger actually 5.5 MW are transferred across the Pinch and are therefore wasted. One solution to reduce the heat transfer across the Pinch would be the reduction of the temperature difference at the outlet of the exchanger. If this could be reduced to 10 °C, the heat transfer and therefore the utility consumption could be reduced by 4.9 MW.

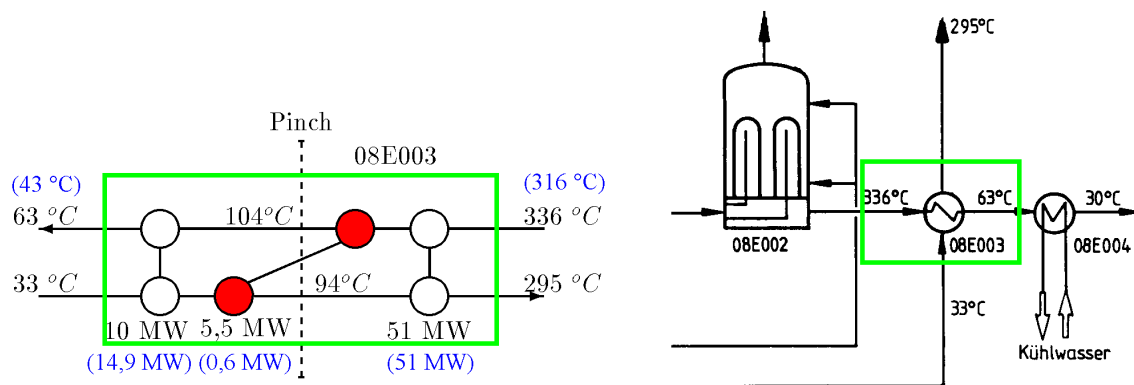
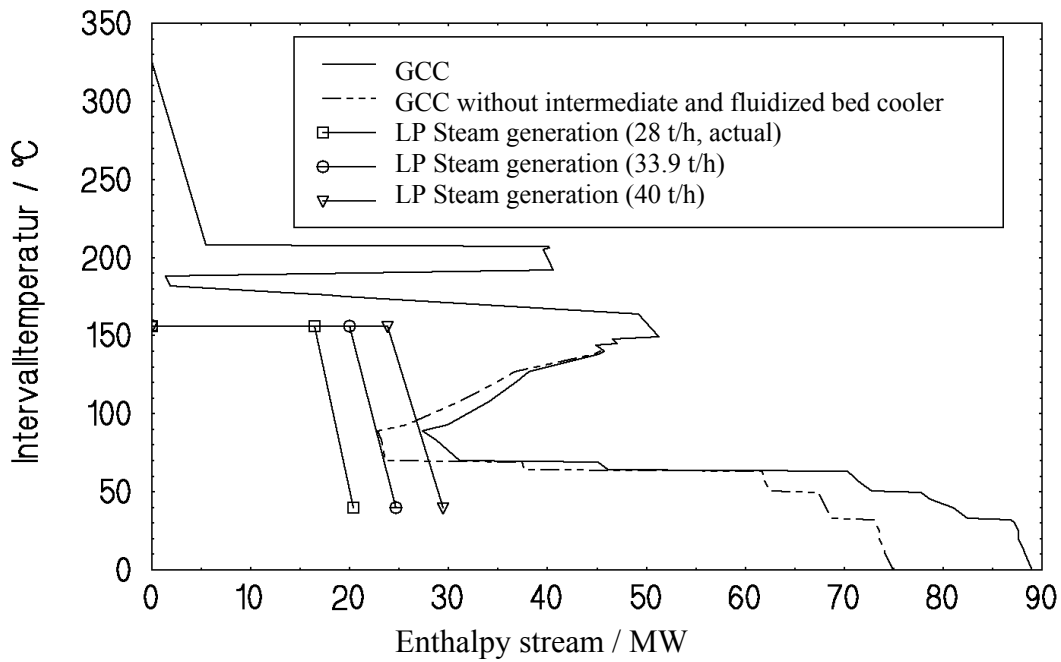


FIGURE 10: Heat transfer across the pinch

#### Increase use of waste heat for steam generation

As a second example the reduction of the cooling demand by increased low pressure steam generation is presented. Figure 11 shows the GCC of the urea process together with different LP steam generation profiles. Actually 28 t/h of LP steam are generated from the waste heat, however the GCC indicates, that much more heat is available for steam generation.

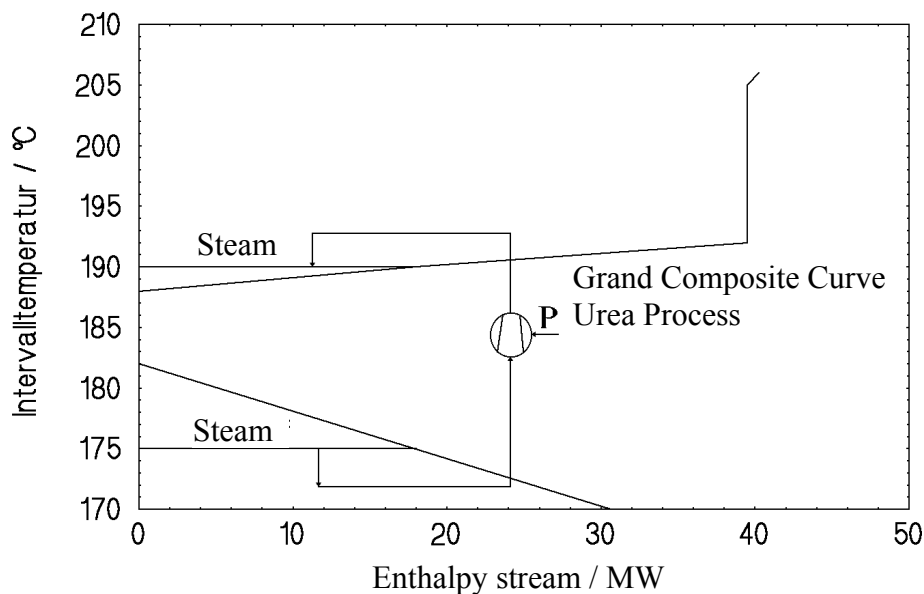


**FIGURE 11: Heat transfer across the pinch**

Based on the heat available from the urea process, the steam generation could be increased to 40 t/h. However some technical aspects have to be taken into account. In the case of the urea process heat available from the intermediate and fluidized bed coolers have to be recovered from solid materials, which is typically very difficult. If this heat is deducted from the GCC, the possible steam generation is reduced, but there is still a significant potential to increase the steam generation up to 33.9 t/h.

#### **Use of a heat pump in the urea process**

If a significant amount of heat is available with a temperature close to the Pinch and at the same time an equivalent heat requirement just a bit above the Pinch is available, the use of a heat pump should be evaluated. Figure 12 shows the GCC of the urea process in the area around the Pinch temperature. In this area, the temperature difference between the stream above the Pinch and the one below the Pinch is small, making it feasible to lift the heat via a heat pump above the pinch. In this case the heat pump would work across the Pinch (see Figure 9) and could therefore save energy. Typically the streams themselves could not be used as heat transfer fluid, therefore steam generation in combination with a vapour compressor could be applied as heat pump. However, the use of an intermediate heat transfer fluid will increase the required temperature difference and increase the power demand to drive the heat pump.



**FIGURE 12: Possibility to use a heat pump in the urea process**

In the case evaluated the steam needed to be compressed from 0.8 to 1.4 MPa. About 18 MW of waste heat could have been used in the heat pump. The vapour compressor would consume about 3 MW of electrical energy, which in total would have reduced the heat requirement of the process by about 21 MW. However this measure had been classified not economical, as it was more advantageous to increase the low pressure steam generation from the waste heat.

## SUMMARY AND CONCLUSIONS

The first and second laws of thermodynamics are the basis of the Pinch Analysis. Pinch Analysis is providing very helpful graphical tools which make it easy to understand the linkage between temperature and heat flows through a process. This insight enables the engineer to improve existing processes or to improve the design of new processes. Pinch Analysis guides through the different process optimisation steps and includes the design of the utility system. Even with today's high sophisticated process simulators and optimizers, the understanding of processes via the graphical representation in the Pinch analysis is of major importance.

During the last 15 years the Pinch principles had been adopted for other fields quite similar to heat integration. Today the Pinch principles are used for the optimisation of total sites, water systems and hydrogen systems in refineries (Smith, 2000).

## REFERENCES

- Ciric, A.R.; Floudas, C.A.; Grossmann, I.E., 1986: *Automatic synthesis of optimum heat exchanger network configuration*. AIChE Journal, Vol.32, No.2, pp.276-290.
- Linnhoff, B., 1979: *Thermodynamic analysis in the design of process networks*. Ph.D. Thesis, University of Leeds.
- Linnhoff, et. al., 1982: *User guide on process integration for the efficient use of energy*. The Institution of Chemical Engineers, Pergamon Press.
- Linnhoff, B., 1998: *Introduction to Pinch Technology*. Linnhoff March, U.K..
- Radgen, P.:1996: *Energiesystemanalyse eines Düngemittelkomplexes*. VDI Fortschrittsberichte, VDI Verlag, Düsseldorf.
- Sarabchi, K., Polley, G., 2002: *Gas Turbine Direct Integration in the Context of Pinch Technology*. Chem.Eng.Technol., Vol. 25, No.8, pp. 829-839.
- Smith, R. 2000: *State of the art in process integration*. Applied Thermal Engineering, Vol. 20, pp. 1337-1345.





# APPLICATION OF MULTI OBJECTIVE PINCH ANALYSIS

**Hannes Schollenberger, Martin Treitz**  
University of Karlsruhe (TH), Germany

A case study from industrial coating in Chile is used to demonstrate the application of Multi Objective Pinch Analysis. The aim is to investigate if it is reasonable for the company to modify its process to fulfil new emission thresholds earlier than required. The selected technological alternatives are compared to the actual process on the basis of environmental and cost criteria which are partly determined using pinch analysis. Two methods of aggregation are implemented: a metric and a multi-criteria approach. Furthermore, sensitivity analyses are carried out to examine the robustness of the decision and to gain a deeper understanding of the decision problem. The results of this case study indicate that for the chosen framework there is no clear preference for one alternative, but condensation of solvents and a switch to waterborne basecoats show comparable performances.

## PREFACE

The focus of the article is the application of the methodology introduced in an earlier chapter (Geldermann, 2005). Therefore, a case study from the sector of industrial coating in Chile is used. All calculations and analyses are performed by using the standard *Matlab*<sup>1</sup> and its *OptimizationToolbox*. The general setting is introduced in the next section. In the main part of this paper, the various pinch modules of MOPA (cf. energy, water and VOC targets) are calculated for the selected case study. Summarising, the findings the results are aggregated using the metric and a multi-criteria approach.

## CASE STUDY: INTRODUCTION AND BACKGROUND

Modifications in the processes of various Small and Medium Sized Enterprises (SME) are necessary within the next two years, in order to fulfil the new limit values for emissions of Volatile Organic Compounds (VOC). In this case study, the serial coating of bicycle and bed frames is investigated. The main question to be answered is if it is worthwhile to modify the paint application process sooner than legally required or to postpone process modifications until the requirements become effective in two years. Additionally, energy savings potentials are calculated to identify further improvements of the process.

### Assumptions and General Setting

The investigated company is a middle sized firm producing bicycles (approx. 79,850 per year with an average surface area of 39.7 dm<sup>2</sup> of the bicycle frame) and beds (approx. 12,000 pieces per year with an average surface area of 361 dm<sup>2</sup> of the various parts). The focus of the analysis are the paint application steps of the production process, which are technically similar for both products, henceforth called frames generalised. The construction of the frames as well as assembling and packaging steps are not taken into account.

---

<sup>1</sup> *Matlab* is a software package of *Mathworks* for technical computing, numerical calculations and data analysis, [www.mathworks.com](http://www.mathworks.com)

### Process Schema and Scenarios

After the pre-treatment steps (degreasing, passivation, water cleaning and phosphating), the frames pass through four coating steps (filler application, two paint applications and finally a clear coat application) followed by a drying step. The spray booths and flash-off zones and the drying oven have a separate waste gas system (around 96% of the solvents are emitted in the booths and flash-off zones and the rest in the drying oven) (cf. FIGURE 1). The major solvent used is Xylene (CAS No 95-47-6) with a molecular weight of 106.167 kg/kmol. Some share of the overall solvents used are in the paint and some are bought extra to dilute the paint and adjust the spraying parameters such as viscosity. The temperature dependent properties (heat capacity, saturation pressure etc.) are assumed to be similar to an ideal gas and are approximated by pure component specific parameters.

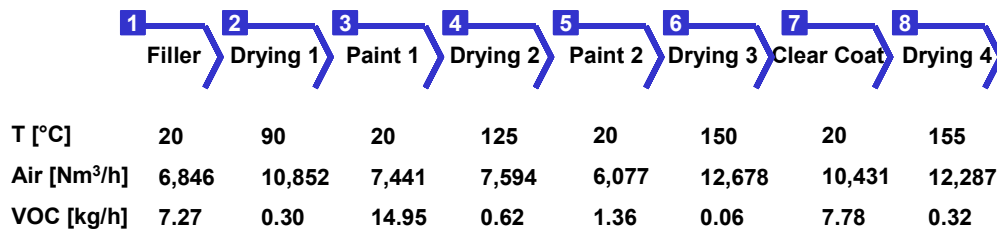


FIGURE 1: Process Layout of the coating process

### Energy Savings Potential

In the current process layout each stream is heated up separately and released after the drying tunnel using independent fresh air sources for each oven (*baseline scenario*). This *baseline scenario* is compared to a scenario using the heat of the production process being released during the cooling down of the waste gas to 40 °C. The air flows of the drying ovens are preheated using the released heat and the overall energy consumption is reduced (*heat integration scenario*). Further measures for improving the general energy efficiency are discussed in literature, but not included in this case study.

### Emission Abatement Options

Considering various design modifications and variants (Thermal Oxidizer vs. Regenerative Thermal Oxidizer (RTO)) three different emission abatement options can be identified to be compared to the *Status quo* (abbr.  $T_0$ ): a complete shift to *Waterborne Coatings* ( $T_1$ ) as process integrated measure and the two additive measures of *Thermal Incineration* ( $T_2$ ) and the recovery of the solvents with a *Condensation* ( $T_3$ ).

The criteria for the evaluation are based on the mass and energy flows of the company. The evaluation is based on a relative assessment of the alternatives compared to target values for each criterion ( $S_{pinch}$ ) which are calculated using the pinch analysis approach (cf. next section and (Geldermann, 2005)). The selected criteria for the evaluation are:

- *Energy Consumption [kWh/h] (Energy)*
- *Fresh Water Consumption [m<sup>3</sup>/h] (Water)*
- *VOC Emissions [mg C/m<sup>3</sup>] (VOC)*
- *Investment for Abatement Installation as annualized costs [€/a] (InvDep)*
- *Change in Operating Cost due to be Purchased Solvents [€/a] (Cost)*

The last criterion (*Cost*) covers the change in operating cost pertaining purchased solvents. In industrial coating fillers and paints are in general bought not ready

for application but with a lower solvent content than required (e.g. solvent content of filler bought: 53 %). Thus, additional solvents are bought to adjust the viscosity of the paint right before the application (e.g. solvent content of filler ready for application: 76.5 %). Furthermore, additional solvents are required for cleaning equipments such as spray guns. Hence, the amount of solvents recovered determines the amount of additional solvents that have to be bought.

Since the level of VOC emissions is not really an evaluation criteria because all abatement options have to fulfil the emission threshold for VOC, two separate analyses are carried out: One multi-criteria evaluation using all five criteria (*full criteria set*) and one analysis using all criteria but VOC Emissions since it is assumed to be a knock-out criterion and fulfilled by all alternatives (*abridged criteria set*).

## MULTI OBJECTIVE PINCH ANALYSIS (MOPA)

### Calculation of the energy target values

Calculations of the energy pinch analysis are done using the classical transport algorithm as described in (Cerda et al., 1983) rephrased with truncated incidence matrices to a standard linear programming problem. Both, the drying air of the process requiring heating and the cooling air of the counter-current flow are taken from the outside air supply (assumed to be 20 °C). Auxiliary processes such as the preheating of drying ovens, the cleaning of tools, or the mixing of the filler or paint exist in addition to the main painting process, but are not included in the investigation of this case study. Nevertheless they may also provide significant potential for the conservation of resources. Furthermore, the air flows of the spraying booths and the flash-off zones are not considered as they do not need any heating at all. 4% of the solvents are emitted in the drying ovens and are therefore relevant for the *heat integration scenario*. The minimal temperature difference between the hot and the cold composite curve is assumed to be  $\Delta T_{min} = 10^\circ$ .

The *baseline scenario* requires a heating of 5,062,526 kJ/h (= 1406.3 kWh/h), which is lost during the cooling down of the air flows. As FIGURE 2 illustrates, in the *heat integration scenario* the pinch points are situated at the bottom of the hot and cold composite curve leaving a requirement of hot utility at the upper end of the composite curve of around 300 MJ/h (= 83.5 kWh/h). Hence, the theoretical savings potential is about 94 % and the major heating requirements for the ovens could be met by heat integration of the hot waste gas.

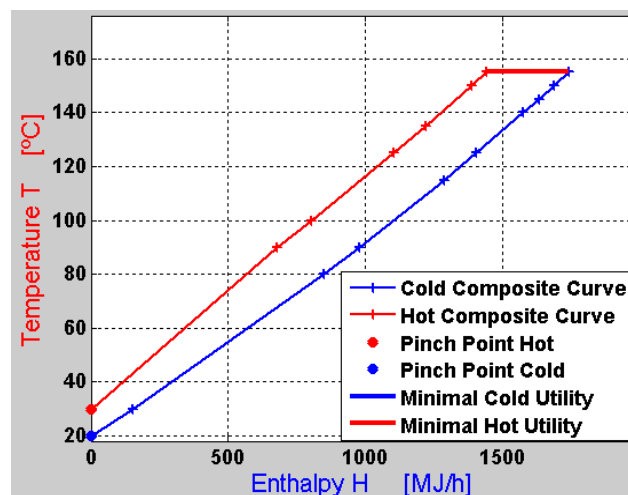


FIGURE 2: Hot and Cold Composite Curves Energy

### Calculation of the VOC target values

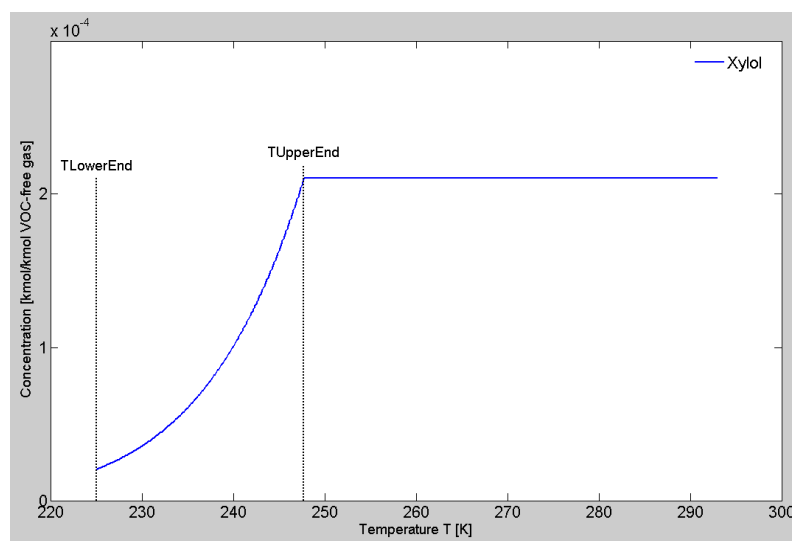
The thermal condensation of solvents can be described as a heat exchanger problem and thus be evaluated by the pinch analysis approach (Dunn and El-Halwagi, 1994, Parthasarathy and El-Halwagi, 2000). The analysis is based on temperature – concentration relationships depending on the temperature-sensitive saturation pressure curves of the considered pure or multi-component VOC. The calculation also considers the temperature dependent heat capacities of the waste gas and the partly cleaned waste gas after condensation. Furthermore, the heat of condensation is taken into account as well as the heat capacity of the condensed liquid solvent.

In contrast to the heat integration scenario, discussed in the last section, the condensation is applied to the 96% of the solvent emissions of the booths. The flash-off zones are relevant to the condensation. Since the warmer air stream of the drying ovens has a significant lower solvent concentration it is unreasonable to mix the streams and cool down the higher volume of air afterwards. Hence, the streams of the drying ovens are not used for the condensation.

The temperature range to be considered for the calculation of the condensation is given by the supply temperature of the air flow (in this case 20°C (293 °K)) as the upper bound and the maximum of system dependent temperatures (freezing point of the coolant, minimal system temperature, freezing point of solvent etc.) as the lower bound. In this case study the freezing point of Xylene at - 48 °C (225 °K) defines the lower bound of the temperature range.

The starting point of condensation depends on the solvent concentration in the air which is 1001 mg/m<sup>3</sup>. This concentration accrues from the solvents contained in the paint and the solvents used for dilution. The flow rate of the air is 30,800 Nm<sup>3</sup>/h. Both data are calculated on the basis of air quality measurements.

The condensation of Xylene in the waste gas starts at 247.7 °K (T<sub>UpperEnd</sub> in FIGURE 3). The objective of the analysis is to determine the economic reasonable amount of solvents to be recovered which can be translated into an endpoint temperature ( $T_{End}$ ) of the condensation at which this recovery target is reached. The costs for running the condensation are calculated as total annual costs comprising fixed costs for the installation of heat exchangers and operating costs for the additional cooling by liquid nitrogen.

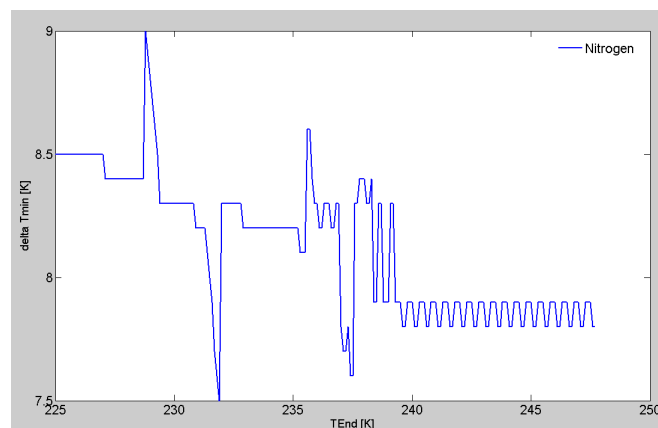


**FIGURE 3: Concentration of Xylene**

The heat to be integrated and the heat to be dissipated depend on the endpoint temperature of the condensation. The heat exchanger between the waste gas and the full or partly cleaned cold gas is characterized by surface dependent investment without considering possible operating (e.g. for maintenance) costs and heat transfer losses. The heat exchanger in the lower temperature range considers not only the investment of the heat exchanger, but also the consumption of coolant based on their specific heat transfer coefficient. The condensed solvents are also cooled to  $T_{End}$  since an advance extraction is not considered. Parameters such as geometry and material are not explicitly considered.

The integrals of the heat balance are solved in *Matlab* numerically with a linear approximation in 0.1 °K steps. The solution is driven by the trade-off between the amount of recovered solvents and therefore the revenues for the solvents and necessary investment in heat exchanger and coolants (e.g. liquid nitrogen). For each endpoint temperature of the condensation within the condensation range (247.9 °K to 225 °K) and for each  $\Delta T_{min}$  within an assumed range (2 °K to 20 °K) the total annual costs are determined. Depending on the quality requirements of the process the recovered solvents can be used either in the same process or in a different application or both since the solvents within the paint can also be recovered it is possible that more solvents are recovered than are necessary in the process.

FIGURE 4 shows that the minimal temperature gradient  $\Delta T_{min}$  for the use of liquid nitrogen as a coolant between the raw gas and the partly cleaned waste gas depends on the end point of condensation.



**FIGURE 4: Variation of the best temperature gradient depending on the end point temperature of condensation**

The analysis reveals that the optimal temperature gradient is 8.5 °K and at an end temperature of condensation at the minimal possible temperature of 225 °K. The annualized costs for the heat exchanger would be 38,214 €/a (assuming a 4% interest rate and economic life time of 10 years) and together with the residual value of the current plant resulting in 107,214 €/a (cf. TABLE 1). Since more solvents are recovered than have to be purchased additionally, due to the solvents delivered with the paints directly, savings of 7,785 €/a can be realized instead of spending 38,461 €/a (cf. TABLE 1). The calculated end point temperature of condensation leads mixed together with the air flows of the ovens to overall solvent emissions of 57.5 mg C/m<sup>3</sup> and an air flow of approx. 75,000 Nm<sup>3</sup>/h waste air (cf. TABLE 1).

The thermal incineration is quite effective compared to the condensation leading to emission values of 99% of the initial concentration (in this case the stream of the

booths, flash-off zones and the drying tunnel are lead through the thermal oxidizer). But is has a quite high initial investment of around 460,000 € (assuming a specific economic life-time of 20 years, an interest rate of 4% and an residual value of 75,000 € results in annual costs of over 30,000 €/a) and also high operating costs since all burned solvents have to be replaced by new ones. Compared thereto, the switch to waterborne basecoats shows a smaller investment and lower operating costs (~10,000 €/a), but also significant lower abatement efficiency (~227 mg C/m<sup>3</sup>) (cf. TABLE 1).

### Determination of the Water target values

The target values concerning the water consumption are based on the process characteristics of the different techniques in relative comparison to the current consumption. The current consumption is based on the different water consuming process steps, their absolute consumption and relative frequency (e.g. cleaning of painting booth 1 m<sup>3</sup> per week or change of 46 m<sup>3</sup> acid passivation bath twice a year) resulting in an water consumption of 0.28 m<sup>3</sup>/h (cf. TABLE 1). Through various process improvement measures (like the extension of life-time of pretreatment baths) this consumption can be lowered to 0.15 m<sup>3</sup>/h as the target for the analysis.

### CASE STUDY: METRIC RESULTS

Compiling all the different information together (cf. TABLE 1) a first relative assessment can be obtained by a metric defined as a modified Euclidian norm (Treitz et al., 2004). This analysis shows that the switch to waterborne coatings has the highest saving potential (20.9 %) and also the option of condensation (15.1 %) performs better compared to thermal incineration (3.1 %), which would actually present the smallest improvement.

**TABLE 1: Metric - Characterisation of the assessed techniques**

Criterion	Unit	Weight	S <sub>pinch</sub>	(T <sub>0</sub> )	(T <sub>1</sub> )	(T <sub>2</sub> )	(T <sub>3</sub> )
Energy	[kWh/h]	0.15	83.5	1,406.2	1,381.2	1,476.5	1,448.4
Water	[m <sup>3</sup> /h]	0.15	0.15	0.28	0.28	0.20	0.30
VOC Emissions	[mg C/m <sup>3</sup> ]	0.20	0.0	393.9	227.2	3.9	57.5
Inv. dependent	[€/a]	0.20	0.0	69,000	78,000	99,575	107,214
Operating Cost	[€/a]	0.30	0.0	38,461	20,672	38,461	-7,785
d <sub>λ</sub> <sup>norm</sup>	-	-	-	0.464	0.367	0.467	0.388
δ <sub>MOPA</sub>	-	-	-	0 %	20.9 %	3.1 %	15.1 %

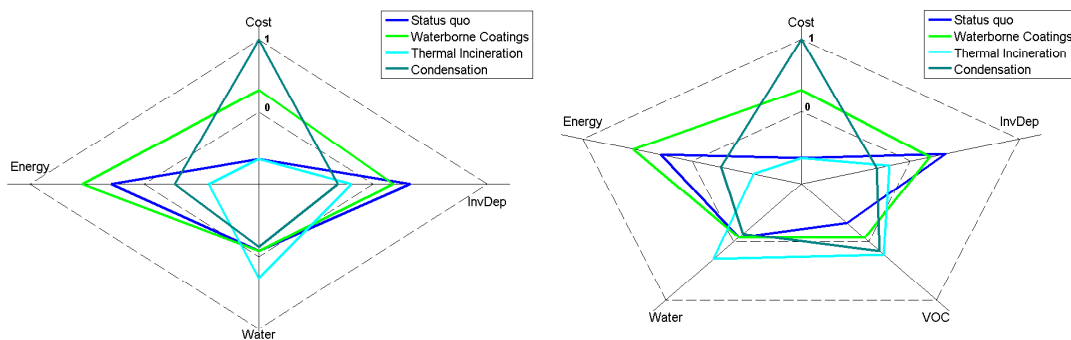
### CASE STUDY: MULTI-CRITERIA ANALYSIS AND RESULTS

Another possibility for the simultaneous consideration of the various criteria is the application of a multi-criteria analysis. In this case study, the same data-set is used for the evaluation with the multi-criteria method PROMETHEE (Brans and Mareschal, 2005, Brans et al., 1986). In contrast to TABLE 1, here not the absolute, but the relative difference to the pinch values are used for the evaluation (cf. TABLE 2). The table shows also the weighting for all five criteria as used in the metric for the full evaluation and an adjusted weighting for the abridged set of criteria.

**TABLE 2: Multi-Criteria Characterisation of the assessed techniques**

Criterion	Unit	Weight full (abridged)	Status quo (T <sub>0</sub> )	Waterborne Coatings (T <sub>1</sub> )	Thermal Incineration (T <sub>2</sub> )	Condensation (T <sub>3</sub> )
Energy Consumption	[kWh/h]	0.150 (0.189)	1,322.73	1,297.73	1,393.04	1,364.92
Fresh Water Consumption	[m <sup>3</sup> /h]	0.150 (0.189)	0.13	0.13	0.05	0.15
VOC Emissions	[mg C/m <sup>3</sup> ]	0.200 (-)	393.9	227.2	3.9	57.5
Investment	[€/a]	0.200 (0.252)	69,000	78,000	99,575	107,214
Operating Cost	[€/a]	0.300 (0.378)	38,461	20,672	38,461	-7,785

The analysis with the full set of criteria suggests an implementation of condensation as emission abatement option. Nevertheless, the difference between this alternative and a switch to waterborne coatings is very narrow. This is underlined by the fact that the switch to waterborne basecoats is ranked first in the abridged approach, again with only a small difference to condensation. The strength of condensation are the operating costs, whereas the strength of a switch to waterborne lies in the lower energy consumption and the smaller investment dependent costs. However, as the spider diagram (FIGURE 5) shows, the decision is influenced by conflicting criteria and depending on the preference parameters and the weighting, one or the other alternative is ranked first.

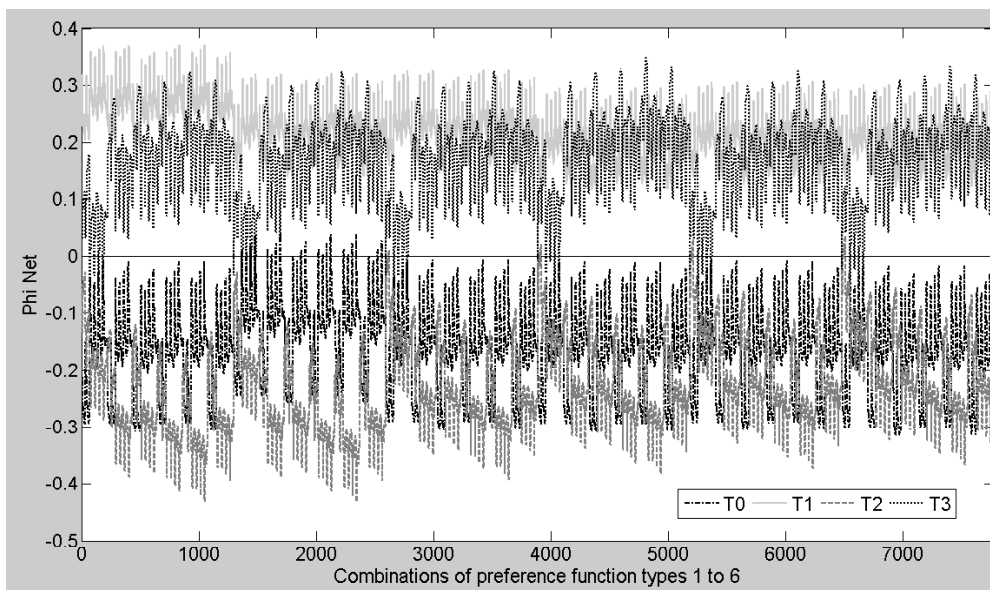
**FIGURE 5: Spider-Diagram of the abridged (left) and full (right) evaluation**

Therefore various sensitivity analyses (cf. TABLE 3) can be used to facilitate modeling and transparent depiction of the decision problem within PROMETHEE. On the one hand the robustness of a decision can be investigated by changing the weighting of one criterion from zero to 100% (cf. *SensWeightSingle* in TABLE 3). On the other hand the robustness of the parameters  $q$ ,  $p$ , and  $s$  of PROMETHEE can be investigated by carrying out a *Monte Carlo Simulation* using specific uncertainty levels (e.g.  $\pm 10\%$ ) (cf. *SensParamSingle* and *SensParamAll*) or by evaluating all possible preference type combinations (cf. *SensTypeSingle* and *SensTypeAll*).

**TABLE 3: Available Sensitivity Analyses**

Name	Variable	Fixed	Method	Output
SensParamSingle	Preference parameter of selected criterion	Preference type	Monte Carlo Simulation (uniform distribution)	$\Phi_j(a)$ (line plot)
SensParamAll	Preference parameter of all criteria	Preference type and weighting	Monte Carlo Simulation (normal distribution)	$\Phi_{net}(a)$ (box plot)
SensTypeSingle	Preference type of selected criterion	Preference parameter	Variation of all 6 preference types for selected criterion	$\Phi_j(a)$ (line plot)
SensTypeAll	Preference type of all criteria	Preference parameter and weighting	Variation of all 6 preference types for all criteria	$\Phi_{net}(a)$ (line plot)
SensWeightSingle	Weight of selected criterion	Preference parameter and type	Change of weight within [0,1]	$\Phi_{net}(a)$ (line plot)
SensWeightAll	Weights of all criteria	Preference parameter, type and weighting limits	Calculation of all valid weighting vectors	PROMTHEE VI Area in the GAIA plane
SensDataUncer	Attribute values	Preference parameter and type	Monte Carlo Simulation (normal distribution)	Scatter plot in the GAIA plane

Further calculations show that in the case of the permutation of all preference types I through VI (*SensTypeAll*) for all five criteria, alternative  $T_1$  and  $T_3$  change position depending on the final combination of preference type functions (cf. FIGURE 6). In this sensitivity analysis the weights and the preference parameters are fixed and the effect on the overall result is analyzed by only changing the type of preference function for each criterion. Herewith, the low robustness of the decision is demonstrated and emphasizes the need of a high transparency of the decision problem to be able to interpret the obtained results in the best possible way.

**FIGURE 6:  $\Phi_{net}$  flow of all possible preference type combinations**



Another approach used for sensitivity analysis is the Principal Component Analysis (PCA). By projecting the cloud of alternatives from the  $R^n$  onto the plane of the first two principal components the so-called GAIA plane can be spanned and the decision problem can be visualized (cf. FIGURE 7). Apart from alternatives and criteria axes, the weighting vector (the PROMETHEE decision stick  $\pi$ ) can be projected on the GAIA plane. By defining upper and lower bounds for each weight the convex hull of all valid weighting combinations can be projected on the GAIA plane, visualizing the range of  $\pi$ , i.e. the PROMETHEE VI area (cf. *SensWeightAll* in TABLE 3). Furthermore, if attribute values are characterized by a specific uncertainty level, a scatter plot based on a Monte Carlo Simulation can be displayed (cf. *SensDataUncer*) that visualizes the distinguishability between all alternatives (Basson, 2004). Hence, these analyses allow the simultaneous change of all weighting factors.

The GAIA plane is displayed for all criteria using the preference type VI and the parameter  $s$  as half the difference of the maximal and minimal attribute values. The GAIA plot can only further comprehension of the given problem since two distinct points in the  $R^k$  of  $k$  different criteria might be projected on the same point in the plane. The PROMETHEE VI area and  $\pi$  illustrate the influence of different weights, since they are not taken into account in the projections of the criteria and alternatives. Additionally, the scatter plot of the projections of the alternatives  $T_0$  to  $T_3$  shows the variation of the results as a consequence of the uncertainty of the data (*SensDataUncer*) using a Monte Carlo Simulation (uncertainty level of  $\pm 10\%$  and normal distribution). In this case an uncertainty of  $\pm 10\%$  is assumed for all attribute values of the alternatives, but in further analyses it might be reasonable to assume a more stringent range for more accurate data and a broader range for criteria which are more difficult to quantify.

To summarize, the analyses reveal that no clear preference for one alternative is obvious, since both condensation of solvents and a switch to waterborne basecoats show comparable performances.

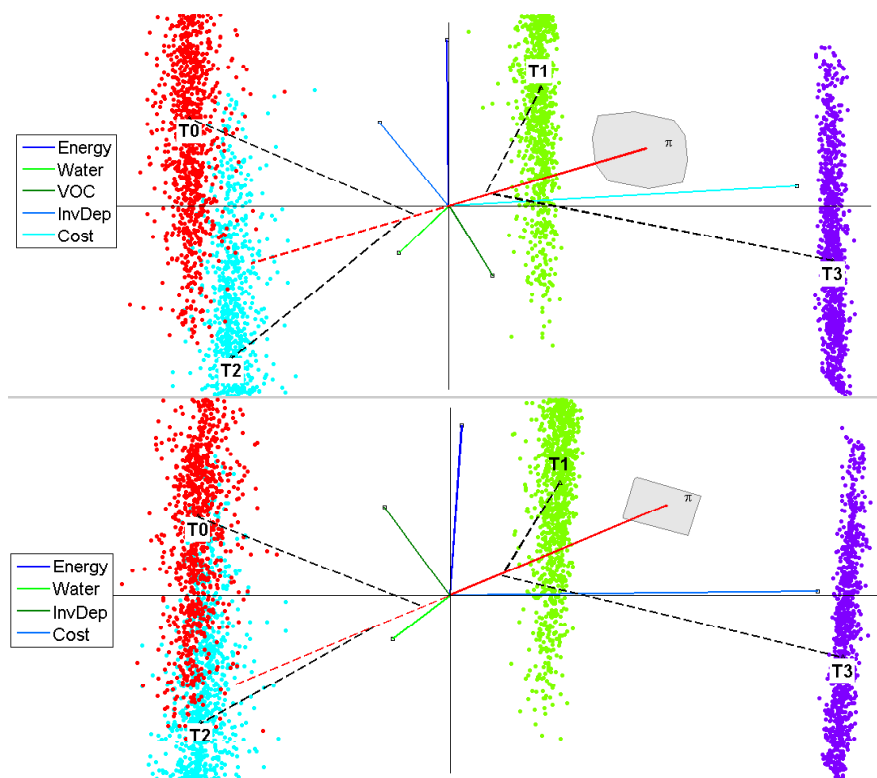


FIGURE 7: GAIA Plane of the full (upper) and abridged (lower) evaluation

## DISCUSSION AND CONCLUSIONS

This paper shows the application of the MOPA to the process of industrial coating of bicycle and bed frames. Target values of optimization as well as economically feasible operating parameters of certain techniques (e.g. condensation of VOC) are evaluated and calculated using pinch analysis for energy, water and VOC. The results of these analysis are aggregated to a distance measure which can be used for the comparison of the investigated alternatives.

Furthermore, the single parameters can be investigated by a multi-criteria analysis offering the possibility of carrying out several sensitivity analyses. They can provide a good understanding of the effects of the different modeling parameters. The use of a Monte Carlo Simulation offers the possibility of an analysis comprised of several parameters simultaneously. Consequently, the application of the Monte Carlo Simulation in combination with a Principal Component Analysis can help to understand the impact of the uncertainties of the value judgments on the overall results. Additionally, decision makers should be aware of the influence of the selected criteria and the chosen weighting factors as demonstrated by the rank reversal obtained in this case study due to the elimination of one criterion.

## REFERENCES

- Basson, L., 2004. Context, Compensation and Uncertainty in Environmental Decision Making, Ph. D Thesis, Department of Chemical Engineering, University of Sydney, Sydney.
- Brans, J.-P., Mareschal, B., 2005. PROMETHEE Methods, In: Figueira, J, Greco, S, Ehrgott, M (Eds.), Multiple Criteria Decision Analysis - State of the Art Surveys, Springer, New York, pp. 163-195.
- Brans, J.-P., Vincke, Ph., Mareschal, B., 1986. How to select and how to rank projects: The PROMETHEE method, European Journal of Operational Research 24, pp. 228-238.
- Cerda, J., Westerberg, A., Manson, D., Linnhoff, B., 1983. Minimum utility usage in heat exchanger network synthesis - A transportation problem, Chemical Engineering Science 38 (3), pp. 373-387.
- Dunn, R. F., El-Halwagi, M., 1994. Optimal design of multicomponent VOC-condensation systems, Journal of Hazardous Materials 38 (1), pp. 187-206.
- Geldermann, J., 2005. Optimisation beyond Best Available Techniques, In: Geldermann, J, Treitz, M, Schollenberger, H, Rentz, O (Eds.), Challenges for Industrial Production - Workshop of the PepOn Project: Integrated Process Design for Inter-Enterprise Plant Layout Planning of Dynamic Mass Flow Networks (XX), Universitätsverlag Karlsruhe, Karlsruhe, pp. 21-30.
- Parthasarathy, G., El-Halwagi, M., 2000. Optimum mass integration strategies for condensation and allocation of multicomponent VOCs, Chemical Engineering Science 55, pp. 881-895.
- Treitz, M., Schollenberger, H., Bertsch, V., Geldermann, J., Rentz, O., 2004. Process Design based on Operations Research: A Metric for Resource Efficiency, Clean Environment for All: 2nd International Conference on Environmental Concerns: Innovative Technologies and Management Options, Xiamen, P.R.China, pp. 842-853.

# THE OPTIMISATION OF THE PROCESS WATER USE IN INDUSTRY BY WATER PINCH ANALYSIS

Etienne Brauns, Inge Genné, Wim Schiettecatte, Joost Helsen  
VITO, Mol, Belgium

In industry, the cost of fresh water intake, wastewater treatment and effluent disposal is rising. Therefore the industry is interested in methods to optimise the use of process water. As a first step, an inventory (“water balance”) of the process water streams with respect to flow and contaminants level is made. Standard stand-alone graphical and solver software tools can be used to set up the inventory but dedicated and sophisticated software such as WaterTracker™ is also available. The inventory produces a list of influent and effluent process streams. An effluent could be considered to be a source (a “supplier”) while an influent could be considered to be a sink (a “consumer”). Therefore, in a second step the set of process streams is split into a set of sources and a set of sinks. Water pinch software (e.g. WaterPinch™) then optimises the process water use/reuse by looking for the most cost efficient combinations of sources and sinks.

## INTRODUCTION

Water is increasingly being considered as a costly base material in industry. Restrictions by legislation stimulate the companies to manage their fresh water consumption, waste water treatment methods and waste (water) disposal. Software based tools are available to optimise the use of water within a company or even within an industrial complex of companies, while maintaining the quality standards of production.

Water pinch can be used to optimise the process water consumption from the early design of a new company but the method can also be used in a retro-fit mode. In the latter case, an inventory of the water streams within the process water network with respect to their flow and contaminants level is made first. The water network is mostly rather complex and software tools are needed to produce the inventory of all water streams in an efficient way. Standard software tools exist for the graphical representation of the network while sophisticated solvers allow to calculate the mass and contaminant balances. Such solver software is able to calculate mass flow and contaminant levels of undetermined streams from the measured flow and contaminant data of a restricted number of selected streams. Next to the graphical and solver software which are used separately, sophisticated software such as WaterTracker™ from Linnhoff March enables to perform the graphical network visualization and solver tasks within one dedicated software tool.

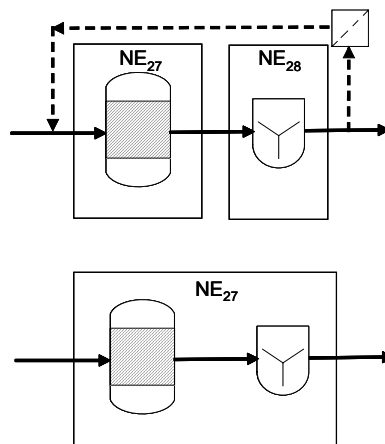
The inventory results in a list of influent and effluent process streams. Since an effluent from a specific process could have a sufficient mass flow and a sufficient process water quality to be used as an influent for another process, such an effluent is considered to be a source (a “supplier”). Also, an influent having a specified mass flow and minimal contaminant level specifications is considered to be a sink (a “consumer”). Water pinch software therefore considers, in an abstract way, the process streams as two sets : a set of sources (effluents) and a set of sinks (influent). Water pinch then optimises the process water consumption by looking for the most cost efficient combinations of specific sources, within the large set of sources, with specific sinks, within the large set of sinks. This combinatory problem is complex since a source and a sink should be compatible with respect to all specified contaminant levels. Moreover, the most cost-effective combinations should be selected by the evaluation of fixed and variable costs. The effect of relaxing inlet constraints and sensitivity analysis can be evalu-

ated. Bounds are also included since a number of source/sinks combinations are restricted from practical reasons (distance, maximum flow through existing piping, ...). Moreover, elaborated water pinch allows for the addition of unit operations which regenerate a source to a higher water quality. Adding regeneration processes within the water network in an economical way is the ultimate water pinch objective.

## INVENTORY OF THE PROCESS WATER NETWORK : THE NETWORKS MASS BALANCE AS A FIRST STEP

### A process water network and its process streams mass balance

In most cases the process water piping network in a company is rather complex. Moreover it occurs that the network evolved in a pragmatic way without detailed records. Except for the water intake locations, volume or flow meters are rarely implemented. As a result, the knowledge of the streams (flow values and contaminant levels) is often restricted. When initiating a water pinch study the first step is to make a complete inventory. Setting up an inventory requires an adequate and affordable methodology. The approach of elaborated mathematical modelling (e.g. based on sophisticated differential equations modelling whatever stream, process or water storage) is much too complex and expensive. In view of the objective of a water reuse study by water pinch, it is commonly accepted to restrict the water network model to an abstract but representative static network of process nodes, being interconnected by the process streams.



**FIGURE 1: Node concept : process node or process group node**

As illustrated in FIGURE 1 a node can represent in an abstract way one individual process but also a group of several processes. A process group node is used when stream changes are not allowed. A full representation of each process in the water network mass balance study would be redundant in such a case. From a modelling point of view the water network is thus represented by a set of nodes with virtual node boundaries and with water streams flowing from one specific node to another specific node. A further simplification is made by assuming those in- and out flowing streams to be “static” (non-fluctuating), thus each having an average flow and contaminants concentration level. Such a static approach clearly makes a rigorous and invasive abstraction from the actual dynamic character of the real network. However, such a concept of a nodes network as a static model is used in water pinch analysis since it is the only workable and economic approach in practice.

When dealing with the actual and dynamic water network at a factory, it is necessary to be creative by e.g. reconsidering a fluctuating flow from a water reservoir as a

“constant” flow by introducing a larger time interval (month, year) as a time basis and by introducing an “averaged steady” flow value as a typical value. Regarding water re-use studies by e.g. water pinch, this simplified approach is commonly accepted. Therefore a “static” approach of a nodes network, with stream flow values expressed as e.g. m<sup>3</sup>/month, allows for the extrapolation of the dynamic situation to an average static one. The measurement of the water mass flow of each individual stream would be unpractical and too expensive. It is therefore also assumed that the network can be “balanced” by considering each individual node to comply with the law of preservation of mass flow. Within each node, the sum of the water mass flow values for all ingoing streams is assumed to be equal to the sum of the water mass flow values for all outgoing streams :

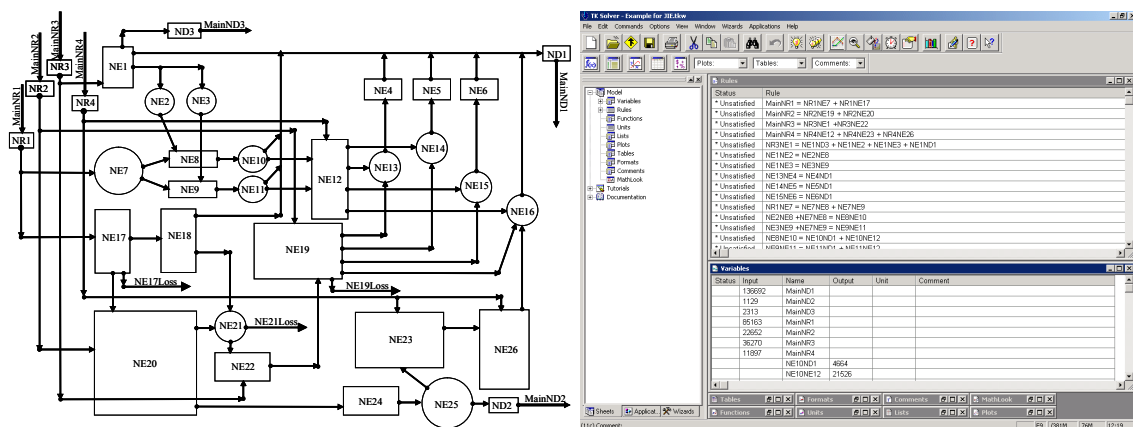
$$\sum_{All\ IN} Water\ mass\ flow\ STREAM_{IN} = \sum_{All\ OUT} Water\ mass\ flow\ STREAM_{OUT} \quad (1)$$

Such a mass balance equation can also be set up in each node for each contaminant. Since each node generates a set of mass balance equations, these sets of equations then can be solved for the process streams mass flows and contaminant levels. This is possible by general solver software or by dedicated software, as explained further.

**General software tools for setting up the “mass balance”**

With respect to the graphical visualisation of a process water network it is trivial to refer to software packages such as Microsoft Visio, Graphviz, SmartDraw, Conceptdraw, AutoCad or even Microsoft Powerpoint. Such software enables a fast representation of the process water network in whatever symbolic way, without the need for drawing every single pipe or process in detail.

With a definitive lay-out of the representative static network as a nodes network with interconnecting processtreams it is possible to write down all mass balance equations for each node as indicated by equation 1. Such equations can be handled by general solver software such as e.g. TK Solver (UTS). As an example of such an approach, a process water network is illustrated in FIGURE 2. The mass flow balance equations can be implemented in TK Solver, also shown in FIGURE 2. TK Solver has the interesting feature of indicating the degree of solvability after the input of a variables value. It is therefore possible, by the incremental introduction of a dummy flow value of “1” for selected process streams, to obtain a set of process streams which need to be measured in order to solve for the remaining unknown process streams. This allows for setting up a streams flow metering scheme at the start of the inventory study.



**FIGURE 2: Symbolic representation / mass flow equations in TK Solver**

It can also be remarked that TK Solver even allows for non-linear equations, which is not the case in the dedicated software tools such as WaterTracker™. The mass balance for a specific contaminant at a specific node therefore could be modelled mathematically in a more elaborated way in TK Solver.

### Dedicated software tools for setting up the “mass balance”

WaterTracker™ (LinnHoff March) is a dedicated and sophisticated software tool which allows for the immediate graphical drawing of the process water network on the computer screen. The software also solves the network since the node equations are formulated automatically when the network is drawn. The graphical features of WaterTracker™ are shown in FIGURE 3.

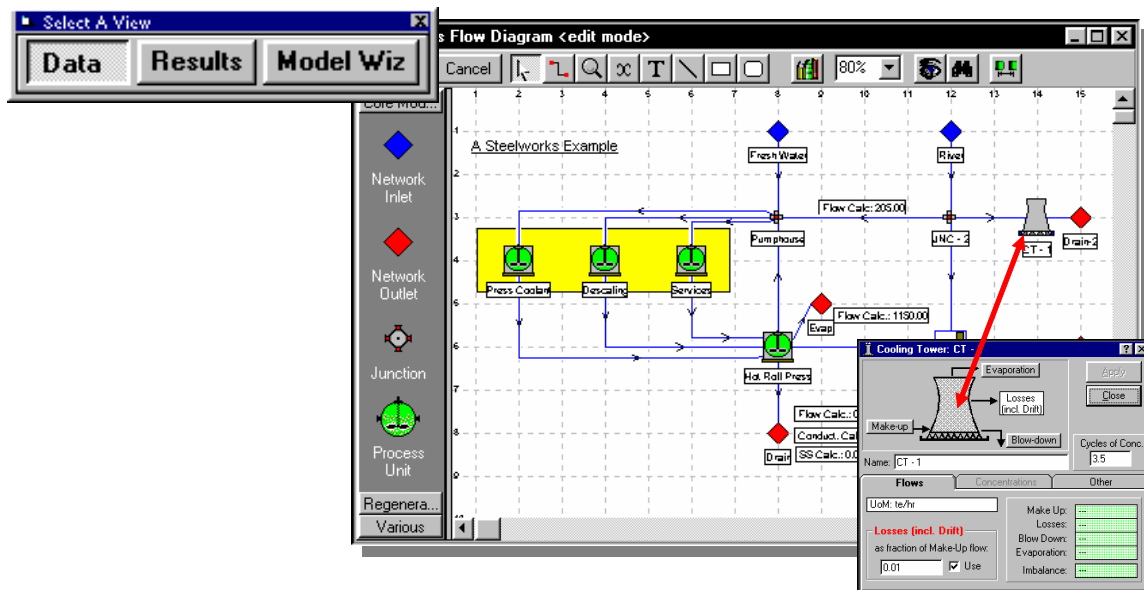


FIGURE 3: Graphical representation in WaterTracker™

When using WaterTracker™ it is also possible to set up a metering plan at the start of the water balance study. According to the metering plan the selected process streams are measured and sampled with respect to flow and purity.

## OPTIMIZATION OF WATER USE BY WATER PINCH, SECOND STEP

### Background of water pinch

The origin of water pinch is linked to the development of energy pinch which is a method to minimize energy consumption. Energy pinch was developed in 1970 at the department of Process Integration at the University of Manchester Institute of Science and Technology (UMIST). The pinch concept was then introduced with respect to the minimization of process water consumption. Water pinch fundamentals were developed by e.g. (El-Halwagi et al., 1992, 1995), (Smith et al., 1991, 1994, 1996), (Alva-Argáez et al., 1998) and (Wang & Smith, 1994, 1995).

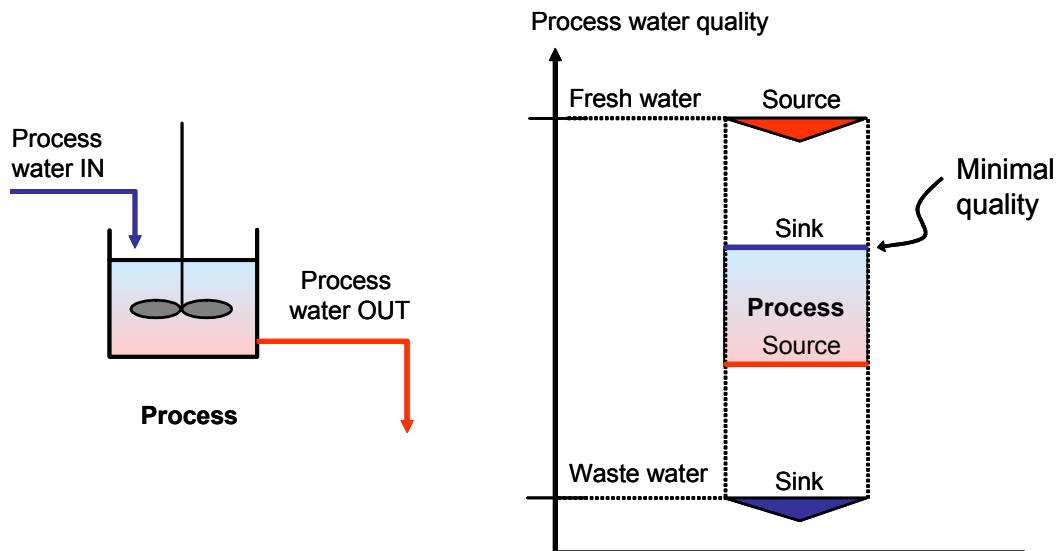


FIGURE 4: Sources and Sinks in WaterPinch™

As a result, a commercial software tool WaterTarget® was introduced by Linn-Hoff March (further called LHM ; a division of KBC Process Technology Ltd). WaterTarget® is a software suite comprising WaterTracker™ and WaterPinch™. The latter is the actual pinch software tool. The first package is a stand-alone software which enables to set up the water balance. WaterPinch™ is able to import the process water network data from WaterTracker™ (process water flows and contaminant concentrations water balance).

The definition of sources and sinks is important within water pinch. In principle, as illustrated in FIGURE 4, a process has one or more water streams flowing IN and one or more water stream(s) flowing OUT. Evidently, fresh water is a source and waste water is a sink. However, if the quality of the process water flowing out of a process A is sufficiently high (with or without additional treatment) to be used as a feed in another process B with lower quality requirements, the “waste” water OUT of process A is considered to be a candidate source for process B. In addition, the process water flowing into process B (stream IN) requires a minimal quality and is considered as a sink.

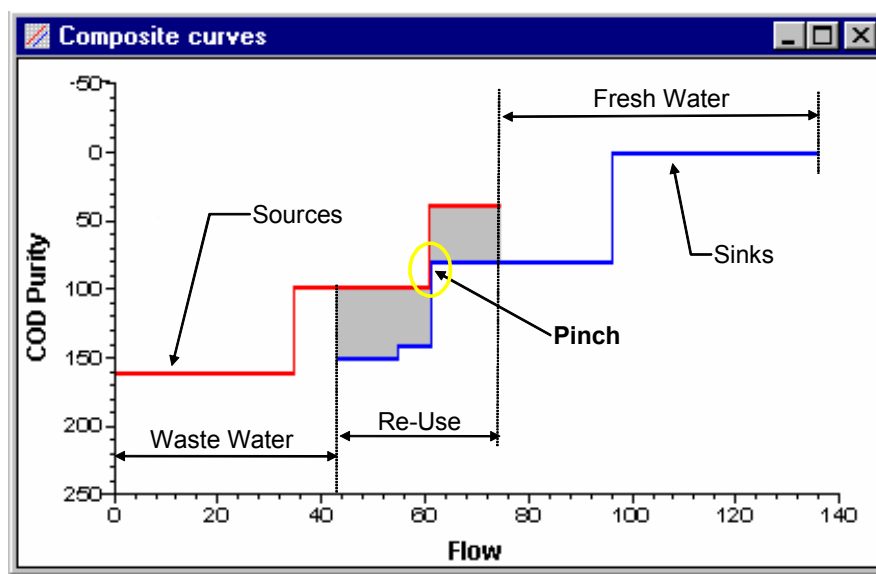


FIGURE 5: Composite curve and principle of water pinch in WaterPinch™

When finishing a water balance study, the inventory of in-flowing (sinks) and out-flowing process streams (sources) is available. For each individual contaminant the sinks and sources can be presented graphically in a composite curve as illustrated in FIGURE 5. Each source is represented as a horizontal line with its projected width corresponding to the flow value. Moreover, the sources are sorted by quality in ascending order. From an exact mathematical point of view it should be noted that the flow axis (X-axis) in FIGURE 5 therefore is in fact artificial since only the projected values are meaningful.

The vertical lines connecting the horizontal lines have no physical significance. In an analogous way, after sorting all sinks in an ascending quality order, the sinks can be represented as horizontal lines. After drawing both the sources and the sinks it is possible to shift the staircase type of sink curve until the staircase type of source curve is touched (pinch). From FIGURE 5 it is then obvious that :

- *the sinks which demand the highest process water quality can only be supplied with fresh water*
- *the flow and quality of a number of sources is sufficient in a way those sources can be considered as feeds for a number of sinks*
- *without treatment, the quality of a number of sources is insufficient to be further applied and therefore need to be considered as waste water (thus a source for the waste water sink)*

### Simplified combinatory approach

The composite curve representation already illustrates the complexity of a water pinch. Since there are mostly multiple contaminants to be considered, it is clear that each composite curve and its corresponding pinch position is different for each contaminant. Therefore, in a simplified approach, the water pinch can also be considered as a combinatory problem. In effect, FIGURE 6 shows an alternative graphical representation by projecting the sinks and sources of FIGURE 5 on the contaminant x-axis. Each source (So) which is positioned to the right of a sink (Si) has a higher water quality than the latter and is therefore a candidate as a feed for that sink. Also in such a graphical form, the flow value can be read in a correct mathematical way from the flow y-axis.

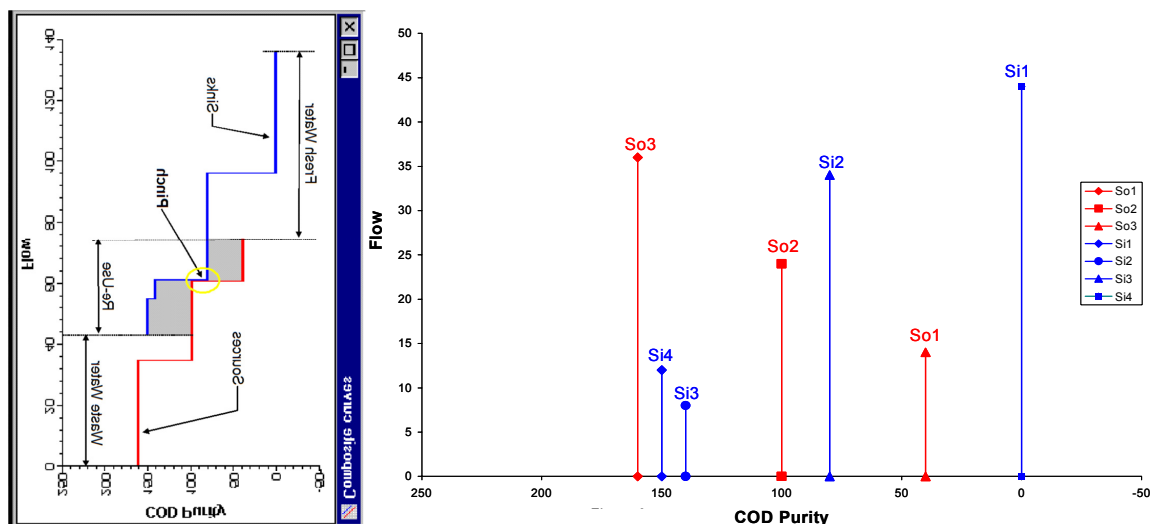


FIGURE 6: Combinatory presentation of the composite curve



With multiple contaminants and a large amount of sinks and sources, it is imperative to use software to solve such a combinatory problem. In FIGURE 7 an example is shown of a combinatory (low level) solving in Visual Basic. The program was written at VITO and is still at a very restricted  $\beta$ -version status for the moment. It is only used here for demonstration purposes. Only the sources inputs are shown in FIGURE 7 but the sinks inputs dialog windows are analogous.

The figure displays three windows from a Visual Basic application. The 'Sources' window has fields for 'Number of sources', 'Source index' (set to 1), 'Source name', 'Source flow (m³/h)', and 'Source temperature (°C)', with navigation buttons and an 'Input and next' button. The 'Contaminants concentration in the Sources' window has fields for 'Source Index' (set to 1), 'Source name', 'Contaminant index' (set to 1), 'Contaminant name', 'Contaminant concentration' (set to 0), and 'Concentration unit', with navigation buttons and an 'Input and next' button. The 'Selection' window shows a matrix of source-sink combinations with green and red cells, indicating viable and non-viable combinations respectively.

	Sink 1 (78)	Sink 2 (17)	Sink 3 (59)	Sink 4 (38)
Source 1 (150)	Green	Red	Green	Red
Source 2 (45)	Red	Red	Red	Red
Source 3 (83)	Red	Red	Red	Red
Source 4 (32)	Red	Red	Red	Red
Source 5 (150)	Green	Green	Green	Green

FIGURE 7: Example of combinatory low level solving in Visual Basic

After the input of data, the software looks for all possible candidates of source-sink combinations while respecting minimal sink quality specifications related to each contaminant. If one contaminant invokes a quality problem, the source-sink combination under investigation is discarded and the evaluation of the next combination is started. The resulting valuable combinations are shown in a sources-sinks matrix (as illustrated in FIGURE 7). Such a low level combinatory method is able to give a first indication of valuable candidates of source-sink combinations. This could already give a first insight in possible water reuse opportunities. However, a high level approach such as WaterPinch™, also incorporates advanced economical evaluations and the possible addition of water treatment unit operations. This is explained further.

#### Sophisticated approach by WaterTarget® from LinnHoff March (LHM)

A sophisticated water pinch analysis can be done through WaterPinch™ (Buehner & Rossiter, 1996) (Tainsh & Rudman, 1999) which is a stand alone software

tool within WaterTarget<sup>®</sup>. This software tool allows for both the sources and sinks data input by import from WaterTracker<sup>™</sup> or by manual input. As shown in FIGURE 8, a water pinch project can be defined in WaterTarget<sup>®</sup> through the Project Builder.

LHM considers process sources/sinks as having a fixed flow whereas utility sources/sinks can have a variable flow. The latter thus can have, next to the fixed costs, also variable costs. Fresh water e.g. as a source is a utility source since the flow is variable, a yearly fixed cost is charged by the fresh water supplier and a variable cost is linked to the variable consumption.

It should be noticed that the software does not handle a network but only considers in an abstract way a set of sources from which specific sources could be linked to specific sinks in the set of sinks. However, in order to allow for some operations to be defined, LHM also introduced unit operations in the software. Process unit operations have fixed in and out flows while utility unit operations have variable in and out flows. Both types enable to link outlet purities to inlet purities. WaterTarget<sup>®</sup> has some ready to use unit operations such as e.g. reverse osmosis, ion exchange, backwash filter, precipitator, air stripper and steam stripper.



FIGURE 8: Project Builder

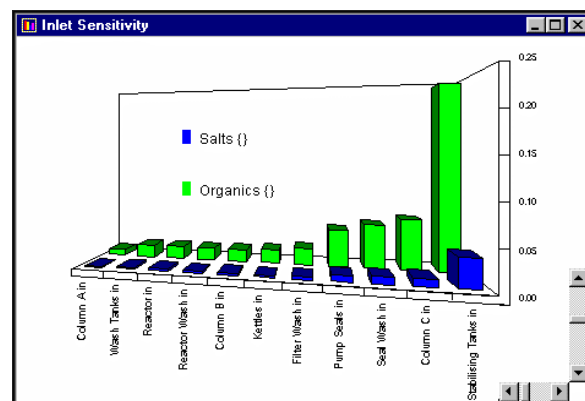


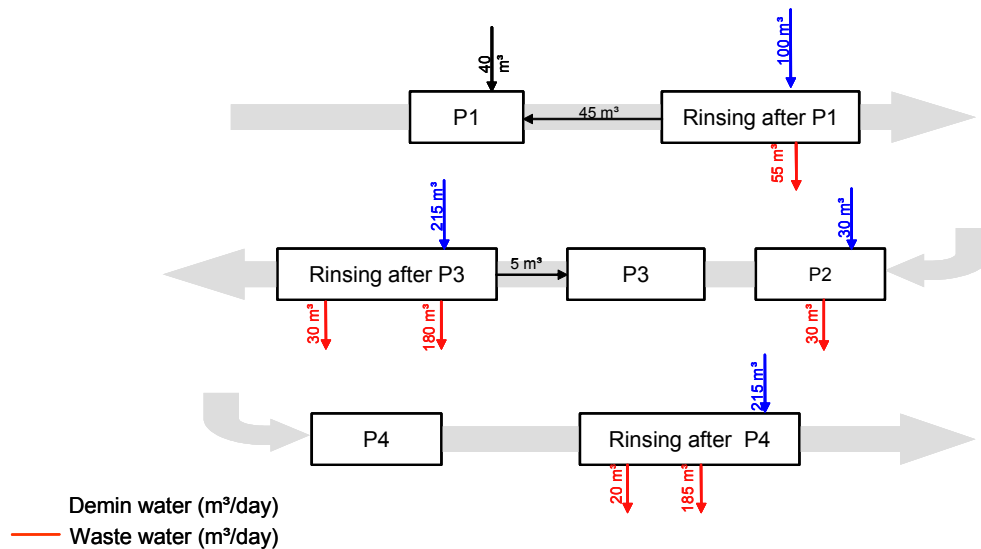
FIGURE 9: Inlet sensitivity

After the input of all sources and sinks data (eventually by importing from WaterTracker<sup>™</sup>) and defining process sources/sinks and utility sources/sinks the software is able to perform a water pinch analysis. The user is also able to implement unit operations e.g. for regeneration purposes as the ultimate strategy within the water reuse quest. Additional tools are available to the user to enhance the water pinch optimisation. A Bounds Editor allows to rule out specific source-sink combinations from the beginning (resulting from a large distance between both) or to set (upper or lower) boundary values for a specific source-sink combination with respect to flow. It is also possible to define the geographical positions of the sources or sinks in a way WaterTarget<sup>®</sup> can incorporate and estimate piping costs. A very important feature is the sensitivity analysis with respect to inlet relaxations. Such analysis evaluates the effect of lowering the purity specifications for sinks. As illustrated in FIGURE 11 the inlet sensitivity analysis allows to pinpoint the sinks which will yield a maximum profit when relaxing the purity specifications.

The ultimate result of the water pinch analysis is a list of optimal source/sink matches and an economic evaluation (benefits) of those water re-use opportunities. A roadmap for the implementation of the suggested solution is then possible.

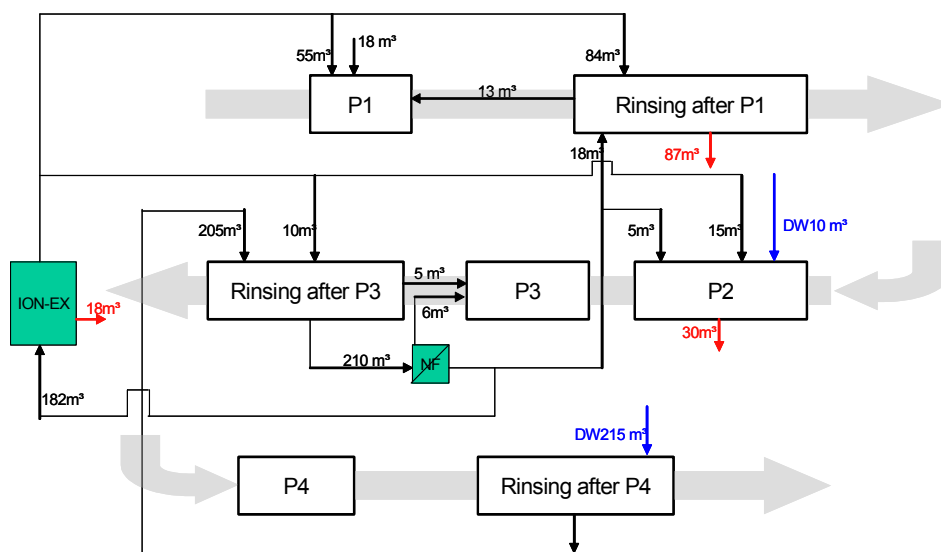
**A case study in the automotive industry**

In an automotive company, the surface treatment of the cars' bodyworks needed to be optimised, regarding water consumption. The surface treatment consists of 7 succeeding processes, 4 process baths and 3 rinsing steps (FIGURE 10). The main arrows indicate the production flow of the bodyworks. Two water types are available for each process : treated surface water (IW) and demineralised water (DW). Water consumption and discharge were studied for each process. In addition, the composition of the process effluents was examined with respect to four contaminants being regarded as important process parameters. The desired inlet concentrations of the different processes were also defined.



**FIGURE 10: Original situation at the painting section**

A first water pinch analysis did not consider regeneration techniques. The untreated effluents (sources) were matched with the influents (sinks) to find suitable source/sink combinations. In this scenario, the effluent of the rinsing step after P4 could be used to feed the rinsing step after P3. This, in fact, saves 205 m<sup>3</sup> of DW or 34 % of the initial amount of water. Still, 10 m<sup>3</sup> of DW needs to be added to meet the purity criteria for the rinsing step after P3.



**FIGURE 11: Adapted situation after water pinch**

In a second water pinch analysis, regeneration techniques were introduced to increase the purity of certain process effluents. Two techniques were selected : nanofiltration and ion-exchange. For both techniques standard removal ratios were given for each contaminant. Besides these 'regenerators' another water source was introduced : recuperated water, i.e. purified water from the waste water treatment. The use of recuperated water implied a decrease in the total discharge cost of the company. The use of this water type was obviously restricted to processes where water quality was not critical. The result is shown in FIGURE 11. The total amount of water is now decreased to 237m<sup>3</sup> per day, which is in fact a reduction of 60 % of the initial amount of water used in the surface treatment.

## CONCLUSION

Water pinch analysis, from a low level up to a sophisticated level, is supported by several software tools. An advanced and dedicated pinch software suit such as WaterTarget<sup>®</sup> allows for the graphical representation of the process water network and the calculation of the water balance. Based on these data, a water pinch analysis optimises water re-use . An economical evaluation is performed at the same time. In this way, important amounts of water could be saved. In addition to possible economical savings, the minimization of the water use by water pinch can significantly contribute to an environmentally sustainable water consumption by industry.

## REFERENCES

- Alva-Argáez A., A.C. Kokossis and R. Smith. 1998. An integrated design approach for waste water minimization : theory and applications. IchemE Research Event, Newcastle, 7-8 April
- Alva-Argáez A., A.C. Kokossis and R. Smith. 1998. Wastewater minimisation of industrial systems using an integrated approach, *Computers Chem. Eng.*, 22, 741-744
- Buehner F.W and A.P. Rossiter. 1996. Minimize waste by managing process design, *ACS ChemTech*, April, 64-72
- El-Halwagi M.M. 1992. Synthesis of reverse osmosis networks for waste minimization, *AIChEJ.*, 38(8), 1185
- El-Halwagi M.M. and C. Stanley. 1995. In Rossiter, A.P. (ed) *Waste minimization*, McGraw Hill, New York, 15-16
- Smith R. and E.A. Petela. 1991. Waste minimisation in the process industries : Part 1. The Problem, *The Chemical Engineer*, 506, 24-25
- Smith R. and E.A. Petela. 1991. Waste minimisation in the process industries : Part 2. Reactors, *The Chemical Engineer*, 509/510, 17-23
- Smith R., E.A. Petela and Y.P. Wang. 1994. Water water everywhere, *The Chemical Engineer*, 565, 21-24
- Smith R., E.A. Petela and J. Howells. 1996. Breaking a design philosophy, *The Chemical Engineer*, 606, 21-23
- Smith R. 1994. *WaterPinch*, in *Chemical Process Design*, McGraw Hill
- Tainsh R.A. and A.R. Rudman. 1999. Practical techniques and methods to develop an efficient water management strategy, Presented at IQPC Conference " Water Recycling and Effluent Re-Use", 26-27 April
- Wang Y.P. and R. Smith. 1994. Waste water minimisation, *Chem. Eng. Sci.*, 49, 981-1006
- Wang Y.P. and R. Smith. 1994. Design of distributed effluent treatment systems, *Chem. Eng. Sci.*, 49, 3127-3145
- Wang Y.P. and R. Smith. 1995. Waste water minimization with flow rate constraints, *Trans.I.Chem.E.*, 73(A), 889-904

## **CASE STUDY ON COATING PROCESS IN BEIJING AUTOMOBILE WORKS**

**Yinan Wang**

Institute of Energy, Beijing, China

Institute of Electrical Engineering, Chinese Academy of Sciences

**The coating workshop in Beijing Automobile Works has provided a typical example for the study of environmental impact. This case study includes systematic information of the workshop for the manufacturing process and the waster treatment.**

### **INTRODUCTION OF THE COMPANY**

Established in 1985, Beijing Automobile works was the second largest carmaker in China at that time. Later in 1987, it was incorporated with Beijing Motorcycle Works to form Beijing Automobile and Motorcycle United Company (BAM). In 2001, based on the modern structure, the company merged with Beijing assembly plant to set up a new limited company, Beijing Automobile Works Co., Ltd (BAW).

With a long history of manufacturing light off-road vehicles and trucks, BAW is now considered as one of the important automakers in Beijing. The business scope includes developing, producing and selling light off-road vehicles, trucks, and other special purpose vehicles.

BAW's headquarter in Chaoyang district, Beijing, has two separate plants in Chaoyang and in Shunyi districts. The annual capacity is about 100,000 units. The comprehensive distribution and service networks cover the whole Chinese market, including every provinces, cities and municipalities.

The company is mainly engaged in the designing, production and marketing of cross-country vehicles, business cars and special vehicles as well as refurbishing vehicles, and has more than 150 kinds of production lines. BAW becomes the appointed supplier for national military vehicles as well as the major manufacturer for light cross-country jeeps. Additionally, it has been listed as one of the four major companies in vehicle manufacturing in Beijing. BAW has established a complete network on marketing and after-sales servicing in China and been awarded the ISO9001-2000 and GJB9001-2000 quality certifications.

The company has three main product series, light off-road vehicle, pick-up truck and Sport Utility Vehicle, including Luba, Luling, Qiling, and Flagship (amphibian vehicle). These products are sold nationwide and exported to many other countries.

The photographs of the main products are shown in FIGURE 1.

## Trucks and



## Civilian SUV



**FIGURE 1: Main vehicles produced by BAW**

### INTRODUCTION OF SHUNYI PLANT

With an annual capacity of 50,000 units of vehicles, Shunyi Plant occupies 310,000 m<sup>2</sup> in area. The view of plant is shown in FIGURE 2.



**FIGURE 2: Partial view of Shunyi plant**

To reflect the general states of Shunyi plant, TABLE 1 summarized the yield and sales in the year of 2002 and 2003.

**TABLE 1: General information of Shunyi plant of BAW**

Year	2002	2003
Car Yield (Unit)	15345	20248
Car Sales (Unit)	14408	18603
Sales (Million Yuan)	873	1,517
Total Asset (Million Yuan)	253	490
After Tax Profit (Million Yuan)	10	12
Tax (Million Yuan)	34	69
Number of Employees	747	852
Yield Rate (K Yuan/Person)	1,168.7	1,781.1

The above table gives information for the past two years, however, the plant has the following targets for the coming years.

**TABLE 2: The techno-eco target (calculated by annual yield of 50,000 units)**

	List	Unit	quantity
1	production capacity	unit	50,000
	includes: light truck	unit	20,000
	Military light jeep	unit	8,000
	Civilian light jeep	unit	22,000
2	Occupied land area	m <sup>2</sup>	309,139
	includes: building area	m <sup>2</sup>	268,855
3	Total construction area	m <sup>2</sup>	104,046.5
4	Production equipments	set	553
5	Number of work force	person	1,150
6	Total investment	Million Yuan	279.17
7	Income for annual sales	Million Yuan	3,717.60
8	Annul cost	Million Yuan	3,269.47
9	Cash flow	Million Yuan	3,221.48
10	Tax including VAT	Million Yuan	291.95
11	Total profit	Million Yuan	156.18
12	Company income tax	Million Yuan	51.54
13	After tax profit	Million Yuan	104.64
14	Profit vs. investment	%	30.1
15	Tax vs. investment	%	86.2
16	Profit revenue	%	4.2

## **COATING WORKSHOP**

### **The structure of the workshop**

The coating workshop in Shunyi plant is constructed using light steel mesh enforced by brick wall at the bottom of 1.2 m in height. At the top of the wall there is compound thermal structure for the heat preservation. Furthermore, the roof is also made of the same material as of the wall. The roof top's fans are designed for air circulation.

The workshop's total area is 21744 m<sup>2</sup>, the height is 8.8 m, width of 24 m and 180m for the length. Daylight from the roof and the wall is combined with electricity light for the lighting.

### **Production Chart**

The task of this workshop is for the coating of vehicles including Luba, Luling, Qiling, and Flagship. The process consists of treatment prior coating, eletrophoresis, inner coating and surface coating. Two shifts' working is adopted to guarantee the production target of 50,000 units of vehicles.

The production chart is in FIGURE 3.



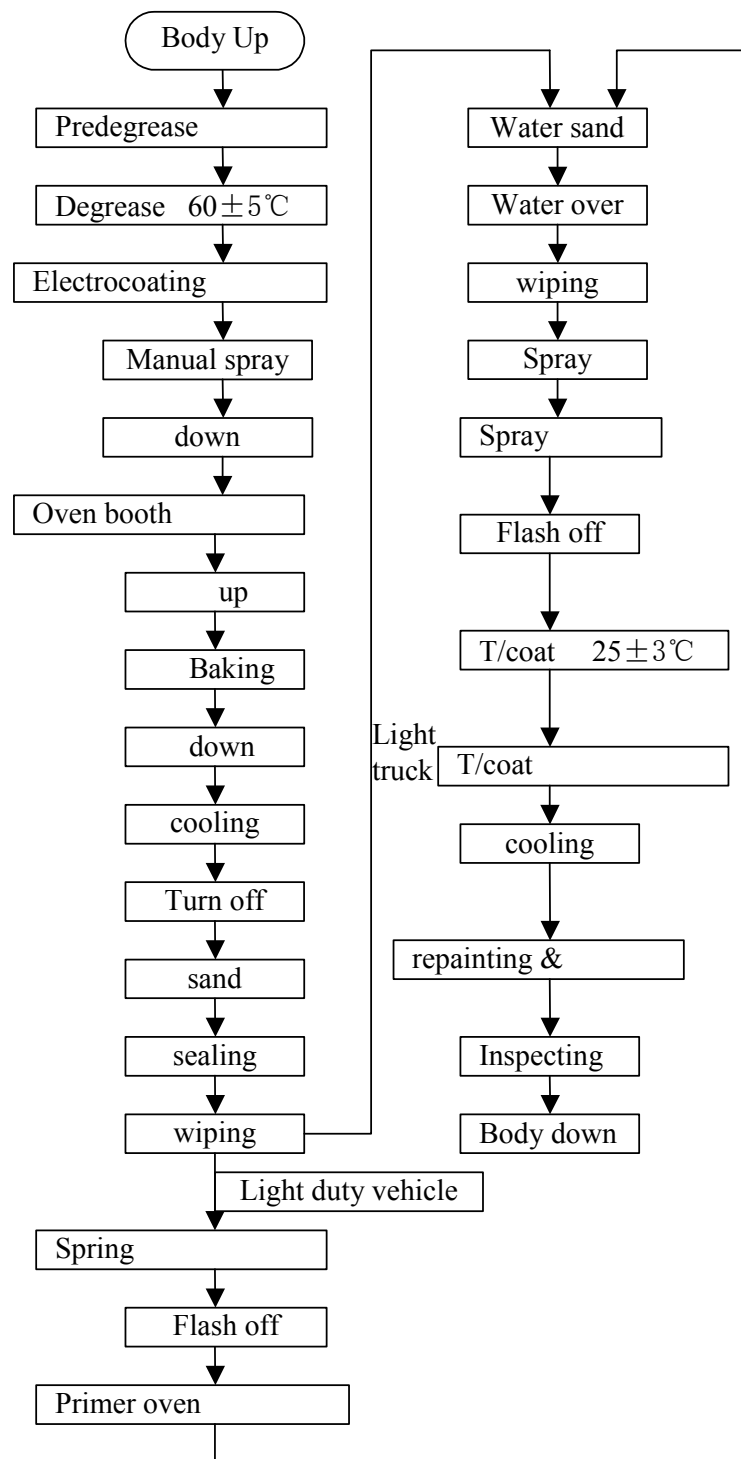


FIGURE 3: Coating Process Steps

## THE EFFLUENT TREATMENT OF THE COATING WORKSHOP

### The standards adopted in the effluent treatment

1. The standards for the treatment of polluted water in the city of Beijing
2. The standards for the air-pollution, GB16297-1996
3. The standards for noise pollution in the industry, GB12348-90
4. The standards for air pollution due to industrial oven, GB9078-1996

### Study of the pollution of the workshop

The pollution sources to the environment of this workshop are mainly: noise, effluent water, effluent gases and waste solid residues. The factory has applied the following measures for the treatments.

#### ▪ *Noise*

Precaution measures have been taken in the designing stage to minimize the noise. The requirements have been stressed for the noise reduction during equipment purchasing; the workshop has built-in isolation foundation and wall absorption boards; soft connections are used between the piping and equipment for the reduction of vibration; the heavy noised equipments, e.g., cooling pumps, chilling system, etc are installed in the enclosure of special rooms.

After the above measures, it has proved that the no.1 specification of the standards for the air-pollution, GB16297-1996 has been complied.

#### ▪ *Effluent water*

The effluent water is sourced from following production stages, degreasing prior coating, phosphorised process and final water cleansing.

The water testing results are: pH = 8-9; BOD<sub>5</sub> = 74mg/L; COD<sub>cr</sub> = 274mg/L SS = 73mg/L; mineral oil=16mg/L; Zn(Zinc and its inorganic compounds)=0.145mg/L.

The effluent water is drained to the waste water station in the factory. In this station, the water is treated by the method of "waste water-pH fitting-deposition-air floating-sand filtering". After this pre-treatment, the water is drained to sewerage system station located in the nearby area.

#### ▪ *Effluent gas*

The effluent gas is sourced from the polluted air produced by natural gas burning in the oven, polluted air due to the coating and polluted air expelled from dryer.

We have measured the smoke from chimney of the dryer and oven and the results are 7.6 mg/m<sup>3</sup>, SO<sub>2</sub>=17 mg/m<sup>3</sup>, NO<sub>x</sub>=168 mg/m, blackness of the dust is less than level 1.

It is confirmed that the air pollution of the coating workshop complies with the standards of DB11/139-2002 in Beijing area.

The special treatment has been taken for the air pollution produced by the coating process. The effluent gas is treated by water spraying using spinning method. The effectiveness of removing the painting dust may reach 98% or above. The treated gas is exhausted through a 25m chimney to the open. The treatment is complies with the relevant regulation.

The organic effluent gas produced from the dryers is lead to the oven to mix with natural gas for the burning. There is a 15m chimney for each dryer to exhaust the treated effluent gas in the chamber. The treatment is complies with the relevant regulation.

#### ▪ *About the solid residues*

The solid residues mainly consist of paint residues, phosphorous residues, used sand paper, used cotton wool, mud from sewerage station. Among them, phosphorous

residues and paint residues are collected to the solid residues treatment centre in Beijing for special treatment. The rest of the solid residues are treated through the normal standard channel.

**Investment for the environmental protection in the company**

4.77 Million Yuan of investment or 2% of the total investment of the company has so far used for the waste treatment.

**CONCLUSION**

The case study is conducted in the coating workshop of Beijing Automobile Works for the pollution sources. The analysis of the effluent gas, water and solid residues has confirmed that the treatment measures of the company have complied with the relevant national standards.



## **STUDY ON THE ECO- INDUSTRIAL MODEL FOR ALCOHOL DISTILLERY**

**Guo Surong, Yongsen Lu, Dahe Jiang, Cunkuan Bao**

College of Environmental Science and Engineering, Tongji University  
Shanghai, China

**In this paper the successful implementation of the cleaner production practised by Taicang Xintai Alcohol Distillery Co., Ltd., China (simplified as Xintai below) was investigated in detail. An innovative circular fitting for production pattern for alcohol distillery was built, though application of cleaner technologies, not only over 70% total amount of COD load in Taicang was cut down, but also sustainable benefits was brought about. The carbon element in the raw material was used effectively, and average 52% of energy was input from outside because energy from raw cassava were used in recycling and/or cascading ways. Based on the pattern, an eco-industrial model for alcohol production was propounded.**

### **INTRODUCTION**

Alcohol distillery is one of industrial sectors, which consumes great amount of water and energy. The average consumptions of a ton of 95% (v) alcohol are 102 tons of water and 217 kW.h of electricity. Meanwhile 10~15 tons of distillage (or wine/dreg) with COD as high as 50,000~60,000 mg/L are resulted.

Over the years the output of alcohol in China has increased rapidly. It was estimated that the output reached 5,000, 000 tons in 2004. It meant 50,000,000 ~ 75,000,000 tons of distillage was resulted. It would pollute water seriously if it were discharged directly; on contrary, it would be the resources if it were utilized.

In this paper how to prevent pollution and save energy in alcohol distillery is discussed. The achievements of this pattern revealed the importance to implement cleaner production and the principle of industrial ecology (Kim et al. (1997). Based on this case study an eco-industrial mode for alcohol distillery is suggested. It would promote the harmony between economy and environment.

### **PRACTICE OF CLEANER PRODUCTION**

#### **Background**

Xintai was established in 1994. Until 1998 it discharged lot of distillage directly into nearby Liu River. The amount of the effluent liquor shared 70% of the total amount of organic waste of all industrial sectors in Taicang. It began the processes innovation and distillage utilization project when the project on renovating Taihu Drainage area was launched in early 1998 by SEPA. At first it only paid attention to reduce wastewater pollution and avoid penalty. Later it found that profit could be made from the full utilization of distillage and waste. Then the installation for environmental protection has been focused on cleaner production consciously. Now it has been larger, more competitive, and the excellent example of environmental protection in Taicang. In 2003 it produced 45,000 tons of alcohol in different grades, 20,000 tons of by-product CO<sub>2</sub>, and 13million cubic meters of biogas.

### Circular pattern

One of the essential of cleaner production is 3R, i.e. reduction, recycle and reuse of materials and energy (Qian, 2004). Being contrary to linear material-flow of the conventional process, i.e. 'resource consumption → product → waste discharge', the *recycling* material-flow of the circular pattern is closed with the feedback as 'resource consumption → product → regenerative resource'. In another way, it is an integrated process that includes both production and consumption in all levels of the society, enforcing laws and regulations and emphasizing to use kinds of advanced techniques. To combine 3R principles with alcohol production Xintai has performed a creative production pattern with marked characters.

- *Compliance with laws and regulations on environmental protection*

Since the last two decades a series of laws and regulations have been enacted, and played two roles in environmental protection (Wang, 2004). On the one hand they put the pressure on enterprises; on the other hand they enhance the competitiveness and large the market opportunities for enterprises that have done well in environmental protection for variety of reasons: benefited from preference polices of getting loans in low interest and derating sales tax; the appreciation and encouragement from society and government to gain advantages over competitors though improving environmental performances, and to protect and enhance their reputation. Xintai has taken the advantage of all the supports of available environmental polices since 1998. Step by step it has changed its image from a serious polluter into an environmental friend, and won a great deal of recognitions from its customers and the society. Recently it has not only sold more products but also won more appreciations.

- *Integrated use of the Best Available Techniques (BATs)*

It is well known that technological advancement is one of the pillar stones of cleaner production to improve manufacturing processes and to save materials and energy. Without the support of technology enterprises would be difficult in pollution abatement. What severe laws could do is to force them to 'close, stop, merge, and shift' but couldn't eliminate real pollution. Unfortunately such measures would go against the original intention of lawmakers, because these measures would result unemployment and effect people's livelihood and social stability. In fact, people are in urgent need of both products and jobs.

So how to keep the balance between profit and environment became the tough task if Xintai tried to survive. In consultation with many scholars and institutes all over China, it decided to apply several BATs recommended by governmental institutions to increase efficiency and prevent pollution.

1. BATs one:

In the case study, it built up a distillage utilization and wastewater treatment consisting of two steps of UASB and SBR. UASB, the step one, was used to ferment organic compounds in distillage into biogas and decrease COD from 50,000 mg/L to 2,000 mg/L; and SBR, the steps two further reduce COD to less than 150mg/L, which meets the local secondary effluent standards. Optimising the reaction parameters, it yields 33m<sup>3</sup> biogas per cubic meter of distillage, much higher than the average amount of 23m<sup>3</sup>/m<sup>3</sup> in China (Xia et al., 1999). Now this integrated mode of combining UASB and SBR to treat distillage and mixed wastewater becomes the demonstration project, and more and more other alcohol enterprises learned from it.

2. BATs two:

The fermentation level was improved by using more effective yeast to increase the concentration of alcohol in the fermented liquid from 7.5 %(v/v) to 10.5 %(v/v). In this way 25% distillage was reduced, and roughly 38,000 tons vapor (P=0.25MPa, abs,

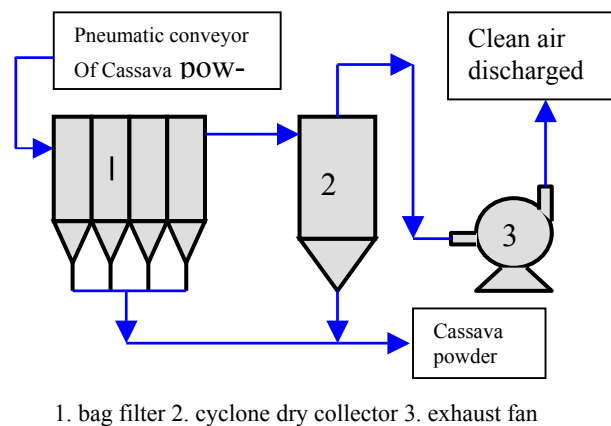
T=280°C) was saved because the feedstock of the distillation process was decreased sharply; and the investment could be reduced because the sizes of the distilling towers and other auxiliaries were reduced. In addition, the distillate load of UASB-SBR system was reduced from 580,000 to 400,000 tons. It showed that reducing pollution at the pipe-of-beginning but not -of end is the best choice.

### 3. BATs three:

The cogeneration has been used in Xintai that brought about remarkable energy savings in comparison with the system producing electricity and vapor separately. The cogeneration saved 25% ~ 30% of energy in comparison to a conventional process (Gorsšek and Glavič, 2003), and the energy efficiency of boiler increased 60% ~ 80% (Castier and Pajagopal, 1988). According to local statistics about 10,000 t/a of coal were saved.

### 4. BATs four:

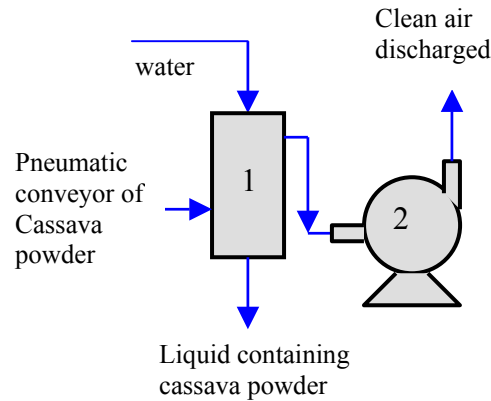
There are several methods to remove the particles in gas. In alcohol distillery the dry process, showed in figure 1, was usually applied to separate the cassava powder from gas, and then to brew it with water in the ratio of 1:3 (wt/wt)



**FIGURE 1: Dry process for separating Cassava powder from pneumatic-conveyor gas**

A wet method, showed in figure 2, was used to collect the cassava powder directly by water!

It is easy to find out that the wet process was much better than dry process in this situation. The defect of wet method was causing secondary pollution from wastewater, so that the dry methods has still dominated separating solid from gas. The innovative wet process made cassava powder absorbed by water for cooking, and the discharged air was cleaner. In addition, the power of exhaust fan was much less and the cost was much less.



1. water-film-shower tower 2. exhaust fan

**FIGURE 2: Innovative wet process for separating cassava powder from pneumatic-conveyor gas**

#### 5. BATs five:

The type of heat exchangers were changed from showering to helix-plate so that two flows in the helix-plate heat exchanger always flowed adversely in turbulent status when the number of Reynolds reached or higher than 1800. Comparison to direct showing type, the later needed less cooling water to exchange the same thermal energy and much easier to recycle and reuse the used-up cooling water. The transport power to transfer cooling water was also reduced.

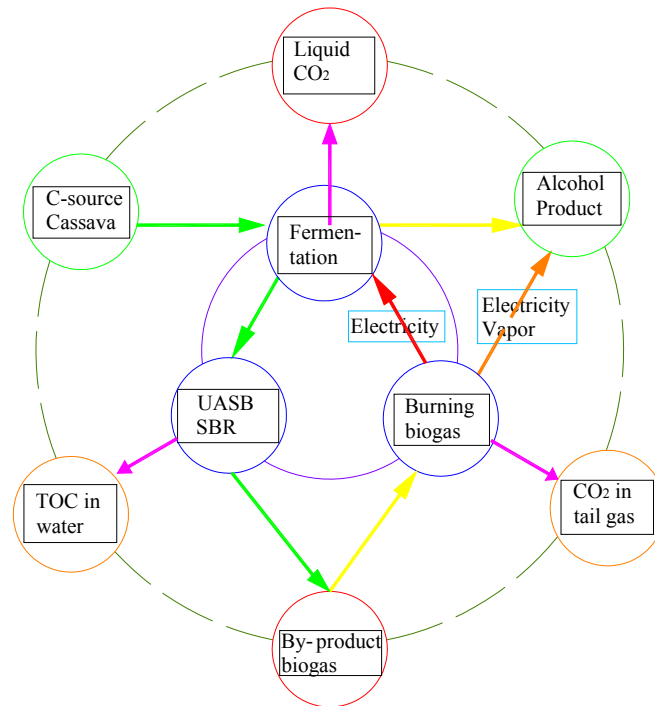
Most of the BATs are not the newest technologies and have been effectively used in other sectors, but they are newly used in alcohol distillery. Xintai's success proved the importance to take advantages of domestic best available techniques for a specific industrial sector.

- *Integration of mass and energy inner enterprise*

##### 1. Integrated use of cassava as the sources of mass and energy

It is well known that only small part of carbon in cassava are transformed into alcohol, and most of carbon is changed into various kinds of organic substances and remained in the distillage (Saha et al., 2005). But in Xintai the carbon in distillage were reused and most of the carbon was changed into biogas, and which was burned in furnace to generate electricity and vapor. Figure 2 presented the circular process of carbon substances.



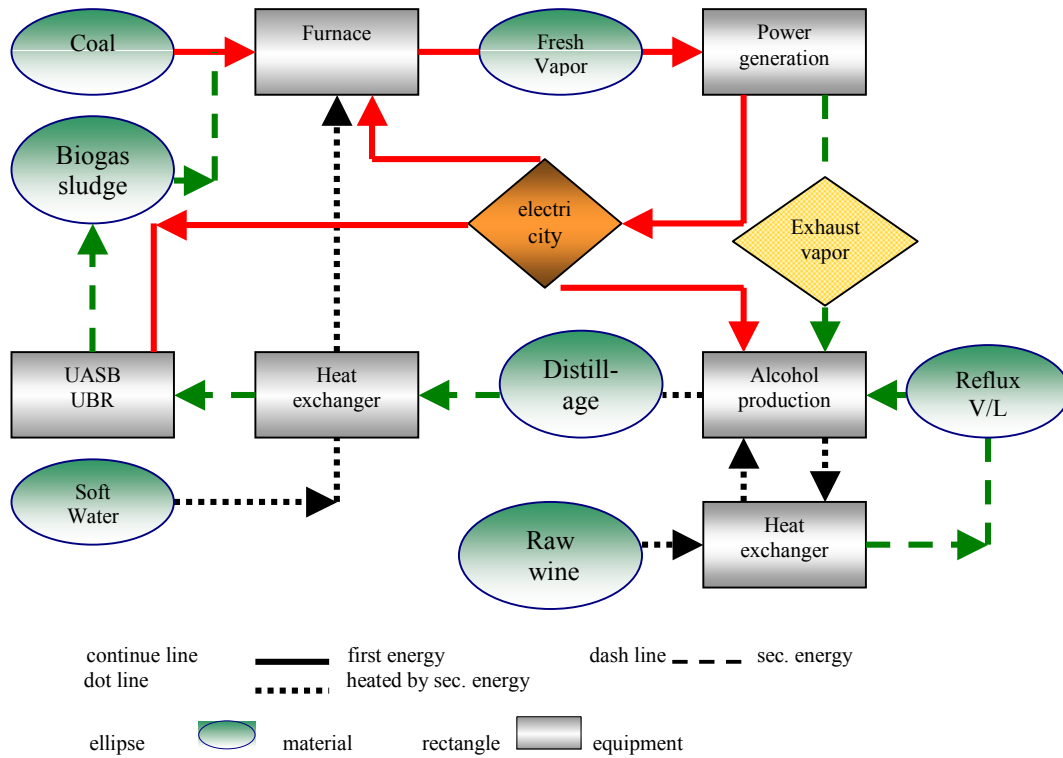


**FIGURE 3. Carbon Substances in cassava as the sources of mass and energy inner circle--- intra- alcohol distillery, outer circle--- trans- other enterprise**

## 2. Energy Cascading

An energy cascading system (EMCENTRE, 1993) was built in Xintai based on exergy levels of the resources (Gaggioli et al. 1991). In the cogeneration system (refer to BATs three), the high pressure and superheated vapor ( $P \approx 2.6 \text{ Mpa abs}$ ,  $T \approx 480^\circ \text{C}$ ) was used to generate electricity. The exergy of tail vapor ( $P \approx 0.453 \text{ Mpa}$ ,  $T \approx 300^\circ \text{C}$ ) was used in the process of cooking ( $P \approx 0.45 \text{ Mpa abs}$ ,  $T \approx 280^\circ \text{C}$ ) and distillation ( $P \approx 0.25 \text{ MPa abs}$ ,  $T \approx 260^\circ \text{C}$ ).

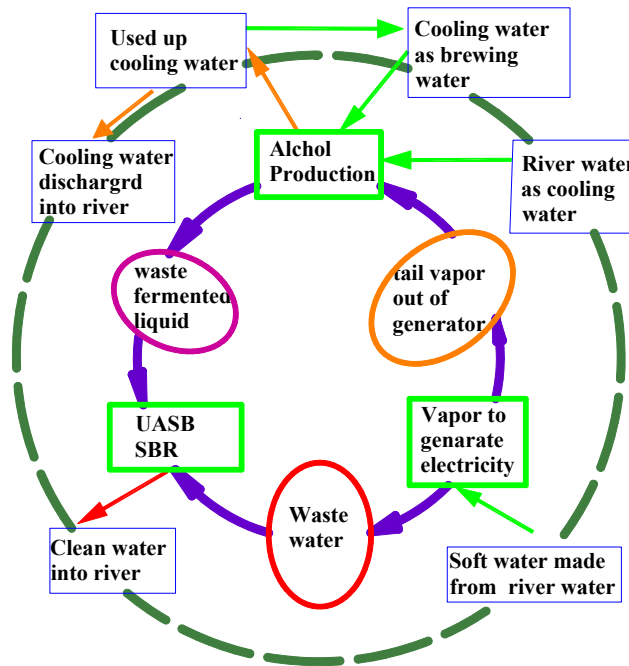
In addition, the thermal energy of vapor on the top of the distillation tower was used to heat the feed of the stripping tower. A part of cooling water ( $70^\circ \text{C}$ ) was used as brewing water. In this way not only the water but also its exergy was used. In the process of fermentation, cooling water ( $< 17^\circ \text{C}$ ) from underground was firstly used in fermentation ( $T \approx 33^\circ \text{C}$ ), and then continually used in saccharification ( $T \approx 65^\circ \text{C}$ ). The distillage ( $\approx 80^\circ \text{C}$ ) was used to heat the soft water before UASB-SBR system. The energy cascading system made a great amount of energy from heating and cooling process saved, as showed in figure 4.



**FIGURE 4: Energy Cascading according to the exergy level**

3. Water circle and integration

Xintai made a great achievement of water integration (EnviroNet Australia) by designing the water-net showed in Fig. 5, in which the inner circle was within the enterprise, and the outer circle was link to the Liuhe River



**FIGURE 5. Water integration between Xintai and the Liuhe River inner circle--- Xintai, outer circle--- the Liu River**

First, the river was the sink of the wastewater after treatment. Second, the cooling water was pumped directly from the river and discharged into the river again with two or three degree of temperature increment. Owing to the circular pattern and cleaner production, the Liu River has sufficient assimilation capability to tolerate small pollution loads from Xintai based on impact assessment. The river water was also used directly as process water, e.g. boiler water after ion exchange treatment. Small part of cooling water was used as brewing water (ref. 2.2.3.2) that saved not only tap water but also energy.

Making a comprehensive survey it was easy to find that all of natural resources, including Cassava, energy and water were full used, almost reaching the goal of 'zero discharge' (Ali, 2002).

## RESULT AND CONCLUSION

### Results

As compared with the similar distilleries in China, Xintai's main indicators reached or exceeded the advanced levels of alcohol distilleries in China, as showed in Table 1.

**TABLE 1: Comparison of the main indicators of alcohol enterprises  
(Using cassava as raw material (Huang et al. 2001))**

Types of enterprises	Input per ton alcohol				Discharged wastes Kg /per ton alcohol		
	Cassava Kg	coal Kg	Elec. kW.h	water m <sup>3</sup>	COD	BOD	SS
<b>Best level</b>	2640	450	178	50	119	63	30
<b>Average level of large and medium size firms</b>	2778	708	217	95	368	183	89
<b>Average level of small size firms</b>	2924	1459	307	125	576	237	140
<b>Xintai</b>	2917	400	165.8	70	2.64	1.32	1.76

Notes:

*Large and medium size firms denote the output more than or equal to 20,000 tons alcohol annually;  
Small size firms were those whose outputs were less than or equal to 5000 tons alcohol/ a;*

According to the classification, Xintai belonged to the type of large and medium firms.

### Conclusions

From Table1 it is obvious to find out that the indicators of coal and electricity input, and waste discharge reach or exceed 'the best level' in the country, but those of cassava and water consumption are not advanced, and it will discuss below.

- *Integrations of mass, energy and water.*

This integration is the pile stone of circular economy. With the help of the circular production pattern, it is possible for alcohol distillery to change the conventional linear economy into a closed loop of circular economy.

- *Set up a good show mode for alcohol distillery*

If all of alcohol enterprises in China implement the similar pattern, water environment would be improved immensely, because the total volumes of COD and BOD discharged by alcohol distillery in the country share respectively 18.0% and 12.5% volumes of all kinds of industrial sectors (Guo et al. 2004).

- *Optimization of multiple objectives.*

Table 1 showed that the indicator of the cassava input in Xintai was not as good as average level, but that of coal input was much better. Because the concentration of starch in the raw material used in Xintai was much lower than those counted in Table 1. In table 1 the cassava was denoted the cassava that contains about 65% starch. But in our case study, the raw material was the mixture of cassava and cassava residue from which the starch was extracted. On the one hand, it really increased the consumption of water and steam; but on the other hand, it was helpful to increase the level of fermentation of fibre, and to bring more biogas from distillage. The extra biogas and energy cascading of cogeneration compensated the extra consumption of steam. Xintai's experience reminded us of the importance of optimisation of multiple objectives.

## REFERENCES

- Ali, S. (2002). Move towards a zero liquid discharge distillery. In: Proceedings of the Second FICCI-TERI Global Conference: Green-2002 Agenda for Industry. 7-8 February 2002, New Delhi, India.
- Castier, M., and Pajagopal, k. (1988). Thermodynamic analysis of an distillery, Energy, 13, 455-459
- EMCENTRE (Environmental Management Center). Saving water, Energy and Raw Materials in Fermentation, in China, <http://www.emcentre.com/unepweb/tec case/food 15/house/casename.shtml>
- EnviroNet Australia. Recycling Waste Products from Molasses Fermentation, CSR Distilleries. <http://www.p2pays.org/ref/04/03358.htm>
- Gaggioli, R. A., Sama, D. A., Quian, S., and El-Sayed, Y. M. (1991). Integration of a new process into an existing site: a case study in the application of exergy analysis, Journal of Engineering for Gas Turbine and Power, 113,170 -183
- Gorsék, A, and Glavič, P. (2003). Process integration of a steam turbine, Applied Thermal Engineering, 23, 1227-1234
- Guo, H. C., Chen, B., Yu, X. L., Huang, G. H., Liu, L., and Nie, X. H. (2004). Assessment of cleaner production for alcohol industry of China: a study in the Shouguang Alcohol Factory, Journal of Cleaner Production. 12(9), 1-10
- Huang, J. H., Li, Q., Pan, Y. M., and Tian, K. (2001). Scenario Analysis on cleaner production of Alcohol, Environment in North China, (3), 18-21
- Kim, J. S., Kim, B. G., Lee, C. H., et al. (1997). Development of clean technology in alcohol fermentation industry, J. Cleaner Production, 5(4), 263-267
- Qian, Y. (2004). Cleaner production and Circular Economy-new Strategy for Environment and Development [A], In: China Association for Science and Technology. Proceedings of the world Engineer's Convention 2004, Vol. D Environment production and Disaster Mitigation [C]. Beijing: China Science and Technology Press, 2004. 215-218
- Saha, N. K., Balakrishnan, M., and Batra, V. S. (2005). Improving industrial water use: case study for an Indian distillery, Resources, Conservation and Recycling, 43, 163-174
- Wang, Y. Q. (2004). How to promote development of Circular Economy environmental Protection Department, Environment Protection, (9), 3-7
- Xia, C. F., Zhang, W. D., Song, H. C., Xie, J., and Zhao, Z. H. (1999). The Technological&Economic and Environmental Assessment of Biogas Engineering in Chinese Distillery, New Energy, 21(3), 35-40

# ASSESSMENT OF CHEMICAL PRODUCTION CONCEPTS IN PROCESS DESIGN

**Krisztina Cziner, Markku Hurme**

Helsinki University of Technology

Plant Design, P.O. Box 6100, FIN-02015 TKK, Finland

**An assessment approach is presented for comparing process concepts in an integrated multicriteria environment especially at early design phases. The method contains the consideration of company priority settings, selection of comprehensive set of criteria, scope definition, consideration of lifecycle and uncertainty aspects, and multiple criteria decision making. The aim of the method is to answer to the requirements of the changing engineering and business environment, where processes are more integrated and sustainability criteria need to be included in the evaluations. Finally, a case study on methyl methacrylate process concept selection is presented. Conclusions on process evaluation and decision making are given.**

## INTRODUCTION

The aim of process design is to create a process that is economic, safe, and environmentally benign throughout the whole lifetime of the plant. The complexity of process plants is increasing all time due to integration and more sophisticated process concepts and automation. Therefore the process design and related decision making is becoming more and more demanding. Typically multiple design goals are to be met, since profitability is not the only criterion considered today. Development of new products and technologies has to take place in a shorter time than before leading to integration of research, development and design steps. This development increases pressure on implementing new methods and integrating functions in engineering, business and management – areas, which used to be much of separate disciplines. Also the routines of design and decision making methods need to be modified for the changing engineering and business environment.

The aim of the paper is to present an approach for comparing process alternatives in an integrated multicriteria environment, which would answer to the requirements of the new engineering environment.

## SUSTAINABILITY AND PROCESS INTEGRATION

Sustainability is one of the major forces affecting process industry in the future. It is often defined as ‘meeting the needs of the present without compromising the ability of future generations to meet their own needs’. A generally accepted division of sustainability is to divide it into 1) economic, 2) environmental and 3) social sustainability. There also exist worldwide programs to enhance sustainability in industry such as the Responsible Care program in chemical industry. The participants of this program are committed to sustainability and improvement of operation by considering safety, health, environmental (SHE), and social aspects. Therefore these evaluations need to be included in all the business and engineering operations in an integral way.

Process integration (PI) is a way of implementing sustainable principles through reuse of materials and utilities. The traditional process integration developed in 1970's dealt only with heat integration. Later also mass integration came into picture through analogies with heat transfer. Nowadays PI can be understood in several ways:

- 1) Integrating (i.e. reusing) heat and mass streams in a plant, a site or community.
- 2) Manufacturing chemicals needed on a site locally (onsite integration).
- 3) In business literature; integration of business and manufacturing processes

Process integration has lately been defined also very widely as ‘design, operation and management of industrial processes with system-oriented and integrated methods, models and tools’. This definition covers in addition to material, energy flows also information streams of the plant as well as the business and technical processes during the whole life cycle of the plant from process development to plant retrofit. This wider definition of PI is called *comprehensive process integration* (Hurme and Tuomaala, 2003). It deals with integration of 1) different company *functions* such as (management, business, engineering and operation), 2) geographic *areas* (different units and plant and society) and 3) balancing of material and energy i.e. *raw materials* and *utilities* to optimize plant performance according to company strategic goals over the value chain.

## DESIGN CYCLE

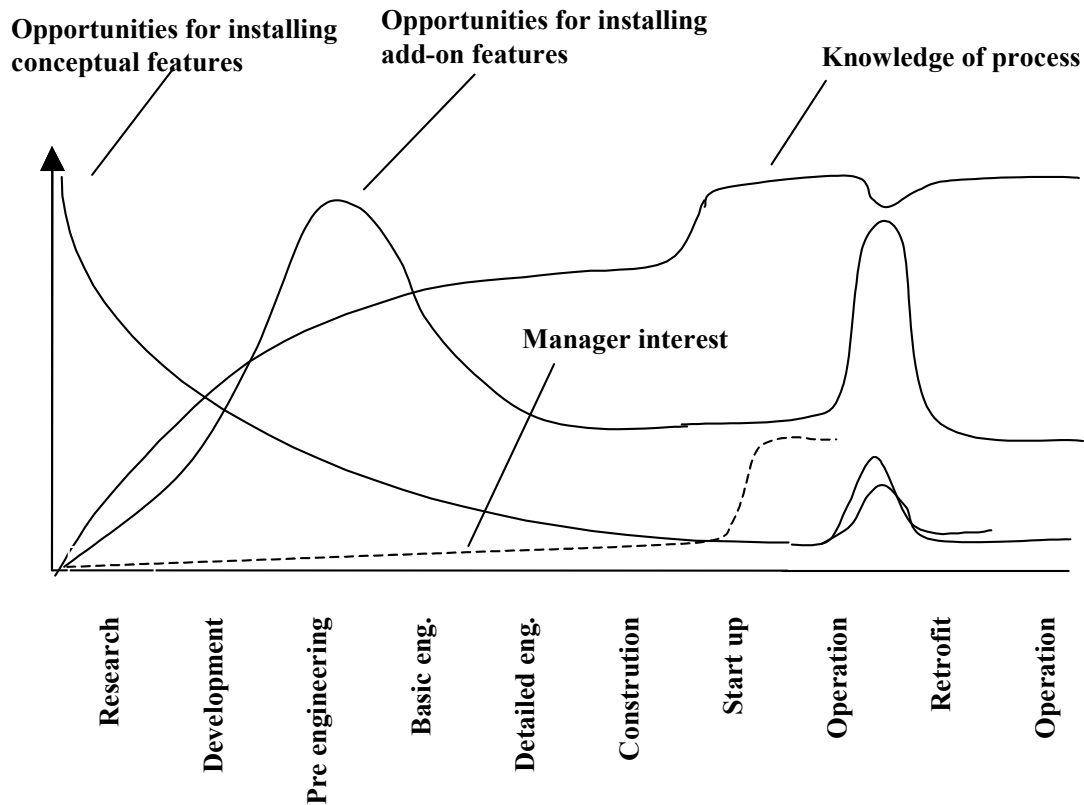
In a design project the main technical principle of a chemical process is selected in a very early phase. At this stage there is available only limited information on the engineering and economic details. Therefore the evaluation is based only on incomplete and partly inexact information. The *design paradox* is that in the conceptual phase there are many degrees of freedom to make choices, but for this there is only limited information available. Later in the project, when the process is well known, there are no possibilities any more to make large changes, except in retrofits, which come years later (Figure 1). Because the major decisions are made in the first design phases, there is a large motivation to improve evaluation and decision making in these phases.

A process goes through various stages of evolution. The typical design and decision steps phases are the following (Table 1):

In the *idea phase* the first check of the viability of a new idea is often done quite quickly. If the idea looks promising in economic and SHE terms, preliminary research and development can be started by a research decision.

In *research and development phase* the chemical and physical background and phenomena of process are cleared either from literature or by experimenting. The main aspects are often the study of the chemical reaction steps and subsequent product separation systems. In this phase bench and pilot experiments may be necessary for scale-up. Nowadays also mini plants are used to allow continuous process testing in small scale. In R&D phase, which includes also conceptual tasks, the designer has the greatest opportunity to implement improvements related to main principles, since major decisions are done here.

*Preliminary engineering* (or process predesign) is often done only for one or two most promising process alternatives. Material and heat balances for the process concept are calculated and flowsheet diagrams generated. For this purpose the type of unit operations have to be decided, if not already done in process development. Preliminary sizing of main equipment and a preliminary layout is also done. More accurate estimations of cost and profitability, safety and environmental aspects are made in a feasibility study to find out, if the project is still promising. Even the operating conditions of key operations are partly determined already in process development, there are still good opportunities to process changes for example by applying process integration and intensification.



**FIGURE 1: Process lifecycle and opportunities of installing conceptual and added-on features**

**TABLE 1: The design steps, process lifecycle and major decision steps**

---

1. Idea	- R&D-Decision
2. Research and Development	
3. Preliminary process design (pre engineering)	- Design decision
4. Basic engineering	- Investment Decision
5. Detailed engineering (plant engineering)	
6. Procurement, fabrication, construction, installation	- Start-up decision
7. Start-Up	
8. Operation, maintenance	- Retrofit decision
9. Modifications, retrofitting	- Closure decision
10. Decommissioning	

---

A plant construction project starts with *basic engineering*. The main task is to make the piping and instrumentation diagrams. All process data for equipment is defined. Automation designers make the basic definition of the automation system. Possibilities to conceptual changes are small and the design concentrates on process details and added-on systems.

The degrees of freedom to make changes are coming smaller and smaller in the following steps: *detailed engineering*, *construction*, *start-up* and *operation*. However the actions in *retrofit* phase resemble much those in process and detailed engineering phase. In the retrofit it is also possible to install new add-on features and even too make some conceptual changes (Figure 1). The tasks and documents produced in the first design phases are presented in Appendix 1.

## DESIGN AS DECISION MAKING

As seen, the plant lifecycle includes many separate steps with decisions. In fact design is a form of decision making. All the steps in design cycle follow general problem solving steps (Figure 2).

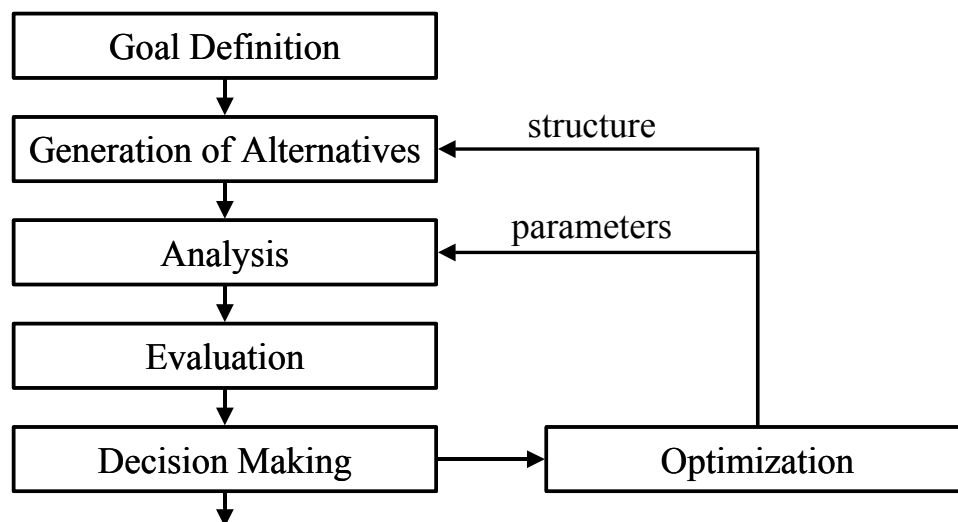


FIGURE 2: The design cycle

### Goals

The project goals need to be aligned with the targets of the firm by analyzing the strategic goals of the company. The analysis of company operating environment is utilized to sharpen design constraints, since it includes an analysis of future trends and stakeholder requirements. This will ensure that the design serves the targets in the long run. This step is important also, since studies show that top managers (CEOs) don't spend much time on the R&D and design related aspects but mainly focus their attention on marketing and production (Roberts, 1977). See Figure 1.

### Generation and Analysis of Process Alternatives

Alternative process modifications are generated by using process synthesis methods, engineering experience and creativity. Analysis of the process alternatives is done with process calculation methods and simulation tools, such as flowsheeting for the influence area selected. The scope definition is important in the evaluation of process alternatives. The different scopes can be equipment, subprocess, process, plant, site, company or community. A new process has usually interaction with the other processes in the site due to the integration benefits. The effects are often related to the utilization



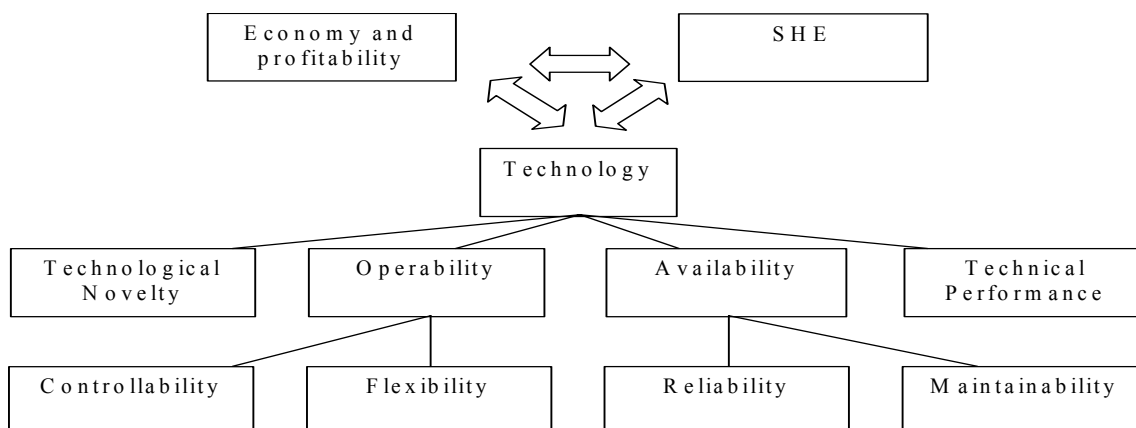
of raw materials, products, side products or utilities. There may also be negative effects due to safety or changes in utility balance. The analysis scope defined should be wide enough to allow consideration of these effects.

### Evaluation, Criteria and Indicators

A process alternative is evaluated by calculating the selected performance indicators for the selected criteria. It is defined, which aspects are included in the evaluation, for example if process safety is concerned and by which indicator it is measured.

Performance criteria are the way to evaluate the process performance. The general process performance criteria can be divided into three categories, which together with their subcriteria cover the criteria needed in industrial decision making (Tuomaala et al. 2001): 1) economy, 2) safety, health, environment (SHE), 3) technological performance (technological novelty, operability, availability and technical performance; a) Operability is further divided to controllability and flexibility. b) Availability is divided to reliability and maintainability (Figure 3).

The three groups have obviously strong interactions. The idea is that one group includes purely economic aspects, the other classical sustainability aspects (i.e. SHE) and the third technical aspects (described in non-economic terms).



**FIGURE 3: The three main groups of evaluation criteria**

The criteria are measured by indicators. For instance the indicators for profitability can be e.g. internal rate of return (IRR) or cash flow. Different indicators represent a different point of view of the criteria.

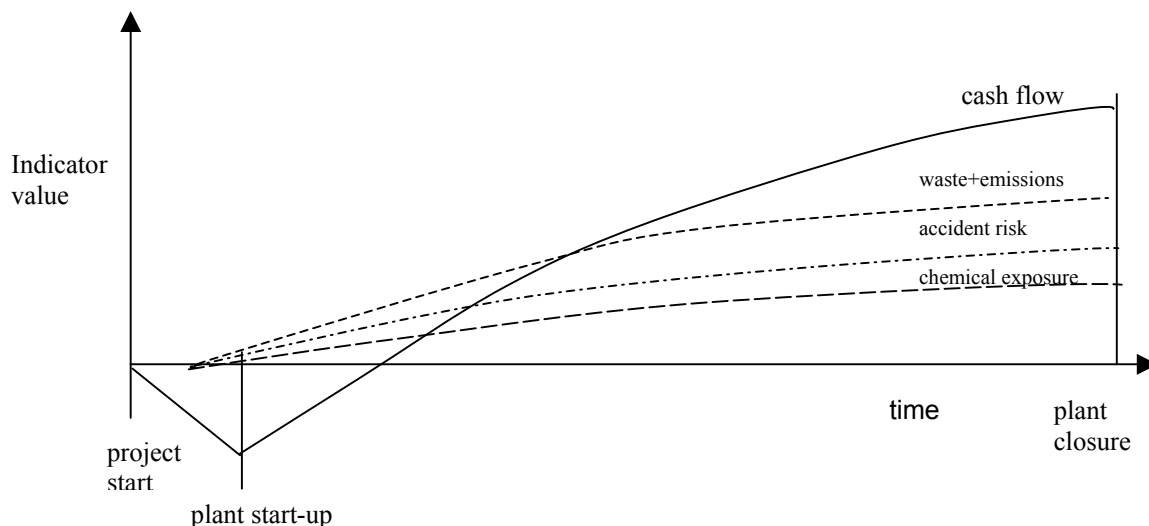
The indicators can be divided into two different categories; 1) indices (or relative indicators) such as safety index and 2) absolute indicators such as accident rate or cash flow per year. Table 2 lists some indicators. Economy can be measured by well known profitability indicators. For SHE index-based approaches (ISI, PRHI, IETH) have been presented for example by Heikkilä et al. (1996), Hassim and Edwards (2005) and Gunasekera and Edwards (2005).

**TABLE 2: Some criteria and their indicators**

Criteria	Index indicator	Absolute indicator
Economy	ROI, IRR	Cash flow, NPV
Safety	ISI	Accident risks, accident rate
Health	PRHI	Chemical exposure, sick leave hours
Environment	IETH	Waste amount, emission rate

### Life-Cycle Perspective

Simple evaluations are often done by assuming a *constant* process performance and a constant operating environment for the whole plant lifetime. This is of course a simplification. For these evaluations typically index based methods are used. More accurate evaluations would use forecasted values for the *lifetime* performance. This means cash flows for economics, waste and emission rates for environmental evaluations, accident rates and consequences for process safety and chemical exposure values represented as cumulative curves (Figure 4). In case of yearly estimates a question rises, whether these should be used as such; i.e. summed together for the lifetime comparison, or should some type of discounting calculation used also for SHE aspects as it is done for cash flows in calculating the net present value (NPV). It can be argued that discounting would also be appropriate for SHE indicators, since immediate risks are most unwanted. For risks taking place later in future there is a possibility to take action in the meantime by installing added-on systems to prevent them, which is not a possible way of preventing immediate risks. Also one may argue that the emissions taking place later are not so harmful as those taking place now for example to employees, because of the shorter predisposing period. Therefore 'discounting' could be done for SHE indicators too, but it is not done, since there is no theory, how much these values should be discounted.



**FIGURE 4: Cumulative cash flow and SHE effect curves for an investment alternative**

## Uncertainty

Uncertainty is present in all aspects of design and forecasting. In fact the main aim of design is to reduce uncertainty. This is gained by increasing knowledge on the systems through the design (Figure 1). In principle three types of uncertainty exists in making process concept evaluations:

- 1) Uncertainty on what is the true performance of the process; i.e. the SHE values and cash flow rates used in evaluations. This uncertainty is possible to be minimized by using advanced studies with modelling and experimentation.
- 2) What are the value settings and preferences of the company and its operating environment; how they are changing with time? This uncertainty can be minimized by better analysis of operating environment and trends, by planning flexible plants and obviously by retrofits
- 3) How is the value of the outputs and other indicators changing with time. What is the economic value of the product. What are the SHE values of the emissions. Are some evaluations changing during time, such as toxicity limits etc. This uncertainty can be minimized by better market studies and forecasting.

In general uncertainty can be managed by:

- 1) Sensitivity analysis, where it is studied, how uncertainty in one variable affects performance indicators.
- 2) Scenarios, where the effect of uncertainty in several variables is analysed at a time.
- 3) Expected value analysis in which probabilities are used and the expected value of performance indicators calculated.
- 4) Real option analysis, in which economic criteria such as NPV include an option premium, which is the flexibility value for the investment in a changing environment. In this way the method tries to take into account the ability of an investment to operate in an uncertain environment (Trigeorgis, 1997).

## Decision Making

In *decision making* the performance of the process is studied by using multiple criteria evaluation. The compromise situations are evaluated. The decision is made, whether the process alternative is to be accepted, improved or rejected.

The growing importance of SHE aspects has increased the number of non-commensurable aspects considered in design. The decisions have to be made more and more in a multicriteria environment and considering uncertainty. A further complicating aspect is the growing degree of process integration, which increases system complexity and makes it difficult to determine the right influence area and number of variables, which are affected by the project. Possible ways of making decisions are the following:

- 1) Expressing all indicators with one measure (single objective function), such as money. This method leads to obvious problems, if non-financial terms, such as safety, cannot be expressed in money terms.
- 2) Another way to change a multiobjective situation to a single one, is to weight different indicators. The weight deriving is however very arbitrary and sometimes leads to unwanted results.
- 3) Pairwise comparison allows comparing alternatives by using a table with selection criteria.
- 4) Analytic hierarchy process allows deriving of weightings by comparing subjectively the relative importance of criteria as pairs.
- 5) Determining Pareto optimality curves gives an understanding of compromise areas. This approach discusses situations with no trade offs.

- 6) Interactive methods allow the decision maker to get a feeling of the aspects affecting on the decision making. These methods however requires a mathematical model of the process or its economics and are not very suitable for comparing discrete cases.
- 7) Visualization is an effective way of presenting different variables in an understandable form for the basis of decisions. There is a wide range of visualization techniques available to aid decision making.

### SUMMARY OF THE PROPOSED ASSESSMENT APPROACH

The method for assessment of process concept in early design phases follows the principle of Figure 2 with some additional features.

Determination of the *goals and priority settings* of the project is done first. This will also affect on all the subsequent assessment steps. It is the task of management to create the company strategy, which will give the priority setting for the projects also. The interpretation of the strategy as project goals is done, when the project is launched and it is expressed in the basis-of-design document.

Identification of the project *key decision points* and variables is done (Virkki-Hatakka et al. 2004). This will help to analyse in which point of the design chain assessments can be done accurately enough. If the main decision on a certain aspect is not yet done, also the evaluation is inaccurate.

Selection of evaluation *criteria* should be done to cover all the groups of criteria represented in Figure 3. The three categories presented together with their subcriteria cover all the criteria needed in industrial decision making.

Selection of the *indicators* for the criteria depends on the design stage where the comparison is made. The comparison criteria change from quite simple indicators in the R&D phase to more accurate ones in the basic engineering phase. For example safety is first measured by only considering safety properties of chemical involved, then by an index method considering the process conditions (temperature, pressure) and heat of reaction. Finally process structure and equipment types are also taken into account (Hurme & Rahman, 2005). The accuracy of the process rankings will also depend on design stage, when it is made: If the main decision on the aspect is not yet done, the result of evaluation is poor. Appendix 1 gives a list of tasks and information produced in the first design steps.

Determining the *scope*, i.e. the area of influence, is important especially in cases with process integration. Typical mistake is to consider a too narrow scope. The scope selection requires knowledge on the process and site. Some effects may be quite widespread such as effect on the utility balance of the site.

Forecasting the *lifecycle* values of the performance indicators is done. The changes in operation environment are considered at least for the main variables.

Consideration of *uncertainty* is based on the analysis of main variables and their level of uncertainty. It is useful to determine what part of uncertainty is predictable (can be reduced) and which is residual (cannot be affected).

In practice *decision making* is typically made by common sense based on facts. Still, to support this kind of decision-making, it is useful to use decision aids. The methods include decision tables etc. but it is necessary to understand that each decision method gives only a limited point of view. Therefore it is necessary to use several methods at a time. Preference should be given to interactive methods, which give an opportunity to get a feeling on the sensitivity of the system on the main variables. *Visualization* is a simple and helpful tool in displaying the effects of main design variables and uncertainty on performance criteria.

## CASE STUDY ON METHYL METHACRYLATE PRODUCTION

A case study on the selection of methyl methacrylate process routes is given to demonstrate the different aspects of decision making.

Methyl methacrylate can be produced in several ways. The most popular is the traditional acetone cyanohydrin route (ACH). Recent development of the technology has made several other routes available: ethylene based route with methylpropionaldehyde intermediate (C2/PA), ethylene based route with methyl propionate intermediate (C2/MP), propylene based route (C3), isobutylene ammoxidation route (iC4), tertiary butyl alcohol route (TBA). The characteristic features of the six process routes to MMA are summarized by Lawrence (1996).

The routes were evaluated based on economic and SHE criteria (Table 3). Such criteria were selected, which are possible to calculate in the early phases of design, especially in the conceptual design phase. They are cost, inherent occupational health, inherent safety and impact to environment. The selected indicators were measured by; manufacturing cost (Lawrence, 1996), Process Route Healthiness Index (PRHI) by (Hassim and Edwards, 2005), Inherent Safety Index (ISI) by Heikkilä et al. (1996) and Inherent Environmental Toxicity Hazard (IETH) by Gunasekara and Edwards (2005). One should note that these represent only a certain point of view of the criteria. For example inherent safety don't include added-on safety systems, which are essential but cannot be evaluated during preliminary design phases.

Combined evaluation of economical and SHE point of views is a typical multicriteria evaluation, since the criteria cannot be combined directly. It would be possible to weight these criteria based on company goals. For this purposes weighted scoring methods, pair wise comparison method or Analytic Hierarchy Process (AHP) can be used. An alternative approach is to use heuristic analysis with visualization of variables.

By using a criteria weighting method, it is found that TBA is the best and ACH the worst process with nearly all values of weightings. If the weights are changed, there are some variations in the process rankings. If SHE criteria are weighted only 5% each, C3 process comes equally good as TBA.

As seen from Table 3 the ACH process is the worst alternative by nearly all of the indicators. It is interesting to notice that ACH process is the most common MMA manufacturing method. Nearly 80% of world capacity is using ACH process, even about 55 % of the new capacity is using other methods (Anon, 2004). There are several reasons to this: 1) Upstream integration; i.e. the raw material availability affects the process selection a great deal. 2) Downstream integration; i.e. the manufacturing cost is less, if the waste streams can be properly integrated: The given ACH process cost value includes costs for the auxiliary units needed for the process. In some cases these may be existing and common with other processing units, which lowers the cost. 3) The evaluation by using these indicators does not reflect all decision aspects: For instance the added-on safety aspects, such as control systems cannot be evaluated in the conceptual design phase. Also; the IETH index represents only environmental toxicity hazards due to catastrophic failures in the plant, not normal emissions.

**TABLE 3: Economic and HSE evaluation of the methyl methacrylate process alternatives (best values underlined)**

Process route	Relative manufacturing cost / t	Health PRHI	Safety ISI	Environment IETH
ACH	1234	2578	132.3	68.0
C2/PA	1042	1073	89.3	24.7
C2/MP	903	22	89.3	16.3
C3	<u>780</u>	2659	66.7	21.4
i-C4	897	13	<u>61.33</u>	<u>10.1</u>
TBA	839	<u>5</u>	<u>61.33</u>	15.7
	Lawrence (1996; modified)	Hassim & Edwards (2005)	Rahman et al. (2005)	Gunasekera et al. (2005)

## CONCLUSIONS

Because of the sustainability requirement set to the chemical processes, their evaluation in the conceptual design phase is coming more demanding. The paper presents an approach for comparing process concepts in a multicriteria environment during the early phases of design. In these phases typically many index-based methods are used for SHE evaluations. The right selection of indicators is important, since they may have a narrow point of view. It should be noticed also, that the integration aspects in up- and down-stream side of the process affect much on the feasibility as well as the raw material availability on the site, which is much of a strategic issue. These aspects are sometime underestimated in evaluations. The selection of the scope of evaluation is important, since the extent of integration and possible common auxiliary units determine much of the economics of the process nowadays.

## REFERENCES

- Anon. 2004. "Present production status and market projection of methyl methacrylate". *CCR* 15 (26): 22-24.
- Gunasekera M.Y. and D.W. Edwards. 2005. "Chemical process route selection based upon the potential toxic impact on the aquatic, terrestrial and atmospheric environments". *Journal of Loss Prevention in the Process Industries* (in press)
- Hassim M.H. and D.W. Edwards. 2005. "Development of a Methodology for Assessing Inherent Occupational Health Hazards". *Chemical Engineering and Design* (submitted).
- Heikkilä, A-M., M. Hurme and M. Järveläinen. 1996. "Safety Considerations in Process Synthesis". *Computers and Chemical Engineering* 20: S115-S120.
- Hurme M. and M. Rahman. 2005. "Implementing inherent safety throughout process lifecycle". *Journal of Loss Prevention in the Process Industries* 18: 238-244.
- Hurme, M and M. Tuomaala. 2003. "Tools and methods for comprehensive process integration". In *Proceedings of European Congress of Chemical Engineering (ECCE 4)*.
- Lawrence, D. 1996. *Quantifying Inherent Safety of Chemical Process Routes*. Ph.D. Thesis, Loughborough University of Technology.
- Trigeorgis L. 1997. *Real Options: Managerial Flexibility and Strategy in Resource Allocation*, 2nd Ed., MIT Press, Cambridge.
- Roberts, E.B. 1977. "Generating Effective Corporate Innovation". *Technology Review* Oct/Nov: 2.
- Tuomaala, M, Hurme, M., Hippinen, I., Ahtila, P., Turunen, I. 2001. "Analysis of process performance in process integration". In *Proceedings of 6th World Congress of Chemical Engineering*, Melbourne.
- Virkki-Hatakka, T., Cziner, K., Turunen, I., Hurme, M. 2004. "Decision analysis as a project management tool for product and process design". In *Proceedings Foundations of Computer-Aided Process Design*, AIChE, Princeton, p.405-407.

### APPENDIX 1: Tasks of conceptual design phases, information produced and cost, environmental and safety indicators available in the first design phases

LC phase	Tasks	Information produced	pro- Cost	Environ-ment	Safety
Idea phase	First check of feasibility on economics, and SHE	First evaluation of feasibility Basic data on chemicals	Material margin	Chemical properties	Chemical properties
Process R&D	Examination of raw materials and reaction chemistry Creation of process alternatives Examination competing processes, patent and license situation Market analysis Examination of legal aspects Laboratory & reaction calor. tests Preselection of unit operations Bench and pilot scale tests Making of prefeasibility study	Chemicals used and their characteristics Chemical reactions Chemical interactions Reaction thermodynamics Physical properties First process concept First flowsheet Pre market study Prefeasibility study	Rough investment cost $\pm$ 50 % Operating cost, Profitability	Inherent environ. indices, Environ. properties of chemicals and side products	Inherent safety indices, Chemical and reaction hazards
Process predesign	Process concept selection from alternatives Selection of unit operations Flowsheet simulation Preliminary equipment sizing Logistics and material flows anal. Rough ISBL layout Estimations of emissions Making of feasibility study	Process concept Flowsheet Material balance Energy balance Operating conditions Layout sketch Feasibility study (profit, SHE) Market study	Preliminary investment cost $\pm$ 30 % Operating cost Profitability	Emission rates and their effects, Prelim. environm analysis	Inherent safety indices, Dow F&E index





# DYNAMIC MATERIAL FLOW ANALYSIS IN THE LIFE CYCLE ASSESSMENT TOOL CHAIN

Andreas Möller

University of Lüneburg, Germany

Dynamic Material Flow Analysis (MFA) and Life-Cycle Assessment (LCA) are often discussed as different approaches in the field of corporate sustainability. Whereas dynamic MFA is focused on the dynamic behavior of flows and especially stocks in time, LCA is based on the principle of cause and effect and results in static models. LCA and LCA-type approaches like life-cycle costing have to determine the material and energy flows, the corresponding impacts and costs relating to the positive outcomes of a decision.

Both approaches provide their own, valuable results. In this article, the different results are interpreted as indicators of industrial metabolisms in distinct perspectives. To provide data in more than one perspective, hybrid analyses are required, and different methods have to be linked together. One architectural design pattern for such a framework is the tool chain. This article demonstrates how to implement such a modeling tool chain in the domain of industrial ecology.

Hybrid analysis comprises also the integration of the results. To bring together results in different perspectives this article proposes to apply the balanced scorecard concept to industrial ecology or the analysis of industrial metabolisms in different perspectives.

## INTRODUCTION

Udo de Haes et al. (2004) have discussed three strategies to overcome the limitations of life-cycle assessment. One strategy is to broaden its field of applicability (see Udo de Haes et al., 2004: 20). Indeed, such extensions cannot overcome limitations of the concept. The conceptual limitations result from a special interpretation of the principle of cause and effect. The cost accounting expert Riebel discusses three different interpretations: the causal interpretation, the final interpretation (or means-end relationship), and the identity principle (Riebel, 1990: 49).

Life-cycle assessment follows the most common interpretation in cost accounting and analyses means-end relationships. Consequently, the first modeling step to determine life-cycle inventories starts with a functional unit or a reference flow. The challenge of this step is to determine all material and energy flows associated with the reference flow. Here another interpretation of the principle of cause and effect comes into play: the causal interpretation (for details see Riebel, 1990: 70). If networks of material and energy flows without any references to products or services are modeled using material flow analysis methods, such a model follows the causal interpretation. The challenge for life-cycle assessment is to bring together these two interpretations. To do so, life-cycle assessment looks at networks of material and energy flows, stocks and transformation processes in a specific perspective: stocks are not allowed, processes are specified in a linear manner by production coefficients, and joint productions are divided into single product processes using allocation rules. The function of life-cycle inventory methods is to determine all process levels so that all input and output flows can be calculated applying the production coefficients. Indeed, such a perspective has several weaknesses. Particularly, life-cycle assessment decomposes complex, joint networks of material and energy flows and stocks into several disjoint models, represented by flow graphs, one for each product.

Another strategy is to provide a toolbox with different modeling tools. Such an approach allows incorporating different modeling methods. The modeling expert selects that tool most suitable for his problem. For example, if dynamic material and energy

flow networks with recycling loops and different products within a closed-cycle-economy should be analyzed a dynamic material flow analysis tool is appropriate. It could be interesting to combine the results with life-cycle assessments of all involved products. But such a combination is not intended in the toolbox strategy.

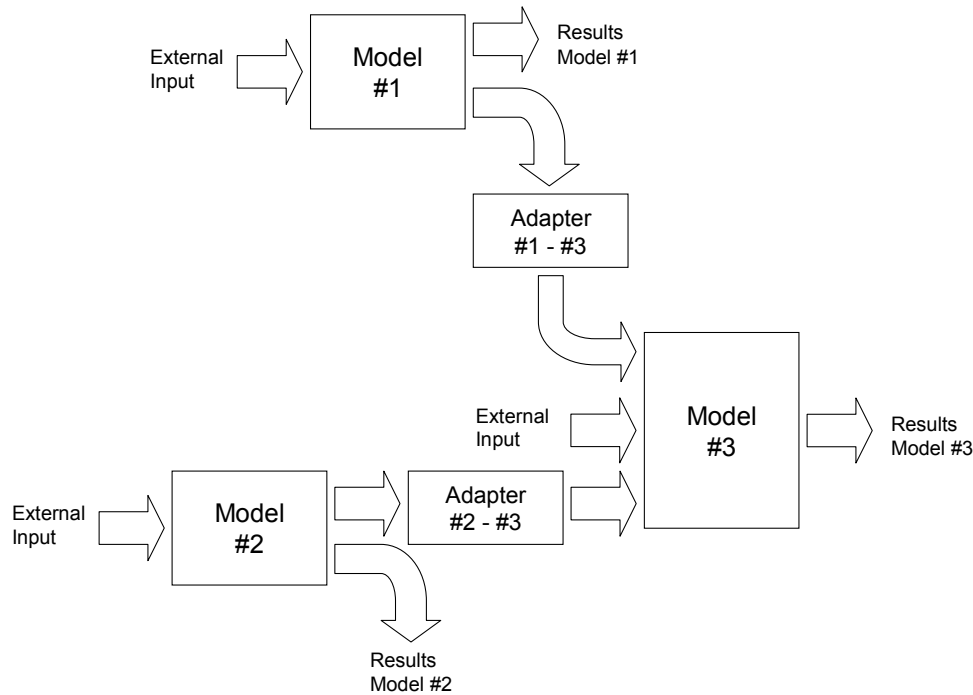
Consequently, Udo de Haes et al. call the third strategy hybrid analysis. They discuss mainly the combination of traditional process-oriented life-cycle assessment and input-output life-cycle assessment. This paper proposes a tool chain that allows the combination of dynamic material flow analysis, static material flow analysis and life-cycle assessment. In this tool chain, life-cycle assessment stands for a set of tools which identify means-end relationships within the networks and calculate respective results, mainly life-cycle inventories and cost.

### **HYBRID MODELS IN INDUSTRIAL ECOLOGY**

To use hybrid analysis in the field of industrial ecology, it is necessary to consider the architecture of the model, resulting from the composition of different models, particularly with regard to the design of appropriate software support. Each of the models has to accomplish two different functions. The first is to produce its own results; the other is to serve as a data provider for other models in the framework. For example, process simulation tools provide information about waiting times, dwell times, bottlenecks and so on. But process simulation can also serve as a data provider for material flow analysis and life-cycle assessment (see Wohlgemuth, 2005); process simulation is an important link to product design (Möller & Rolf, 2001).

Ideally, the output of one model can serve directly as data input of another. Unfortunately, mostly some kind of mapping between the involved models is required. Following the adapter design pattern in software engineering, conceptual adapters are normally required between the different models. One example is the combination of period-oriented material flow analysis and life-cycle assessment. Material flow analysis results can serve as a data input for life-cycle assessment, but not directly. Some adaptations are required, for example the application of allocation rules in case of joint productions. It is the principal purpose of an adapter to perform these adaptations.

Several network architectures are possible (see figure 1). The term tool chain describes one of them. The tool chain stands for a chain of different models or instruments, one model serves as a data provider for the subsequent. A generalization of the tool chain is the central database. One of the methods has to provide a central database. On the one side, chains of tools are used to insert data into the database; on the other side, tools or tool chains evaluate the database under different perspectives.



**FIGURE 1: Modeling framework for hybrid analysis**

However, the resulting network of models has to meet several requirements: What is the relationship between the results of the different analyses? How can overall consistency in the results be ensured? Common perspectives and metaphors help to guarantee overall consistency in such a system. One of such metaphors in the field of industrial ecology is industrial metabolism.

### ANALYSES OF INDUSTRIAL METABOLISMS

As mentioned above, it is necessary to distinguish networks of material and energy flows and stocks in general, and the specific perspective of life-cycle assessment. The term industrial metabolism can be used for these generalized networks (see Fischer-Kowalski, 1998: 62). It bases on the analysis of metabolisms in biology and ecology. Terms like industrial metabolism or socio-economic metabolism stand for approaches to apply the topics, ideas and approaches to socio-economic systems: “It makes sense, therefore, to look at human communities and societies as organizations serving human survival. Societies will, in effect, sustain a metabolism that at least equals the total metabolism of their members” (Fischer-Kowalski, 1998: 63). The metabolism as a metaphor introduces analogous categories of sub-systems like production, consumption, reduction and so on. It provides the prerequisites to model sustainable and self-referencing material and energy flow systems. In fact, the metabolism perspective is already basis of modern production theory (see Dyckhoff, 1994, Schmidt, 2005).

The purpose of life-cycle assessment, material flow analysis and other instruments is to provide data on industrial metabolisms. In the toolbox strategy there are no links provided between these instruments, and because of possible inconsistencies in the models it is a big challenge to transfer data between the models and to integrate the results. Here, the metabolism approach can serve as an overall concept and integration platform. The representation of material and energy flows and stocks in the considered

system can serve as a data source for different evaluation tools. This database has an analogous function to business accounting systems in companies.

### **Material Flow Networks as a Database**

A well-established accounting method in the private sector is double-entry bookkeeping. The purpose of double-entry bookkeeping is to represent the financial flows and stocks of an organization. This uniform method makes it possible to carry out different evaluations. It provides information on what financial flows have occurred in a period under review (fiscal year) and how the opening inventory has changed after this period.

The material flow network approach is an analogous accounting system, but its purpose is to represent industrial metabolisms. Here, material and energy flows instead of financial flows are considered. The objective of material flow networks is to trace material and energy flows and stocks within a company or between different companies within a value chain (Schmidt et al., 1997).

Based on the concept of Petri Nets (Reisig, 1985) material flow networks consist of three different types of model elements: transitions, places, and arrows. The nodes in the network may be either transitions, visualized as squares, or places, represented by circles. Between these nodes there are arrows as linking elements. Transitions are those objects in a material flow network, where material and energy transformation processes occur. Each transition can, on the one hand, be connected to places from which it is supplied with materials and/or energy (input), and on the other hand be connected to places to which it delivers materials and/or energy (output). Places represent storages in which time transformations take place. As a result a period-oriented material and energy flow model is obtained.

Such a model or database of material and energy flows and stocks can be evaluated directly by means of input/output balances. A table lists inputs and outputs of all material and energy flows of the system within the accounting period. It is also possible to analyze only parts of a system, for example single production plants within a value chain. Therefore, input/output balances provide important indicators which characterize the metabolic throughput of systems, relating to a specific time period.

Time series of input/output balances can provide information about the development of the material and energy flows of a metabolism, but this approach does not emphasize the dynamic behavior of material and energy flows. Thus, material flow networks can be characterized as a static material flow analysis method. Nevertheless, the concept of places provides an ideal interface to dynamic material flow analysis.

### **Life-Cycle Assessment as a Client Method of Material Flow Models**

As mentioned above, LCA-like instruments require input data in a specific format. If material flow model should serve as a data provider for life-cycle assessment, an adapter has to transform the data into this specific format. The adapter has to perform the following tasks:

1. Identification of all functional units or reference flows, in other words products and services, in the material and energy flow model.
2. Input and output flows of the processes are interpreted as linear production coefficients. In case of cost accounting the cost drivers are included too.
3. The reference flows of the processes, mainly the products, must be identified. In case of joint productions, identifiable by the number of reference flows or products, allocation rules must be applied, to obtain single product processes.

4. On the basis of the network, a flow chart has to be constructed. This graph contains only single product processes.

The flow graph is the data input of common matrix methods. These methods calculate the process levels of all involved processes; thereafter, the production coefficients and cost drivers are used to calculate the product related material and energy flows and cost.

The application of the adapter requires some preparations in the material flow model. It must be possible to identify the reference flows, joint productions and so on. In this regard the production theory of Dyckhoff is of special importance (see Dyckhoff, 1994, with regard to life-cycle assessment Schmidt, 2005). In particular, the categorization of all material and energy flows into 'goods', so-called 'bads' and 'neutrals' links two levels, the object level of material and energy flows, and the level of economic revenues and economic and/or ecological expenditures. Moreover, this concept also links two interpretations of the cause-and-effect relationship: the causal interpretation on the level of material and energy flows and stocks, and the means-end relationship on the level of revenues and expenditures.

### **Dynamic Material Flow Analysis as a Data Provider**

Static material flow analysis is not the only approach to represent networks of material and energy flows and stocks. Another basic approach is dynamic material flow analysis (Müller et al., 2004). The term 'dynamic' indicates that these models are focused on the temporal dimension of material and energy flows and stocks.

Even though dynamic material flow analysis provides new insights, it can also serve as an important data provider for static material flow analysis. It is often difficult to specify the input data of the static material and energy flow models, for example in case of chemical processes. Sometimes it is easier to describe the dynamic behavior of such a material and energy flow system in terms of growth rates, decay, half-life periods and concentrations, particularly regarding semi-closed loops and delayed feedbacks.

Dynamic material flow analysis is a specific domain of dynamic modeling. If the number of state changes in the model is finite, these models are called discrete event simulation models. Discrete event simulation models are used to analyze behavior or strategies for warehouses, production chains or call centers and so on (Page, 1991).

In some systems the states change continuously. To deal with these dynamic systems continuous simulation models are more appropriate. A well-known modeling technique in the field of continuous simulation is System Dynamics (Forrester, 1961, Hannon & Ruth, 2001). System Dynamics models contain a number of stocks, shown in diagrams as rectangles, and flows, displayed as double-lined arrows. Any flow directed to the stock increases its level, and the flow going out of the stock decreases its level. The amount of flow in and out is regulated by rates, visualized as "water valves". So-called connectors, visualized as circles, are used as helper elements to specify user-defined functions and parameters. They are linked to other nodes in the diagram and serve as "information flows". The information flows control the water valves, and often the stocks in the model are the origin of the information flows. By this means, the modeling approach makes it easy to represent and simulate feedback systems.

An important drawback of System Dynamics in the application domain of dynamic material flow analysis is that it is practically almost impossible to represent material and energy transformations. As well, it is a challenge to deal with a multitude of material and energy flows in System Dynamics models. Consequently, System Dynamics is indeed discussed in literature, but scarcely applied in practice.

In principle, two types of enhancements are possible. The first option is to represent material and energy transformations in System Dynamics models. Whereas in tra-

ditional System Dynamics models the water valves control exactly one flow, the transition specifications in Material Flow Network models allow several input and output flows to be incorporated, and mappings between inputs and outputs can be specified. This approach can be applied in System Dynamics models, too. Consequently, such a modeling approach has to deal with more internal flows, new input/output flows, and more stocks. Nevertheless, the underlying simulation methods, in particular the integration methods, are not significantly affected by this extension. This enhancement of System Dynamics could be called material flow dynamics (Möller, 2004).

Adapters to static material and energy flow models can be realized straight forward. Two approaches are feasible. The first is to calculate the period-oriented mean value of all material and energy flows within the dynamic model; the stocks at the beginning and the end of the periods can be transferred directly. In the second approach possible steady states should form the data input of the static material and energy flow model. In this case possible warm-up periods should be ignored.

A second enhancement is to not to extend the System Dynamics concept but to implement a more ambitious adapter. In that case, it is not the purpose of the System Dynamics model to represent and to simulate material and energy flows and stocks directly. Rather, the model represents structures that have a significant influence on the material and energy flows and stocks: human behavior, knowledge, mega trends in the society and so on. In terms of the impact of such structures on material and energy flows, these models provide core indicators of the underlying material and energy flow systems. In the material flow networks these indicators are used as transition parameters; they determine process levels, operation conditions and so on. To some extent, the transition specifications in the material flow network are part of the adapter.

The two possible enhancements are not equivalent. They cover different application domains. The first approach aims at data collection problems, in particular in case of chemical processes. The second approach, in contrast, combines two different perspectives. It is not necessary that the System Dynamics models deal with material and energy flows and stocks. Rather, they are used to represent human behavior, and the material flow models are needed to understand the impacts of human behavior on industrial metabolisms. Here, the adapter links two really different models.

In particular, the second solution to integrate dynamic modeling and static material flow analysis and subsequent life-cycle assessment makes clear that the relationship between the different models comprises not only data transfer. The question is how to bring together the different results. One interesting approach in strategic management of organizations that deals with different perspectives and worldviews is the so-called balanced scorecard.

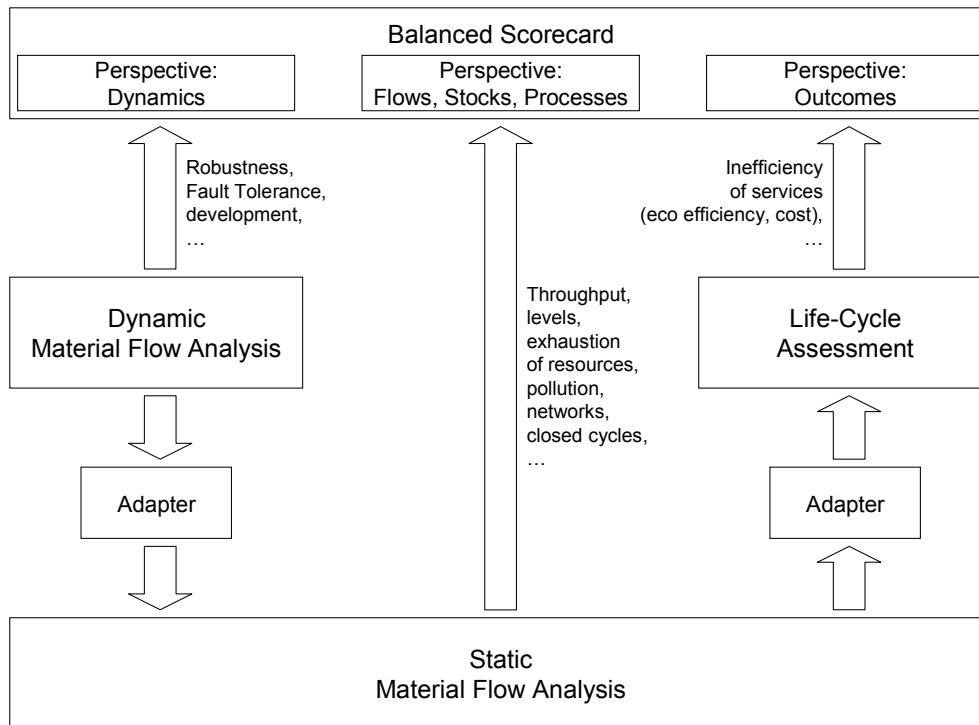
## **BALANCED SCORECARDS IN INDUSTRIAL ECOLOGY**

The balanced scorecard is an approach to bring together different fields of corporate activity. The presumption of the balanced scorecard is, that strategic management of organization only in one perspective, the financial perspective, is not reasonable. Additional perspectives are required to draw the whole picture: regarding motivated and skilled employees, high-quality processes, products and services, satisfied and loyal customers (Kaplan & Norton, 1996: 7). So the balanced scorecard consists of several different performance indicators in usually four perspectives: the financial perspective, which measures the ultimate results, the customer perspective, which focuses on customer needs and satisfaction, the internal perspective, which looks at the performance of internal processes, and finally the learning & growth perspective, which directs attention the organization's people and infrastructure (Kaplan & Norton 1996).

Normally, the balanced scorecard is discussed in industrial ecology as a tool that helps to integrate industrial ecology issues into company's strategy formulation and implementation. A few key performance indicators, mainly eco-efficiency indicators, should represent the environmental performance of the company, either in a conventional balanced scorecard with four perspectives or in an enhanced sustainability balanced scorecard with an additional non-market perspective (see Möller & Schaltegger, 2005).

But the underlying idea of the concept is also interesting. It helps to integrate several different perspectives, and that's exactly the situation in hybrid analysis of industrial metabolisms. It is not meaningful to characterize industrial metabolisms by means of a few traditional indicators like overall production or growth rates. In the words of Kenneth Boulding, "the essential measure of the success of the economy is not production and consumption at all, but the nature, extent, quality, and complexity of the total capital stock, including in this the state of the human bodies and minds" (Boulding 1966: 9, cited in Fischer-Kowalski, 1998: 70). Consequently, as in the classical application context of the balanced scorecard, industrial metabolisms should be analyzed in different perspectives using different modeling approaches. These models should provide data about the quality of industrial metabolisms, robustness, complexity, fault tolerance and so on; they should help to identify options for action. As in the conventional balanced scorecard, metabolism core indicators (see Fischer-Kowalski & Hüttler, 1999: 118) could characterize metabolic profiles and developments.

Is it possible to distinguish different perspectives? In fact, the different modeling approaches refer to corresponding perspectives. The background of life-cycle assessment, for example, is inefficiency of services and products, the background of dynamic and static material flow analysis are metabolic throughput and development. Additional hints can be derived from typical problem classes of the society's metabolism. Fischer-Kowalski and Hüttler mention exhaustion of resources, pollution, entropy, inefficiency of services, closing open cycles, and finally scale and growth of metabolic throughput (Fischer-Kowalski & Hüttler, 1999: 119-120). They note that these problem areas are associated with a wide spectrum of views and scientific paradigms. So at least four perspectives can be identified: the perspective of single products and services, the perspective of the state and development of metabolisms, including flows, stocks, processes, levels, complexity and diversity, fault tolerance, cycles and feed-back loops, the entropy perspective and the stakeholder perspective including mega trends in the society like the information society, corporate management, organizational learning and so on. Taken together, a balanced-scorecard-like integration instrument would show the current state and possible developments of industrial metabolisms.



**FIGURE 2: Tool Chain in Industrial Ecology**

The balanced scorecard not only helps to characterize complex systems in different perspectives. Newer publications of Kaplan & Norton point out the relationship between the perspectives. They assume that it is possible to identify important dependencies. Therefore, concepts are required to identify the dependencies. Such a concept is the so-called strategy map, a visual representation of the cause-and-effect relationships among different perspectives (Kaplan & Norton, 2004). In fact, these relationships can also be identified in balanced-scorecard-like management instruments in industrial ecology. For example, developments of metabolic throughput like closing open cycle have an effect on the efficiency of products and services and entropy; trends towards an information society influence scale and development of the metabolisms on the whole.

Kaplan & Norton emphasize the central role of strategy maps in the development of balanced scorecards. Strategy maps are not only visualization tools that help to overlook complex systems. They are as well an important starting point for the modeling process: What are the instruments, we need in the hybrid analysis? Which core metabolic indicators should the instruments provide? In a way, the balanced scorecard becomes the starting point as well as the end point of the whole modeling process.

## CONCLUSIONS

Industrial metabolisms can be analyzed in different perspectives. Corresponding methods are for example dynamic material flow analysis, static material flow analysis and life-cycle assessment. Comprehensive analyses of industrial metabolisms require the integration of different perspectives and methods. This article should demonstrate possible implementations of a tool chain in which the different methods are linked through appropriate adapters.

Analogous to corporate management accounting, one or two of the instruments serve as a central database; they are the core instruments of an environmental accounting system. In a framework of modeling tools that help to characterize industrial me-



tabolisms, material flow analysis methods like material flow networks provide a basis for such a central database. As outlined above, life-cycle assessment, life-cycle costing and eco-efficiency analysis serve as evaluation methods, connected to the database by an appropriate adapter. On the other side, in particular simulation models on the basis of dynamic material flow analysis methods, exemplify data input methods of such a central database.

Of course, such a tool chain with basically three instruments is only a starting point. A perspective regarding entropy is not included. Nevertheless, all the instruments provide valuable results. The question arise how to bring together the different results. One interesting instrument in the domain of strategic management is the balanced scorecard. In particular, the underlying idea of the balanced scorecard provides a conceptual basis for integrating the results of hybrid analyses in terms of core metabolic indicators in different perspectives.

## REFERENCES

- Boulding K. 1966. "The economics of the coming spaceship earth." In K. Boulding et al. (Eds.), *Environmental quality in a growing economy*. Baltimore, MD.
- Dyckhoff H. 1994. *Betriebliche Produktion (Corporate Production)*. 2nd ed., Berlin, Heidelberg, New York.
- Fischer-Kowalski M. 1998. "Society's Metabolism – The Intellectual History of Material Flow Analysis, Part I, 1860 – 1970." *Journal of Industrial Ecology* Vol. 2, No. 1: 61-78.
- Fischer-Kowalski M., W. Hüttler. 1999. "Society's Metabolism – The Intellectual History of Material Flow Analysis, Part II, 1970 – 1998." *Journal of Industrial Ecology* Vol. 2, No. 4: 107-136.
- Forrester J. W. 1961. *Industrial Dynamics*. Cambridge, MA.
- Hannon B., M. Ruth. 2001. *Dynamic Modeling*. 2nd ed., Berlin, Heidelberg, New York.
- Kaplan R. S., D. P. Norton. *The Strategy-Focused Organization: How Balanced Scorecard Companies Thrive in the New Business Environment*. Boston, MA.
- Kaplan R. S., D. P. Norton. 2004. *Strategy Maps – Converting Intangible Assets into Tangible Outcomes*. Boston, MA.
- Möller A., A. Rolf, A. 2001. "Eco Product Lifecycle Management." *Proceedings of the EcoDesign 2001: Second International Symposium on Environmentally Conscious Design and Inverse Manufacturing*. Tokyo, Japan.
- Möller A., S. Schaltegger. 2005. "The Sustainability Balanced Scorecard as a Framework for Eco-efficiency Analysis." *Journal of Industrial Ecology* Vol. 9, No. 4 (in press).
- Müller D.B., H.-P. Bader, P. Baccini. 2004. "Long-term Coordination of Timber production and Consumption Using a Dynamic Material and Energy Flow Analysis." *Journal of Industrial Ecology* Vol. 8, No. 3: 65-87
- Riebel P. 1990. *Einzelkosten- und Deckungsbeitragsrechnung (Direct Costing)*. 6. ed., Wiesbaden, Germany.
- Schmidt M. 2005. "A production-theory-based framework for analysing recycling systems in the e-waste sector." *Environmental Impact Assessment Review* Vol. 25, No. 5: 505-524.
- Schmidt M., A. Möller, J. Hedemann, P. Müller-Beilschmidt. 1997. "Environmental Material Flow Analysis by Network Approach." In W. Geiger et al. (Eds.), *Umweltinformatik '97*. Marburg, Germany.
- Udo de Haes H. A., R. Hejungs, S. Suh, G. Huppes. 2000. "Three Strategies to Overcome the Limitations of Life-Cycle Assessment." *Journal of Industrial Ecology* Vol. 8, No. 3: 19-32.
- Wohlgemuth V. 2005. *Komponentenbasierte Unterstützung von Methoden der Modellbildung und Simulation im Einsatzkontext des betrieblichen Umweltschutzes (Component-based software support of modeling and simulation methods in the context of corporate environmental protection)*. Aachen, Germany.



## FROM A FEW SUNS TO TEN THOUSAND OF SUNS

Yingtian Chen <sup>a</sup>, Yanan Wang <sup>b</sup>

<sup>a</sup> Department of Astronomy and Applied Physics  
University of Science and Technology of China

<sup>b</sup> Institute of Electrical Engineering, Chinese Academy of Sciences

**Using the limited sources of solar materials for the maximum output of energy is one of the great challenges in industrial production. This article gives a brief report for the application of a new theory of focusing and sun tracking in harnessing sun power from concentration of a few suns to high concentration of ten thousand of suns. It is hopeful that the new theory of optics can suggest some solutions for the solar energy applications in various forms.**

### THE CONCEPT

The new theory developed by the author in the past years has discarded the tradition in optics to discuss the optical components with a fixed geometry; instead, the new geometry of the optical reflector or lens are defined instantly using tracking or predefined by digital means. The theory is specially developed to tackle one of the fundamental limits in optics, Aberration.

Aberration can be understood as a kind of general distortion of image. This usually greatly affects the quality of the imaging and focusing ability of the equipment. There are various forms of aberrations which are the adhesion characters of certain type of fixed geometry of optical lenses or mirrors. The new theory is discussing how to use variable geometry to achieve the minimum aberration. The aim of the study is to find the most cost effective method realizing the geometry correction. So far the astonishing finding of the theory is to use line movement to replace tip-tilting of the mirrors. This has created the great opportunity to produce a low cost reflective compound mirror. This kind of compound mirror consists of N row and M column facets and traditionally uses  $2 \times N \times M$  controls to realize the correction for a near zero aberration; the theory makes the number of control to be  $N+M$ . The theory may find many applications in a number of fields, harnessing solar energy is one of them.

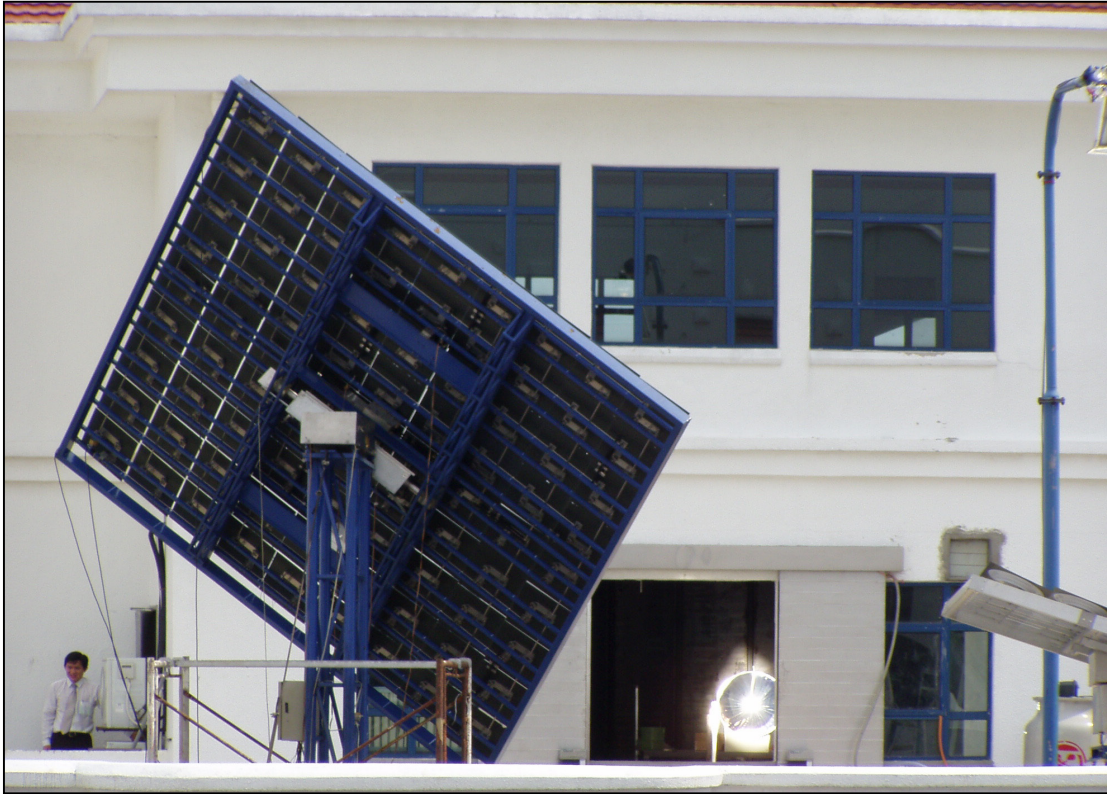
### METHODOLOGY DIFFERENCE IN HARNESSING SOLAR ENERGY

#### 1) Instead of two-stage collection, one stage concentration is possible.

The basic mathematics and structure of solar collectors have remained unchanged for many decades. In traditional ultra-concentration application, e.g., solar furnace, two stages of collection with heliostat of flat reflectors and parabolic collector of the same cross-section are required to achieve the concentration of 10,000. The huge cost of constructing such solar furnace has hindered the popular use of ultra high concentration solar collector.

With manoeuvrable facets, novel digital heliostat provides extra concentration, therefore to make traditionally two-stage design into one stage or near one stage design where the secondary collector is rather small comparing to the dimension of the heliostat. These secondary we used to name them as optical catcher, optical funnel or small secondary. The new method redirects the design of solar furnace into a much cost-effective way. This has brought high feasibility for the new heliostat to replace the tra-

ditional design in future high temperature solar collector. FIGURE 1 shows a 10 kW solar furnace using the principle of new theory to reach a concentration of 10,000.



**FIGURE 1: The prototype of solar furnace using new theory**

**2) Instead of elevation-azimuth tracking method, elevation-spinning tracking is employed for the primary tracking.**

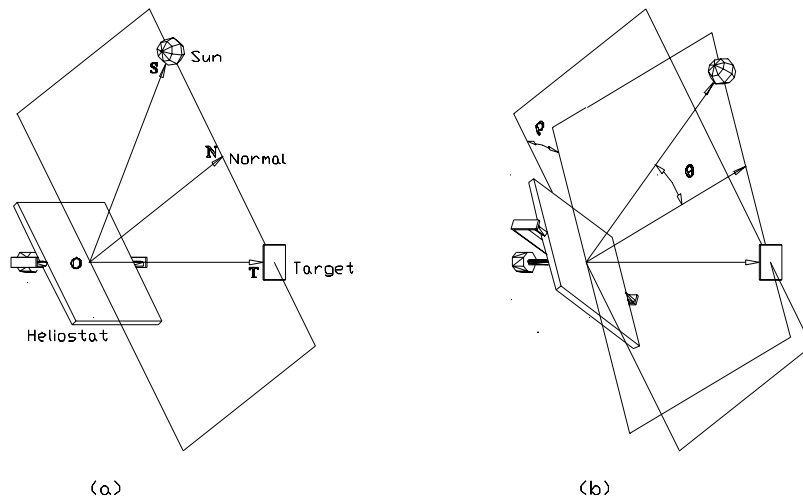
Traditionally, the sun tracking is using elevation-azimuth method that the azimuth axis is towards the zenith

In this structure, the formula of the tracking is much simpler as shown in the following

$$A_A = \text{ArcSin} \left( \frac{\text{Cos} \lambda \text{Sin} \phi + \text{Cos} \alpha \text{Sin} A}{2 \text{Cos} \theta \text{Cos} \theta_A} \right) \quad (1)$$

$$\theta_A = \text{ArcSin} \left( \frac{-\text{Sin} \lambda + \text{Sin} \alpha}{2 \text{Cos} \theta} \right) \quad (2)$$

Readers would sympathize us not to illustrate in details the problems involved with this tracking formula including the corresponding mechanical structures and the optical aberrations it brought to. Our new method uses target-oriented method as shown in the diagram.



**FIGURE 2: Target-oriented sun tracking**

The new elevation-spinning tracking formula is derived as shown in the following.

(3)

$$\theta = \frac{\pi}{4} - \frac{1}{2} \text{ArcSin} \left\{ \begin{array}{l} -\text{Cos} \delta \text{Cos} \omega (\text{Sin} \lambda \text{Cos} \Phi + \text{Cos} \lambda \text{Cos} \phi \text{Sin} \Phi) - \text{Cos} \delta \text{Sin} \omega \text{Cos} \lambda \text{Sin} \phi \\ + \text{Sin} \delta (\text{Cos} \lambda \text{Cos} \phi \text{Cos} \Phi - \text{Sin} \Phi \text{Sin} \lambda) \end{array} \right\}$$

(4)

$$\rho = \text{ArcSin} \left\{ \frac{-\text{Cos} \delta \text{Cos} \omega \text{Sin} \phi \text{Sin} \Phi + \text{Cos} \delta \text{Sin} \omega \text{Cos} \phi + \text{Sin} \delta \text{Sin} \phi \text{Cos} \Phi}{\text{Cos} \beta} \right\}$$

New tracking formula looks much more complicated than the traditional one, with the aid of computers it revolutionized the design of solar collectors not only in the respect of mechanical structure but also in the respect of optical characteristic. Mathematically, the new formula provides a perfect means to match the optical array of row and column to achieve a minimum aberration. The reason is that this is the only mode of tracking that can keep the row of facets in the tangential plane and the column of facets in the sagittal plane.

### 3) Different geometries of the surface of the reflectors

As mentioned before, fixed geometries are used traditionally. Those geometries are usually spherical, parabolic, cylindrical, hyper parabolic, etc., most of them can be expressed by mathematical functions. In new optics, there are two categories of surfaces, one is movable facets arranged in row and column, they usually used for ultra-concentration, e.g., a few thousand suns or above; one is fixed geometry but with continuous change of curvatures, which can be described by high order of polynomial functions, they usually used for high concentration, e.g., a few hundred of suns.

The fixed geometry surface in new Optics is an interesting case, which falls into the Ries's conjecture about ten years ago. In 1990 and 1995, Ries et al. made a proposal that by using a target aligned tracking method, the aberration can then be reduced considerably by using a non-symmetric heliostat with two different radii of curvature. With the tool of new optics, we can digitally plot a special surface that may give a sun con-

centration with minimum aberration. This surface has different profiles of radii along row and column directions. Although the radii of curvature along the column are symmetric but vary at different lines, the radii of curvature at the upper part and down part of the row are different. That means, the surface has the radii curvature almost different at every point. The details of the shape are depending upon the target distance, dimension of the heliostat, facing angle and target angle of the system but independent of the latitude of the heliostat. Mathematically, we have proved that the fixed geometry is capable to obtain a concentration of a few hundred suns in the case that the target axis is located at the positions defined by a patent of Chen and others. This special case of fixed geometry has greatly benefited manufacturer for the cost effectiveness in mass production. The attached photo in Fig.3 has shown a prototype of such a surface.

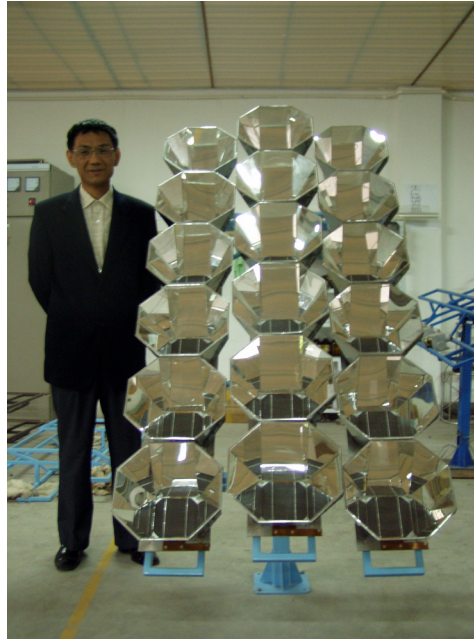


**FIGURE 3: A new surface capable of minimizing the sun's image**

## **EXAMPLES OF THE APPLICATION**

### **Application in a few suns' concentration**

FIGURE 4 shows a 4 times concentration of the solar ray in PV application. It can save silicon crystal materials up to 75%. With the same area of PV, it produces more than 4 times of electricity.



**FIGURE 4: Four times concentration in PV application**

#### **Application for a few ten of suns**

This application is aiming for a new type of solar cooker. Because of target oriented tracking theory, the tracking collector and the cooker can be separated for the convenience of cooking. FIGURE 5 shows the prototype of such a device.



**FIGURE 5: Solar cooker with separate unit**

#### **Application using a few hundred suns**

At this concentration range, most of our effort was spent on the use of CPV (concentrator photovoltaic) for the terrestrial application.

Although not so popular in the market, research on concentrator photovoltaic (CPV) started in 1975. In the early time, people just expect the cell efficiency would be similar to that of flat-plate cell (PV). It turns out that the conversion rate is now much higher than originally projected.



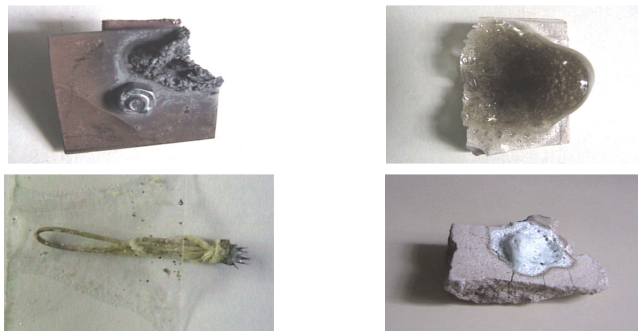
However, the CPV meets furious competition from flat-plate PV. The flat-plate is cheaper to use and not like CPV, which needs tracking and focusing devices. Therefore, the only way to win the battle is a low cost, high concentration and globally standardized sun tracking and focusing device. We are developing this optical system (see FIGURE 6) using our new theory.



**FIGURE 6: The prototype of 300 concentration using CPV**

#### **Application using ten thousand suns**

New theory has opened the door for the popular use of high concentration solar collector, the solar furnace as we named. Much attention has been paid in this respect since the invention of new heliostat. The new device has good characteristic for such a design that is not easy to be obtained by the traditional methods. With a simple set-up, we can achieve a temperature higher than  $3,500^{\circ}\text{C}$  as exhibited by the pictures below.



**FIGURE 7: Specimens for the demonstration of new solar furnace**

To reach a ten thousand concentration using low cost equipment is not an easy task. However, many new techniques has been developed recently which will lead forward a perfect design within a number of years time.



**REFERENCES**

- Chen Y. T., et al. 2001. *Non-Imaging Focusing Heliostat*”, Journal of Solar Energy, Vol. 71/3, 155-164.
- Chen Y. T., et al. 2002. *Report of the First Prototype of Non-Imaging Focusing Heliostat and Its Application in High Temperature Solar Furnace*”, Journal of Solar Energy, Vol. 72, No. 6, 531-544.
- Chen Y. T., et al. 2003. *Study of Residual Aberration of Non-Imaging Focusing Heliostat*, Journal of Solar Energy Materials and Solar Cells, Vol. 79, 1-20.
- Chen Y. T., et al. 2003. *High Precision (1 part in 10<sup>4</sup>) Reflectivity Measurement for the Study of Reflective Materials Used in Solar Collectors*, Journal of Solar Energy Materials and Solar Cells, Vol. 80, 305-314.
- Chen Y. T., et al. 2004. *Comparison of Two Sun Tracking Methods in the Applications of Heliostat Field*, Journal of Solar Energy Engineering, Vol. 126, 1-7.
- Chen Y. T., et al. 2005. *Report on the Second Prototype of Non-Imaging Focusing Heliostat and Its Application in Food Processing*, Accepted by Journal of Solar Energy, in print.
- Ries H., and Schubnell, M. 1990. *The Optics of a Two-Stage Solar Furnace*, Solar Energy Materials, 21. pp.213-217.
- Zaibel, R., Dagan E., Karni J., and Ries H.. 1995. *An Astigmatic Corrected Target-Aligned Heliostat for High Concentration*, Solar Energy Materials and Solar Cells. 37. pp.191-202.
- Geldermann J. and O. Rentz. 2004. *The reference installation approach for the techno-economic assessment of emission abatement options and the determination of BAT according to the IPPC-directive*. J. of C. Prod. 12:389-402.
- Jansen I. 2004. The 'Sevilla Process' - Best Available Techniques in surface treatment using organic solvents. 127-136. Geldermann, J. , H. Schollenberger, I. Hubert, and O. Rentz (eds.): *Integrated Scenario Analysis and Decision Support for the Modern Factory*, DFIU, Karlsruhe
- Rentz O., N.-H. Peters, S. Nunge, and J. Geldermann. 2003. *Bericht über Beste Verfügbare Techniken (BVT) in den Bereichen der Lack- und Klebstoffanwendung in Deutschland (Reports on BAT in the Sectors of Paint and Adhesive Application in Germany)*, VDI-Verlag, Düsseldorf
- Staiger B, S. Friedrich, and H.-W. Schütte. 2003. *Das große China Lexikon*. Primus Verlag, Darmstadt.
- Treitz M., H. Schollenberger, V. Bertsch, J. Geldermann, and O. Rentz. 2004. Process Design based on Operations Research: A Metric for Resource Efficiency. in: *2nd International Conference on Environmental Concerns: Innovative Technologies and Management Options*, Xiamen, P.R. China
- UNEP. 2004. *Water for the future*, UNEP: 2003 Annual Report.
- WHO. 2000. *Air Quality Guidelines for Europe*, WHO Regional Publications, Copenhagen.



## DECOLOURATION OF DYE WASTEWATER BY WHITE ROT FUNGI

Yongqian Cheng, Yongsen Lu, Dahe Jiang  
College of Environmental Science and Engineering  
Tongji University, Shanghai China

The effects of different conditions such as culture solutions, initial pH values, and carbon resource concentrations on decolouration activity of white rot fungi were studied. These factors were all found to be important for dye decolouration. Experimental conditions of carbon resource were very favourable to speed and enhance decolouration of textile dye Reactive Brilliant Red X-3B. A specific bioreactor using coal cinder as white rot fungal mycelium supporter was developed in this research and the decolouration percentage of dye was favourable. The choice of culture solution and culture initial pH value had profound effects on the dye decolouration. The use of the first culture solution indicated excellent pH control and resulted in high decolouration ability. The culture with the initial pH value of 6.0 facilitated the decolouration process.

### INTRODUCTION

People pay much concern over the discharge of dyestuff effluents because of their high colour intensity, possible toxicity and carcinogenicity even in very low concentrations in the environment (Brown, A & De Vito, 1993). Although textile and dyestuff effluents are treated in activated sludge systems, most synthetic dyes are resistant to biodegradation (Shaul, G.M. et al., 1991). The removal of colour from this type of wastewater is often more important than the removal of the soluble colourless organic substances which usually contribute the major fraction of the chemical and biochemical oxygen demand (Banat, I. M et al., 1996). Because of the complex and varied chemical structures of these compounds, there are no universally useful methods available for treatment of dye effluents. Similarly physical or chemical methods incline to be expensive or to involve removal of pollutants rather than their destruction. There is a need to develop a practical biologic method of dye waste treatment that can be used for a wide range of wastes.

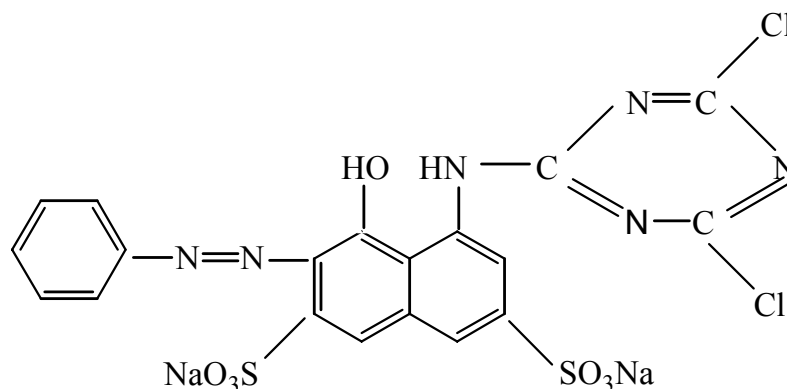
The ability of white rot fungi to degrade individual xenobiotic chemicals, many of which are recalcitrant to biodegradation, has been reported (J. Swamy & J. A. Ramsay, 1999). The decolourisation of dyes, such as phenol red, Methylene blue, Coomassie blue, Dextran blue, Poly R-478, Poly R481, Poly Y-606, and Poly B4-411 has been used to indicate ligninolytic activity (Glenn, J.K. & Gold, M.H., 1983). Most of the research on dye degradation by white rot fungi has focused on *Phanerochaete chrysosporium* (Spadaro, J.T et al., 1992). Although there are a few studies of dye decolouration by *Trametes versicolour*, this organism has been investigated for its decolouration of darkly coloured kraft and pulp mill effluents.

Azo dyes, the largest group of synthetic dyes, are produced in large quantities and mainly used in textile dyeing. Reactive Brilliant Red X-3B, a basic textile dye, is a kind of azo dyes. This paper reported studies on the utilization of a kind of white rot fungus, *Basidiomycetes*, for the decolourization of Reactive Brilliant Red X-3B. The decolouration process was investigated in a unique bioreactor using coal cinder as white-rot fungal biofilm supporter. The effects of dye decolourisation were significantly affected by the culture constitutions, initial pH values and carbon resource concentrations.

## MATERIALS AND METHODS

### Material and Stock Solution.

The analogue dyestuff waste water used in this study was Reactive Brilliant Red X-3B aqueous solution. Reactive Brilliant Red X-3B is a kind of azo dyes. Its chemical structure as follows (FIGURE 1):



**FIGURE 1: Chemical structure of Reactive Brilliant Red X-3B**

### Decolouration Experiments

Fungal strains were isolated from natural material. Fruiting bodies of basidiomycete fungi growing on rotting wood in Shanghai, China, were taken, broken, and a sample of tissue was transferred onto Sabourand dextrose agar (SDA) and incubated at 30°C until extensive mycelial growth occurred. Pure culture was maintained on SDA. After the pure culture was incubated for 5 days at 35°C in a constant temperature incubator, the culture was homogenized and used for inoculation of fresh SDA. The fungal mycelia were harvested after cultivation and then used in decolourisation experiments.

After the culture solution was sterilized at the temperature 121°C for 20min, it was used for the decolourisation. Experimental temperature was 32°C. The experimental facilities were a specific bioreactor using coal cinder as white rot fungal mycelium supporter. The bioreactor was a round column, made up of organic glass. Its diameter was 10cm and its height was 60cm. The batch decolouration was processed in the bioreactor for 96hours, then the decolourised medium was discharged and the bioreactor was eluted for another batch experiment.

### Analyses

Dye concentration was measured by UV/VIS spectrophotometer. The peak position of Reactive Brilliant X-3B was noted at 539.5nm. Samples (8ml) of culture medium were taken at 12h and then centrifuged at 3000rpm for 5 min to remove suspending particles; then pH and dye concentration were measured. Decolouration percentage was calculated from absorption values obtained against the controls. Assuming the initial absorption value was  $A_i$  and the final absorption value was  $A_f$ , the decolouration percentage =  $(A_i - A_f) / A_i \times 100\%$ .

## RESULTS

### The effect of culture solution.

Three culture solutions were studied for their abilities to maintain a constant pH during growth and decolouration in the aqueous batch experiments.

- *Culture solution one:*

15 g/L glucose(carbon source), 1.2 mmol ammonium tartrate (Nitrogen Source), 20 mmol/L sodium succinate (buffer solution), 5.0 g/L  $\text{KH}_2\text{PO}_4$ , 0.2 g/L  $\text{MgSO}_4 \cdot 7\text{H}_2\text{O}$ , 1 mg/L  $\text{VB}_1$ , 0.068 g/L  $\text{CaCl}_2$ , *Reactive Brilliant Red X-3B* 50 mg/L (final concentration);

- *Culture solution two:*

20 g/L glucose(carbon source), 0.18 g/L  $\text{NH}_4\text{NO}_3$  (Nitrogen Source), 2.5 g/L sodium citrate(buffer solution), 3.0 g/L  $\text{KH}_2\text{PO}_4$ , 0.2 g/L  $\text{NaH}_2\text{PO}_4$ , 1.5 g/L  $\text{MgSO}_4 \cdot 7\text{H}_2\text{O}$ , 0.1 mg/L  $\text{VB}_1$ , 0.1 mg/L  $\text{CaCl}_2$ , 0.1 mg/L  $\text{FeSO}_4 \cdot 7\text{H}_2\text{O}$ , 0.01 mg/L  $\text{ZnSO}_4 \cdot 7\text{H}_2\text{O}$ , 0.2 mg/L  $\text{CuSO}_4 \cdot 5\text{H}_2\text{O}$ , *Reactive Brilliant Red X-3B* 50 mg/L (final concentration);

- *Culture solution three:*

10 g/L glucose(carbon source), 1.2 mmol ammonium tartrate (Nitrogen Source), 20 mmol/L acetic acid (buffer solution), 2.0 g/L  $\text{KH}_2\text{PO}_4$ , 1 mg/L  $\text{VB}_1$ , 0.132 mg/L  $\text{CaCl}_2$ , 1.5 g/L  $\text{MgSO}_4 \cdot 7\text{H}_2\text{O}$ , Tween 80, trace elements and *Reactive Brilliant Red X-3B* 50 mg/L (final concentration);

The results showed that the decolouration of *Reactive Brilliant Red X-3B* tended to rise in the three culture solutions (FIGURE 2(a)). But the tendencies were different from each other. In the first culture, the decolouration percentage quickly reached 66.1% within initial 36 hours, later the decolouration process became slower than before, then the decolouration percentage increased. Finally 78.9% decolouration was achieved. The decolouration activity of white rot fungi in the second culture solution was remarkably different from the others. Decolouration activity was quickly processed in the initial stage (within 36 hours), then the decolouration process declined. The decolouration percentage in the third elevated increased slowly and steadily, which showed a different decolouration mechanism. As for the pH variation (FIGURE 2(b)) in the three culture solution, the pH value in the first varied slightly, showing a good buffer capacity; the pH variations in the second and third culture solution were fluctuated, compared with the first culture solution. A control experiment in three inoculated culture solutions (FIGURE 2(c)) were also carried out at the same time. The decolouration in the control experiment almost neglected. In general, the first culture solution had the best decolouration and buffer capacity.

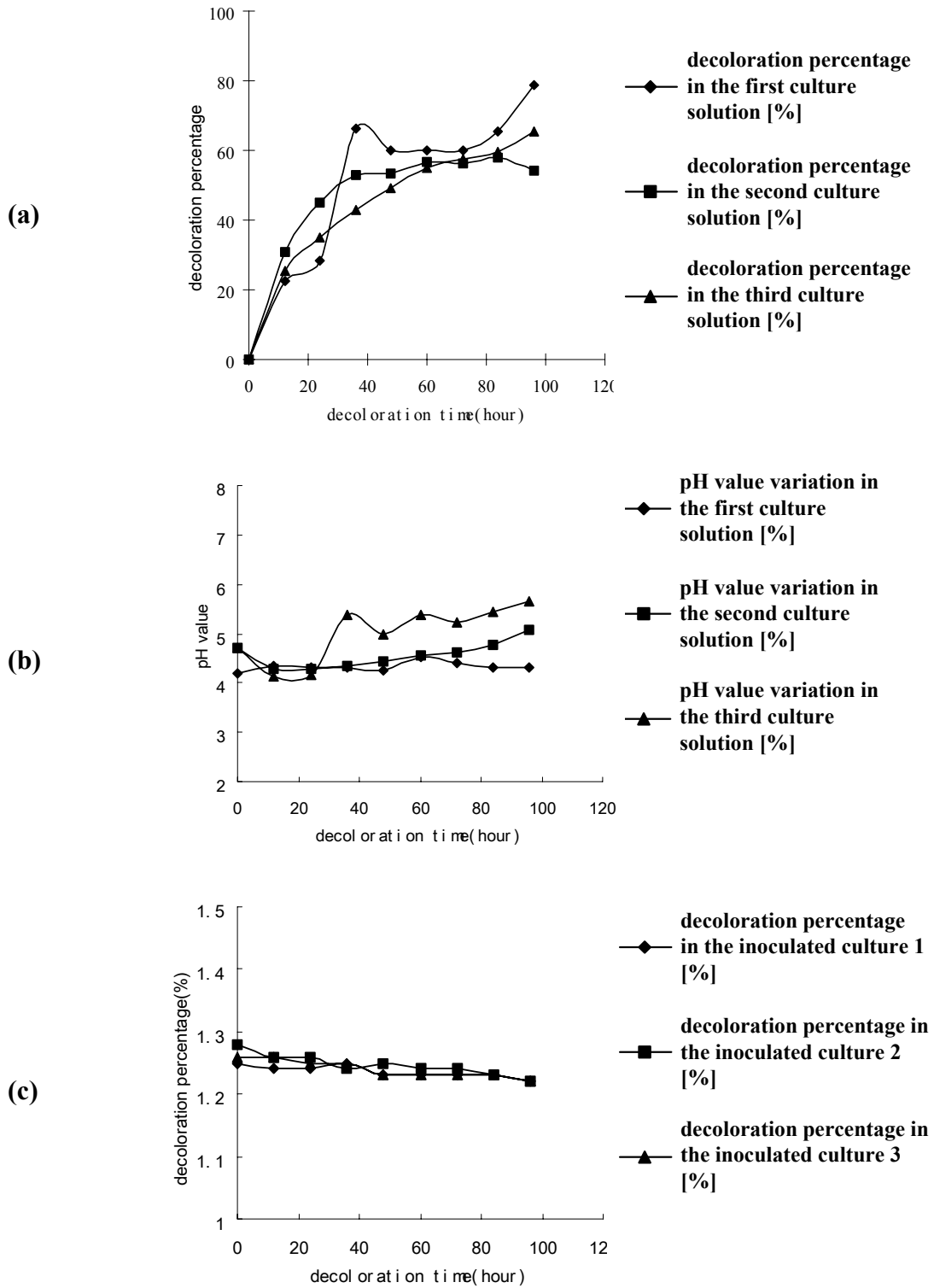


FIGURE 2:

- (a) Reactive Brilliant X-3B decolouration percentage in different culture solutions  
 (b) pH value variations of decolouration in different culture solutions  
 (c) Reactive Brilliant X-3B decolouration percentage in inoculated culture solutions

### The effect of initial pH value.

The first culture solution was used to evaluate the decolouration effect caused by the initial pH value of culture solution. The levels for initial pH for culture solution were 3.0, 4.5, and 6.0 respectively. The concentrations of ammonium tartrate were 1.2mmol/L (low nitrogen). The results were shown by FIGURE 3 (a), (b). As FIGURE 3 indicated, (1) when the initial pH value was 6.0, the decolouration of culture solution was the best among the three cultures. After 96h, the pH value of culture reached 7.0-8.0. The increase of pH value was remarkable, compared with the pH value in other two cultures. (2) In the experiment, the white rot fungi grew very quickly and well when the initial pH value of culture was 3.0. The suspending mycelium almost blocked the sampling tube. White rot fungi normally produced the lignin peroxidases and Manganese peroxidase, which acted as the crucial roles of the dye decolouration, during the secondary metabolism. Overgrowth of mycelia may result in the decrease of amount and activity of these peroxidases.

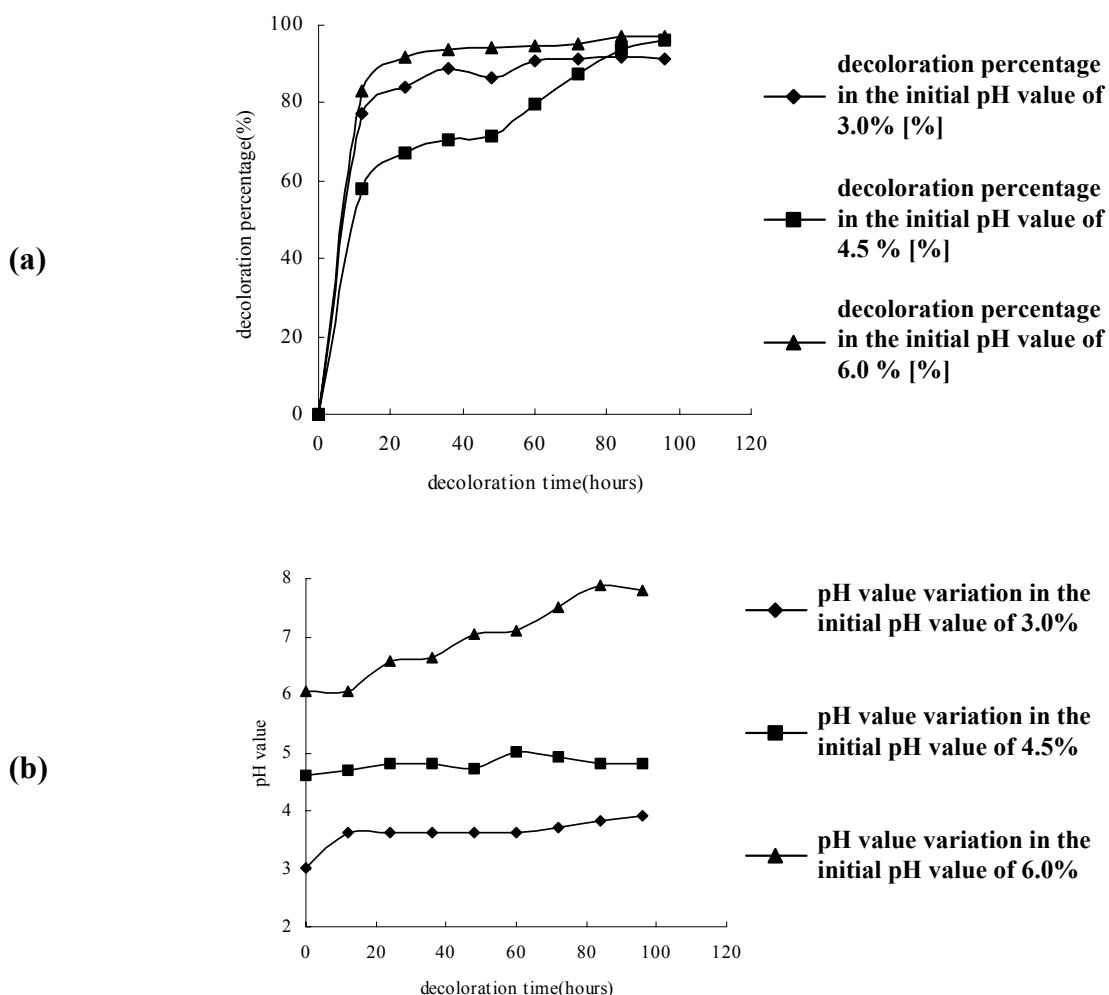


FIGURE 3:

- (a) Reactive Brilliant X-3B decolouration percentage at different levels of initial pH values
- (b) pH value variations of decolouration at different levels of initial pH values

### The effect of Glucose Source concentration

Carbon sources are very important to the growth and decolouration of white rot fungi. Three levels of glucose source in the first culture solution were tested for the decolouration process. The glucose concentrations were 0g/L (non-glucose), 0.432g/L (low glucose), 15g/L (high glucose) respectively. The glucose concentration affected the decolouration greatly (FIGURE 4 (a)). Decolouration percentage in the non-glucose culture was the lowest. The decolouration percentage in the low and high glucose culture were very close. The decolouration percentage for low glucose and high glucose were 82.7% and 80.2% respectively after 96 hours. And it was very interesting that the decolouration percentage in high glucose culture nearly attained the same decolouration percentage as in the low glucose culture when the glucose was nearly exhausted after 96 hours. As for the pH variations during the decoloration, the pH values in the low glucose culture were more stable than that in the high glucose culture.

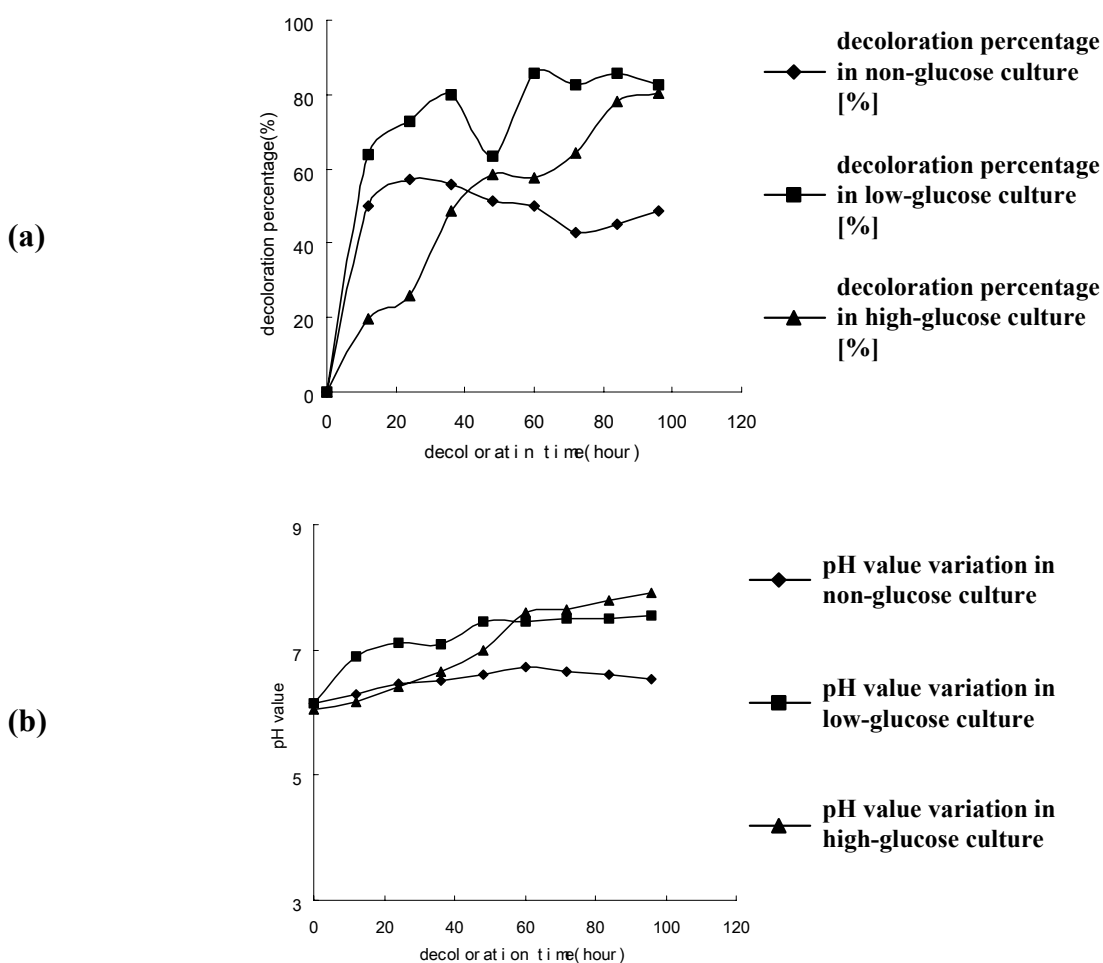


FIGURE 4:

- (a) Reactive Brilliant X-3B decolouration percentage at different levels of glucose resources
- (b) pH value variations of decolouration at different levels of glucose resources



## DISCUSSION

These experimental results confirm the previous reports of the degradative decolouration of dyestuffs by white rot fungi. They also showed the decolouration by the white rot fungi in a coal bioreactor was very favourable. The decolouration of dye was closely associated with the compositions of the culture solution. The first culture solution gave the best decolouration during the long-term operation. The decolouration process was not only affected by the contents of the culture, but also related with the culture buffer capacity. Among the three culture solutions, the buffer capacity of the first culture was best. The pH varied slightly. The pH value of the other two cultures changed from weak acid to neutrality, which maybe resulted from the specific decolouration process of white rot fungi.

Previous research reported the most favourable pH value for the growth of white rot fungi is between 4 and 5. However, the favourable pH values for yielding the peroxidases vary greatly. Our research indicated the culture facilitated the growth of white rot fungi when the initial pH value was 3.0. On the other hand, the decolouration was accelerated when the initial pH value of culture was 6.0. The effects caused the pH value of culture varied with the white rot fungi strains, the culture constitutions, and the dye structures. Many researches make clear that the low pH value in the culture can effectively prevent the bacteria or other microorganism from attacking the reaction system. Yet our experiment indicated the white rot fungi could long and steadily grow on the biofilm and became the dominating strains when the initial pH value of culture was 6.0 in an open reaction system. This is very significant for the practical application of pollutant removal.

Yu guoce (Yu guoce et al., 2003) researched the decolouration of *Phanerochaete chrysosporium* (a kind of white rot fungi) and found that activity peak of Lignin Peroxidase occurred when the carbon source (glucose) was or nearly exhausted. Our findings also demonstrated that the decolouration in the low glucose yielded the best decolouration. This maybe resulted from the reason that occurrence of Lignin Peroxidase was related with the low carbon glucose. Besides glucose, the white rot fungi are able to use other materials as carbon sources, such as glycerin, wood dust (Trevor, M. D et al., 1999), leaves, molasses (Michael, A. P et al., 1999), dye stuff, paper making effluents (Archibald F, et al., 1990), lignite (Michel, F. C., et al., 1991) and so on.

The effect of agitation and vibration was not only concerning about the types of white rot fungi, but also related with the existing shapes in the reactors. Moderate agitation in the fixed growth bioreactor facilitated the transmission of oxygen, pollutants, and enzymes so that the decolouration was accelerated. The vibration or agitation in the suspending growth culture could cause the negative effect for the lignin peroxidase production. In our experiment, the white rot fungi were fixed in a biofilm reactor. Though the aeration caused heavy agitation, the high-speed decolouration of dye was not affected.

It is well known that the removal of dyes or treatment of dye stuff is an urgent task for the sound management of the environment. The results presented in our research show the potential for the use of white rot fungi in the degradation and decolorization of dye wastewater. Processes involving white rot fungi have been proposed for the treatment of effluents from wood pulping, and they may be useful in treatment of effluents containing dyestuffs or other organic water waters.

## ACKNOWLEDGEMENT

The author acknowledges the Shanghai Educational Committee for support of this research (project no. QF57).

**REFERENCES**

- Archibald F, et al.,1990. *Decolourization of Kraft Bleachery Effluent Chormophores by Coriolus (Trametes) versicolour*. J. Enzyme and Microbial technology,12(11):846-853
- Banat, I.M., Nigam, P., Singh, D., Marchant, R., 1996. *Microbial decolourization of textile-dye-containing effluents:a review*. J.Biores.Technol.58, 217-227
- Brown, A and De Vito, S.C, 1993. *Predicting azo dye toxicity*. J. Sci. Technol. 23, 249-324.
- Glenn, J.K. and Gold, M.H, 1983. *Decolouration of several polymeric dyes by the lignin-degrading basidiomycete Phanerochaete chrysosporium*. J.Appl.Environ.Microbiol.45, 1741-1747
- J. Swamy and J .A. Ramsay, 1999. *The evaluation of white rot fungi in the decolouration textiles*. J. Enzyme Microb.Technol. 24,24:130-137
- Michael, A. P., Rosa, R. et al., 1999. *Polycyclic aromatic hydrocarbon metabolism by white rot fungi and oxidation by Corioloopsis gallica UAMH 8260 laccase*. J. Applied and Environmental Microbiology, 65(9): 3805-3809
- Michel, F.C., et.al.1991. *Role of Manganese Peroxidases and Lignin Peroxidases of Phanerochaete chrysosporium in the Decolourization of Kraft Bleach Plant Effluent*. J.Applied and Environmental Microbiol.,57(8):2368-2375.
- Spadaro, J.T Gold, M .H. and Renganathan, V.1992. *Degradation of azo dyes by the lignin-degrading fungus Phanerochaete chrysosporium*. J.Appl.Environ.Microbiol.58, 2397-2401
- Shaul. G.M., Holdworth, T. J., Dempsey, D. R., and Dostal, K. A., 1991. *Fate of water soluble azo dyes in the activated sludge process*. J. Chemosphere 22,107-119
- Trevor, M .D., Carlos, S.M., et al., 1999 *Lignin-modifying enzymes of the white rot basidiomycete Ganoderma lucidum*. J.Applied and Environmental Microbiology, 65(12): 5307-5313
- Yu guoce, Wen xianghua,et al.2003. *Formation of the ligninolytic enzymes by Phanerochaete chrysosporium under various ammonium nitrogen concentrations*. J.Acta Scientiae Circumstantiae, 23, (6): 802 — 806

# ADSORPTION OF CU(II) AND CD(II) REMOVAL FROM WATER BY WEAK BASE EPOXY ANION-EXCHANGE RESIN

Hong-mei Ma, Zhi-liang Zhu, Jian-fu Zhao

State Key Laboratory of Pollution Control and Resource Reuse,  
Tongji University, Shanghai, China

The removal of trace cadmium and copper from light-polluted water with 701 weak alkaline epoxy anion resin has been studied in this paper. Kinetic data and equilibrium removal isotherms were measured. The influence of different experimental parameters such as time contact, resin dosage, interference of alkali metals and alkaline-earth metals and temperature, on the kinetics of cadmium and copper removal was studied. The equilibrium data obtained in this study have been found to fit the Langmuir isotherm. The removal process of Cd(II) and Cu(II) follows first-order reversible kinetic. The results showed that cadmium can be perfectly adsorbed by 701 weak alkaline epoxy anion resin with high selectivity from light-polluted water, despite high concentrations of co-existed alkaline and alkaline earth metals. It was demonstrated that the above method was an effective way for the elimination of Cd(II) and Cu(II) from light-polluted water.

## INTRODUCTION

Nowadays heavy metals are among the most important pollutants and are becoming a severe public health problem. The heavy metal ions are stable and persistent environmental contaminants, they can not be biodegraded and tend to accumulate in living organisms, causing various diseases and disorders.

Current technologies for treating wastewater such as chemical precipitation, ion exchange, membrane technologies, biological processes lack a sufficiently high affinity and selectivity to reduce residual heavy metals to the levels dictated by ever more stringent government regulations, especially for the drinking water resources of high concentration alkali metals and alkaline-earth metals. Furthermore, the useful mineral substances of the drinking water are also lost while the technologies are adopted to remove the toxic and poisonous heavy metals. This situation has in recent years led to a growing interest in the seek of safe, high efficiency technology for the removal of trace amounts of toxic metals from high concentration alkali metals and alkaline-earth metals.

Weak base anion-exchange resin is an alternative technique for removing trace heavy metals from raw waters, based on the property of a certain class of resin to accumulate heavy metals through complexing action. Weakly basic anion exchange resins carries amino group and behaves as a Lewis base, they can undergo coordination bonds with Lewis acids like heavy metal. It is possible to achieve selective separation and recovery of heavy metals with low energy requirements. The selective uptake of heavy metals by weakly basic anion resin has been known since about 1970 (Holl W H, 1996.) and has been explored by several researchers. Tsinghua university has made some research in this field and achieved some useful results in technique application (X. Zhao, et al., 2002; G. C. Tong & G. C. Yun, 2000; G. C. Tong, et al., 2000; S.J. He, et al., 2002). Our present research indicates that the adsorption of the epoxy resin are superior to the adsorption effectiveness of styrene resin and acryl acid resin.

In the present paper, 701 epoxy weakly basic anion exchange resin was examined for the elimination of Cd(II) and Cu(II) present in light-polluted water for different conditions. The parameters that influence adsorption process, such as initial concentration, resin dosage, the pH in solution and contact time has been examined. The equilib-

rium and kinetic process has also been characterized at 25 °C. The existing results may contribute to obtain the basic information for the design of sorption equipment.

## MATERIALS AND METHOD

### Materials and reagent

The 701 epoxy weakly basic anion exchange resin was obtained from. Its properties is given by the manufacturers is listed as follows( TABLE 1). For the experiments, the resin was first pretreated with 0.05 mol/L sulfuric acid and 0.05 mol/L sodium hydroxide to remove impurities from its synthesis. After extensive rinsing with demineralized water the exchanger was applied for the further experiments.

Stoke solutions of 1000mg/L of Cd(II) chloride, Cu(II) sulfate were prepared in demineralized water. All chemicals were commercial products used without purification.

**TABLE 1: Characteristics of the 701 weakly anion resin**

Characteristics	Values
Matrix	Epoxy propane
Functional groups	-C <sub>2</sub> H <sub>4</sub> NH <sub>2</sub> - C <sub>2</sub> H <sub>4</sub> NHR -C <sub>2</sub> H <sub>4</sub> NR <sub>2</sub> - C <sub>2</sub> H <sub>4</sub> NR <sub>3</sub>
Particle size[mm]	0.3~2.0
Moisture holding capacity[%]	64-72%
Density[g/L <sup>-1</sup> ]	650-800
Swelling [%]	25

### Apparatus

An atomic absorption spectrometer(AAS)(Shimadzu, AA-6501)was used for quantitative determination of the concentration of Cu(II) and Cd(II). The AAS was equipped with a deuterium lamp, background correction, a hollow cathode lamp, and an air-acetylene burner. pH was measured using a glass electrode(Shanghai,pHs-29A). An electrical temperature-controlled shaker was used for shaking.

## PROCEDURES

### Uptake kinetic of metal

For metal ions-removal kinetic studies, 1.0g of 701 weak base anion-exchange resin was added in 200mL of 1mg/L Cd<sup>2+</sup> and Cu<sup>2+</sup> solutions, the solutions were agitated for a pre-determined period at 25±1 in a shaking incubator. In all cases, the working pH was that of the solution and was not controlled. At appropriate time intervals, stirring was briefly interrupted while 5mL volumns of supernatant solutions were pipetted from the reactor and were analyzed by atomic adsorption spectrophotometer for the residual Cd<sup>2+</sup> and Cu<sup>2+</sup> content. The metal ions uptake  $q$ (mg ion metal/g resin) was determined as follows:

$$q = (C_0 - C_t) \times V / m$$

where  $C_0$  and  $C_t$  are the initial and final metal ions concentrations (mg/L), respectively,  $V$  is the volume of solution (mL), and  $m$  is the resin weight (g) in dry form.

Preliminary experiments had shown that cadmium adsorption losses to the container walls was negligible.

### Uptake isotherm of metal

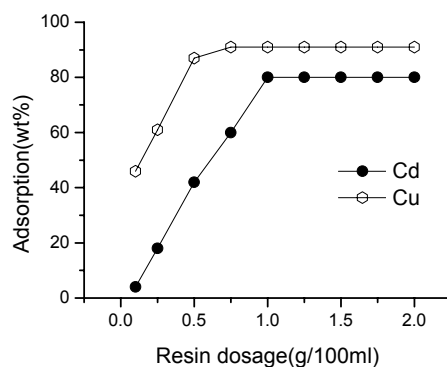
The equilibrium isotherms were determined by contacting a constant mass(0.1g) of 701 weak base anion-exchange resin with a range of different concentration of cadmium solutions. The resin and cadmium solutions were agitated in a series of 250mL conical flasks with equal volumes of solution (100mL) for a period of 24h at room temperature. The contact time was determined by kinetic tests using the same conditions. The reaction mixture pH was not controlled after the initiation of experiments. After shaking the flasks for 24h, the final pH was measured, and a solution sample was removed from the reaction mixtures after decantation. The final concentration of unbound cadmium was determined by AAS and the cadmium loading by 701 weak base anion-exchange resin was calculated.

## RESULTS AND DISCUSSIONS

All batch sorption experiments reported here were investigated at the initial pH value approach of 7, which was the true pH value of drinking water resources.

### Effects of resin dosage

The removal of Cd(II) and Cu(II) as a function of the resin dosage by 701 weak base anion-exchange resin shows as follows (FIGURE 1). The resin dosage was varied from 0.5 to 2.0g and equilibrated for 24h. The experimental results revealed that Cd(II) and Cu(II) removal efficiency increases up to the optimum dosage beyond which the removal efficiency has no change with the resin dosage. As expected, the equilibrium concentration decreases with increasing adsorbent doses for a given initial solute concentration, because for a fixed initial solute concentration, increasing adsorbent doses provide greater surface area or adsorption sites.

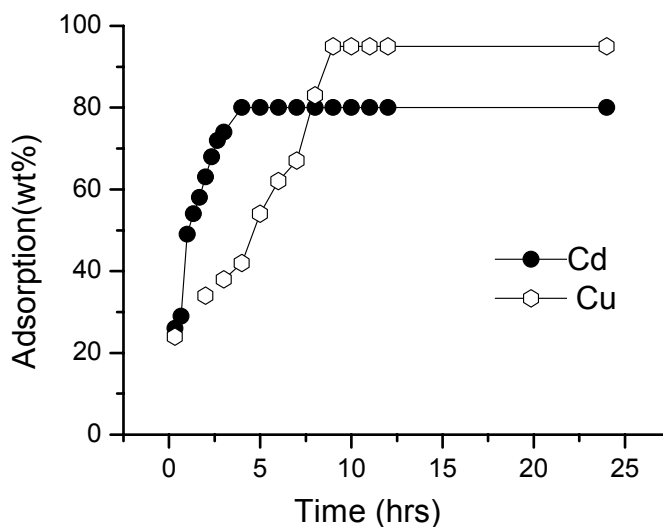


**FIGURE 1: The effect of resin dosage on the adsorption of Cd(II) and Cu(II) on the 701 epoxy resin**

### Effects of contact time

The effect of time on the absorption of metal ions by 701 weak base anion-exchange resin was studied by taking 0.5g resin with 200mL of a metal salt solution of a metal ion in different stopped flasks. The flasks were shaken for different time intervals in a temperature-controlled shaker. The effect of contact time on the removal of Cd(II)

and Cu(II) by 701 weak base anion-exchange resin shows by FIGURE 2. With the same initial concentrations of 1mg/L for Cd (II) and Cu (II), The removal efficiency increases within 9h and 4h respectively. The equilibrium time was independent of initial metal ion concentration. The metal uptake vs time curves are monotonously increasing to saturation, suggesting the possible monolayer coverage of metal ions on the surface of the adsorbent(Ho YS, et al,1995.)



**FIGURE 2: The effect of the contact time on the removal of Cd(II) and Cu(II) by the resin**

### Adsorption isotherm

The equilibrium removal of the cadmium ions and the copper ions investigated can be mathematically expressed in terms of the adsorption isotherm. The adsorption data are commonly fitted to the Langmuir model or the Freundlich model.

The Langmuir equation was applied to the adsorption equilibria for 701 weak base anion-exchange resin:

$$(C_e/q_e) = 1/(Q_0b) + C_e/Q_0$$

Where  $C_e$  is the equilibrium concentration(mg/L),  $q_e$  the amount adsorbed at equilibrium (mg/g),  $Q_0$  and  $b$  the Langmuir constants related to adsorption capacity and energy of adsorption, respectively. The linear plots of  $C_e/q_e$  vs  $C_e$  shows that the adsorption obeys the Langmuir model for both Cd(II) and Cu(II)( FIGURE 3).  $Q_0$  and  $b$  were determined from the Langmuir plots and found to be 22.32 mg/g and 0.081 g/mg for Cd(II); and 83.33 mg/g and 3.24 g/mg for Cu(II). The ratio of the  $Q_0$  values of Cu(II) and Cd(II) works out to be 3.73:1, implying the ion-exchange capacity of Cu(II) is much higher than that of Cd(II).

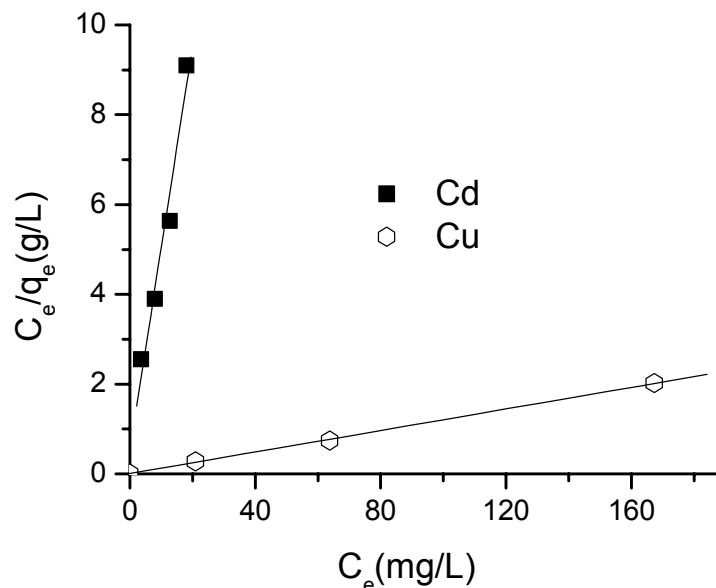


FIGURE 3: Sorption isotherm of Cd(II) and Cu(II) onto 701 epoxy resin

#### Interferences of alkine metals and alkine-earth metals

In order to evaluate the feasibility of the 701 weak base anion-exchange resin on the heavy metal ions removal from co-existed alkali metal and alkali earth metal, the influences of the matrix ions of the natural waters ( $\text{Na}^+$ ,  $\text{K}^+$ ,  $\text{Ca}^{2+}$ ,  $\text{Mg}^{2+}$ ,  $\text{Cl}^-$ ,  $\text{SO}_4^{2-}$ ) on the removal of  $\text{Cd}^{2+}$  and  $\text{Cu}^{2+}$  on 701 weak base anion-exchange resin was investigated. Preliminary analyses indicated that competition with regard to  $\text{Na}^+$ ,  $\text{K}^+$ ,  $\text{Ca}^{2+}$  and  $\text{Mg}^{2+}$  was not significant when the concentration of  $\text{Na}^+$ ,  $\text{K}^+$ ,  $\text{Ca}^{2+}$ ,  $\text{Mg}^{2+}$  were as much as one hundred times high than the concentration of  $\text{Cd}^{2+}$  and  $\text{Cu}^{2+}$ . It proved that the removal of  $\text{Cd}^{2+}$  and  $\text{Cu}^{2+}$  is not an exchange of ions but a mere complex action. We also found that increased concentration of  $\text{Cl}^-$ ,  $\text{SO}_4^{2-}$  enhance the adsorption of  $\text{Cd}^{2+}$ , which is in accord with the previous report. (Namasivayam C & Renganathan K, 1995.) The results are desired in view of applications to the natural water samples with the high salt content.

#### Adsorption kinetics

Kinetics of heavy metals adsorption can be modeled by the first-order Lagergren equation, the pseudo second-order rate equation and the second-order rate equation shown below as Eqs.(1)-(3) (Benguella B & Benaissa H, 2002.), respectively:

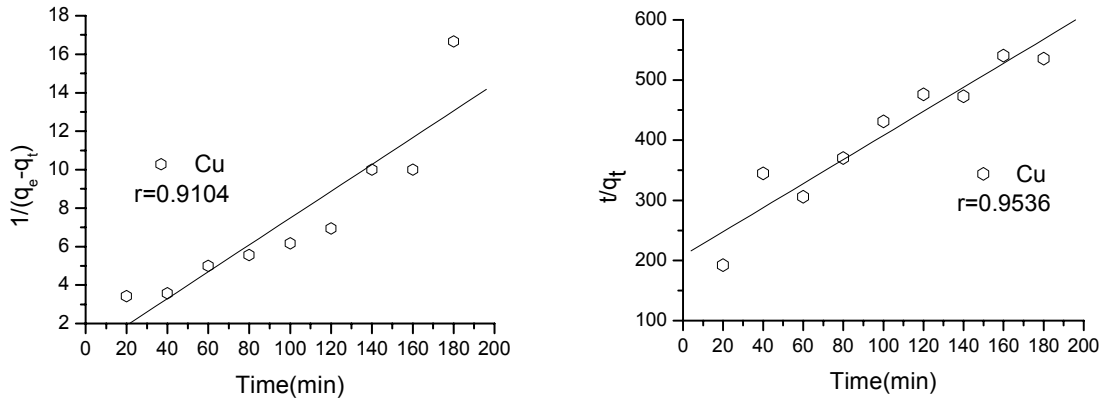
$$\log(q_e - q_t)/q_e = -K_L t / 2.3 \quad (1)$$

$$1/(q_e - q_t) = 1/q_e + kt \quad (2)$$

$$t/q_e = 1/2K'q_e^2 + t/q_e \quad (3)$$

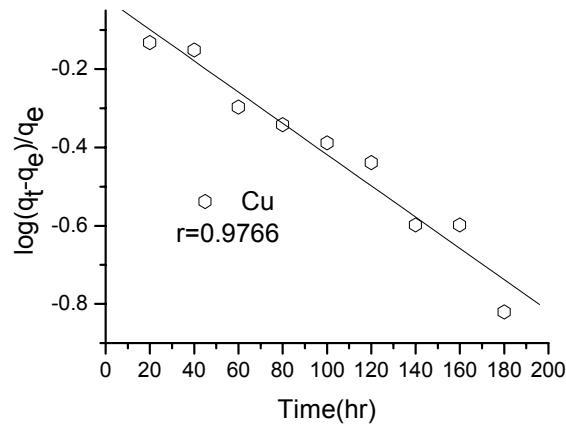
Where  $K_L$  is the Lagergren rate constant of adsorption( $\text{min}^{-1}$ );  $K'$  the pseudo second-order rate constant of adsorption( $\text{g/mg/min}$ ) and  $k$  the rate constant( $\text{g/mg/min}$ );  $q_e$  and  $q_t$  are the amounts of metal ion sorbed( $\text{mg/g}$ ) at equilibrium and at time  $t$ , respectively.

Linear plots of  $\log(q_e - q_t)/q_e$  vs.  $t$ ,  $t/q_e$  vs.  $t$  and  $1/(q_e - q_t)$  vs.  $t$  for Cu(II) are shown by FIGURE 4(a) (b) and (c). The results showed that the kinetics of Cu(II) adsorption on 701 weak base anion-exchange resin followed first-order.



(a) Second-order rate kinetics plot

(b) pseudo second-order rate

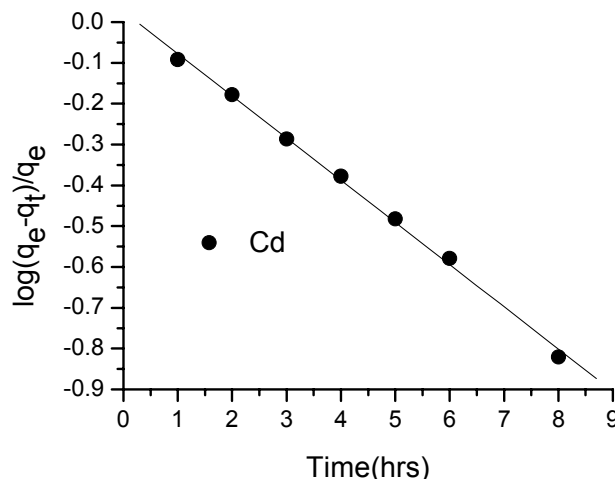


(c) first-order rate (Lagergreen plot)

**FIGURE 4: Linearisation of copper sorption kinetics by 701 weak base anion-exchange resin**

Linear plots of  $\log(q_e - q_t)/q_e$  vs.  $t$  vs.  $t$  for Cd(II) is also shown by FIGURE 5. The results also indicated that the kinetics of Cd(II) adsorption on 701 weak base anion-exchange resin followed first-order reversible kinetic.

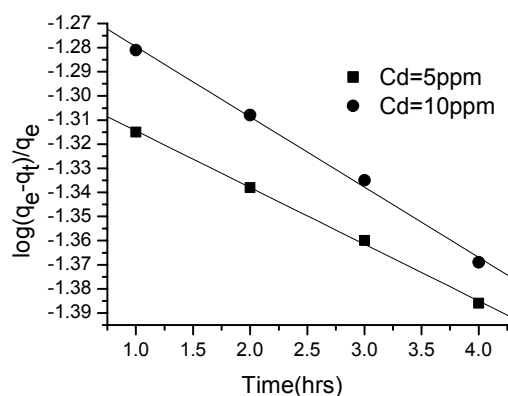




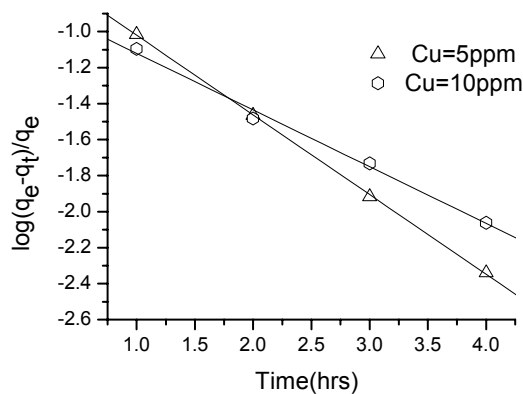
**FIGURE 5: Linearisation of cadmium sorption kinetics by 701 weak base anion-exchange resin**

#### Effect of initial metal ions concentration

Several experiment were undertaken to study the effect of varying the initial metal ions concentration on the metal ions-removal kinetics from the solution. The results obtained are shown by FIGURE 6(a), (b), and indicate that the obtained curves have the same shape. The rate constants calculated from their intercepts were found to be  $9.0 \times 10^{-4}$  ( $R^2=0.9987$ ) and  $1.11 \times 10^{-3}$  ( $R^2=0.9965$ ) at 5 and 10 mg/L, respectively, for Cd(II); and  $1.69 \times 10^{-2}$  ( $R^2=0.9997$ ) and  $1.21 \times 10^{-2}$  ( $R^2=0.9934$ ), respectively, for Cu(II).



**(a) Effect of initial cadmium concentration**



**(b) Effect of initial copper concentration**

**FIGURE 6: The first-order rate kinetics plots for Cd(II) and Cu(II) by 701 epoxy resin for different initial concentration**

#### CONCLUSIONS

The present work demonstrates that 701 weak alkaline epoxy anion resin are capable of selectively removing cadmium and copper from light-polluted water, despite high concentrations of co-existed alkaline and alkaline earth metals. Elevated concentrations of chloride ions have only negligible influence on the uptake of cadmium and copper. While the adsorption process obeys the Langmuir adsorption isotherm in equi-

librium, the kinetic of adsorption of cadmium and copper follow first-order reversible kinetics. The removal capacity of cadmium ion and copper ions are 22.32 and 83.33mg/g, respectively. And at the different initial concentration, the kinetic of adsorption of cadmium and copper also follow first-order reversible kinetics. The rate constant of Cu(II) is much then that of Cd(II). The results also demonstrate that the removal of Cd(II) and Cu(II) is not an exchange of ions but a mere complex action. The kinetic data would be useful for the fabrication and designing of wastewater treatment plants.

#### ACKNOWLEDGEMENT

The author acknowledges the State Key Laboratory of Pollution Control and Resource Reuse, China and my adviser, Professor Zhu Zhi-liang, kindly instructed me to fulfill the experiment successfully.

#### REFERENCES

- Benguella B and Benaissa H. 2002. *Cadmium removal from aqueous solutions by chitin : Kinetic and equilibrium studies*. Water Res. 36 (10):2463-2474
- G. C. Tong and G. C. Yun. 2000. *Removal of heavy metals and organic contaminants from micropolluted drinking water supplies*. J Tsinghua Univ (Sci &Tech): 12(40):67-70
- G. C. Tong, G.Y. Jin and G. C. Yun. 2000. *Removal of heavy metals and organic contaminants from micropolluted drinking water by weakly basic anion exchange resins*. Water & Wasterwater. 3(26):9-11
- Holl W H. 1996. *Elimination of heavy metals from water by means of weakly basic anion exchange resins*. Proc. IEX'96, Soc of Chem, Harrwells Ltd. Bodmin, UK.
- Ho YS, John Wase DA and Forster CF. 1995. *Batch nickel removal from aqueous solution by sphagnum moss peat*. Water Res. 29 (7):1327-32
- Namasivayam C and Renganathan K. 1995. *Removal of Cd( II) from wastewater by adsorption on waste Fe( III)/Cr( III) hydroxide*. Water Res. 29 (5): 1737-1744.
- S.J. He X. Zhao and Y.C. Ye. 2002. *Removal of Cr(VI) from drinking water by weak base anion exchange resin*. J Tsinghua Univ (Sci &Tech). 5(42) 662-664
- X. Zhao, Holl W H and G. C. Yun. 2002. *Elimination of cadmium trace contaminations from drinking wate*. Water Res. 36 (4): 851-858

# **SIMULATION OF POLICY INCENTIVES TO PROMOTE CLEANER PRODUCTION IN AN ALCOHOL DISTILLERY**

**Zheng Wei, Cunkuan Bao, Surong Guo, Yongsen Lu**

College of Environmental Science & Engineering, Tongji University, Shanghai, China

The government policies i.e. subsidies, natural resource and energy price, discharge fees, etc. are important incentives to promote cleaner production. In this paper, the system dynamics was used as a tool to simulate the interaction of policy variation and the profits of cleaner production in an alcohol distillery (AD). The results are heuristic for government policy maker.

## **INTRODUCTION**

Cleaner production (CP) is the pile stone for sustainable economy. The government plays an important role in promoting CP in manufactural sectors. Practicing cleaner production in an enterprise is a process to unify the environmental protection and economic benefits and pave the way towards the sustainable industry .

The paper describes the roles of governmental policy and regulation on cleaner production in alcohol distillery (AD). The effects of the policies on the benefits of practicing cleaner production in the enterprise were simulated using a software of system dynamics through changing policy parameters.

## **THE PRACTICE OF CLEANER PRODUCTION IN AN ALCOHOL DISTILLERY AND THE MODEL OF SIMULATION**

### **The practice of cleaner production in an alcohol distillery**

The AD plant chosen for this case study produced 45,000 tons of alcohol in 2003, taking cassava as the raw materials. The enterprise composed of three processes which were alcohol production, cogeneration of electricity and steam, and distillage digestion and wastewater treatment, which were connected closely. High economic benefits and emission reduction were gained through the material recycling, energy cascading or improving production process and reusing by-products in the plant. In alcohol production process the best level of cassava input was attained with efficiency of carbon use. The distillage digested into methane and hydrogen which are the fuel for cogeneration power station and equal to twenty thousand tons of equivalent coal saved per year. The sequenced batch reactors (SBRs) of activated sludge process were used for further treatment of the effluent from distillage digester. Meantime twenty thousand tons of compressed CO<sub>2</sub> in food grade were supplied to market.

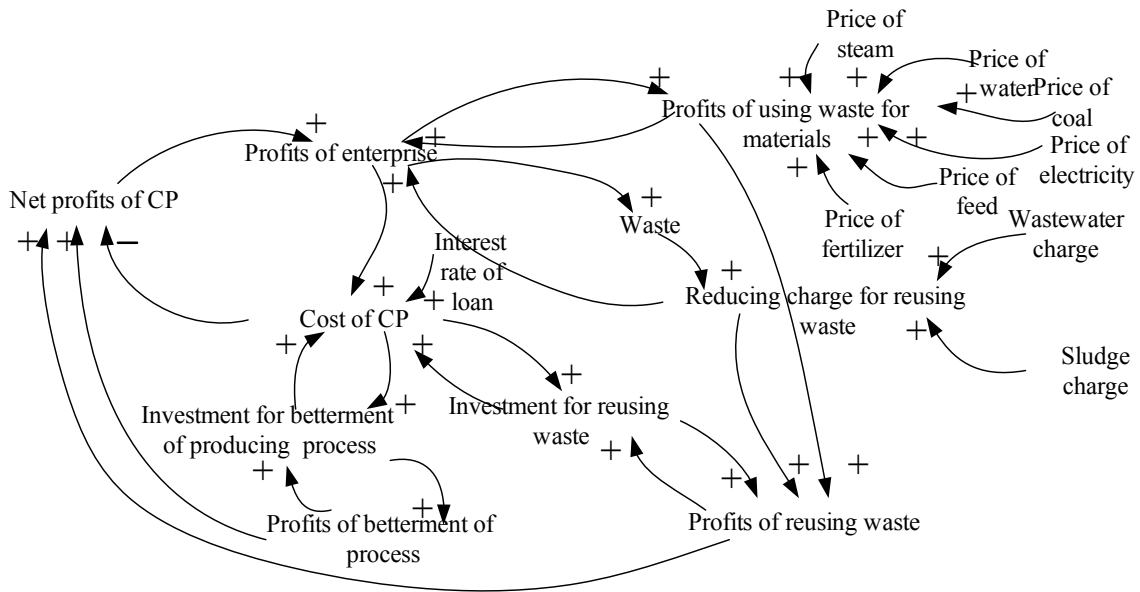
### **The model of CP system dynamics**

A simulation of policy incentives was made by a three-level modelling using System Dynamics for CP system of alcohol distillery, which can be divided into several subsystems e.g. cooling water, processing wastewater, sludge; the corresponding level variables are CWT, WT, WS, etc. Each subsystem interacts through the coupling to form a feedback loop. The main feedback chart of the model was shown as Fig.1.

## **THE SIMULATION OF POLICIES AND MEASURES**

The cost to bring about the regulatory environmental objectives by means of administrative order usually is much higher than that of economic leverage because the

environmental administration has to collect and analyses detail information on the lost of abiding in enterprises. On contrary government establishes economic policies based on motivating cleaner production (CP) in enterprises, which may not only protect the environment but also decrease the cost of governmental managements.



**FIGURE 1: Primary feedback chart of CP and policy factors**

The policy factors or measures to promote CP were classified in TABLE 1.

**TABLE 1: The classification of policy factors to promote cleaner productions in AD**

policy maker	training	resource of financing	favourable tax	accelerated depreciation	government subsidies	favourable loan	price of compressed CO2	water fee	wastewater charge	price of raw material	price of electricity	price of coal	price of steam	lees and sludge charge	cleaner production
state government	√	√	√	√	√	√	√	√	√	√	√	√	√	√	√
local government	√	√	√	√	√	√		√	√		√		√	√	√
enterprise	√	√					√	√		√			√		√

### Government Subsidies

The AD invested in construction of technology innovation and waste to energy projects respectively 30 million RMB and 55 million RMB. The depreciation time was 10 years, net depreciation rate was 5%, corresponding depreciation expenses of each year were 2.85 million RMB and 5.225 million RMB, and running cost was 4 million RMB and 5 million RMB. The results of simulation are shown TABLE 2.

**TABLE 2: Profits of CP (10,000 RMB/a)**

Year	2006	2007	2008	2009	2010	2011	2012	2013	2014	2015
Profits of CP	3,276	3,877	4,501	4,970	5,773	6,041	6,312	6,333	6,352	7,412
Net profits of CP	1,568	2,169	2,794	3,263	4,065	4,333	4,605	4,625	4,645	5,705
Profits of reusing waste	593	1,194	1,819	2,268	2,968	3,254	3,525	3,545	3,565	4,549
Profits of investment	2,682	2,682	2,682	2,702	2,707	2,707	2,707	2,707	2,707	2,863

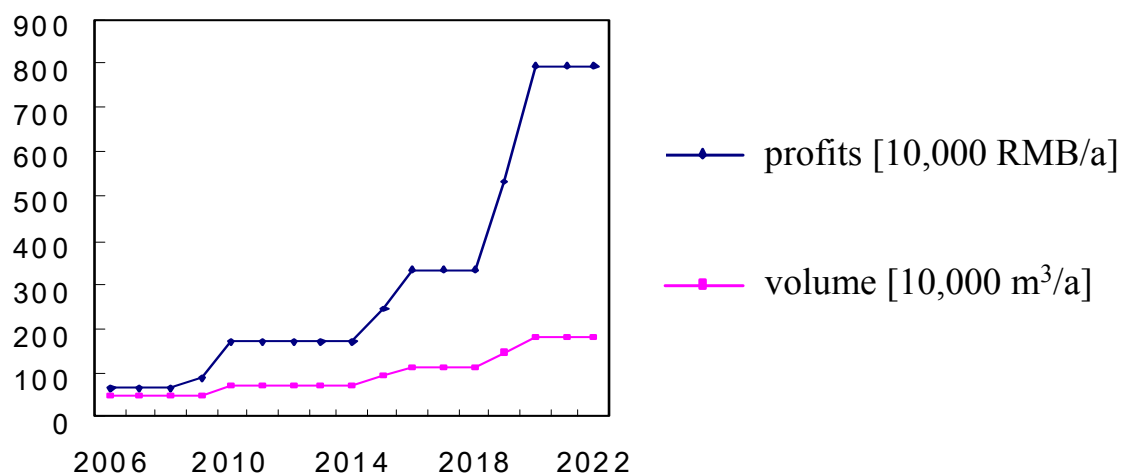
If all the funds were raised independently by the AD, the refund period would be by the year of 2008.

The huge investment of capital construction and equipment is always the main obstacle of practicing CP in an enterprise. The government subsidies, such as low interest loan, accelerated depreciation, etc. could help the AD more easily to construct the project and earlier to obtain economic and environmental benefits.

### Water resource and pollution charge

The AD consumes a great quantity of water and discharged wastewater and sludge. Government may change water fee and pollution charges to promote CP.

Raising the fee of cooling water intake and discharge can encourage recycling rate of cooling water in the AD. The charge rate in the model was assumed in Table 3. The volumes and profits of cooling water recycling are shown in FIGURE 2. It is obvious that with the rising of rates, the profit rise is bigger than that of volumes.



**FIGURE 2: Predictions on the volumes and profits of cooling water recycling**

**TABLE 3: Rates of fees and charges of cooling water (RMB/m<sup>3</sup>)**

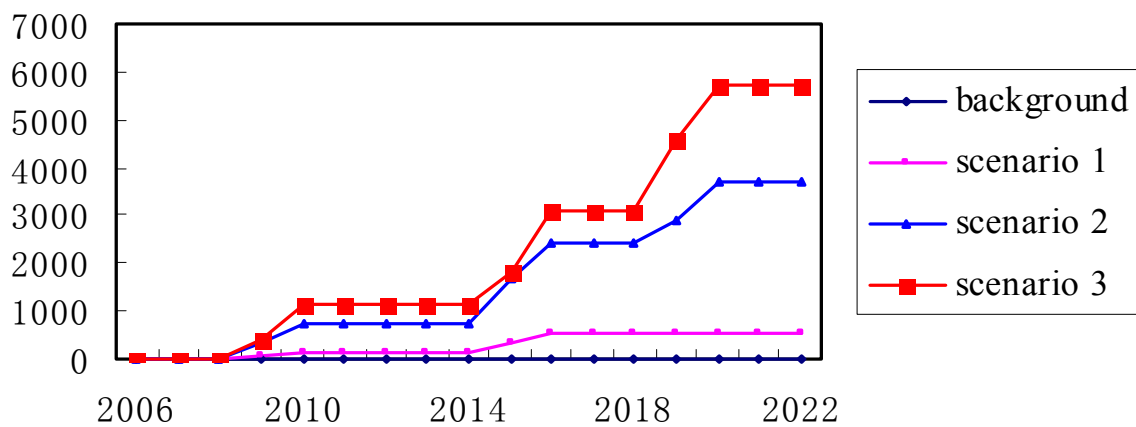
Year	2006	2008	2010	2012	2014	2016	2018	2020	2022
<b>Fees of water intake</b>	0.8	0.8	1.2	1.2	1.2	1.5	1.5	2	2
<b>Charges of wastewater</b>	0.7	0.7	1.2	1.2	1.2	1.5	1.5	2.4	2.4

The profits of water reuse in different rates of water fees and wastewater charge were simulated in different scenarios. The profits of wastewater reuse are shown in FIGURE 3, and the rates are shown in TABLE 4.

**TABLE 4: Rates of charging of producing water**

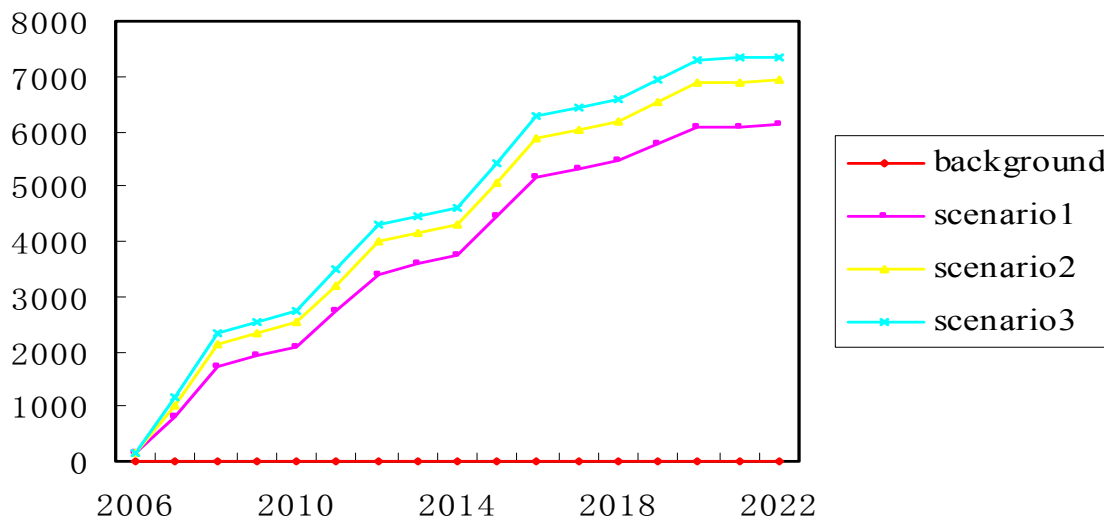
Scenario	Index	2006	2008	2010	2012	2014	2016	2018	2020	2022
<b>Scenario 1</b>	<b>water price</b>	1.4	1.4	2	2	2	3	3	4	4
	<b>wastewater charge</b>					1				
<b>Scenario 2</b>	<b>water price</b>					1.4				
	<b>wastewater charge</b>	1	1	1.8	1.8	1.8	3	3	4	4
<b>Scenario 3</b>	<b>water price</b>	1.4	1.4	2	2	2	3	3	4	4
	<b>wastewater charge</b>	1	1	1.8	1.8	1.8	3	3	4	4

From FIGURE 3 the rates of scenario 2 was larger than that of scenario 1, that showed the obvious effect of wastewater charge on the profits. Therefore if government practice stepped water price or raise wastewater charge, enterprises will more actively practice wastewater reuse to gain profits.

**FIGURE 3: Predictions on the profits of recycle of wastewater in different scenarios [10,000 RMB/a]**

### Solid waste fees

The AD produced a plenty of lees and sludge. There are a lot of microzyme, edible fibre and starch in these solid wastes. Dried lees can be made into feedstuff, and other solid wastes can be burned as fuel.



**FIGURE 4: Predictions on the profits of lees and sludge of different scenarios**

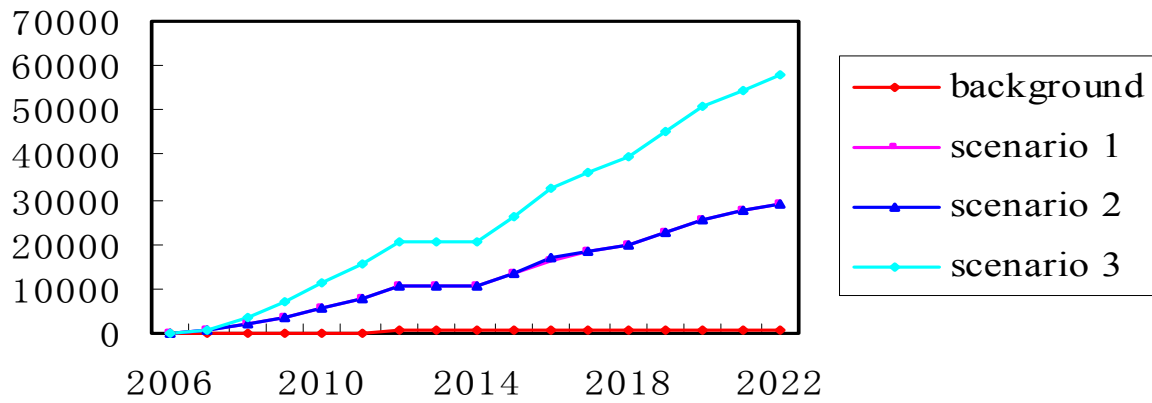
Government can encourage enterprises to solid waste reuse by raising solid waste charge. Different scenarios could be set by changing discharge fees and reuse rates of solid wastes. The solid waste charges of four scenarios were 25, 25, 50 and 70 RMB/t. The profits of reuse solid waste are shown in FIGURE 4.

### Energy price

Alcohol production uses great amount of electricity. The biogas produced in the lees liquid digestion could generate electricity, and save much cost for electricity. Raising the electricity price will encourage enterprises to take full advantage of CP. The price of electricity of four scenarios was 0.76, 0.76, 0.76, 1.52 RMB/kWh, and the price of steam were 30, 30, 60, 60 RMB/m<sup>3</sup>. In the four scenarios, coal price, proportion of biogas for different usage, and the profits of biogas are shown respectively in TABLE 5, TABLE 6 and FIGURE 5.

**TABLE 5: The coal price of different scenarios (RMB/m<sup>3</sup>)**

Year	2006	2008	2010	2012	2014	2016	2018	2020	2022
Scenario 1	700	750	820	880	930	990	1060	1140	1200
Scenario 2,3,4	700	800	900	1000	1100	1200	1300	1500	1700



**FIGURE 5: Predictions on the profits of biogas in different scenarios [10,000 RMB/a]**

**TABLE 6: Proportion of biogas for different usage in scenarios**

Year		2006	2008	2010	2012	2014	2016	2018	2020	2022
<b>Background</b>	<b>Generating electricity</b>	0	0.2	0.3	0.35	0.37	0.39	0.4	0.4	0.55
	<b>Burning</b>	1	0.8	0.7	0.65	0.63	0.61	0.6	0.6	0.45
	<b>Producing steam</b>	0	0	0	0	0	0	0	0	0
<b>Scenario 1,2,3</b>	<b>Generating electricity</b>	0	0.15	0.2	0.2	0.25	0.25	0.3	0.3	0.3
	<b>Burning</b>	1	0.8	0.65	0.6	0.55	0.5	0.4	0.35	0.3
	<b>Producing steam</b>	0	0.05	0.15	0.2	0.2	0.25	0.3	0.35	0.4

FIGURE 5 shows that the raise of coal price by government policy can increase the profits of biogas burning. Price of steam is one of the key factors in using biogas as a fuel because the enhancing extent of scenario 3 is bigger than that of scenario 2. The price of steam and electricity obviously affect the profits of biogas.

## CONCLUSION

It is feasible and effective to use System Dynamics to simulate the effect of policy-changing on the profits of CP in AD from the above simulation and analysis. It can be a reference for the government and stake holders to formulate policies on promoting CP in manufacturers. The results showed that raising policy factors would active impetus for enterprise to practice cleaner production (CP). These policies include: government subsidies or low interest loan to support enterprise's huge investment on CP facility, the regulation of stepped water fee, reasonable wastewater and solid waste charge and energy price. Appropriate market prices, e.g. coal and steam price would also be the incentives for CP.

## REFERENCES

- Zhu Shenlin(2001). An Introduction to Cleaner Production, Beijing, *Chem Ind Press*,10-28  
Professional Dynamo Plus, version 2.1, a product of Pugh-Roberts Associates, Inc.1980  
Ma Zanhua(2003). New High Efficiency Technics for Alcohol Cleaner Production, Beijing: *Chem Ind Press*:159-180  
Zhang Kechang, Wu Peizong (1989). Handbook of Alcohol Industry. Beijing: *Light Industry Press*:283-322



Frank S. Arnold, *Economic Analysis of Environmental Policy and Regulation*, New York: John Wiley & Sons, Inc., 1995: 236~237

Wang Mingyuan (2004). *Discussion of Law of Cleaner Production*. Beijing: Tsinghua University Press.:1-20

Law of the People's Republic of China on the Promotion of Cleaner Production. Enacted on June 29, 2002

the Prior Item Plan of China Agenda 21 (Part of adjusting and supplement ):3-2D the model development and alcohol distillery cleaner production. <http://www.acca21.org.cn>

Treasury Department: Financing System of Industrial Enterprises. No.(92) 574 Financing



