

OPTIMAL DIVIDEND-PAYOUT IN RANDOM DISCRETE TIME

HANSJÖRG ALBRECHER, NICOLE BÄUERLE, AND STEFAN THONHAUSER

ABSTRACT. Assume that the surplus process of an insurance company is described by a general Lévy process and that possible dividend pay-outs to shareholders are restricted to random discrete times which are determined by an independent renewal process. Under this setting we show that the optimal dividend pay-out policy is a band-policy. If the renewal process is a Poisson process, it is further shown that for Cramér-Lundberg risk processes with exponential claim sizes and its diffusion limit the optimal policy collapses to a barrier-policy. Finally, a numerical example is given for which the optimal bands can be calculated explicitly. The random observation procedure studied in this paper also allows for an interpretation in terms of a random walk model with a certain type of random discounting.

1. INTRODUCTION

The identification of optimal pay-out schemes for dividends to shareholders in an insurance context is a classical problem of risk theory. Given a stochastic process describing the surplus of an insurance portfolio as a function of time, it is a natural question at which points in time and to which amount dividends should be paid out to the shareholders. These pay-outs then reduce the current surplus. A popular optimality criterion is to maximize the expected total sum of discounted dividend payments until ruin (i.e. the dividend payments stop as soon as the surplus becomes negative for the first time). This problem was studied over the last decades under increasingly general model assumptions. Extending earlier work of de Finetti [7], Gerber [8] showed that if the surplus process is modeled by a random walk in discrete state space, then a so-called band-policy maximizes the expected sum of discounted dividend payments until ruin. He then also established this result for a continuous-time surplus process of compound Poisson type with downward jumps, and showed that in case of exponentially distributed claim sizes this optimal band-policy collapses to a barrier-policy, i.e. whenever the surplus process is above a certain barrier b , the excess is paid out as dividends immediately, and no dividends are paid out below this level b . In recent years, this problem was studied for general spectrally negative Lévy processes, and the most general conditions on such a process for which barrier-policies are optimal have recently been given in Loeffen & Renaud [10]. We refer to Schmidli [11] and Albrecher & Thonhauser [2] for an overview of mathematical tools and results in this area.

The implementation of the optimal pay-out policies that were identified for the above-mentioned continuous-time models of the surplus process need continuous observation of (and usually continuous intervention into) the surplus process, which can not be realized in practice. In this paper we therefore follow a somewhat different approach, namely to still consider a continuous-time model for the surplus process, as the latter is useful for many reasons, but to assume that observations (of possible ruin) and interventions (i.e. dividend pay-outs) are only possible at discrete points in time, and these time points are determined by a renewal process which is independent of the surplus process. This will enable a general treatment of the stochastic control problem to determine the optimal dividend pay-out scheme.

* The first author would like to acknowledge support from the Swiss National Science Foundation Project 200021-124635/1.

We will work with a general Lévy process for the underlying surplus process. Note that if one considers the value of the surplus process at the observation times only, this results again in a random walk, now with random discounting where in each period the random discount factor is also dependent on the size of the increment. Since this interpretation does not seem natural and, also, the available results for random discounting do not directly apply to our situation, we prefer to give a self-contained treatment in the present framework (see Remark 2.1 for details). We will show that under the above assumptions, a band-policy is optimal. We then show that for the case where the random observation times are determined by a homogeneous Poisson process and the surplus process is given by a Cramér-Lundberg risk process with exponential claims, this optimal policy collapses to a barrier-policy. We also discuss the diffusion model for the surplus process as a limiting case. Finally, we give an explicit example of a surplus process for which a band-policy with two bands is - according to numerical computations - optimal.

2. A DIVIDEND PAY-OUT MODEL WITH RANDOM INTERVENTION TIMES

We suppose that the surplus process (S_t) of an insurance company is given by a general (one-dimensional) Lévy process, i.e. the process (S_t) has independent and identically distributed increments and the paths are assumed to be right-continuous with left-hand limits (càdlàg). Important special cases are the pure diffusion setting

$$S_t = x + ct + \sigma W_t, \quad t \geq 0,$$

where $c > 0$ and (W_t) is a Brownian motion, and the classical Cramér-Lundberg risk model

$$S_t = x + ct - \sum_{i=1}^{N_t} U_i, \quad t \geq 0$$

where (N_t) is a Poisson process with intensity $\lambda > 0$ and the claim sizes U_1, U_2, \dots are independent and identically distributed positive random variables. The parameter c is here the premium rate. In general a Lévy process can be characterized by its Lévy triplet (c, σ^2, ν) , where ν is the Lévy measure.

At (random) discrete time points $0 = Z_0 < Z_1 < \dots$ we are allowed to pay out dividends. We assume that the time lengths $T_n := Z_n - Z_{n-1}, n = 1, 2, \dots$ between interventions form a sequence of i.i.d. random variables which is also independent of the stochastic process (S_t) . Thus it is enough to observe the process $(S(Z_n))$ which evolves in discrete time. All quantities are assumed to be defined on a common probability space $(\Omega, \mathcal{F}, \mathbb{P})$. In what follows we denote by

$$Y_n := S(Z_n) - S(Z_{n-1}), \quad n = 1, 2, \dots$$

the increments of the surplus process. The aim is now to find a dividend pay-out policy such that the expected discounted dividends until ruin are maximized. Note that ruin is defined as the event that the surplus process at an observation time point is negative, so we disregard what happens between the time points (Z_n) . Obviously the bivariate sequence (T_n, Y_n) is i.i.d.

In order to solve this problem we use the theory of Markov Decision Processes (for details see e.g. Bäuerle & Rieder [5]). More precisely we assume that \mathbb{R}_+ is the state space of the problem where the state x represents the current surplus. The action space is \mathbb{R}_+ where the action a represents the amount of money which is paid out as dividend. When the surplus is x we obtain the constraint that we have to restrict the dividend pay-out to the set $D(x) := [0, x]$. The one-stage reward of the problem is $r(x, a) =: a$. A dividend policy $\pi = (f_0, f_1, \dots)$ is simply a sequence of decision rules f_n , where a function $f_n : \mathbb{R}_+ \rightarrow \mathbb{R}_+$ is called decision rule when it

is measurable and $f(x) \in D(x)$ is satisfied. The controlled surplus process (X_n) is given by the transition

$$X_n := X_{n-1} - f_{n-1}(X_{n-1}) + Y_n, \quad n = 1, 2, \dots$$

When we denote by

$$\tau := \inf\{n \in \mathbb{N}_0 : X_n < 0\}$$

the ruin time point in discrete time and by $\delta > 0$ the discount rate, then the expected discounted dividends under pay-out policy $\pi = (f_0, f_1, \dots)$ are given by

$$V(x; \pi) := \mathbb{E}_x \left[\sum_{n=0}^{\tau-1} e^{-\delta Z_n} f_n(X_n) \right], \quad x \in \mathbb{R}_+.$$

The optimization problem then is

$$V(x) := \sup_{\pi} V(x; \pi), \quad x \in \mathbb{R}_+,$$

where the supremum is taken over all policies. In what follows we assume that (we let $T := T_1$ and $Y := Y_1$)

- (a) $\mathbb{P}(0 < T < \infty) = 1$,
- (b) $\mathbb{P}(Y < 0) > 0$,
- (c) $\mathbb{E}Y^+ < \infty$,
- (d) either $\sigma > 0$ (there is a Brownian part), $\nu(\mathbb{R}) = \infty$ (infinite activity) or (S_t) is compound Poisson and jump sizes have a density.

The first assumption is natural, the second and the third assumption make the problem non-trivial. The last assumption guarantees that the distribution of S_t has a density (see e.g. Cont & Tankov [6], Section 3.6), with the exception that in the compound Poisson case there is a point mass on $x + ct$, because $S_t = x + ct$ corresponds to the event that no claim occurs in the time interval $[0, t]$.

Finally note that if we denote by Q the joint distribution of T and Y , then the transition kernel for the Markov Decision Process is for a measurable function $v : \mathbb{R}_+ \rightarrow \mathbb{R}_+$, state x and action $a \in D(x)$ given by

$$\int_0^\infty \int_{a-x}^\infty e^{-\delta t} v(x - a + y) Q(dy, dt).$$

Here the integration limits of the inner integral ensure that dividends can only be paid until ruin or up to x .

Remark 2.1. It becomes clear from the preceding discussion that one could also interpret the model studied in this paper as a discrete time random walk model with random discounting, albeit with a very specific dependence between the random “discount rate” δT_n and the random walk increment Y_n in each period n (specified through the bivariate distribution Q for the i.i.d. pairs (T_n, Y_n) , $n \geq 1$). Whereas this dependence of the increment $Y_n = S(Z_n) - S(Z_{n-1})$ on $T_n = Z_n - Z_{n-1}$ is natural in our model, it may not be so intuitive in the random discounting framework. Furthermore, on the technical side, in contrast to the pure random walk model dealt with by Schmidli [11], we face here an uncountable state space and consequently a different transition operator. Finally, as we will later directly exploit our specific dependence structure represented by Q , we prefer to refrain from the random discounting interpretation in the sequel and instead give a self-contained treatment tailored to our random observations interpretation.

3. THE BELLMAN EQUATION AND FIRST PROPERTIES

In this section we will show some simple properties of the value function V and the validity of the Bellman equation which gives us a tool to solve the problem. In order to state the results let us introduce the following abbreviations where $x^+ := \max(0, x)$ is the positive part of x :

- (a) $\mathbb{E}[e^{-\delta T}] =: \beta$,
- (b) $\mathbb{E}[e^{-\delta T} Y^+] =: C$,
- (c) $\mathbb{E}[e^{-\delta T} 1_{[Y \geq 0]}] =: \beta_+$,

Note that $\beta_+ \leq \beta < 1$. Moreover we introduce the operator T_\circ which acts on the set $\mathbb{M} := \{v : \mathbb{R}_+ \rightarrow \mathbb{R}_+ \text{ measurable}\}$:

$$T_\circ v(x) := \sup_{a \in [0, x]} \left\{ \int_0^\infty \int_{a-x}^\infty e^{-\delta t} v(x - a + y) Q(dy, dt) \right\}.$$

A first observation gives us the following bounds on V and a convergence statement:

Lemma 3.1. *In the dividend pay-out problem the following holds:*

- a) *The value function is bounded by*

$$x + \frac{C}{1 - \beta_+} \leq V(x) \leq x + \frac{C}{1 - \beta}, \quad x \in \mathbb{R}_+.$$

- b) *For $b(x) := 1 + x$ it holds that:*

$$T_\circ^n b \leq \beta^n b + n\beta^{n-1}C, \quad n \in \mathbb{N}.$$

Proof. a) The upper bound is obtained when we replace the increments Y_n by Y_n^+ . Obviously the value of the problem increases and since $Y_n^+ \geq 0$ one can never get ruined and it is optimal to pay-out immediately. Hence

$$\begin{aligned} V(x) &\leq x + \mathbb{E} \left[\sum_{n=1}^\infty e^{-\delta(T_1 + \dots + T_n)} Y_n^+ \right] \\ &= x + C \sum_{n=0}^\infty \beta^n = x + \frac{C}{1 - \beta}. \end{aligned}$$

The lower bound is obtained by considering the special policy which pays out the complete surplus. Here we obtain:

$$\begin{aligned} V(x) &\geq x + \mathbb{E} \left[e^{-\delta T_1} Y_1^+ + \sum_{n=2}^\infty e^{-\delta(T_1 + \dots + T_n)} Y_n^+ 1_{[Y_1 \geq 0, \dots, Y_{n-1} \geq 0]} \right] \\ &= x + C \sum_{n=0}^\infty \beta_+^n = x + \frac{C}{1 - \beta_+}. \end{aligned}$$

- b) We show the statement for $n = 1$, the rest follows easily by iteration.

$$\begin{aligned} T_\circ b(x) &= \sup_{a \in [0, x]} \left\{ \int_0^\infty \int_{a-x}^\infty e^{-\delta t} (1 + x - a + y) Q(dy, dt) \right\} \leq \\ &\leq \int_0^\infty \int_{-\infty}^\infty e^{-\delta t} (1 + x) Q(dy, dt) + \int_0^\infty \int_0^\infty e^{-\delta t} y Q(dy, dt) \\ &= (1 + x)\beta + C. \end{aligned}$$

□

For $\mathbb{M}_b := \{v \in \mathbb{M} : v \leq cb \text{ for some } c > 0\}$, we obviously have $V \in \mathbb{M}_b$. Next we can show the validity of the Bellman equation

$$V(x) = \sup_{a \in [0, x]} \left\{ a + \int_0^\infty \int_{a-x}^\infty e^{-\delta t} V(x - a + y) Q(dy, dt) \right\}, \quad x \in \mathbb{R}_+, \quad (3.1)$$

which helps solving the dividend pay-out problem. In order to ease notation, it is common to introduce the following operators: For a decision rule f and a function $v \in \mathbb{M}_b$ let us denote

$$\begin{aligned} T_f v(x) &:= f(x) + \int_0^\infty \int_{f(x)-x}^\infty e^{-\delta t} v(x - f(x) + y) Q(dy, dt), \\ T v(x) &:= \sup_f T_f v(x). \end{aligned}$$

Hence the Bellman equation can also be written as $TV = V$. A decision rule f with the property $T_f v = Tv$ is called *maximizer* of v . The fact that $T_\circ^n b \rightarrow 0$ for $n \rightarrow \infty$ is an important condition which implies that maximizers of the Bellman equation yield an optimal stationary policy (i.e. the maximizer only depends on the state of the surplus, but yields the optimal policy also among path-dependent strategies).

Theorem 3.2. *The value function V of the dividend pay-out problem satisfies the Bellman equation:*

$$V(x) = \sup_{a \in [0, x]} \left\{ a + \int_0^\infty \int_{a-x}^\infty e^{-\delta t} V(x - a + y) Q(dy, dt) \right\}, \quad x \in \mathbb{R}_+.$$

Moreover, maximizers of V exist and every maximizer f^* of V defines an optimal stationary policy (f^*, f^*, \dots) .

Proof. The proof follows essentially from the analogous statement to Theorem 7.2.1 in Bäuerle & Rieder [5] for the continuous case. Note that the convergence condition $\lim_{n \rightarrow \infty} T_\circ^n b = 0$ is satisfied. Moreover we have that $D(x) = [0, x]$ is compact, the set-valued mapping $x \rightarrow D(x)$ is continuous, the mapping $(x, a) \mapsto r(x, a) = a$ is continuous and finally for every $v \in \mathbb{M}_b$ which is continuous the mapping

$$(x, a) \mapsto \int_0^\infty \int_{a-x}^\infty e^{-\delta t} v(x - a + y) Q(dy, dt)$$

is again continuous. Note that the possible discontinuity of Q in the compound Poisson case is away from the boundary and due to our integrability assumption we can apply dominated convergence. \square

In what follows, we will use the abbreviation

$$G(x) := \int_0^\infty \int_{-x}^\infty e^{-\delta t} V(x + y) Q(dy, dt), \quad x \in \mathbb{R}_+$$

for the sake of readability. Then we can write the Bellman equation as

$$V(x) = \sup_{a \in [0, x]} \{a + G(x - a)\}, \quad x \in \mathbb{R}_+.$$

The decision rule f^* will always be the largest maximizer of V . From Remark 2.4.9 in Bäuerle & Rieder [5] it follows that f^* is upper semicontinuous and from Proposition 2.4.8 in Bäuerle & Rieder [5] we know that f^* is continuous if it is unique. The following two lemmata establish some basic properties of the value function in our model.

Lemma 3.3. *The value function has the following properties:*

a) V is increasing and

$$V(x) - V(y) \geq x - y, \quad x \geq y \geq 0.$$

b) It holds for $x \geq 0$ that $f^*(x - f^*(x)) = 0$ and

$$V(x) - f^*(x) = V(x - f^*(x)).$$

Proof. a) The fact that $V(x)$ is increasing is obvious. Now let $0 \leq y \leq x$. We obtain

$$\begin{aligned} V(x) &= \sup_{a \in [0, x]} \{a + G(x - a)\} \geq \\ &\geq \sup_{a \in [0, y]} \{x - y + a + G(y - a)\} = x - y + V(y). \end{aligned}$$

b) From the Bellman equation we obtain that $V(x) = f^*(x) + G(x - f^*(x))$ and $V(x - f^*(x)) \geq G(x - f^*(x))$. Thus it follows with part a) that

$$V(x) - f^*(x) \leq V(x - f^*(x)) \leq V(x) - f^*(x).$$

Hence we get $V(x) - f^*(x) = V(x - f^*(x))$ which implies $V(x - f^*(x)) = G(x - f^*(x))$. Hence we know that $a^* = 0$ is optimal in state $x - f^*(x)$. We have to show that this is the maximal solution. Now suppose the largest maximizer satisfies $f^*(x - f^*(x)) > 0$. By definition we have

$$V(x - f^*(x)) = f^*(x - f^*(x)) + G(x - f^*(x) - f^*(x - f^*(x))).$$

By our assumptions it is feasible to pay out the amount $f^*(x) + f^*(x - f^*(x))$ in state x . When we do this we obtain with the previous equation

$$\begin{aligned} f^*(x) + f^*(x - f^*(x)) + G(x - f^*(x) - f^*(x - f^*(x))) \\ = f^*(x) + V(x - f^*(x)) = V(x) = f^*(x) + G(x - f^*(x)). \end{aligned}$$

But this implies that $f^*(x) + f^*(x - f^*(x)) > f^*(x)$ also maximizes the Bellman equation which is a contradiction to the maximal property of $f^*(x)$ and the statement follows. \square

Next we can show that there exists a finite value ξ for the optimal dividend pay-out policy, beyond which all surplus is paid out. It is easy to see that this property implies that ruin occurs with probability one.

Lemma 3.4. *Let $\xi := \sup\{x \in \mathbb{R}_+ \mid f^*(x) = 0\}$. Then $\xi < \infty$ and*

$$f^*(x) = x - \xi \quad \text{for all } x \geq \xi.$$

Proof. For $x \geq 0$ with $f^*(x) = 0$ we obtain with the upper bound in Lemma 3.1:

$$\begin{aligned} V(x) &= G(x) = \mathbb{E} \left[e^{-\delta T} V(x + Y) 1_{[Y \geq -x]} \right] \\ &\leq \mathbb{E} \left[e^{-\delta T} \left((x + Y) + \frac{C}{1 - \beta} \right) 1_{[Y \geq -x]} \right] \\ &\leq \beta x + C + \frac{C}{1 - \beta} \beta = \beta x + \frac{C}{1 - \beta}. \end{aligned}$$

On the other hand we have from Lemma 3.1 the lower bound:

$$V(x) \geq x + \frac{C}{1 - \beta_+}.$$

These bounds imply that

$$x \leq \frac{C(\beta - \beta_+)}{(1 - \beta^2)(1 - \beta_+)}.$$

Hence ξ is finite. Now suppose $f^*(\xi) > 0$. The definition of ξ implies that there exists an $\varepsilon \in (0, f^*(\xi))$ such that $f^*(\xi - \varepsilon) = 0$. Since $f^*(\xi)$ is a maximizer it holds

$$f^*(\xi) + G(\xi - f^*(\xi)) \geq \varepsilon + G(\xi - \varepsilon).$$

Since $f^*(\xi) - \varepsilon$ is a feasible pay-out in state $\xi - \varepsilon$ we obtain with the previous inequality

$$f^*(\xi) - \varepsilon + G(\xi - \varepsilon - f^*(\xi) + \varepsilon) = f^*(\xi) - \varepsilon + G(\xi - f^*(\xi)) \geq G(\xi - \varepsilon)$$

which, since 0 is an optimal pay-out in state $\xi - \varepsilon$, implies that $f^*(\xi - \varepsilon) \geq f^*(\xi) - \varepsilon > 0$ which is a contradiction. Altogether it follows that $f^*(\xi) = 0$.

Now let $x \geq \xi$. From Lemma 3.3 we know that $f^*(x - f^*(x)) = 0$ which implies by the definition of ξ that $f^*(x) \geq x - \xi$. Since $x - f^*(x) \leq \xi \leq x$ it is admissible to pay out $f^*(x) - (x - \xi)$ in ξ . Hence

$$V(\xi) \geq f^*(x) - (x - \xi) + G(x - f^*(x)) = V(x) - (x - \xi) \geq V(\xi) \quad (3.2)$$

where the last inequality follows from Lemma 3.3. We see now that equality must hold in (3.2) and this implies that $0 = f^*(\xi) \geq f^*(x) - (x - \xi)$. Together with the first inequality we obtain $f^*(x) = x - \xi$ which concludes the proof. \square

4. OPTIMALITY OF A BAND-POLICY

In this section we will show that an optimal dividend pay-out policy is given by a so-called *band-policy*.

Definition 4.1. a) A stationary policy f^∞ is called a *band-policy*, if there exists a partition of \mathbb{R}^+ of the form $A \cup B = \mathbb{R}^+$ with

$$f(x) = \begin{cases} 0, & \text{if } x \in B, \\ x - z \text{ where } z = \sup\{y \mid y \in B \wedge 0 \leq y < x\}, & \text{if } x \in A. \end{cases}$$

b) A stationary policy f^∞ is called a *barrier-policy* if there exists a number $c \geq 0$ such that

$$f(x) = \begin{cases} 0, & \text{if } x \leq c \\ x - c, & \text{if } x > c. \end{cases}$$

Remark 4.2. Note that from Lemma 3.4 we have $(\xi, \infty) \subset A$. If the number of connected components of the set $A \cap [0, \xi]$ is finite (which is not clear a priori), one can define a *band-policy* f^∞ in a simpler way through numbers $0 \leq c_0 < d_1 \leq c_1 < d_2 \leq \dots < \xi$ with

$$f(x) = \begin{cases} 0, & \text{if } x \leq c_0, \\ x - c_k, & \text{if } c_k < x < d_{k+1}, \\ 0, & \text{if } d_k \leq x \leq c_k, \\ x - \xi, & \text{if } x \geq \xi. \end{cases}$$

Finally, a barrier-policy is a special band-policy with $B = [0, c]$ and $A = (c, \infty)$.

Theorem 4.3. *The optimal policy (f^*, f^*, \dots) is a band-policy.*

Proof. We only have to consider the interval $[0, \xi]$ since f^* is known on $[\xi, \infty)$ according to Lemma 3.4. Next observe that for $0 \leq y < x \leq \xi$ we have

$$V(x) = \sup_{a \in [0, x]} \{a + G(x - a)\} \geq x - y + \sup_{a \in [0, y]} \{a + G(y - a)\}.$$

In particular, if $f^*(x) > x - y$ then $f^*(x) = f^*(y) + x - y$. This can be used to construct the bands as follows: Let $f^*(x') := \sup_{0 \leq x \leq \xi} f^*(x)$. The maximal value is attained since f^* is upper semicontinuous. If $f^*(x') = 0$, a barrier-policy is optimal and we are done. Now suppose that $f^*(x') > 0$. From our previous considerations we know that on $[x' - f^*(x'), x']$ it holds that $f^*(x) = x - x' + f^*(x')$. Then we look for the next highest value on the remaining set $[0, \xi] \setminus [x' - f^*(x'), x']$. This procedure is carried on until all bands are constructed. \square

Corollary 4.4. *When the maximizer f^* is unique, then the optimal policy is a barrier-policy.*

Proof. When the maximizer f^* is unique we know from Proposition 2.4.8 in Bäuerle & Rieder [5] that f^* is continuous. A band-policy (f^*, f^*, \dots) with continuous f^* however is a barrier-policy. \square

Corollary 4.4 shows that there is an intimate relation between the existence of a barrier-policy and the uniqueness of the maximizer. Moreover, if the maximizer is not unique, still a barrier-policy may be among the optimal policies.

5. THE COMPOUND POISSON CASE WITH EXPONENTIAL CLAIMS - OPTIMALITY OF A BARRIER-POLICY

In this section we suppose that the surplus process is a compound Poisson process with claim arrival process (N_t) having intensity $\lambda > 0$ and exponentially distributed claim sizes U_i with parameter $\nu > 0$. The premium rate is again denoted by c . Thus we obtain

$$S_t = x + ct - \sum_{i=1}^{N_t} U_i, \quad t \geq 0.$$

The inter-observation times are also assumed to be exponentially distributed with parameter $\gamma > 0$ (i.e. the observations are determined by a homogeneous Poisson process with intensity γ). For a fixed barrier-policy (f^b, f^b, \dots) with barrier b , i.e.

$$f^b(x) = \begin{cases} 0, & 0 \leq x \leq b, \\ x - b, & x > b, \end{cases}$$

the expected discounted dividends have been computed in Albrecher, Cheung & Thonhauser [1] to be

$$V(x; b) = \begin{cases} V_M(x; b), & 0 \leq x \leq b, \\ x - b + V_M(b; b), & x > b, \end{cases}$$

where

$$V_M(x; b) = \frac{(R_\gamma + \rho_0)e^{\rho_0 x} - (R_\gamma - R_0)e^{-R_0 x}}{\frac{R_\gamma + \rho_0}{1 - \rho_0/\rho_\gamma} \rho_0 e^{\rho_0 b} + \frac{R_\gamma - R_0}{1 + R_0/\rho_\gamma} R_0 e^{-R_0 b}}$$

and $-R_\gamma < 0$ and $\rho_\gamma > 0$ ($-R_0 < 0$, $\rho_0 > 0$ for $\gamma = 0$) are roots of the quadratic equation

$$z^2 + \left(\nu - \frac{\lambda + \gamma + \delta}{c} \right) z - \frac{(\gamma + \delta)\nu}{c} = 0,$$

which is the extension of the Lundberg fundamental equation for this case. In that derivation, using the usual renewal argument, one formulates an interacting system of integro-differential equations for $V(x; b)$ (representing the three layers $x < 0$, $0 \leq x \leq b$ and $x > b$). For exponential claims this can be transformed into a system of second-order ordinary differential equations with constant coefficients which can be solved explicitly, giving the above solution V_M for the middle layer $0 \leq x \leq b$ (see [1] for details).

In what follows we suppose that b is already the barrier with the maximal value. This maximal value is given by

$$b = \max \left\{ 0, \frac{1}{\rho_0 + R_0} \log \frac{(R_\gamma - R_0)(\rho_\gamma - \rho_0)R_0^2}{(R_\gamma + \rho_0)(\rho_\gamma + R_0)\rho_0^2} \right\} \quad (5.1)$$

according to Example 5.1 in Albrecher, Cheung & Thonhauser [1].

Theorem 5.1. *The barrier-policy (f^b, f^b, \dots) is optimal in the compound Poisson case with exponential claims.*

Proof. In order to show that the barrier-policy is optimal we have to show that $TV(x; b) = T_{f^b}V(x; b)$. The statement follows then from Howard's policy improvement algorithm since (f^b, f^b, \dots) cannot be improved in this case (see Theorem 7.5.1 in Bäuerle & Rieder [5]). When we consider

$$TV(x; b) = \sup_{a \in [0, x]} \left\{ a + \int_0^\infty \int_{a-x}^\infty e^{-\delta t} V(x - a + y; b) Q(dy, dt) \right\},$$

it is crucial to note that the expression

$$\tilde{V}(x; b) := \int_0^\infty \int_{-x}^\infty e^{-\delta t} V(x + y; b) Q(dy, dt)$$

equals exactly the expected discounted dividends when we are not allowed to pay out a dividend at time 0 and then follow the barrier-policy for the next observation time points. Thus we can write

$$TV(x; b) = \sup_{a \in [0, x]} \left\{ a + \tilde{V}(x - a; b) \right\}.$$

The quantity \tilde{V} is the value of a barrier policy if there is no observation at $t = 0$ (which for $0 \leq x \leq b$ coincides with V_M , whereas for the upper layer $x > b$ it differs from V , as the excess over b is not paid out until the first observation). \tilde{V} has been computed in Albrecher, Cheung & Thonhauser [1] to be

$$\tilde{V}(x; b) = \begin{cases} V_M(x; b), & 0 \leq x \leq b \\ V_U(x; b), & x > b \end{cases}$$

where

$$V_U(x; b) = \frac{\gamma(x - b)}{\gamma + \delta} + \frac{1}{R_\gamma} (e^{-R_\gamma(x-b)} - 1) \left(\frac{\gamma}{\gamma + \delta} - 1 \right) + V_M(b; b).$$

Note that we have used here that the optimal b has the property $\left. \frac{d}{dx} V(x; b) \right|_{x=b} = 1$ (see Section 5 of Albrecher, Cheung & Thonhauser [1]). It can now be shown that

- (i) $\tilde{V}(x; b) < V_M(b; b) + x - b$ for $x > b$,
- (ii) $V(x; b) - V(y; b) > x - y$ for $0 \leq y < x \leq b$.

The first inequality follows when we plug in the formula for $\tilde{V}(x; b)$. Rearranging the terms gives

$$\frac{1}{R_\gamma} \left(1 - e^{-R_\gamma(x-b)} \right) < x - b.$$

Inspecting the derivative of the left-hand side we see that this is true for $x > b$. The second inequality is satisfied if $\frac{d}{dx} V(x; b) > 1$ for $x \in (0, b)$. We assume here that $b > 0$, otherwise the statement is obvious. Since at $x = b$ this derivative is equal to 1, the statement is shown if $\frac{d^2}{dx^2} V(x; b) < 0$ for $x \in (0, b)$. Computing the second derivative we see that it is increasing in x and hence it is enough to check that $\left. \frac{d^2}{dx^2} V(x; b) \right|_{x=b} < 0$. This is satisfied if and only if

$$(R_\gamma + \rho_0)\rho_0^2 e^{\rho_0 b} < R_0^2 (R_\gamma - R_0) e^{-R_0 b}.$$

Rearranging terms this is equivalent to

$$b < \frac{1}{\rho_0 + R_0} \log \frac{(R_\gamma - R_0)R_0^2}{(R_\gamma + \rho_0)\rho_0^2}.$$

But this is true since we know from Section 5 in Albrecher, Cheung & Thonhauser [1] that the optimal b is given by

$$b = \frac{1}{\rho_0 + R_0} \log \frac{(R_\gamma - R_0)R_0^2(\rho_\gamma - \rho_0)}{(R_\gamma + \rho_0)\rho_0^2(\rho_\gamma + R_0)}$$

and $(\rho_\gamma - \rho_0)/(\rho_\gamma + R_0) \in (0, 1)$.

Properties (i) and (ii) yield now the desired result:

First suppose that $0 \leq x \leq b$. In this case we have

$$\tilde{V}(x; b) = V(x; b) > x - (x - a) + V(x - a; b) = a + V(x - a; b)$$

for $a \in (0, x]$ by virtue of (ii). Hence $a^* = 0$ maximizes the expression.

Next suppose that $x > b$. For an $a > x - b$ we obtain

$$x - b + V(b; b) > a + V(x - a; b)$$

again by (ii). For $a < x - b$ we obtain

$$x - b + V_M(b; b) > a + \tilde{V}(x - a; b)$$

by (i). Hence $a^* = x - b$ maximizes the expression.

Altogether we have shown that f^b is again a maximizer of $V(x; b)$ which yields the statement. \square

6. CONVERGENCE TO A DIFFUSION MODEL

Consider now a sequence of the exponential models studied in the previous section. More precisely, let us assume that in the n -th model, the Poisson process (N_t^n) has intensity $\lambda_n := \lambda n$, the claim sizes U_i^n are exponentially distributed with parameter $\nu_n := \nu\sqrt{n}$ and the premium rate is $c_n := \frac{\lambda}{\nu}\sqrt{n}(\rho_n + 1)$ with $\lim_{n \rightarrow \infty} \sqrt{n}\rho_n = \kappa$. The parameter γ of the random observation time and the discount factor δ are kept fixed. Then it is well known (see e.g. Grandell [9, Sec.1.2]) that the corresponding compound Poisson process can be written as

$$\begin{aligned} S_t^n &:= x + c_n t - \sum_{i=1}^{N_t^n} U_i^n \\ &\stackrel{d}{=} x + \frac{\lambda}{\nu}\sqrt{n}(\rho_n + 1)t - \sum_{i=1}^{N_{nt}} \frac{U_i}{\sqrt{n}} \\ &= x + \frac{\lambda}{\nu}\sqrt{n}\rho_n t - \sqrt{2\lambda/\nu^2} \left(\frac{\bar{S}(nt) - (\lambda/\nu)nt}{\sqrt{2\lambda/\nu^2}\sqrt{n}} \right) \end{aligned}$$

where $\bar{S}(t) := \sum_{i=1}^{N_t} U_i$. From this representation it follows that (S_t^n) converges for $n \rightarrow \infty$ weakly to a diffusion. More precisely we have

$$(S_t^n) \Rightarrow \left(x + \frac{\lambda}{\nu}\kappa t + \sqrt{2\lambda/\nu^2} W_t \right) \quad (6.1)$$

where \Rightarrow denotes weak convergence on the space of càdlàg functions and (W_t) is Brownian motion. Obviously the limiting model is again in the general Lévy class that we considered in the beginning. Since we know already from the previous section that for every exponential model a barrier-policy is optimal, one can show - by taking limits - that the same is true for

a diffusion model (in principle one could of course do an analysis similar to Section 5 directly for the diffusion model; it is however instructive to study the limiting behavior, as it is not a priori clear that also the optimal strategy converges to the one of the limiting diffusion, see also Bäuerle [4]). In order to rigorously show this statement, we first investigate the fundamental equation

$$z^2 + \left(\nu_n - \frac{\lambda_n + \gamma + \delta}{c_n} \right) z - \frac{(\gamma + \delta)\nu_n}{c_n} = 0. \quad (6.2)$$

Lemma 6.1. *The roots $-R_\gamma^n < 0$, $\rho_\gamma^n > 0$ of equation (6.2) converge for $n \rightarrow \infty$ to finite values and the optimal barriers b^n also converge to a finite value b .*

Proof. Looking at the coefficients of equation (6.2) we see that

$$\begin{aligned} \lim_{n \rightarrow \infty} \left(\nu_n - \frac{\lambda_n + \gamma + \delta}{c_n} \right) &= \lim_{n \rightarrow \infty} \frac{\lambda \sqrt{n} \rho_n - (\gamma + \delta) / \sqrt{n}}{\rho_n \lambda / \nu + \lambda / \nu} = \kappa \nu \\ \lim_{n \rightarrow \infty} \frac{(\gamma + \delta)\nu_n}{c_n} &= \lim_{n \rightarrow \infty} \frac{(\gamma + \delta)\nu^2}{\lambda(\rho_n + 1)} = \frac{(\gamma + \delta)\nu^2}{\lambda}. \end{aligned}$$

Hence the roots of equation (6.2) converge to the roots of

$$x^2 + \kappa \nu x - \frac{(\gamma + \delta)\nu^2}{\lambda} = 0.$$

Inspecting the formula (5.1) for the optimal barriers b^n we immediately see that $\lim_{n \rightarrow \infty} b^n = b$ is well-defined. Note that the expression in the logarithm cannot be zero. \square

With our choice of parameters, we obtain

Lemma 6.2.

$$\lim_{n \rightarrow \infty} \mathbb{E}[e^{-\delta T}(Y^n)^+] = \lim_{n \rightarrow \infty} C^n = \mathbb{E}[e^{-\delta T}Y^+] =: C. \quad (6.3)$$

Proof. By our assumptions we know that $Y^n \Rightarrow Y$ and hence with the continuous mapping theorem we obtain $e^{-\delta T}(Y^n)^+ \Rightarrow e^{-\delta T}(Y)^+$. Thus, the statement follows if we can show that the sequence $(e^{-\delta T}(Y^n)^+)$ is uniformly integrable. But this follows since the sequence is L^2 -bounded:

$$\begin{aligned} \sup_n \mathbb{E} \left[e^{-2\delta T} ((Y^n)^+)^2 \right] &\leq \sup_n \mathbb{E} \left[e^{-2\delta T} (Y^n)^2 \right] \\ &= \sup_n \int_0^\infty e^{-2\delta t} \int_{\mathbb{R}} y^2 Q_n(dy|t) g(t) dt, \end{aligned}$$

where $Q_n(\cdot|t)$ is the distribution of Y^n given $T = t$ and g is the density of T . Let us consider the inner integral:

$$\begin{aligned} \int_{\mathbb{R}} y^2 Q_n(dy|t) &= \mathbb{E} \left[\left(c_n t - \sum_{i=1}^{N_t^n} U_i^n \right)^2 \right] \\ &= (c_n t)^2 - 2c_n t^2 \frac{\lambda}{\nu} \sqrt{n} + \mathbb{E} \left[\left(\sum_{i=1}^{N_t^n} U_i^n \right)^2 \right] \\ &= (c_n t)^2 - 2c_n t^2 \frac{\lambda}{\nu} \sqrt{n} + 2t \frac{\lambda}{\nu^2} + t^2 n \frac{\lambda^2}{\nu^2} \\ &= t^2 \frac{\lambda^2}{\nu^2} n \rho_n^2 + 2t \frac{\lambda}{\nu^2} \leq t^2 \frac{\lambda^2}{\nu^2} \bar{\kappa}^2 + 2t \frac{\lambda}{\nu^2}, \end{aligned}$$

where $\bar{\kappa} := \sup_n \sqrt{n} \rho_n$ which is finite since $\lim_{n \rightarrow \infty} \sqrt{n} \rho_n = \kappa$. Hence we obtain

$$\sup_n \int_0^\infty e^{-2\delta t} \int_{\mathbb{R}} y^2 Q_n(dy|t) g(t) dt \leq \int_0^\infty e^{-2\delta t} \left(t^2 \frac{\lambda^2}{\nu^2} \bar{\kappa}^2 + 2t \frac{\lambda}{\nu^2} \right) g(t) dt$$

which is finite since the expression in front of g is bounded. \square

Now for fixed $n \in \mathbb{N}$ the value function under the optimal barrier b^n is given by

$$V^n(x; b^n) = \begin{cases} V_M^n(x; b^n), & 0 \leq x \leq b^n \\ x - b^n + V_M^n(b^n; b^n), & x > b^n \end{cases}$$

where

$$V_M^n(x; b^n) = \frac{(R_\gamma^n + \rho_0^n) e^{\rho_0^n x} - (R_\gamma^n - R_0^n) e^{-R_0^n x}}{\frac{R_\gamma^n + \rho_0^n}{1 - \rho_0^n / \rho_\gamma^n} \rho_0^n e^{\rho_0^n b^n} + \frac{R_\gamma^n - R_0^n}{1 + R_0^n / \rho_\gamma^n} R_0^n e^{-R_0^n b^n}}.$$

Theorem 6.3. *It holds that the limit $\lim_{n \rightarrow \infty} V^n(x; b^n) =: V(x; b)$ exists, the convergence is uniform on \mathbb{R}_+ and the limit $V(x; b)$ equals the expected discounted dividends in the diffusion model given by (6.1) under the barrier-policy (f^b, f^b, \dots) .*

Proof. The pointwise convergence of $V^n(x; b^n)$ is obvious by its representation for $x \neq b$. For $x = b$ note that due to the continuity of $V(x; b)$ we have convergence of sequences from the left and from the right.

For the uniform convergence it is enough to show uniform convergence on the compact interval $I := [0, \max_n b^n]$ since the functions are linearly extended with slope one. However, uniform convergence can be seen directly by noting that in particular

$$\lim_{n \rightarrow \infty} \sup_{x \in I} \|e^{\rho_0^n x} - e^{\rho_0 x}\| \leq \max_k b^k e^{\max_k b^k \max_k \rho_0^k} \lim_{n \rightarrow \infty} \|\rho_0^n - \rho_0\| = 0.$$

From the exact formulas of the value functions it is easy to see that we obtain the same limit when we fix the barrier b , i.e. $\lim_{n \rightarrow \infty} V^n(x; b) = V(x; b)$.

Finally for the interpretation of the limit recall that

$$V^n(x; b) := \mathbb{E}_x \left[\sum_{k=0}^{\infty} e^{-\delta Z_k} f^b(X_k^n) 1_{[X_1^n \geq 0, \dots, X_{k-1}^n \geq 0]} \right]$$

where

$$X_k^n := X_{k-1}^n - f^b(X_{k-1}^n) + Y_k^n, \quad k = 1, 2, \dots$$

Thus X_k^n is a continuous function of the random variables (Y_1^n, \dots, Y_k^n) . By the choice of parameters we know that $(Y_1^n, \dots, Y_k^n) \Rightarrow (Y_1, \dots, Y_k)$ where Y_1, Y_2, \dots are the increments of the diffusion limit. From the continuous mapping theorem it follows for $n \rightarrow \infty$ that

$$e^{-\delta Z_k} f^b(X_k^n) 1_{[X_1^n \geq 0, \dots, X_{k-1}^n \geq 0]} \Rightarrow e^{-\delta Z_k} f^b(X_k) 1_{[X_1 \geq 0, \dots, X_{k-1} \geq 0]} \quad (6.4)$$

since $\mathbb{P}(X_1 = 0 \vee \dots \vee X_{k-1} = 0) = 0$, i.e. the discontinuity points in the indicator appear with zero probability. From (6.4) it follows with the Skorokhod Theorem that we can define a common probability space such that for $n \rightarrow \infty$

$$e^{-\delta Z_k} f^b(X_k^n) 1_{[X_1^n \geq 0, \dots, X_{k-1}^n \geq 0]} \rightarrow e^{-\delta Z_k} f^b(X_k) 1_{[X_1 \geq 0, \dots, X_{k-1} \geq 0]} \quad \text{a.s.}$$

It remains now to show that when considering the expression $\lim_{n \rightarrow \infty} V^n(x; b)$ we can interchange the limit and the expectation. Indeed we can use dominated convergence because

$$\sum_{k=0}^{\infty} e^{-\delta Z_k} f^b(X_k^n) 1_{[X_1^n \geq 0, \dots, X_{k-1}^n \geq 0]} \leq x + \sum_{k=1}^{\infty} e^{-\delta Z_k} (Y_k^n)^+ =: \bar{U}^n$$

and from (6.3) we obtain

$$\lim_{n \rightarrow \infty} \mathbb{E}_x \bar{U}^n = \lim_{n \rightarrow \infty} \left(x + \frac{C^n}{1 - \beta} \right) = x + \frac{C}{1 - \beta} = \mathbb{E}_x \left[\sum_{k=1}^{\infty} e^{-\delta Z_k} Y_k^+ \right].$$

Altogether we get

$$\lim_{n \rightarrow \infty} V^n(x; b) = \mathbb{E}_x \left[\sum_{k=0}^{\infty} e^{-\delta Z_k} f^b(X_k) 1_{[X_1 \geq 0, \dots, X_{k-1} \geq 0]} \right].$$

Thus the limit $V(x; b)$ indeed coincides with the expected discounted dividends in the limiting diffusion model under the barrier-policy. \square

Hence we finally obtain the main result of this section:

Theorem 6.4. *The barrier-policy (f^b, f^b, \dots) with $b := \lim_{n \rightarrow \infty} b_n$ is an optimal policy in the limiting diffusion model.*

Proof. In order to show this statement we consider for $n \in \mathbb{N}$:

$$\tilde{V}^n(x; b^n) := \int_0^{\infty} \int_{-x}^{\infty} e^{-\delta t} V^n(x + y; b^n) Q^n(dy, dt)$$

where Q^n is the joint distribution of (T, Y^n) . Using the explicit formulas for V^n and \tilde{V}^n we see that

$$\begin{aligned} \lim_{n \rightarrow \infty} \tilde{V}^n(x; b^n) &= \lim_{n \rightarrow \infty} \int_0^{\infty} \int_{-x}^{\infty} e^{-\delta t} V^n(x + y; b^n) Q^n(dy, dt) = \\ &= \int_0^{\infty} \int_{-x}^{\infty} e^{-\delta t} V(x + y; b) Q(dy, dt) =: \tilde{V}(x; b). \end{aligned}$$

Moreover, for fixed $x \in \mathbb{R}_+$ it can be shown that the convergence $\lim_{n \rightarrow \infty} \tilde{V}^n(x - a; b^n) = \tilde{V}(x - a; b)$ is uniform for $a \in [0, x]$. Thus we obtain with Lemma A.1.5 in Bäuerle & Rieder [5]

$$V(x; b) = \lim_{n \rightarrow \infty} V^n(x; b^n) = \lim_{n \rightarrow \infty} \sup_{a \in [0, x]} \left\{ a + \tilde{V}^n(x - a; b^n) \right\} = \sup_{a \in [0, x]} \left\{ a + \tilde{V}(x - a; b) \right\}.$$

Moreover it follows from the same lemma that f^b is a maximizer of the limiting fixed point equation, hence (f^b, f^b, \dots) is an optimal policy. \square

Figures 1 and 2 show $V^n(x; b^n)$ and the optimal barrier heights b^n for the parameters $\nu = 3$, $\lambda = 15$, $\gamma = 10$, $\delta = 0.05$. In both figures the choice $n = 1$ corresponds to the dotted line, $n = 10$ to the dotted-dashed line, $n = 50$ to the dashed line and $n = 1000$ to the solid line.

7. EXAMPLE WITH A BAND

Consider the example of a compound Poisson risk model with $T_n \sim \text{Exp}(\gamma)$ as in Section 5, but now with Erlang(2, ν)-distributed claims U_i . Concretely, choose $c = 21.4$, $\lambda = 10$, $\nu = 1$, $\delta = 0.1$ and $\gamma = 200$. Note that for $\gamma = \infty$ (i.e. continuous observation), this example was shown by Azcue & Muler[3] to admit no optimal barrier policy. We are now interested in whether a barrier strategy is optimal for the chosen finite value of γ .

Following the procedure of Albrecher, Cheung & Thonhauser[1, Sec.2] (also briefly sketched in Section 5 of this paper), one can calculate $\tilde{V}(x; b)$ and $V(x; b)$ (i.e. the expected discounted dividends without and with observation at time zero, respectively) for a barrier-policy with arbitrary barrier $b \geq 0$ and Erlang(2, ν) distributed claims.

For checking optimality within the set of all admissible dividend policies, we need to examine if

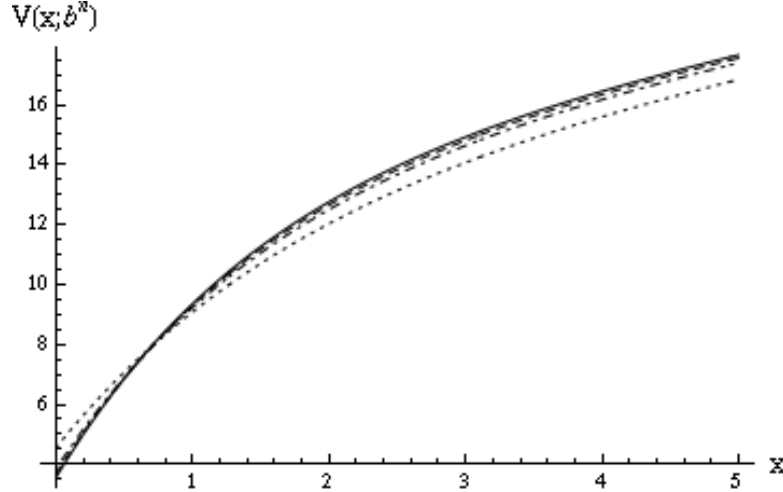
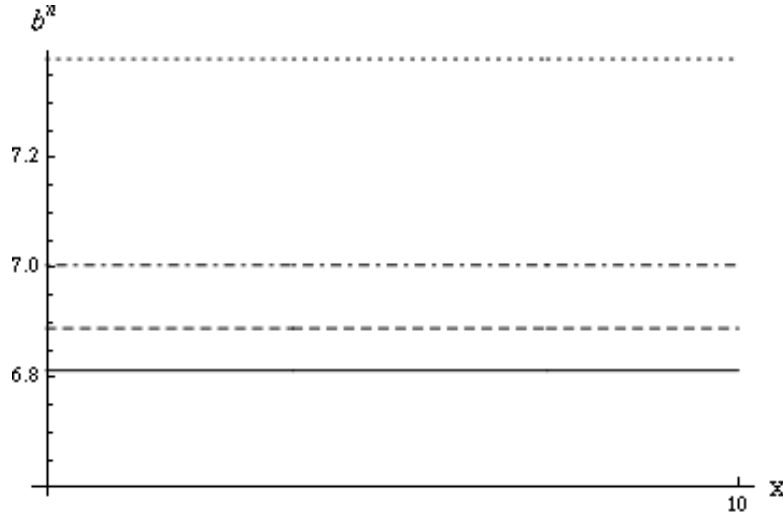
FIG. 1. $V(x; b^n)$ for $n = 1, 10, 50, 1000$ FIG. 2. b^n for $n = 1, 10, 50, 1000$

$V(x; b^*) = \sup_{a \in [0, x]} \{a + \tilde{V}(x - a; b^*)\}$ is fulfilled for the maximizing barrier height b^* (i.e. the optimal policy within the set of barrier-type policies). In particular, the associated intervention rule given by $f^{b^*}(x) = (x - b^*)I_{\{x > b^*\}}$ needs to be a maximizer of the right-hand side of the Bellman equation for all $x \in \mathbb{R}_+$.

When determining the optimal barrier level b^* among all possible barrier levels for the present model parameters, it turns out that for $0 \leq x \leq 1.5293$ one obtains the level $b^* = 0$, whereas for $x > 1.5293$ a barrier $b^* = 10.1389$ is preferable. This already shows that a barrier type policy can not be optimal for this set of parameters, since neither f^0 nor $f^{10.1389}$ yield a maximizer in the Bellman equation.

In addition, Figures 3 and 4 contain plots of $a + \tilde{V}(x - a; b^*) - V(x; b^*)$ and $a + \tilde{V}(x - a; 0) - V(x; 0)$ (the black areas indicate the level 0), which are the relevant quantities in the proof of Theorem 5.1 for proving the fixed point property of the value function. One observes that $V(x; b^*)$ as

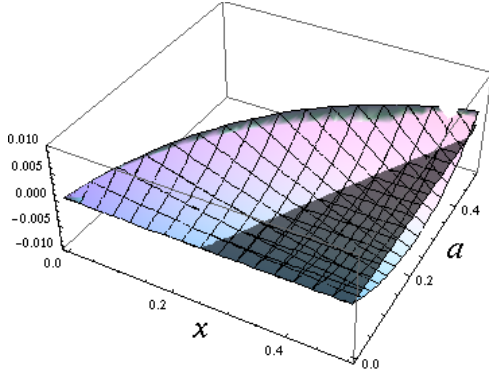
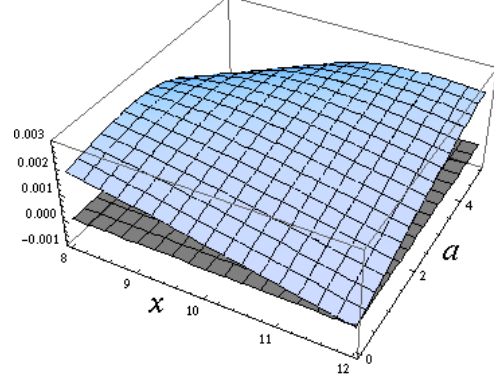
FIG. 3. $V(x; b^*)$ not optimalFIG. 4. $V(x; 0)$ not optimal

well as $V(x; 0)$ are not fixed points of the operator T since the plots show areas above zero, and therefore indeed the barrier-policy can not be optimal.

As an alternative to barrier strategies, we will now study in some detail a simple band policy which will turn out to be the optimal strategy:

7.1. A simple band-policy. Consider the compound Poisson model with exponentially distributed inter-observation times (parameter $\gamma > 0$), but general continuous claim size distribution function F . The simplest non-trivial band-policy is then given by $\pi = (f, f, \dots)$ with parameters $0 \leq c_0 < d_1 \leq c_1$, i.e.

$$f(x) = \begin{cases} 0, & \text{if } x \leq c_0 \\ x - c_0, & \text{if } c_0 < x < d_1 \\ 0, & \text{if } d_1 \leq x \leq c_1 \\ x - c_1, & \text{if } x > c_1. \end{cases}$$

Let us start with the case when there is no observation at time 0, and denote by $\tilde{V}(x; \pi)$ the corresponding expected discounted dividend payments due to band-policy π . Conditioning on either having a claim before an observation event, an observation event before a claim, or neither of them in a time interval $(0, h)$, we obtain

$$\begin{aligned} \tilde{V}(x; \pi) = & \int_0^h e^{-(\delta+\lambda+\gamma)t} \left[\lambda \int_0^\infty \tilde{V}(x+ct-y; \pi) dF(y) + \gamma \left[\tilde{V}(x+ct; \pi) I_{\{0 \leq x+ct \leq c_0 \vee d_1 \leq x+ct \leq c_1\}} \right. \right. \\ & \left. \left. + (x+ct-c_0 + \tilde{V}(c_0; \pi)) I_{\{c_0 < x+ct < d_1\}} + (x+ct-c_1 + \tilde{V}(c_1; \pi)) I_{\{c_1 < x+ct\}} \right] \right] dt + e^{-(\delta+\lambda+\gamma)h} \tilde{V}(x+ch; \pi). \end{aligned} \quad (7.1)$$

Letting $h \rightarrow 0$, one sees that $\tilde{V}(x; \pi)$ is right-continuous in x . The same argument for initial capital $x - ch$ also gives left-continuity and so $\tilde{V}(x; \pi)$ is continuous in x . From (7.1) it is also clear that the one-sided derivatives of \tilde{V} exist for all $x \in \mathbb{R}$ and moreover $\tilde{V}(x; \pi)$ is differentiable within the layers of the given band-policy, i.e. for at least $x \in \mathbb{R} \setminus \{0, c_0, d_1, c_1\}$. Taking the

derivative with respect to h and letting h tend to zero we arrive at the system of integro-differential equations

$$\begin{aligned}
0 &= c \frac{d}{dx} \tilde{V}(x; \pi) - (\delta + \lambda + \gamma) \tilde{V}(x; \pi) + \lambda \int_0^\infty \tilde{V}(x - y; \pi) dF(y), \quad x < 0, \\
0 &= c \frac{d}{dx} \tilde{V}(x; \pi) - (\delta + \lambda) \tilde{V}(x; \pi) + \lambda \int_0^\infty \tilde{V}(x - y; \pi) dF(y), \quad 0 < x < c_0, \\
0 &= c \frac{d}{dx} \tilde{V}(x; \pi) - (\delta + \lambda + \gamma) \tilde{V}(x; \pi) + \lambda \int_0^\infty \tilde{V}(x - y; \pi) dF(y) + \gamma[x - c_0 + \tilde{V}(c_0; \pi)], \quad c_0 < x < d_1, \\
0 &= c \frac{d}{dx} \tilde{V}(x; \pi) - (\delta + \lambda) \tilde{V}(x; \pi) + \lambda \int_0^\infty \tilde{V}(x - y; \pi) dF(y), \quad d_1 < x < c_1, \\
0 &= c \frac{d}{dx} \tilde{V}(x; \pi) - (\delta + \lambda + \gamma) \tilde{V}(x; \pi) + \lambda \int_0^\infty \tilde{V}(x - y; \pi) dF(y) + \gamma[x - c_1 + \tilde{V}(c_1; \pi)], \quad c_1 < x.
\end{aligned}$$

Since $\tilde{V}(x; \pi)$ is continuous, it follows that $\tilde{V}(x; \pi)$ is differentiable in c_0 (if $c_0 > 0$) and c_1 but not in 0 and d_1 . Define

$$\tilde{V}(x; \pi) = \begin{cases} V_L(x; \pi) & \text{if } x < 0 \\ V_{M_1}(x; \pi) & \text{if } 0 \leq x \leq c_0 \\ V_{M_2}(x; \pi) & \text{if } c_0 < x < d_1 \\ V_{M_3}(x; \pi) & \text{if } d_1 \leq x \leq c_1 \\ V_U(x; \pi) & \text{if } x > c_1. \end{cases}$$

One then can rewrite the above system of integro-differential equations to

$$\begin{aligned}
0 &= c \frac{d}{dx} V_L(x; \pi) - (\delta + \lambda + \gamma) V_L(x; \pi) + \lambda \int_0^\infty V_L(x - y; \pi) dF(y), \quad x < 0, \\
0 &= c \frac{d}{dx} V_{M_1}(x; \pi) - (\delta + \lambda) V_{M_1}(x; \pi) + \lambda \int_0^x V_{M_1}(x - y; \pi) dF(y) + \lambda \int_x^\infty V_L(x - y; \pi) dF(y), \quad 0 < x < c_0, \\
0 &= c \frac{d}{dx} V_{M_2}(x; \pi) - (\delta + \lambda + \gamma) V_{M_2}(x; \pi) + \lambda \int_0^{x-c_0} V_{M_2}(x - y; \pi) dF(y) + \lambda \int_{x-c_0}^x V_{M_1}(x - y; \pi) dF(y) \\
&\quad + \lambda \int_x^\infty V_L(x - y; \pi) dF(y) + \gamma[x - c_0 + V_{M_1}(c_0; \pi)], \quad c_0 < x < d_1, \\
0 &= c \frac{d}{dx} V_{M_3}(x; \pi) - (\delta + \lambda) V_{M_3}(x; \pi) + \lambda \int_0^{x-d_1} V_{M_3}(x - y; \pi) dF(y) + \lambda \int_{x-d_1}^{x-c_0} V_{M_2}(x - y; \pi) dF(y) \\
&\quad + \lambda \int_{x-c_0}^x V_{M_1}(x - y; \pi) dF(y) + \lambda \int_x^\infty V_L(x - y; \pi) dF(y), \quad d_1 < x < c_1, \\
0 &= c \frac{d}{dx} V_U(x; \pi) - (\delta + \lambda + \gamma) V_U(x; \pi) + \lambda \int_0^{x-c_1} V_U(x - y; \pi) dF(y) + \lambda \int_{x-c_1}^{x-d_1} V_{M_3}(x - y; \pi) dF(y) \\
&\quad + \lambda \int_{x-d_1}^{x-c_0} V_{M_2}(x - y; \pi) dF(y) + \lambda \int_{x-c_0}^x V_{M_1}(x - y; \pi) dF(y) + \lambda \int_x^\infty V_L(x - y; \pi) dF(y) \\
&\quad + \gamma[x - c_1 + V_{M_3}(c_1; \pi)], \quad c_1 < x,
\end{aligned}$$

with the pasting conditions

$$\begin{aligned} V_L(0; \pi) &= V_{M_1}(0; \pi), & V_{M_1}(c_0; \pi) &= V_{M_2}(c_0; \pi), & V_{M_2}(d_1; \pi) &= V_{M_3}(d_1; \pi), \\ V_{M_3}(c_1; \pi) &= V_U(c_1; \pi), & \frac{d}{dx} V_{M_1}(c_0; \pi) &= \frac{d}{dx} V_{M_2}(c_0; \pi), & \frac{d}{dx} V_{M_3}(c_1; \pi) &= \frac{d}{dx} V_U(c_1; \pi). \end{aligned}$$

Note that V_{M_1} is not needed if $c_0 = 0$. In addition, we have the natural boundary conditions that $\lim_{x \rightarrow -\infty} V_L(x; \pi) = 0$ and $V_U(x; \pi)$ is linearly bounded for $x \rightarrow \infty$ (cf. Lemma 3.1). This uniquely determines the solution of the above system of integro-differential equations.

Finally, if time zero is also an observation time, the value of the present policy π , denoted by $V(x; \pi)$, is given by

$$V(x; \pi) = \begin{cases} 0, & \text{if } x < 0, \\ V_{M_1}(x; \pi) & \text{if } 0 \leq x \leq c_0, \\ x - c_0 + V_{M_1}(c_0; \pi), & \text{if } c_0 < x < d_1, \\ V_{M_3}(x; \pi), & \text{if } d_1 \leq x \leq c_1, \\ x - c_1 + V_{M_3}(c_1; \pi), & \text{if } x > c_1. \end{cases} \quad (7.2)$$

7.2. Explicit example with optimal band-policy. Let us now return to the numerical example given in the beginning of Section 7 with Erlang(2, ν) distributed claims U_i (i.e. density function $f(y) = \nu^2 y e^{-\nu y} I_{\{y \geq 0\}}$) and apply the simple band strategy. For this choice of claim size distribution, it is possible to convert, by standard methods, the system of integro-differential equations characterizing $\tilde{V}(x; \pi)$ into a system of ordinary differential equations with constant coefficients. By using the associated characteristic equations we get that the solutions are of the following form:

$$\begin{aligned} V_L(x; \pi) &= A_1 e^{R_1 x}, \\ V_{M_1}(x; \pi) &= B_1 e^{S_1 x} + B_2 e^{S_2 x} + B_3 e^{S_3 x}, \\ V_{M_2}(x; \pi) &= C_1 e^{R_1 x} + C_2 e^{R_2 x} + C_3 e^{R_3 x} + C_4 x + C_5, \\ V_{M_3}(x; \pi) &= D_1 e^{S_1 x} + D_2 e^{S_2 x} + D_3 e^{S_3 x}, \\ V_U(x; \pi) &= E_1 e^{R_2 x} + E_2 e^{R_3 x} + E_3 x + E_4. \end{aligned}$$

The exponents $R_1 > 0$, $R_2, R_3 < 0$ are the roots of the polynomial

$$(cR - (\delta + \lambda + \gamma))(R + \nu)^2 + \lambda^2 \nu,$$

whereas S_1, S_2, S_3 are the roots of the polynomial

$$(cS - (\delta + \lambda))(S + \nu)^2 + \lambda^2 \nu.$$

Substitution of these quantities back into the integro-differential equations together with the pasting conditions then gives a system of linear equations for the involved coefficients. This linear system uniquely determines the solution $\tilde{V}(x; \pi)$ and subsequently $V(x; \pi)$ by virtue of (7.2). Even with this explicit form of $V(x; \pi)$ at our disposal, it is very hard to state general conditions under which such a simple band-policy is optimal, since all the involved coefficients are functions of the parameters (c_0, d_1, c_1) , which specify the policy.

But what can be done is to numerically assess the situation for particular parameter settings. Let us hence return to the previous choice $c = 21.4$, $\lambda = 10$, $\nu = 1$, $\delta = 0.1$ and $\gamma = 200$, and retry the procedure for identifying an optimal dividend policy of simple band-type π with parameters c_0, d_1, c_1 . I.e., we first determine a policy π^* that maximizes $V(x; \pi)$ over the set of simple band-type policies. In a second step we then try to verify the fixed point property of

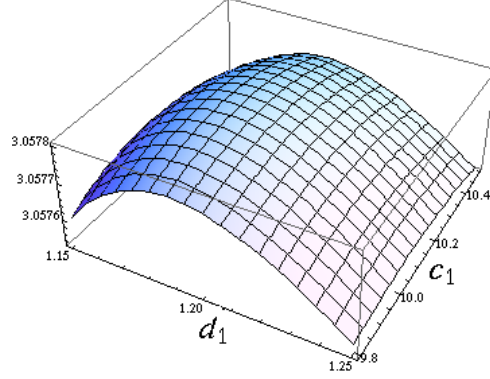
FIG. 5. $V(1; (0, d_1, c_1))$ as function of (d_1, c_1)

the value function stated by the Bellman equation, i.e. $V(x; \pi^*) = \sup_{a \in [0, x]} \left\{ a + \tilde{V}(x - a; \pi^*) \right\}$.

At first one observes that $c_0 = 0$, which is also indicated by the above observation on pure barrier-policies (for small values of initial surplus a barrier in zero was optimal). For deriving d_1 and c_1 we use a numerical optimization procedure (e.g. in Mathematica) to maximize $V(x; \pi)$ for fixed $x \geq 0$ as a function of (d_1, c_1) (w.l.o.g. one can fix any initial surplus $x \geq 0$ for this calculation, since in case of optimality among all dividend policies the values are independent of x). As a result we then obtain π^* with $(c_0, d_1, c_1) = (0, 1.1854, 10.1041)$ for the optimal band parameters within simple band-policies (Figure 5 shows $V(1; \pi)$ as a function of (d_1, c_1) with $c_0 = 0$; one observes that the corresponding surface is very flat around its maximum, values differ by a magnitude of 10^{-4}).

For verifying the general optimality of $\pi^* = (f^*, f^*, \dots)$ with

$$f^*(x) = \begin{cases} 0, & \text{if } x \leq 0, \\ x, & \text{if } 0 < x < 1.1854, \\ 0, & \text{if } 1.1854 \leq x \leq 10.1041, \\ x - 10.1041, & \text{if } x > 10.1041 \end{cases}$$

among all dividend policies, we look at $a + \tilde{V}(x - a; \pi^*) - V(x; \pi^*)$ for all admissible dividend payments $0 \leq a \leq x$. Figures 6 and 7 contain this difference as function in a and x for big/small values of x . Particularly in Figure 7 one can observe that for $0 \leq x < 1.1854$ and subsequently for $1.1854 \leq x < 2$ the difference is maximized by $a(x) = f^*(x)$ and virtually equal to zero, whereas for different values of a it is obviously strictly negative. A plot of the decision rule $f^*(x)$ as a function of x is given in Figure 10. Figure 9 presents the contours of $a + \tilde{V}(x - a; \pi^*) - V(x; \pi^*)$ as a function of x and a , the darker the area the bigger the (negative) difference.

A numerical computation of $TV(x; \pi^*) - V(x; \pi^*)$, which is a reformulation of the Bellman equation, is given in Figure 11. The maximal difference from zero for $x = 0.01k$ with $k = 0, \dots, 1500$ is $4.37616 \cdot 10^{-6}$ and assumed at $x = 0.01$, whereas for larger values of $x > 10.1041$ the difference is of the order 10^{-13} . Therefore we can (numerically) conclude that $V(x; \pi^*) = TV(x; \pi^*)$. We can base this conclusion of the fixed point property on the observation that for fixed x the function $V(x; \pi)$ as a function of $\pi = (c_0, d_1, c_1)$ is very flat around its maximizer. This happens in particular for small values of x , explaining the maximal difference for small x . Furthermore, even if the *optimal* solution would consist of additional bands for $x > 10.1041$, i.e. in areas where $TV(x; \pi^*) - V(x; \pi^*)$ is of order 10^{-13} , one can expect that for its computation numerical errors will overlay the effect of a possible improvement of the value function.

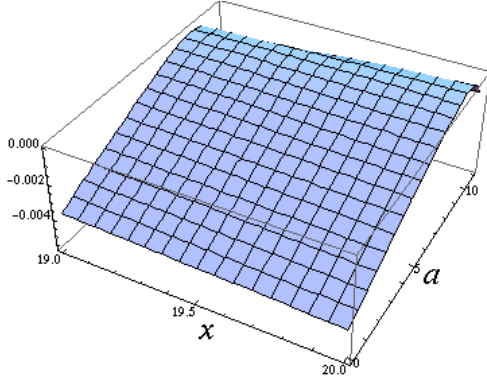
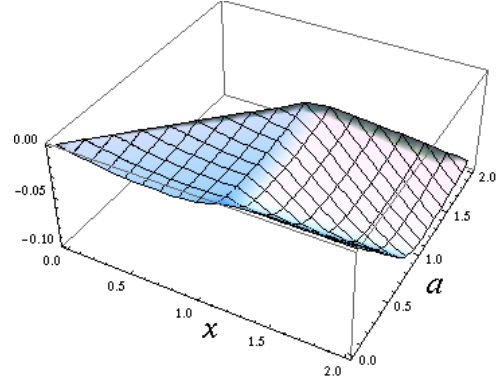
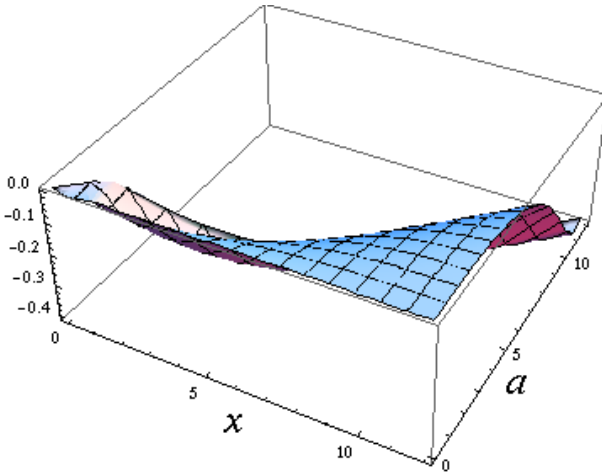
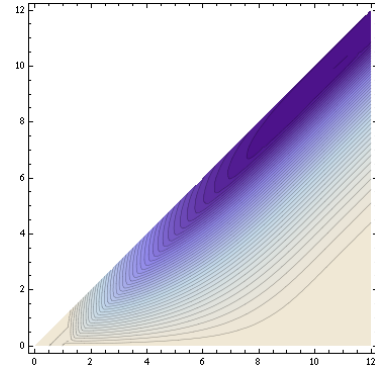
FIG. 6. $a + \tilde{V}(x - a; \pi^*) - V(x; \pi^*)$, large x FIG. 7. $a + \tilde{V}(x - a; \pi^*) - V(x; \pi^*)$, small x FIG. 8. $a + \tilde{V}(x - a; \pi^*) - V(x; \pi^*)$ FIG. 9. $a + \tilde{V}(x - a; \pi^*) - V(x; \pi^*)$, contours

In general the fixed point may not be unique, so that this reasoning would not necessarily imply that $V(x; \pi^*)$ is the optimal value function. However, in our situation the Markov Decision Model is positive (i.e. the paid dividend is non-negative), and, due to Theorem 7.4.5. in Bäuerle & Rieder [5], this is sufficient to prove the optimality of the simple band-policy π^* among all dividend policies in this concrete example.

Finally, note that the optimality of this band-policy is quite vulnerable in the sense that for smaller values of γ (i.e. less frequent observations), the optimal policy again collapses to a barrier-policy. For example, the choice $\gamma = 20$ already results in an optimal barrier-policy with height $b^* = 8.8483$ as indicated by Figures 12–14, which depict $a + \tilde{V}(x - a; b^*) - V(x; b^*)$ for different magnitudes of x as well as Figure 15, which gives $TV(x; b^*) - V(x; b^*)$. From this one may conclude that the optimality of a barrier-policy with $b^* = 8.8483$.

Acknowledgements. We would like to thank an anonymous referee for constructive remarks.

REFERENCES

- [1] H. Albrecher, E.C.K. Cheung, and S. Thonhauser. Randomized observation periods for the compound Poisson risk model: Dividends. *ASTIN Bulletin*, 2011. pending revision.

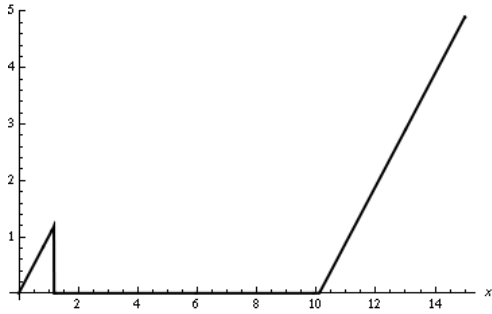
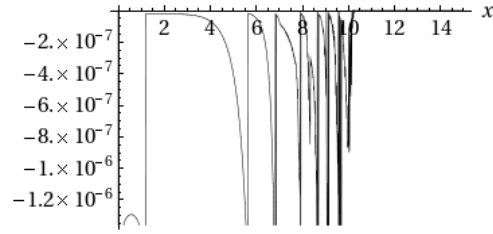
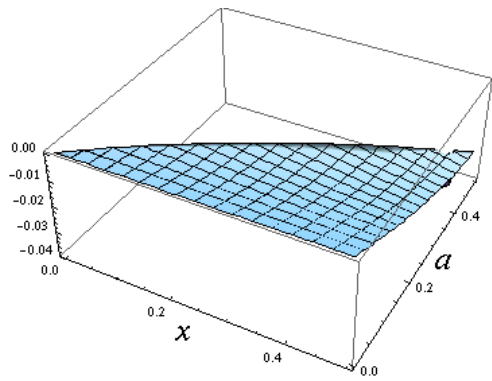
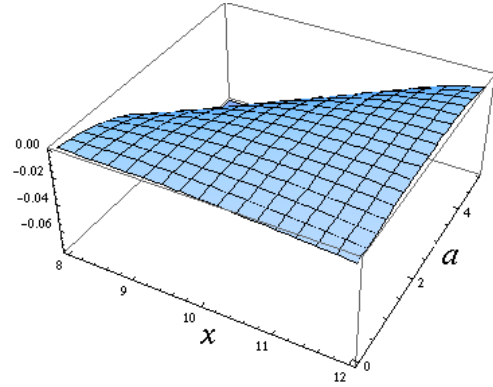
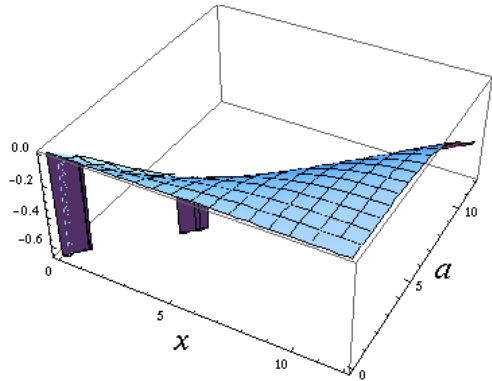
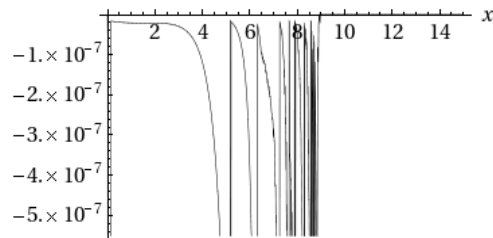
FIG. 10. Optimal policy $f^{\pi^*}(x)$ FIG. 11. $TV(x; \pi^*) - V(x; \pi^*)$ FIG. 12. $a + \tilde{V}(x - a; b^*) - V(x; b^*)$, small x FIG. 13. $a + \tilde{V}(x - a; b^*) - V(x; b^*)$, large x FIG. 14. $a + \tilde{V}(x - a; b^*) - V(x; b^*)$ FIG. 15. $TV(x; b^*) - V(x; b^*)$

- [2] H. Albrecher and S. Thonhauser. Optimality results for dividend problems in insurance. *RACSAM Rev. R. Acad. Cien. Serie A. Mat.*, 103(2):295–320, 2009.
- [3] P. Azcue and N. Muler. Optimal reinsurance and dividend distribution policies in the Cramér-Lundberg model. *Math. Finance*, 15(2):261–308, 2005.
- [4] N. Bäuerle. Approximation of optimal reinsurance and dividend payout policies. *Math. Finance*, 14(1):99–113, 2004.

- [5] N. Bäuerle and U. Rieder. *Markov Decision Processes with Applications to Finance*. Springer, 2011.
- [6] R. Cont and P. Tankov. *Financial Modelling with Jump Processes*. Chapman & Hall/CRC, Boca Raton, FL, 2004.
- [7] B. de Finetti. Su un' impostazione alternativa della teoria collettiva del rischio. *Transactions of the XVth Congress of Actuaries*, (II):433–443, 1957.
- [8] H.U. Gerber. Entscheidungskriterien fuer den zusammengesetzten Poisson-prozess. *Schweiz. Aktuarver. Mitt.*, (1):185–227, 1969.
- [9] J. Grandell. *Aspects of Risk Theory*. Springer, New York, 1991.
- [10] R. Loeffen and J. Renaud. de finetti's optimal dividends problem with an affine penalty function at ruin. *Insurance Math. Econom.*, 46(1):98–108, 2010.
- [11] H. Schmidli. *Stochastic Control in Insurance*. Springer, London, 2008.

(H. Albrecher) DEPARTMENT OF ACTUARIAL SCIENCE, FACULTY OF BUSINESS AND ECONOMICS AND SWISS FINANCE INSTITUTE, UNIVERSITY OF LAUSANNE, CH-1015 LAUSANNE, SWITZERLAND
E-mail address: hansjoerg.albrecher@unil.ch

(N. Bäuerle) INSTITUTE FOR STOCHASTICS, KARLSRUHE INSTITUTE OF TECHNOLOGY, D-76128 KARLSRUHE, GERMANY
E-mail address: nicole.baeuerle@kit.edu

(S. Thonhauser) DEPARTMENT OF ACTUARIAL SCIENCE, FACULTY OF BUSINESS AND ECONOMICS, UNIVERSITY OF LAUSANNE, CH-1015 LAUSANNE, SWITZERLAND
E-mail address: stefan.thonhauser@unil.ch