



KIT SCIENTIFIC REPORTS 7641

State-of-the-Art of High Power Gyro-Devices and Free Electron Masers

Update 2012

Manfred Thumm

Manfred Thumm

State-of-the-Art of High Power Gyro-Devices and Free Electron Masers

Update 2012

Karlsruhe Institute of Technology
KIT SCIENTIFIC REPORTS 7641

State-of-the-Art of High Power Gyro-Devices and Free Electron Masers

Update 2012

by
Manfred Thumm

Institut für Hochleistungsimpuls- und Mikrowellentechnik
Programm FUSION
Association EURATOM-KIT

Report-Nr. KIT-SR 7641

Impressum

Karlsruher Institut für Technologie (KIT)
KIT Scientific Publishing
Straße am Forum 2
D-76131 Karlsruhe
www.ksp.kit.edu

KIT – Universität des Landes Baden-Württemberg und
nationales Forschungszentrum in der Helmholtz-Gemeinschaft



Diese Veröffentlichung ist im Internet unter folgender Creative Commons-Lizenz
publiziert: <http://creativecommons.org/licenses/by-nc-nd/3.0/de/>

KIT Scientific Publishing 2013
Print on Demand

Contents

1	Introduction	1
2	Classification of Fast-Wave Microwave Sources	2
3	Dispersion Diagrams of Fast Cyclotron Mode Interaction	3
3.1	Gyrotron Oscillator and Gyroklystron Amplifier	4
3.2	Cyclotron Autoresonance Maser (CARM)	7
3.3	Gyro-TWT (Travelling Wave Tube) and Gyrotwystron Amplifier	9
3.4	Gyro-BWO (Backward Wave Oscillator)	10
3.5	Overview on Gyro-Devices	11
4	Magnicons and Gyroharmonic Converters	12
5	Free Electron Masers	14
6	Gyrotron Oscillators and Microwave Vacuum Windows for Plasma Heating	16
7	Harmonic and Very High Frequency Gyrotron Oscillators	27
8	Gyrotrons for Technological Applications	30
9	Relativistic Gyrotrons	31
10	Quasi-Optical Gyrotrons	32
11	Cyclotron Autoresonance Masers (CARMs)	33
12	Gyroklystrons, Gyro-TWTs, Gyrotwystrons, Gyro-BWOs and other Gyro-Devices	34
13	Free Electron Masers (FEMs)	40
14	Comparison of Gyrotron and FEM for Nuclear Fusion	43
	Acknowledgments	44
	References	45-133

**STATE-OF-THE-ART OF HIGH POWER GYRO-DEVICES
AND FREE ELECTRON MASERS
UPDATE 2012**

Abstract

Gyrotron oscillators (gyromonotrons) are mainly used as high power millimeter wave sources for electron cyclotron resonance heating (ECRH), electron cyclotron current drive (ECCD), stability control and diagnostics of magnetically confined plasmas for generation of energy by controlled thermonuclear fusion. The maximum pulse length of commercially available 140 GHz, megawatt-class gyrotrons employing synthetic diamond output windows is 30 minutes (CPI and European KIT-CRPP-CEA-TED collaboration). The world record parameters of the European megawatt-class 140 GHz gyrotron are: 0.92 MW output power at 30 min. pulse duration, 97.5% Gaussian mode purity and 44% efficiency, employing a single-stage depressed collector (SDC) for energy recovery. A maximum output power of 1.5 MW in 4.0 s pulses at 45% efficiency was generated with the JAEA-TOSHIBA 110 GHz gyrotron. The Japan 170 GHz ITER gyrotron achieved 1 MW, 800 s at 55% efficiency and holds the energy world record of 2.88 GJ (0.8 MW, 60 min.) and the efficiency record of 57% for tubes with an output power of more than 0.5 MW. The Russian 170 GHz ITER gyrotron achieved 0.9 MW with a pulse duration of 1000 s and 55% efficiency. The prototype tube of the European 2 MW, 170 GHz coaxial-cavity gyrotron for ITER achieved in short pulses the record power of 2.05 MW at 46% efficiency and 96% Gaussian mode purity. Russian gyrotrons for plasma diagnostics or spectroscopy applications deliver $P_{\text{out}} = 40$ kW with $\tau = 40$ μ s at frequencies up to 650 GHz ($\eta \geq 4\%$), $P_{\text{out}} = 5.3$ kW at 1 THz ($\eta = 6.1\%$), and $P_{\text{out}} = 0.5$ kW at 1.3 THz ($\eta = 0.6\%$). Gyrotron oscillators have also been successfully used in materials processing. Such technological applications require gyrotrons with the following parameters: $f \geq 24$ GHz, $P_{\text{out}} = 4$ -50 kW, CW, $\eta \geq 30\%$. This paper gives an update of the experimental achievements related to the development of high power gyrotron oscillators for long pulse or CW operation and pulsed gyrotrons for various applications. In addition, this work gives a short overview of the present development status of coaxial-cavity multi-megawatt gyrotrons, gyrotrons for technological and spectroscopy applications, relativistic gyrotrons, quasi-optical gyrotrons, fast- and slow-wave cyclotron autoresonance masers (CARMs), gyroklystrons, gyro-TWT amplifiers, gyrotwyston amplifiers, gyro-BWO's, gyropeniotrons, magnicons, gyroharmonic converters, free electron masers (FEMs) and of vacuum windows for such high-power mm-wave sources. The highest CW powers produced by gyroklystrons and FEMs are, respectively, 10 kW (94 GHz) and 36 W (15 GHz). The IR FEL at the Thomas Jefferson National Accelerator Facility in the USA obtained a record average power of 14.2 kW at a wavelength of 1.6 μ m. The THz FEL (NOVEL) at the Budker Institute of Nuclear Physics in Russia obtained a maximum average power of 0.5 kW in the wavelength range 50-240 μ m (6.00-1.25 THz).

KIT is a University of the State of Baden-Württemberg and a National Laboratory of the Helmholtz Association.

Please send corrections, completions and supplements to
manfred.thumm@kit.edu

STATUS DER ENTWICKLUNG VON HOCHLEISTUNGS-GYRO-RÖHREN UND FREI-ELEKTRONEN-MASERN STAND: ENDE 2012

Zusammenfassung

Gyrotronoszillatoren (Gyromonotrons) werden vorwiegend als Hochleistungsmillimeterwellenquellen für Elektron-Zyklotron-Resonanzheizung (ECRH), Elektron-Zyklotron-Stromtrieb (ECCD), Stabilitätskontrolle und Diagnostik von magnetisch eingeschlossenen Plasmen zur Erforschung der Energiegewinnung durch kontrollierte Kernfusion eingesetzt. Die maximale Pulslänge von kommerziell erhältlichen 140 GHz, 1 Megawatt Gyrotrons mit Austrittsfenstern aus künstlichem Diamant ist 30 min. (CPI und Europäische KIT-CRPP-TED-CEA Arbeitsgemeinschaft). Die Weltrekordparameter des europäischen 140 GHz-Megawatt-Gyrotrons sind: 0,92 MW Ausgangsleistung bei 30 min. Pulslänge, 97,5% Gaußsche Modenreinheit und 44% Wirkungsgrad mittels eines Kollektors mit einstufiger Gegenspannung (SDC) zur Energierückgewinnung. Eine maximale Ausgangsleistung von 1,5 MW bei 4,0 s Pulslänge und 45% Wirkungsgrad wurden mit dem JAEA-TOSHIBA 110 GHz Gyrotron erzeugt. Das japanische 170 GHz ITER-Gyrotron erreichte 1 MW, 800 s bei 55% Wirkungsgrad und hält den Energieweltrekord mit 2,88 GJ (0,8 MW, 60 min.) und den Wirkungsgradrekord mit 57% für Röhren mit einer Ausgangsleistung höher als 0,5 MW. Das russische 170 GHz ITER-Gyrotron erreichte 0,9 MW bei 1000 s Pulslänge und 55% Wirkungsgrad. Das Prototyp-Gyrotron des europäischen 2 MW, 170 GHz ITER Gyrotrons mit koaxialem Resonator erzielte in Kurzpulsen die Rekordleistung von 2,05 MW bei 46% Wirkungsgrad und 96% Gaußscher Modenreinheit. Russische Gyrotrons zur Plasmadiagnostik oder für spektroskopische Anwendungen arbeiten bei Frequenzen bis zu 650 GHz bei $P_{\text{out}} = 40 \text{ kW}$ und $\tau = 40 \mu\text{s}$ ($\eta \geq 4\%$), $P_{\text{out}} = 5,3 \text{ kW}$ bei 1 THz ($\eta = 6,1\%$) und $P_{\text{out}} = 0,5 \text{ kW}$ bei 1,3 THz ($\eta = 0,6\%$). Gyrotronoszillatoren finden jedoch auch in der Materialprozeßtechnik erfolgreich Verwendung. Dabei werden Röhren mit folgenden Parametern eingesetzt: $f \geq 24 \text{ GHz}$, $P_{\text{out}} = 4\text{-}50 \text{ kW}$, CW, $\eta \geq 30\%$. In diesem Beitrag wird auf den aktuellen experimentellen Stand bei der Entwicklung von Hochleistungs-Gyrotronoszillatoren für Langpuls- und Dauerstrichbetrieb sowie von gepulsten Gyrotrons für verschiedene Anwendungen eingegangen. Außerdem wird auch kurz über den neuesten Stand der Entwicklung von Multimegawatt-Gyrotrons mit koaxialem Resonator, Gyrotrons für technologische und spektroskopische Anwendungen, relativistischen Gyrotrons, quasi-optischen Gyrotrons, Zyklotron-Autoresonanz-Masern (CARMs) mit schneller oder langsamer Welle, Gyroklystrons, Gyro-TWT-Verstärkern, Gyrotwystron-Verstärkern, Gyro-Rückwärtswellenoszillatoren (BWOs), Gyro-Peniotrons, Magnicon-Verstärkern, Gyro-Harmonische-Konvertoren, Frei-Elektronen-Masern (FEM) und von Vakuumfenstern für solche Hochleistungsmillimeterwellenquellen berichtet. Die höchsten von Gyroklystrons und FEMs erzeugten CW-Leistungen sind 10 kW (94 GHz) bzw. 36 W (15 GHz). Der IR FEL der Thomas Jefferson National Accelerator Facility in den USA erreichte eine Rekord-Durchschnittsleistung von 14,2 kW bei einer Wellenlänge von 1,6 μm . Der THz FEL (NovoFEL) am Budker Institute of Nuclear Physics in Russland erzielte die maximale Durchschnittsleistung von 0,5 kW im Wellenlängenbereich 50-240 μm (6,00-1,25 THz).

KIT – Universität des Landes Baden-Württemberg und Nationales Forschungszentrum in der Helmholtz-Gemeinschaft.

Bitte schicken Sie Korrekturen, Vervollständigungen und Ergänzungen an
manfred.thumm@kit.edu

1 Introduction

The possible applications of gyrotron oscillators and other electron cyclotron maser (ECM) fast-wave devices span a wide range of technologies [1-7]. The plasma physics community has already taken advantage of recent advances in producing high power micro- and millimeter (mm) waves in the areas of RF plasma applications for magnetic confinement fusion studies, such as lower hybrid current drive (1-8 GHz), electron cyclotron resonance heating and current drive (28-170 GHz), plasma production for numerous different processes and plasma diagnostic measurements such as collective Thomson scattering or heat-pulse propagation experiments. Other applications which await the development of novel high power mm-wave sources include deep-space and specialized satellite communication, high-resolution Doppler radar, radar ranging and imaging in atmospheric and planetary science, drivers for next-generation high-gradient linear accelerators, ECR ion sources, submillimeter-wave and THz spectroscopy, materials processing and plasma chemistry.

Most work on ECM devices has investigated the conventional gyrotron oscillator (gyromonotron) [8-26] in which the wave vector of the radiation in an open-ended, irregular cylindrical waveguide cavity is almost transverse to the direction of the applied magnetic field, resulting in radiation near the electron cyclotron frequency or at one of its harmonics. Long pulse and CW gyrotron oscillators delivering output powers of 0.1-1.0 MW at frequencies between 28 and 170 GHz have been used very successfully in thermonuclear fusion research for plasma ionization and start-up, electron cyclotron resonance heating (ECRH) and local current density profile control by noninductive electron cyclotron current drive (ECCD) at system power levels up to 4.5 MW.

ECRH has become a well-established heating method for both tokamaks [27-49] and stellarators [49-64]. The confining magnetic fields in present day fusion devices are in the range of $B_0=1-3.6$ Tesla. As fusion machines become larger and operate at higher magnetic field ($B_0 \cong 6$ T) and higher plasma densities in steady state, it is necessary to develop CW gyrotrons that operate at both higher frequencies and higher mm-wave output powers. The requirements of the projected tokamak experiment ITER (International Thermonuclear Experimental Reactor) and of the future new stellarator (W7-X) at the Division of the Max-Planck-Institut für Plasmaphysik in Greifswald are between 10 and 40 MW at frequencies between 140 GHz and 170 GHz [22,25,26,28,34,47,49-60,65-72]. This suggests that mm-wave gyrotrons that generate output power of at least 1 MW, CW, per unit are required. Since efficient ECRH needs axisymmetric, narrow, pencil-like mm-wave beams with well defined polarization (linear or elliptical), single-mode gyrotron emission is necessary in order to generate a TEM_{00} Gaussian beam mode. Single-mode 110-170 GHz gyromonotrons with conventional cylindrical cavity, capable of 1 MW per tube, CW [22-26], and 2 MW coaxial-cavity gyrotrons [70-73] are currently under development. There has been continuous progress towards higher frequency and power but the main issues are still the long pulse or CW operation and the appropriate mm-wave vacuum window. The availability of sources with fast frequency tunability would permit the use of a simple, non-steerable mirror antenna at the plasma torus for local current drive experiments [25,34,74]. Frequency tuning has been shown to be possible on quasi-optical Fabry-Perot cavity gyrotrons [75,76] as well as on cylindrical cavity gyrotrons with step tuning (different operating cavity modes) [77-102].

This work reports on the status and future prospects of gyrotron oscillators and RF vacuum windows for ECRH and ECR plasma sources for generation of multi-charged ions and soft X-rays [103-110] (Tables II-XII), the development of very high frequency gyromonotrons for active plasma diagnostics [111-144], high-frequency sub-millimeter wave spectroscopy in various fields [145-196], remote detection of concealed radioactive materials [197,198] and medical applications [199-201] (Tables XIII-XVI) and of quasi-optical gyrotrons (Table XX).

Gyrotron oscillators also are successfully utilized in materials processing (e.g. advanced ceramic sintering, surface hardening or dielectric coating of metals and alloys) as well as in plasma chemistry [1-6,202-215]. The use of gyrotrons for such technological applications appears to be of interest if one can realize a relatively simple, low cost device which is easy in service (such as a magnetron). Gyrotrons with low magnetic field (operated at the 2nd harmonic of the electron cyclotron frequency), low anode voltage, high efficiency and long lifetime are under development. Mitsubishi in Japan and Gycom in Russia are also employing permanent magnet systems [209,212-222]. The state-of-the-art in this area of gyrotrons for technological applications is summarized in Table XVII.

The next generation of high-energy physics accelerators and the next frontier in understanding of elementary particles is based on the supercollider. For normal-conducting linear electron-positron colliders that will reach center-of-mass energies of > 1 TeV sources at 17 to 35 GHz with $P_{\text{out}} = 300$ MW, $\tau = 0.2$ μs and characteristics that will allow approximately 1000 pulses per second will be necessary as drivers [223-225]. These must be phase-coherent devices, which can be either amplifiers or phase locked oscillators. Such generators are also required for super-range high-resolution radar and atmospheric sensing [226-235]. Therefore this report gives an overview of the present development status of relativistic gyrotrons (Tables XVIII and XIX), fast- and slow-wave cyclotron autoresonance masers (CARM) (Tables XXI and XXII), gyroklystrons (Table XXIII and XXIV), gyrotron travelling wave tube amplifiers (Gyro-TWT) (Tables XXV and XXVI), gyrotwistrons (Table XXVII), peniotrons and gyropeniotrons (Tables XXIX and XXX) and magnicons (Table XXXI) for such purposes as well as of free electron masers (FEM) (Table XXXII) and broadband gyrotron backward wave oscillators (Gyro-BWO) (Table XXVIII) for use as drivers for FEM amplifiers.

The present report updates the experimental achievements in the development of gyro-devices and free electron masers reviewed in [3-7,22-26,65-70], in KfK Report 5235 (Oct 1993), FZKA Reports 5564 (Apr 1995), 5728 (Mar 1996), 5877 (Feb 1997), 6060 (Feb 1998), 6224 (Jan 1999), 6418 (Feb 2000), 6588 (Mar 2001), 6708 (Feb 2002), 6815 (Feb 2003), 6957 (Feb 2004), 7097 (Feb 2005), 7198 (Feb 2006), 7289 (Feb 2007), 7392 (Mar 2008), 7467 (Apr 2009), KIT Scientific Report 7540 (2010), 7575 (2011) and 7606 (2012) with the same title.

2 Classification of Fast-Wave Microwave Sources

Fast-wave devices in which the phase velocity v_{ph} of the electromagnetic wave is greater than the speed of light c , generate or amplify coherent electromagnetic radiation by stimulated emission of bremsstrahlung from a beam of relativistic electrons. The electrons radiate because they undergo oscillations transverse to the direction of beam motion by the action of an external force (field). For such waves the electric field is mainly transverse to the propagation direction.

The condition for coherent radiation is that the contribution from the electrons reinforce the original emitted radiation in the oscillator or the incident electromagnetic wave in the amplifier. This condition is satisfied if a bunching mechanism exists to create electron density variations of a size comparable to the wavelength of the imposed electromagnetic wave. To achieve such a mechanism, a resonance condition must be satisfied between the periodic motion of the electrons and the electromagnetic wave in the interaction region [18,21,236]

$$\omega - k_z v_z \cong s\Omega \quad , \quad s = 1, 2, \dots \quad (k_z v_z = \text{Doppler term}) \quad (1)$$

here ω and k_z are the wave angular frequency and characteristic axial wavenumber, respectively, v_z is the translational electron drift velocity, Ω is an effective frequency, which is associated with macroscopic oscillatory motion of the electrons, and s is the harmonic number.

In the electron cyclotron maser (ECM), electromagnetic energy is radiated by relativistic electrons gyrating in an external longitudinal magnetic field. In this case, the effective frequency Ω corresponds to the relativistic electron cyclotron frequency:

$$\Omega_c = \Omega_{co}/\gamma \quad \text{with} \quad \Omega_{co} = eB_0/m_0 \quad \text{and} \quad \gamma = [1 - (v/c)^2]^{-1/2} \approx 1 + eV_0 / m_0c^2 = 1 + eV_0/511 \quad (2)$$

where $-e$ and m_0 are the charge and rest mass of an electron, γ is the relativistic factor, B_0 is the magnitude of the guide magnetic field and V_0 is the acceleration voltage in kV. The nonrelativistic electron cyclotron frequency is $f_{co} / \text{GHz} = 28 B_0 / \text{T}$. A group of relativistic electrons gyrating in a strong magnetic field will radiate coherently due to bunching caused by the relativistic mass dependence of their gyration frequency. Bunching is achieved because, as an electron loses energy, its relativistic mass decreases and it thus gyrates faster. The consequence is that a small amplitude wave's electric field, while extracting energy from the particles, causes them to become bunched in gyration phase and reinforces the existing wave electric field. The strength of the magnetic field determines the radiation frequency.

In the case of a spatially periodic magnetic or electric field (undulator/wiggler), the transverse oscillation frequency Ω_b (bounce frequency) of the moving charges is proportional to the ratio of the electron beam velocity v_z to the wiggler field spatial period λ_w . Thus,

$$\Omega_b = k_w v_z, \quad k_w = 2\pi/\lambda_w \quad (3)$$

The operating frequency of such devices, an example of which is the free electron maser (FEM) [237-241], is determined by the condition that an electron in its rest frame "observes" both the radiation and the periodic external force at the same frequency. If the electron beam is highly relativistic, ($v_{ph} \cong v_z \cong c$) the radiation will have a much shorter wavelength than the external force in the laboratory frame ($\lambda \cong \lambda_w/2\gamma^2$ so that $\omega \cong 2\gamma^2 \Omega_b$). Therefore, FEMs are capable of generating electromagnetic waves of very short wavelength determined by the relativistic Doppler effect. The bunching of the electrons in FEMs is due to the perturbation of the beam electrons by the ponderomotive potential well which is caused by "beating" of the electromagnetic wave with the spatially periodic wiggler field. It is this bunching that enforces the coherence of the emitted radiation.

In the case of the ECMs and FEMs, unlike most conventional microwave sources and lasers, the radiation wavelength is not determined by the characteristic size of the interaction region. Such fast-wave devices require no periodically rippled walls or dielectric loading and can instead use a simple hollow-pipe oversized waveguide as a circuit. These devices are capable of producing very high power radiation at cm-, mm-, and submillimeter wavelengths since the use of large waveguide or cavity cross sections reduces wall losses and breakdown restrictions, as well as permitting the passage of larger, higher power electron beams. It also relaxes the constraint that the electron beam in a single cavity can only remain in a favourable RF phase for half of a RF period (as in klystrons and other devices employing transition radiation). In contrast with klystrons, the reference phase for the waves in fast wave devices is the phase of the electron oscillations. Therefore, the departure from the synchronous condition, which is given by the transit angle $\theta = (\omega - k_z v_z - s\Omega)L/v_z$, can now be of order 2π or less, even in cavities or waveguides that are many wavelengths long.

3 Dispersion Diagrams of Fast Cyclotron Mode Interaction

The origin of the ECMs traces back to the late 1950s, when three investigators began to examine theoretically the generation of microwaves by the ECM interaction [8,9]: Richard Twiss in Australia [242], Jürgen Schneider in the US [243] and Andrei Gaponov in Russia [244]. A short note on the possibility to use the rotational energy of a helical electron beam for microwave generation was published by the German Hans Kleinwächter in 1950 [245]. In early experiments with devices of this type, there was some debate about the generation mechanism and the relative roles of fast-wave interactions mainly producing azimuthal electron bunching and slow-wave interactions mainly producing axial bunching [8,9,246,247]. The predominance of the fast-wave ECM resonance with its azimuthal bunching in producing microwaves was experimentally verified in the mid-1960s in the US [248] (where the term "electron cyclotron maser" was apparently coined) and in Russia [249].

Many configurations can be used to produce coherent radiation based on the ECM instability. The departure point for designs based on a particular concept is the wave-particle interaction. Dispersion diagrams, also called ω - k_z plots or Brillouin diagrams [250-256], show the region of cyclotron interaction (maximum gain of the instability) between an electromagnetic mode and a fast electron cyclotron mode (fundamental or harmonic) as an intersection of the waveguide mode dispersion curve (hyperbola):

$$\omega^2 = k_z^2 c^2 + k_\perp^2 c^2 \quad (4)$$

with the beam-wave resonance line (straight) given by eq. (1). In the case of a device with cylindrical resonator the perpendicular wavenumber is given by $k_\perp = X_{mn} / R_o$ where X_{mn} is the n th root of the corresponding Bessel function (TM_{mn} modes) or derivative (TE_{mn} modes) and R_o is the waveguide radius. Phase velocity synchronism of the two waves is given in the intersection region. The interaction can result in a device that is either an oscillator or an amplifier. In the following subsections, the different ECM devices are classified according to their dispersion diagrams.

3.1 Gyrotron Oscillator and Gyroklystron Amplifier

Gyrotron oscillators (gyrotrons) were the first ECMs to undergo major development. In September 1964 scientists at IAP Nizhny Novgorod operated the first gyrotron (mode: TE₁₀₁ rectangular cavity, power: 6 W, CW) [18]. In 1966 the term “gyrotron” was coined by Arcady Goldenberg at IAP. Increases in device power were the result of Russian developments from the early 1970s in magnetron injection guns, which produce electron beams with the necessary transverse energy (while minimizing the spread in transverse energies) and in tapered, open-ended waveguide cavities that maximize efficiency by tailoring the electric field distribution in the resonator [8-17]. In 1967 Igor Antakov performed at IAP first gyroklystron experiments.

Gyrotrons and gyroklystrons are devices which usually utilize only weakly relativistic electron beams ($V_o < 100$ kV, $\gamma < 1.2$) with high transverse momentum (pitch angle $\alpha = v_\perp/v_z > 1$) [253-256]. The wavevector of the radiation in the cavity is almost transverse to the direction of the external magnetic field ($k_\perp \gg k_z$, and the Doppler shift is small) resulting, according to eqs. (1) and (2), in radiation near the electron cyclotron frequency or one of its harmonics:

$$\omega \cong s\Omega_c, \quad s = 1, 2, \dots \quad (5)$$

In the case of cylindrical cavity tubes (see Figs. 1 and 2) the operating mode is close to cutoff ($v_{ph} = \omega/k_z \gg c$) and the frequency mismatch $\omega - s\Omega_c$ is small but positive in order to achieve correct phasing, i.e. keeping the electron bunches in the retarding phase [249-256]. The Doppler term $k_z v_z$ is of the order of the gain width and is small compared with the radiation frequency. The dispersion diagrams of fundamental and harmonic gyrotrons are illustrated in Figs. 3 and 4, respectively. The velocity of light line is determined by $\omega = ck_z$. For given values of γ and R_o , a mode represented by X_{mn} and oscillating at frequency ω is only excited over a narrow range of B_o . Quasi-optical gyrotrons employ a Fabry-Perot mirror resonator perpendicular to the electron beam, also providing $k_\perp \gg k_z$ (Fig. 2). By variation of the magnetic field, a sequence of discrete modes can be excited. The frequency scaling is determined by the value of B_o/γ . Modern high-power high-order volume mode CW gyrotron oscillators for fusion plasma applications employ an internal quasi-optical mode converter with lateral microwave output [254-264] and a single-stage depressed collector (SDC) for energy recovery (Tables II-VIII) (Fig.5). Cavity expansion due to ohmic wall heating and electron beam space charge neutralization reduce the operating frequency by a few hundred MHz. Cyclotron harmonic operation reduces the required magnetic field for a given frequency by the factor s . However, the measured efficiencies for gyrotrons operating at higher harmonics ($s = 2$ and 3) are lower than those operating at the fundamental frequency [8-17, 217-222, 250-256].

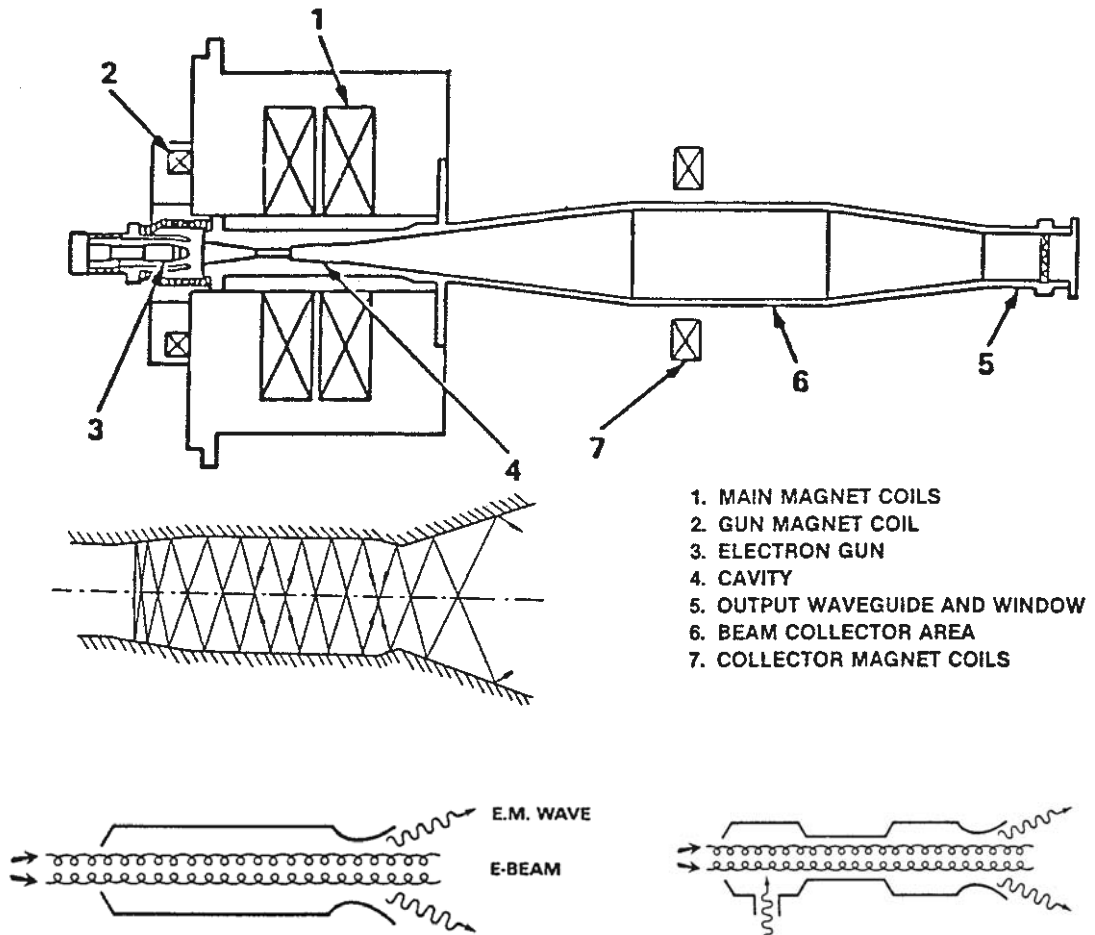

Fig. 1: Schematic of VARIAN CW gyrotron oscillator [14,19] and scheme of irregular waveguide cavities of gyromonotron oscillator (left) and gyrokystron amplifier [251,252].

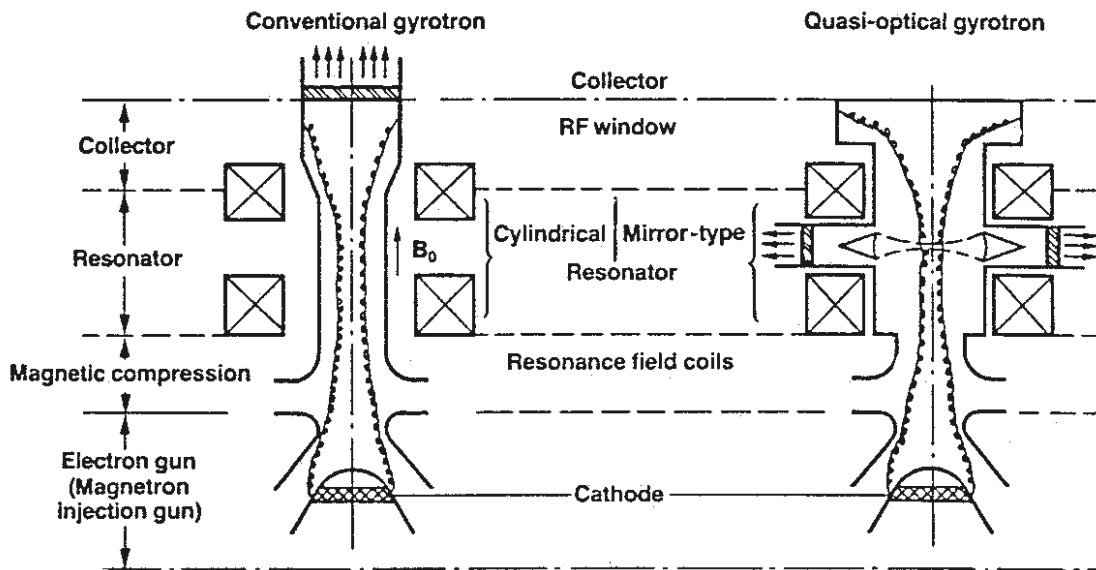

Fig. 2: Principle of a conventional gyrotron with cylindrical resonator and of a quasi-optical gyrotron with mirror resonator [75,76].

At low voltages, the number of electron orbits required for efficient bunching and deceleration of electrons can be large, which means that the resonant interaction has a narrow bandwidth, and that the RF field may have moderate amplitudes. In contrast with this, at high voltages, electrons should execute only about one orbit. This requires correspondingly strong RF fields, possibly leading to RF breakdown, and greatly broadens the cyclotron resonance band, thus making possible an interaction with many parasitic modes.

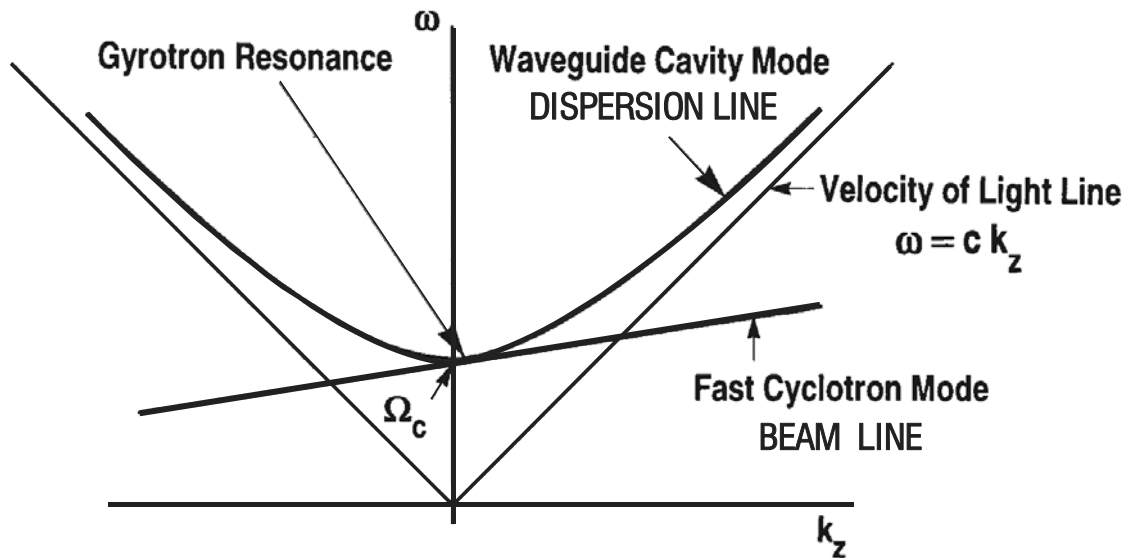

Fig. 3: Dispersion diagram of gyrotron oscillator (fundamental resonance).

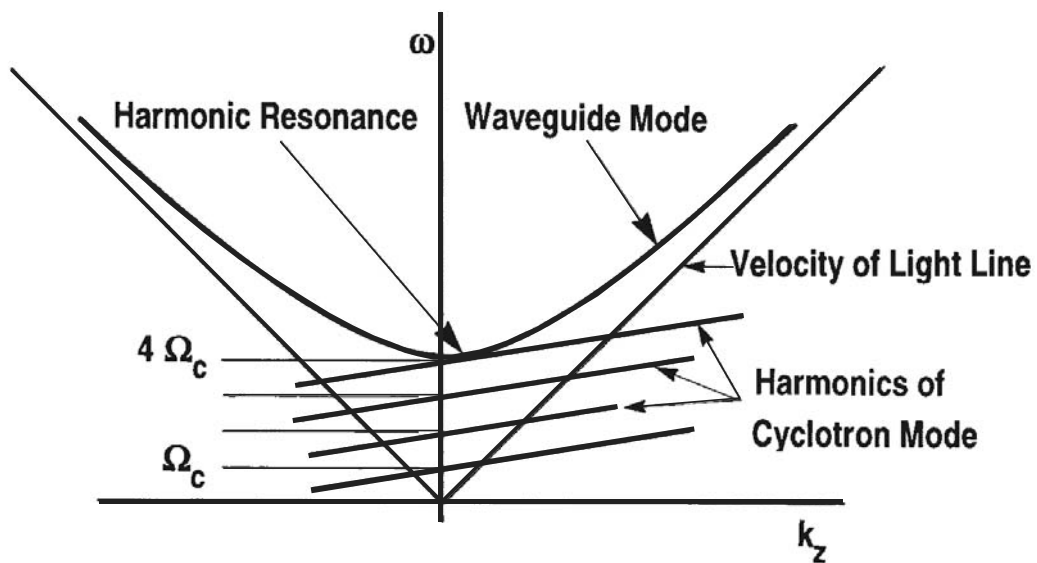

Fig. 4: Dispersion diagram of harmonic frequency gyrotron oscillator.

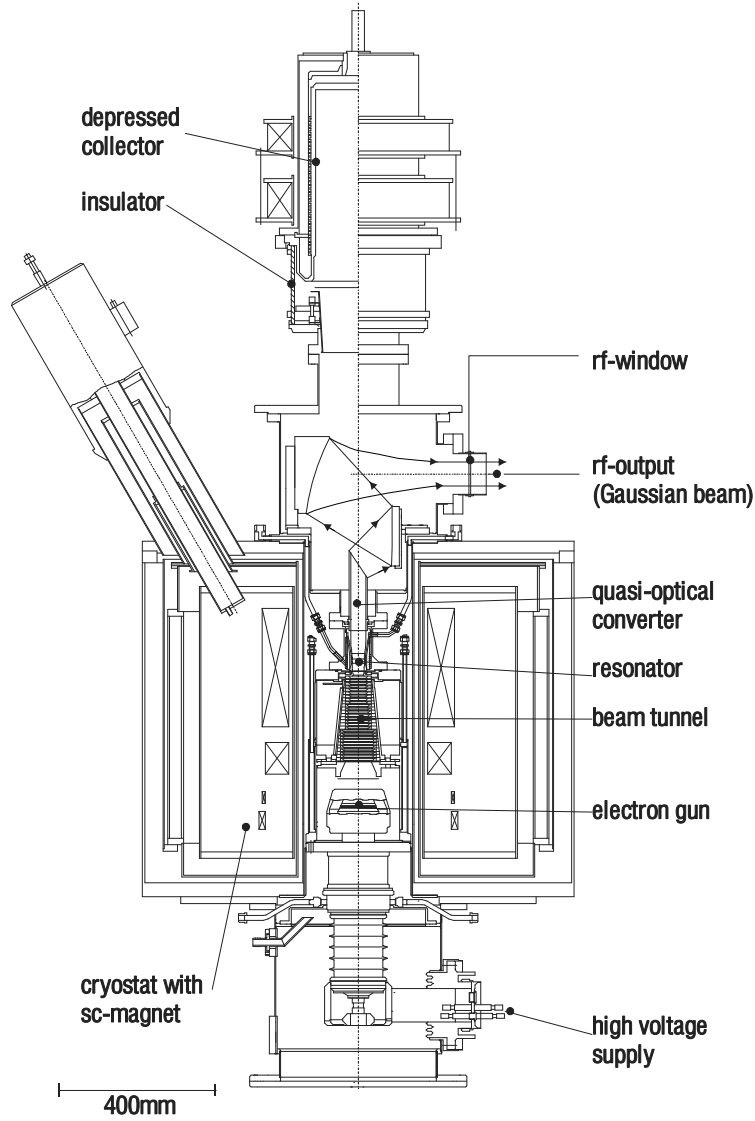

Fig. 5: Schematic layout of modern high-order volume mode gyrotron with quasi-optical mode converter and single-stage depressed collector.

3.2 Cyclotron Autoresonance Maser (CARM)

In a gyrotron with a highly relativistic beam ($\geq 1\text{MeV}$), an efficient interaction will lead to an average energy loss in the order of the initial electron energy. As a result, the change in the gyrofrequency is much greater than in the mildly relativistic case. It is therefore desirable to identify the condition under which such a highly relativistic electron beam remains in synchronism with the RF field. A possibility for achieving synchronism is to utilize the interaction of electrons with electromagnetic waves propagating with a phase velocity close to the speed of light in the direction of the magnetic field. In this case, the Doppler shift term $k_z v_z$ is large, and the appropriate resonance condition is

$$\omega \cong k_z v_z + s\Omega_c \quad (6)$$

If $v_{ph} \cong c$, the increase in cyclotron frequency due to extraction of beam energy (decrease of γ) nearly compensates the decrease in the Doppler-shift term. Therefore, if the resonance condition is initially fulfilled, it will continue to be satisfied during the interaction. This phenomenon is called autoresonance, and the cyclotron maser devices operating in the relativistic Doppler-shifted regime are called cyclotron autoresonance masers [18,236]. Fig. 6 shows how the Brillouin diagram of the fast cyclotron wave changes during the autoresonance

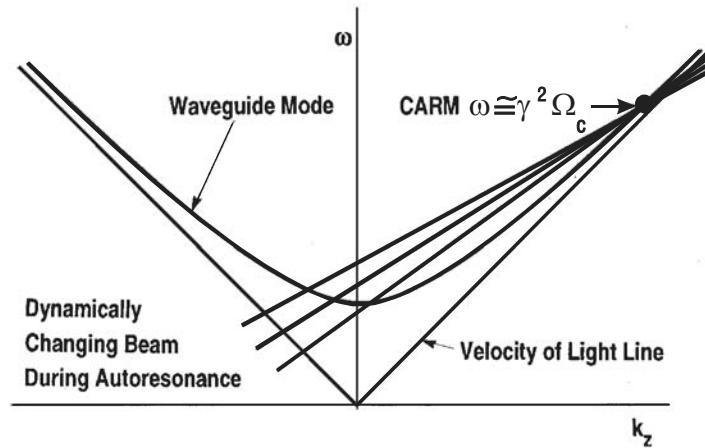

Fig. 6: Dispersion diagram of the cyclotron autoresonance maser (CARM).

interaction such that the working frequency ω remains constant even though both Ω_c and v_z are changing. The CARM interaction corresponds to the upper intersection and is based on the same instability mechanism as that of the gyrotron but operated far above cutoff. The instability is convective, so feedback, e.g. by a Bragg resonator (see Fig. 7) [236] is required for an oscillator and it is necessary to carefully discriminate against the other interactions corresponding to the lower frequency intersection in the dispersion diagram Fig. 6. The problem can be alleviated by employing the fundamental TE_{11} or (HE_{11} hybrid mode) and properly choosing system parameters to be within the stability limit. Compared to a gyrotron, there is a large Doppler frequency upshift of the output ($\omega \cong \gamma^2 \Omega_c$) permitting a considerably reduced magnetic field B_0 . Since the axial bunching mechanism can substantially offset the azimuthal bunching the total energy of the beam and not only the transverse component is available for RF conversion.

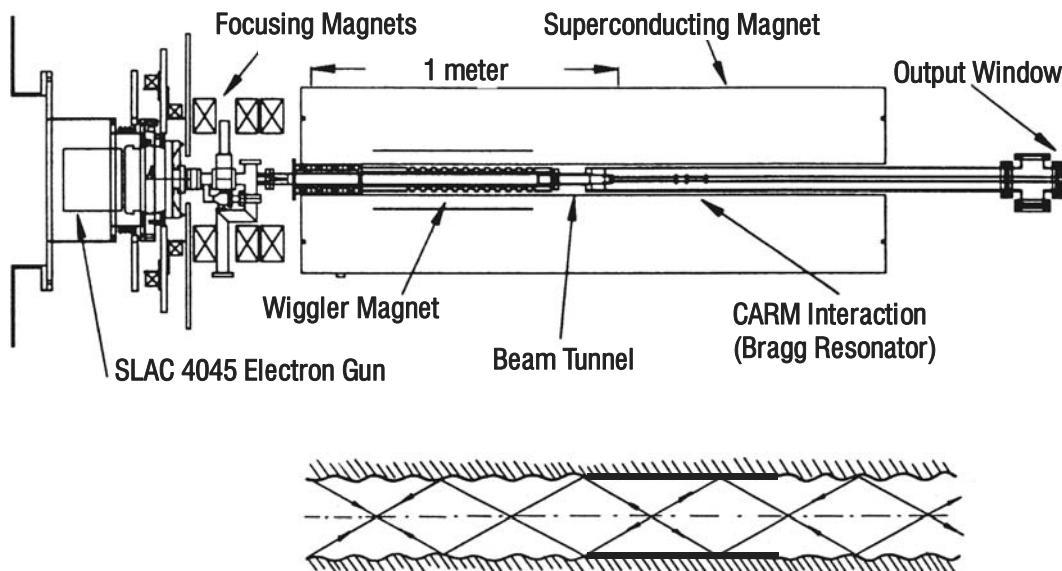

Fig. 7: Schematic of the long-pulse MIT CARM oscillator experiment [266] and scheme of a Bragg resonator [236].

In contrast to the gyrotron the CARM has an electron beam with low to moderate pitch angle ($\alpha < 0.7$). The efficiency of CARMs is extremely sensitive to spread in the parallel beam velocity. The velocity spread $\Delta v_z/v_z$ must be lower than 1% to achieve the full theoretically expected efficiency of 40% [236,266].

It has been suggested that an ECM operating in the Cherenkov regime ($v_{ph} < c$) may be an attractive alternative high-power microwave source. This slow-wave CARM utilizes the coupling between the slow cyclotron wave on the electron beam and the slow electromagnetic waves of the cavity at the anomalous Doppler cyclotron resonance eq. (6) with $s = -1$ or any other negative integer. Such a slow-wave ECM can be driven by an electron beam with predominant axial velocity as in conventional Cherenkov devices. Experimental demonstrations were reported in [267-270], in which dielectric loaded and corrugated waveguide slow-wave structures were used. Since the transverse wavenumber of slow waves is imaginary, their fields are localized near the structure wall, and, therefore, the electron beam should also propagate close to the wall to couple to these waves.

3.3 Gyro-TWT (Travelling Wave Tube) and Gyrotwystron Amplifier

From the theoretical point of view, the gyro-TWT differs from the CARM only in regimes of operation. The gyro-TWT utilizes a moderately relativistic electron beam to interact with a fast waveguide mode near the grazing intersection of the frequency versus wavenumber plot (see Fig. 8) where the resonance line is tangent to the electromagnetic mode. This produces high gain and efficiency because the phase velocities of the two modes are nearly matched and the group velocity of the waveguide mode is nearly equal to v_z . In the gyro-TWT regime

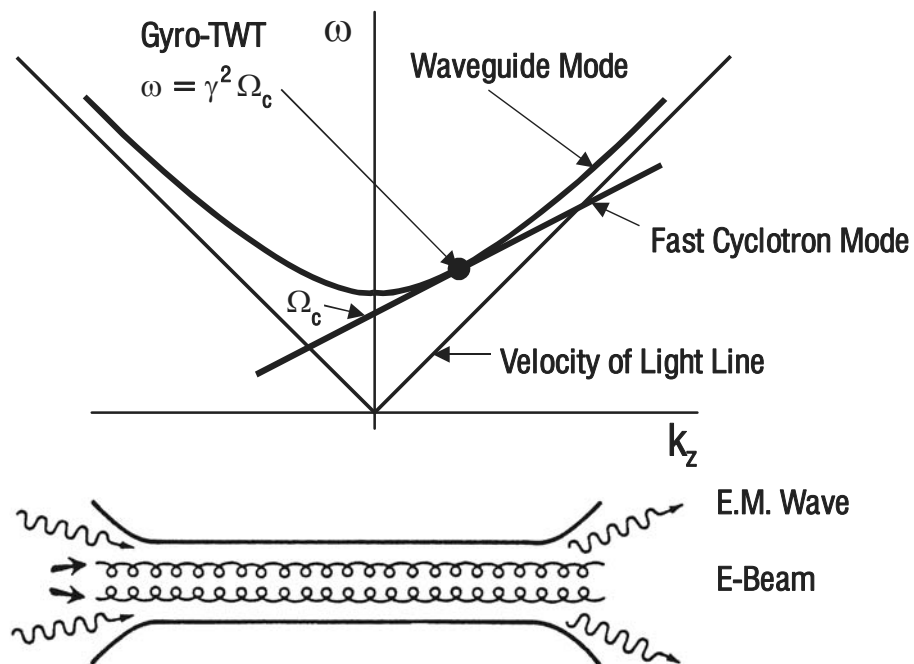

Fig. 8: Dispersion diagram and scheme of interaction circuit of Gyro-TWT amplifier.

($\omega/k_z \gg c$), the axial bunching mechanism is too weak to be of any significance. To benefit from autoresonance, the cutoff frequency should be reduced relative to the cyclotron frequency. The circuit employed in a gyro-TWT consists simply of an unloaded waveguide. Since no resonant structures are present, the gyro-TWT is potentially capable of much larger bandwidth than a gyrokystron and thus can be used as output amplifier in mm-wave radar communication systems. Advanced devices employ tapered magnetic field and interaction

circuit as well as two partially loaded stages in order to optimize the beam-wave interaction along the waveguide [271-274].

The sensitivity to velocity spread can be strongly reduced by coupling between the second harmonic cyclotron mode of a gyrating electron beam and the radiation field in the region of near infinite phase velocity over a broad bandwidth by using a cylindrical waveguide with a helical corrugation on its inner surface (coupled-modes gyro-TWT) [275,276].

The gyrotwystron [9], a hybrid device, is derived from the gyrokystron by extending the length of the drift section and replacing the output cavity with a slightly tapered waveguide section like in a gyro-TWT. The output waveguide section is excited by the beam of electrons that are bunched because of modulation in the input cavity. The gyrotwystron configuration has broader bandwidth and can mitigate the problem of microwave breakdown at high power levels, since the microwave energy density in the output waveguide can be much smaller than in an output cavity. The inverted gyrotwystron is a device consisting of the input waveguide, drift section, and output cavity [277]. The travelling signal wave in the input waveguide may induce a high harmonic content in the electron current density. Then the prebunched electron beam can excite phase-locked oscillations in the cavity at a harmonic of the signal frequency.

3.4 Gyro-BWO (Backward Wave Oscillator)

If the electron beam and/or magnetic field is adjusted so that the straight fast-wave beam line crosses the negative k_z -branch of the waveguide mode hyperbola (see Fig. 9) then an absolute instability (internal feedback) with a "backward wave" occurs. In the gyro-BWO the frequency of operation is now governed by the slope of the line, which is a function of v_z , and

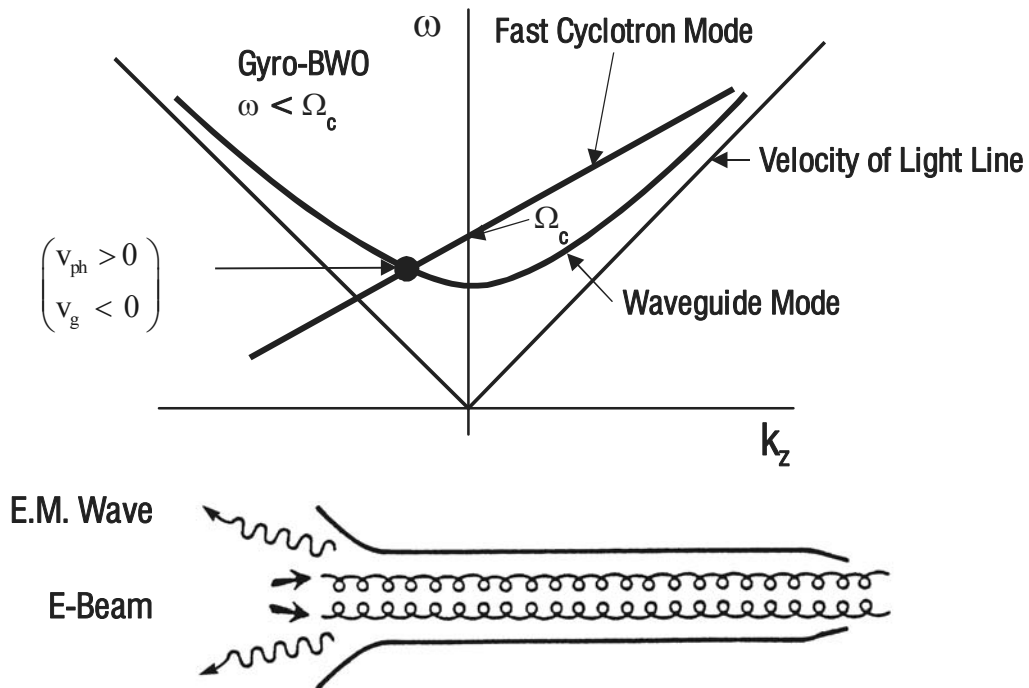

Fig. 9: Dispersion diagram and scheme of interaction circuit of Gyro-BWO.

thus of the beam acceleration voltage V_0 . Consequently, just as in the case of slow-wave BWOs (e.g. carcinotron), the frequency of oscillations can be continuously changed very fast over a broad range, using V_0 in place of B_0 . However, there is a Doppler down shift in frequency ($\Omega_c/2 < \omega < \Omega_c$), so that very high magnetic fields are required for high frequency operation.

3.5 Overview on Gyro-Devices

Bunching of electrons in the gyrotron oscillator discussed in section 3.1 has much in common with that in conventional linear electron beam devices, namely, monotron, klystron, TWT, twystron and BWO [9]. In both cases the primary energy modulation of electrons gives rise to bunching (azimuthal or longitudinal) which is inertial. The bunching continues even after the primary modulation field is switched off (at the drift sections of klystron-type and twystron-type devices). This analogy suggests the correspondence between conventional linear-beam (O-type) devices and various types of gyro-devices. Table I presents the schematic drawings of devices of both classes and the orbital efficiencies calculated using a simplified uniform approximation for the longitudinal structure of the RF field in the gyromonotron ($s=1$) [9]. For the gyroklystron, the calculation was made in the narrow-gap approximation of the RF field in the input and output cavities. The electrodynamic systems of the gyro-TWT and gyro-BWO, as well as the output section of the gyrotwystron, were assumed to have the form of a uniform waveguide. In all these cases the magnetic field is assumed to be homogeneous.







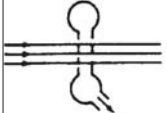
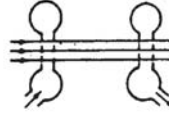

"O" TYP DEVICES	 MONOTRON	 KLYSTRON	 TWT	 TWYSTRON	 BWO
TYPE OF GYRO-DEVICE	 GYRO-MONOTRON	 GYRO-KLYSTRON	 GYRO-TWT	 GYRO-TWYSTRON	 GYRO BWO
MODEL RF-FIELD STRUCTURE					
MODEL ORBITAL EFFICIENCY	0.42	0.34	0.7	0.6	0.2

Table I: Overview of gyro-devices and comparison with corresponding conventional linear-beam (O-type) devices [9].

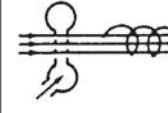
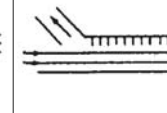
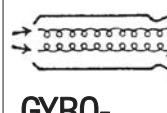
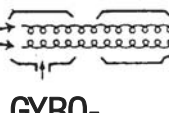
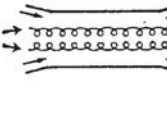
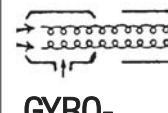
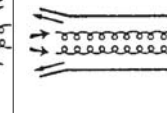
In Tables XIIIb, XVIII, XIX, XXIX and XXX we will briefly consider two other source types similar to, but also fundamentally different in one way or another from, the ECMs. The large orbit gyrotron (LOG) employs an axis-encircling electron beam in which the trajectory of each electron takes it around the axis of the cylindrical interaction region [250,278]. For the operating modes TE_{mn} a strong selection rule is valid: $m = s$ in eq. (5). Peniotron and gyropeniotron are driven by an interaction that is phased quite differently from the ECM interaction; in practice, the peniotron and ECM mechanisms compete [251-254,279].

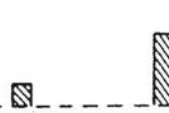
4 Magnicons and Gyroharmonic Converters

The magnicon is a member of the class of scanning-beam amplifier tubes [16,280,281]. It is a magnetized device that uses a fast-wave output cavity. Therefore, it can also be grouped with gyro-devices in which electrons gyrating in an external magnetic field emit bremsstrahlung radiation near the cyclotron resonance. In the earliest version of the magnicon, an electron beam is deflected in the unmagnetized input cavity, using a rotating TM_{110} mode and after an also unmagnetized drift space, the deflected beam is spun up to high transverse momentum by entry into a strong magnetic field at the entrance of the output cavity.

As a result of the phase-synchronous transverse deflection of the electron beam as a whole, the beam electrons entering the output cavity execute Larmor motion whose entry point and guiding center rotate in space around the cavity axis at the drive frequency. In the output cavity, the beam is used to drive a cyclotron-resonant fast-wave interaction with a synchronously rotating TM_{110} mode that extracts principally the transverse beam momentum. This interaction can be highly efficient, because the magnicon beam is fully bunched in space and in gyrophase, so that the phase bunching produced by the cyclotron maser instability is not required. With all the electrons decelerated indentially, very high efficiencies can be achieved.

Recently, higher perveance versions of the magnicon have been developed [281], in which a fully magnetized electron beam is spun up to a high transverse momentum in a sequence of deflection cavities containing synchronously rotating TM_{110} modes, the first driven by an external RF source (Fig. 10). In addition, the output cavity can operate in the m th harmonic of the drive frequency by using TM_{m10} modes with $m > 1$, permitting extension of magnicon operation to higher operating frequencies. Again the point of injection of the beam into the output cavity, as well as the entry gyrophase, rotate synchronously with a rotating RF mode of the output cavity. This makes possible much higher efficiencies than in most other gyro-devices. The key to the efficiency of these new magnicon designs is to spin the beam up to high transverse momentum ($\alpha > 1$) without producing large spreads in energy and gyrophase, so that the output cavity interaction will remain coherent over the entire ensemble of electrons, and not just synchronous in time. This requires great care in the design of the deflection cavities, in particular of the penultimate deflection cavity that produces more than half of the beam spin up. Since these spreads are generated by the fringing fields of the beam tunnel apertures in the deflection cavities and the output cavity, it also requires the use of a very small initial beam radius.

A summary of the development status of magnicons is given in Table XXXI.

A similar "scanning-beam" device is the gyroharmonic converter in which dubbed "co-generation" arises from a near match in group and phase velocities between the input cavity TE_{11} mode at frequency ω and TE_{72} mode at frequency 7ω in a cylindrical waveguide [282]. This match allows efficient power transfer into the 7th harmonic from a fundamental frequency wave that energizes an electron beam via cyclotron autoresonance acceleration (CARA). Theory indicates that high conversion efficiency can be obtained for a high quality beam injected into CARA, and when mode competition can be controlled.

Generation of 0.5 MW power (3 μ s pulse duration, 5 % efficiency) at 8.57 GHz (3rd harmonic of 2.856 GHz) in the TE_{31} mode has been observed in experiments using a 350 kV, 30 A electron beam [282-284].

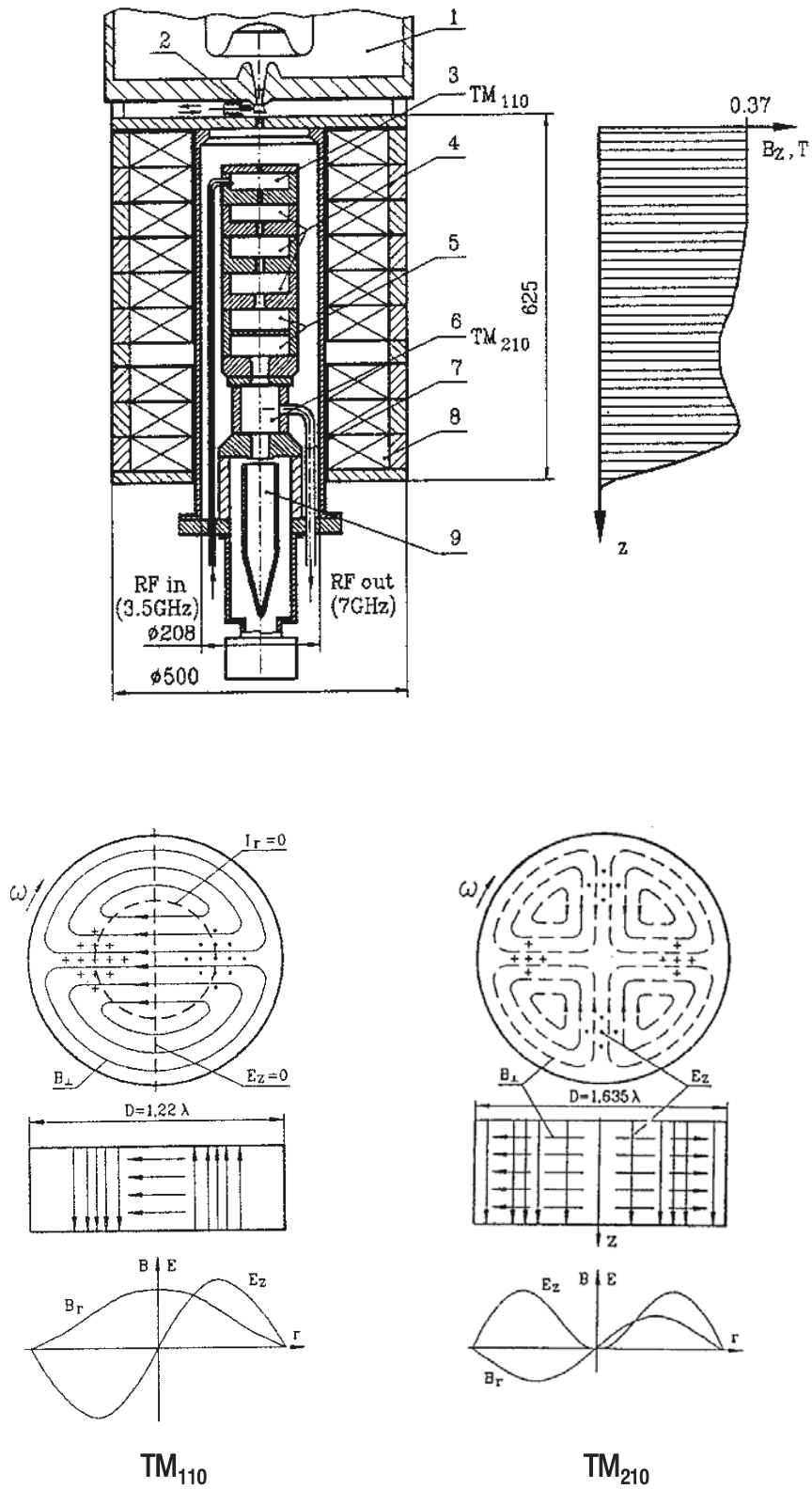

Fig. 10: Schematic layout of the magnicon: 1 – electron source; 2 – vacuum valve; 3 – drive cavity; 4 – gain cavity; 5 – penultimate cavity; 6 – output cavity; 7 – waveguide (x2); 8 – solenoid; 9 – collector [280].

5 Free Electron Masers

Free electron lasers (FELs) differ from the other high-power microwave sources considered in this report in that they have demonstrated output over a range of frequencies extending far beyond the microwave spectrum, well into the visible and ultraviolet range [236,241,251,252]. To achieve this spectral versatility, FELs exploit relativistic beam technology to upshift the electron "wobble" frequency by an amount roughly proportional to γ^2 (see Fig. 11 and Section 2). In this respect, perhaps a more descriptive name is that coined by R.M. Phillips [285]: UBITRON, for an "undulated beam interaction electron" tube. The magnetostatic wiggler is the most common, but not the sole means, for providing electron undulation. An electrostatic wiggler or the oscillatory field of a strong electromagnetic wave can also play this role. Devices with such electromagnetic wigglers are sometimes called scattrons [9,18,236]. The distinction between long wavelength free electron maser (FEM) ($\lambda \geq 0.5$ mm) and short wavelength FELs is natural because higher current and lower energy beams are typically employed in this regime and space-charge effects are more important. In particular, the dominant interaction mechanism is often coherent Raman scattering. Also, while short wavelength FELs excite optical modes, dispersion due to the beam dielectric effects and finite transverse dimensions in the drift tubes and cavities are important effects at longer wavelengths. A low power (3 W, 2 ms pulses) FEL operating at radio frequencies (FER) employing a 420 V, 0.2 A electron beam holds the world record for long wavelength ($f = 266$ MHz, $\lambda = 1.1$ m, $\lambda_w = 0.04$ m, $B_w = 0.04$ T) [286].

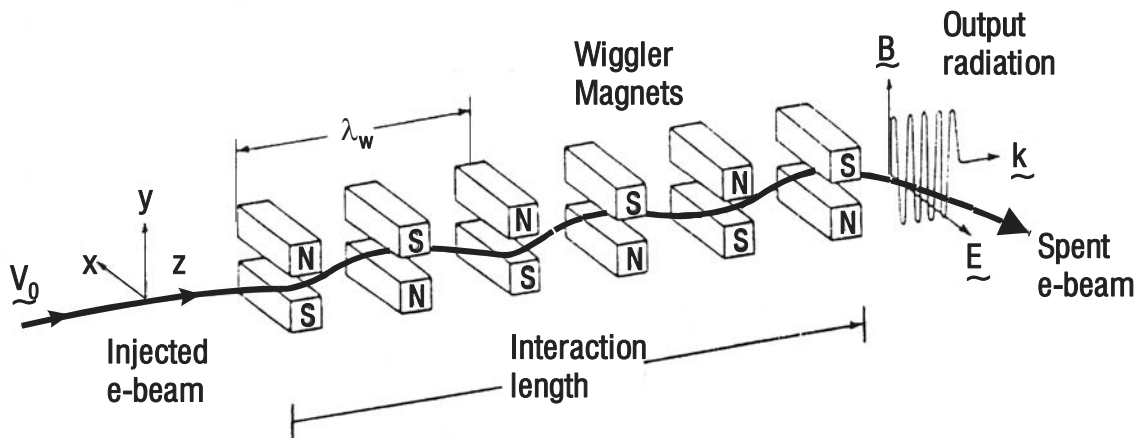

Fig. 11: The basis FEM configuration. Electrons in an injected electron beam undulate in the periodic magnetic field of the wiggler.

The FEM appears to be potentially capable of fulfilling all the requirements for a frequency tunable high-power mm-wave source. Coverage of the entire frequency range of 130-260 GHz presents no severe problems, and even higher frequencies are quite feasible [4,287-298]. Rapid tunability over more than ± 5 % could be obtained by variation of the beam energy. The interaction occurs in a cavity operating in low-order modes, which have very good coupling to a Gaussian beam output. The relatively low RF wall loading and the use of high electron beam energy (>0.5 MeV) and a multi-stage depressed collector are compatible with a high unit power at efficiencies around 50% if the electron beam interception could be maintained at an acceptable level. A survey of FEM development status (experiments) is presented in Tables XXXII and XXXIII. It is a great pity that the FOM-FEM project [287-297] was terminated in the autumn of 2001.

The highest CW power generated by a FEM is 36 W (15 Hz) [299] whereas the IR-FEL at the Thomas Jefferson National Accelerator Facility obtained a record average power of 10 kW at 1-14 μm (14.2 kW at 1.6 μm). A recirculated electron beam power of up to 1 MW (Energy Recovering Linac) has been demonstrated resulting in an overall efficiency of approximately 2% [300-306]. The average output power in the THz regime is 100 W.

The first stage of the Novosibirsk High Power Free Electron Laser (NovoFEL) had been commissioned in 2003. This THz-FEL generates coherent radiation, tunable in the range of 110-235 μm (2.73-1.28 THz), 60-117 μm and 40-80 μm at the first, second and third harmonics, respectively, with the corresponding maximum average output powers of 0.5 kW, 100 W and 30 W. The maximum peak power is 1 MW (bunch duration: 40-100 ps), the minimum relative linewidth is 0.3% [307,308].

The two-orbit energy recovery linac stage was assembled and commissioned in 2008. The first lasing of the two-stage THz-FEL was achieved in 2009, providing radiation in the wavelength range 40-80 μm at an average output power between 1 and 0.5 kW with a maximum gain of 40% [309,310].

The 200 ns Induction LINAC FEM at JINR Dubna [311] has also been operated as FEM multiplier (n=1: 72 GHz, 0.5 MW; n=2: 48 GHz, 2 MW; n=3: 72 GHz, 0.5 MW) and as 2nd harmonic FEM oscillator.

6 Gyrotron Oscillators and Microwave Vacuum Windows for Plasma Heating

Institution	Frequency [GHz]	Mode		Power [MW]	Efficiency [%]	Pulse length [s]	
		cavity	output				
ABB, Baden [254,312]	8	TE ₀₁	TE ₀₁	0.35	35	0.5	
	39	TE ₀₂	TE ₀₂	0.25	42	0.1	
ARIEL UNIV., Ariel [313]	95	TE ₀₂	TE ₀₂	0.005	12	0.0000005	
CPI ¹⁾ , Palo Alto	8	TE ₂₁	TE ₁₀	0.5 (dual output)	33	1.0	
[14,19,314-331]	28,35	TE ₀₂	TE ₀₂	0.2	37	CW	
	53.2,56,60,70	TE _{01/02}	TE ₀₂	0.23	37	CW	
	70.15	TE _{10,3}	TEM ₀₀	0.6	47 (SDC)	2.25	
	84	TE _{15,2}	TE _{15,2/4}	0.5(0.9)	28	0.1(0.001)	
	84	TE _{15,4}	TEM ₀₀	0.56	44 (SDC)	2.0	
	94.9	TE _{6,2}	TEM ₀₀	0.12	50 (SDC)	CW	
	95.3	TE _{22,6}	TEM ₀₀	1.4 (1.92)	51 (40) (SDC)	5 (0.005)	
CPI ¹⁾ , NIFS	84	TE _{15,3}	TEM ₀₀	0.5(0.4)	29	2.0(10.5)	
Palo Alto, Toki				0.1	14	CW	
[61,62,315-319,332-335]				0.59(0.25)	41(32) (SDC)	0.001(0.2)	
GYCOM, IAP	5	TE ₀₁	TE ₀₁	0.23	26	0.1	
Nizhny Novgorod	28	TE ₄₂ ,TE ₆₂	TEM ₀₀	0.5	36	0.5	
[15,78,79,92-98,336-346]	37.5	TE ₆₂	TEM ₀₀	0.5	35	0.1	
	44.8	TE _{15,1}	TE _{15,1}	1.25	35	0.0001	
	53.2	TE ₈₃	TEM ₀₀	0.5 (0.3)	40 (36)	0.1 (1.0)	
	68 (70)	TE ₉₃	TEM ₀₀	0.5 (0.68)	50 (48) (SDC)	1.0 (3.0)	
	75	TE ₉₄	TEM ₀₀	0.5	37	0.1	
	75	TE _{11,5}	TEM ₀₀	0.8	70 (SDC)	0.1	
	82.5	TE _{11,3}	TE _{11,3}	1.0(1.5)	50(36)	0.0001	
	82.7	TE _{10,4}	TEM ₀₀	0.65(0.9)	38(32)	3.0(0.3)	
				0.65(0.2)	53 (SDC)	3.0(CW)	
		84	TE _{12,5}	TEM ₀₀	0.88	54 (SDC)	3.0
				0.5 (0.2)	50 (SDC)	10 (CW)	
	HUGHES, Torrance [251]	60	TE ₀₂	TE ₀₂	0.2	35	0.1
	IAP, Nizhny Novgorod [347]	25(2Ω _c)	TE ₀₃	TE ₀₃	0.8	40 (twin e-beam)	0.0001
IECAS, Beijing [348-350]	24.1	TE ₀₁	TE ₀₁	0.15	24	0.02	
	34.3(2Ω _c)	TE _{02/03}	TE ₀₃	0.2	30	0.02	
	94	TE ₀₂	TEM ₀₀	0.015	18	0.1	
LAP/INPE, Sao Paulo [351]	24.2	TE ₁₂	TE ₁₂	0.0058	16	0.000015	
	30.4	TE ₂₂	TE ₂₂	0.0063	18.5	0.000015	
MITSUBISHI, Amagasaki	88	TE _{8,2}	TEM ₀₀	0.35	29	0.1	
KYOTO UNIV. [352]							
NEC, Kawasaki [353]	35	TE ₀₁	TE ₀₁	0.1	30	0.001	
NRL, Washington D.C. [251,354-356]	35	TE ₀₁	TE ₀₁	0.15	31	0.02	
	35	TE ₀₄ (TE _{01/04})	TE ₀₄	0.475 (0.34)	38 (54)	0.001	
	35	TE ₂₄	TE ₂₄	0.43 (0.3)	41 (63)	0.001	
	85	TE ₁₃	TE ₁₃	0.2	30	0.001	
PHILIPS ²⁾ , Hamburg [357]	70	TE ₀₂	TE ₀₂	0.14	30	CW	
SPbSTU, St. Petersburg	74.2	TE _{12,3}	TE _{12,3}	0.1	44	0.00005	
KIT ³⁾ Karlsruhe [358-365]							
THALES ED ⁴⁾ , Velizy	8	TE ₅₁	TE ₅₁	1.0	45	1.0	
[254,366]	35	TE ₀₂	TE ₀₂	0.2	43	0.15	
TSUKUBA UNIV., TOSHIBA Ibaraki, Otawara [64,367-375]	28	TE ₀₂	TE ₀₂	0.2	35.7	0.075	
		TE _{4,2}	TEM ₀₀	0.57	40	0.01	
		TE _{8,3}	TEM ₀₀	1.2 (0.54)	30 (35)	0.001(2)	
	41 (56)	TE ₀₂	TE ₀₂	0.2	31.3 (32.9)	0.1	
	70	TE ₀₂	TE ₀₂	0.025	28.4	0.001	
	77	TE _{18,6}	TEM ₀₀	1.8(1.9)	38 (SDC)	1.0(0.1)	
				1.6	40 (SDC)	1.8	
			1.2 (0.3)	38 (SDC)	10.0 (2400)		
UESTC, Chengdu [376-382]	35(3Ω _c)	TE ₅₁ /TE ₅₂	TE ₅₂	0.147	10.2	0.0001 PM, 100 kg	
	70,94(2Ω _c)	TE ₀₂ /TE ₀₃	TE ₀₃	0.1(0.12)	20(20.5)	0.0001	
	94	TE ₆₁ /TE ₆₂	TE ₆₁ /TE ₆₂	0.09	43	CW	

SDC: Single-stage Depressed Collector

¹⁾ Communications & Power Industries, formerly VARIAN, ²⁾ formerly VALVO, ³⁾ Karlsruhe Institute of Technology, formerly FZK, ⁴⁾ formerly Thomson TE

Table II: Performance parameters of gyrotron oscillators for electron cyclotron resonance heating (ECRH) (28-95 GHz) and lower hybrid current drive (5-8 GHz) in plasmas for magnetic confinement fusion studies.

Institution	Frequency [GHz]	Mode cavity	Mode output	Power [MW]	Efficiency [%]	Pulse length [s]
CPI¹⁾, Palo Alto [14,315-319,328,330,331, 383-398]	106.4(2 Ω_c)	TE _{02,03}	TE ₀₃	0.135	21	0.1
	106.4	TE _{12,2}	TE _{12,2}	0.4	30	0.1
	110	TE _{15,2}	TE _{15,2}	0.5	28	1.0
				0.3	28	2.0
	110	TE _{22,2}	TE _{22,2/4}	0.5	27	2.5
	110	TE _{22,6}	TEM ₀₀	1.28	42.3 (SDC)	0.001
				1.05	31	5.0
			0.6 (0.52)	31 (29 SDC)	10.0	
			0.106	21	CW	
KIT²⁾, Karlsruhe [80-86,399-413]	117.9	TE _{19,5}	TEM ₀₀	1.55	31	0.007
				1.55	49.5 (SDC)	0.007
	132.6	TE _{9,4}	TE _{9,4}	0.42	21	0.005
GYCOM-M, IAP Moscow, N. Novgorod [15,256,341,414-423]	110	TE _{19,5}	TEM ₀₀	1.2	40	0.0001
				1.0	65(SDC)	0.0001
				0.93	36	2.0
				0.5	35	5.0
				0.35	33	10.0
GYCOM, IAP Nizhny Novgorod [15,78,79,88-98,336-341, 424-428]	100	TE _{22,2}	TE _{22,2}	1.1	34	0.0001
	104	TE _{18,7}	TEM ₀₀	0.98	46.5 (SDC)	0.5
	105	TE _{17,6}	TEM ₀₀	0.85	50 (SDC)	10.0
	106.4	TE _{15,4}	TEM ₀₀	0.5	33	0.2
	110	TE _{15,4}	TEM ₀₀	0.5	33	1.0
	111.5	TE _{19,6}	TEM ₀₀	1.0	32	0.0001
	129	TE _{17,5}	TEM ₀₀	0.5	32	0.5
JAEA³⁾, TOSHIBA Naka, Otawara [22,429-451]	110	TE _{22,2}	TEM ₀₀	0.75	27.6	0.002
				0.61	30	0.05
				0.61	50 (SDC)	0.05
				0.42	48 (SDC)	3.3
				0.35	48 (SDC)	5.0
	110	TE _{22,6}	TEM ₀₀	1.5	45 (SDC)	4.0
				1.0	38 (SDC)	31.0
	110	TE _{22,12}	TE _{22,12}	0.7	30	0.001
	120	TE ₀₃	TE ₀₃	0.17	25	0.01
	120	TE _{12,2}	TE _{12,2}	0.46	24	0.1
				0.25	24	0.22
	120	TE _{12,2}	TEM ₀₀	0.5	24	0.1
	MITSUBISHI, Amagasaki [452,453]	120	TE _{02,03}	TE ₀₃	0.16	25
120		TE _{15,2}	TE _{15,2}	1.02	32.5	0.0002
				0.46	30	0.1
			0.25	30	0.21	
THALES ED⁴⁾, Velizy [254,366]	100	TE ₃₄	TE ₃₄	0.19	30	0.07
	110	TE ₉₃	TE ₉₃	0.42	17.5	0.002
	110	TE ₆₄	TE ₆₄	0.34	19	0.01
			0.39	19.5	0.21	
THALES ED⁴⁾, CEA,CRPP, KIT [454-464]	118	TE _{22,6}	TEM ₀₀	0.7	37	0.01
				0.53	32	5.0
				0.35	23	111.0

SDC: Single-stage Depressed Collector

¹⁾ Communications & Power Industries, formerly VARIAN, ²⁾ formerly KfK, then FZK, ³⁾ formerly JAERI

⁴⁾ formerly Thomson TE

Table III: Present development status of high frequency gyrotron oscillators for ECRH and stability control in magnetic fusion devices ($100 \text{ GHz} \leq f < 140 \text{ GHz}$, $\tau \geq 0.1 \text{ ms}$).

Institution	Frequency [GHz]	Mode cavity	Mode output	Power [MW]	Efficiency [%]	Pulse length [s]
CPI¹⁾, Palo Alto [13,19,315-319,328,330,331, 392-396,398,465-468]	140	TE _{02/03}	TE ₀₃	0.1	27	CW
	140	TE _{15,2}	TE _{15,2}	1.04(0.32)	38(31)	0.0005(3.6)
				0.2 (0.4)	31	avg. (peak)
	140.2	TE _{28,7}	TEM ₀₀	0.92	35 (SDC)	0.003
KIT²⁾, PHILIPS³⁾ [254,469] KIT²⁾, Karlsruhe [80-86,254,399-413,470-485]				0.9	33 (SDC)	1800
	170	TE _{31,8}	TEM ₀₀	0.5	25	15.0
	140.8	TE ₀₃	TE ₀₃	0.12	26	0.4
	140.2	TE _{10,4}	TE _{10,4}	0.69	28	0.005
	140.2	TE _{10,4}	TEM ₀₀	0.6(0.5)	27(32)	0.012(0.03)
				0.50	48 (SDC)	0.03
	140.5	TE _{10,4}	TEM ₀₀	0.46	51 (SDC)	0.2
	140.1	TE _{22,6}	TEM ₀₀	1.6	60 (SDC)	0.007
				2.1	53 (SDC)	0.001
		150	TE ₀₃	TE ₀₃	0.12	20
KIT²⁾, CRPP, THALES ED⁴⁾, CEA [6,7,56-60,69-72,457, 486-520] GYCOM, IAP Nizhny Novgorod [15,88-99,337-341,416-423, 428,521-552]	162.3	TE _{25,7}	TEM ₀₀	1.48	35	0.007
				1.48	50 (SDC)	0.007
	139.8	TE _{28,8}	TEM ₀₀	1.0	50 (SDC)	12
				1.0	41 (SDC)	360
				0.92	44 (SDC)	1800
	140	TE _{22,6}	TEM ₀₀	0.96	36	1.2
				0.54	36	3.0
			(dual-beam output)	0.26 (0.1)	36	10 (80)
				2x0.37	30	3.0
				2x0.3	29	5.5
			2x0.165	28	10.0	
	140	TE _{22,8}	TEM ₀₀	1.7	42	0.0001
				1.2	68 (SDC)	0.0001
	140	TE _{22,8}	TEM ₀₀	0.95	52(SDC)	10
	170	TE _{28,7}	TEM ₀₀	1.0	32.5	0.0001
	170	TE _{25,10}	TEM ₀₀	1.2	52 (SDC)	100
				0.96	55 (SDC)	1000
	170	TE _{28,12}	TEM ₀₀	1.44	41 (SDC)	0.1
				2.1	35	0.0001
GYCOM-N, IAP Nizhny Novgorod [15,78,79,336-339,345,421-424, 426,427,521,536]	140	TE _{22,6}	TEM ₀₀	0.8	32	0.8
				0.88	50.5(SDC)	1.0
				0.55	33	2.0
	140	TE _{22,10}	TEM ₀₀	0.99	47 (SDC)	0.5
	158.5	TE _{24,7}	TEM ₀₀	0.5	30	0.7
JAEA⁵⁾, TOSHIBA Naka, Otawara [22,100,435-443,449,450,553-580]	170	TE _{22,6}	TEM ₀₀	0.45	19	0.05
				0.25	32 (SDC)	0.4
	170.1	TE _{31,8}	TE _{31,8}	1.15	29	0.0004
	170	TE _{31,8}	TEM ₀₀	1.3	32	0.003
				1.2	57 (SDC)	0.003
				1.0	55 (SDC)	800
				0.8	57 (SDC)	3600
	170	TE _{31,12}	TEM ₀₀	1.56	27	0.1
	170	TE _{31,11}	TEM ₀₀	1.0	38 (SDC)	5.0
	NIFS, TSUKUBA UNIV., TOSHIBA Toki, Ibaraki, Otawara [61-64,335,374,581,582]	154	TE _{28,8}	TEM ₀₀	1.16	28.6
168	TE _{31,8}	TEM ₀₀	0.52	19	1.0	
			0.52	30 (SDC)	1.0	

SDC: Single-stage Depressed Collector

¹⁾ Communications & Power Industries, formerly VARIAN, ²⁾ formerly KfK, then FZK, ³⁾ formerly VALVO, ⁴⁾ formerly Thomson TE, ⁵⁾ formerly JAERI

Table IV: Present development status of high frequency gyrotron oscillators for ECRH and stability control in magnetic fusion devices ($f \geq 140$ GHz, $\tau \geq 0.1$ ms).

Institution	Frequency [GHz]	Mode		Power [MW]	Efficiency [%]	Corrug.Cavity	
		cavity	output			inner	outer
KIT¹⁾ Karlsruhe [6,22,25,26,69-73,480-486,502,583-605] Pulse length \leq 100 ms	137.78	TE _{27,16}	TE _{27,16}	1.03	24.3	yes	no
	139.96	TE _{28,16}	TE _{28,16}	1.17	27.2	yes	no*
			TEM ₀₀	0.95	20	yes	no
				0.95	29(SDC)	yes	no
				(dual beam output)			
	142.02	TE _{29,16}	TE _{29,16}	1.04	24.4	yes	no
	138.70	TE _{27,14}	TEM ₀₀	1.14	26.1	yes	no
	146.70	TE _{28,15}	TEM ₀₀	1.13	25.6	yes	no
	156.90	TE _{30,16}	TEM ₀₀	1.24	25.4	yes	no
	164.98	TE _{31,17}	TE _{31,17}	1.17	26.7	yes	no
			TEM ₀₀	2.2	28	yes	no
				(single-beam output)			
				1.5	30	yes	no
				1.5	48 (SDC)	yes	no
	EGYC²⁾ [606-632]	167.14	TE _{32,17}	TEM ₀₀	1.22	25.6	yes
170		TE _{34,19}	TEM ₀₀	2.2	30	yes	no
				2.05	45.6 (SDC)	yes	no
IAP, Nizhny Novgorod [13,15,338,341,633-641] Pulse length \leq 0.1 ms	45	TE _{15,1}	TE _{15,1}	1.25	43	no	no
	100	TE _{21,18}	TE _{21,18}	1.0	35	yes	no
				0.5	20	no	no
	100	TE _{25,13}	TE _{25,13}	2.1	30	no	no
				1.6	38	no	no
	103	TE _{22,13}	TE _{22,13}	1.0	40	yes	yes
				0.7	30	yes	no
				0.3	14	no	no
	110	TE _{17,7}	TE _{17,7}	0.7	25	no	no
	110	TE _{20,13}	TE _{20,13}	1.15	35	yes	no
	110	TE _{21,13}	TE _{21,13}	1.0	35	yes	no
	140	TE _{28,16}	TE _{28,16}	1.5	33.5	yes	no*
				1.15	50 (SDC)	yes	no
			1.17	35.2	yes	yes	
		TE _{76,2}	1.17	35.2	yes	yes	
		TEM ₀₀	1.1	30	yes	no	
			(dual-beam output)				
224 (2 Ω_c)	TE _{33,8}	TE _{33,8}	0.1	11	yes	no	
IAP, KIT¹⁾ Karlsruhe [583] Pulse length 30 μs	133	TE _{27,15}	TE _{27,15}	1.3	29	no	no
	140	TE _{28,16}	TE _{28,16}	1.0	23	no	no
MIT, Cambridge [642-644] Pulse length 3 μs	137	TE _{25,11}	TEM ₀₀	0.5	7.5	no	no
	139.6	TE _{26,11}	TEM ₀₀	0.9	13	no	no
	142.2	TE _{27,11}	TEM ₀₀	1.0	14.5	no	no
	140	TE _{21,13}	TEM ₀₀	0.5	7.5	no	no

¹⁾ formerly KfK, then FZK, * very similar cavity and tube design

²⁾ EGYC is a collaboration among CRPP, Switzerland; KIT, Germany; HELLAS, Greece; CNR, Italy; ENEA Italy

Table V: Present experimental development status of short pulse (3 μ s – 15 ms) coaxial cavity gyrotron oscillators.

Design studies for a 4 MW, 170 GHz coaxial-cavity gyrotron for future fusion reactors are currently being performed at KIT. The coaxial cavity operates in the TE_{52,31} mode and the q.o. output coupler generates two fundamental Gaussian beams which leave the tube through two CVD-diamond windows [645,646].

Institution	Frequency	Mode		Power	Efficiency	Pulse length
	[GHz]	cavity	output	[MW]	[%]	[s]
CPI¹⁾, Palo Alto [26,314-331,387-396,465-468]	8	TE ₂₁	TE ₁₀	0.4	26.6	0.0005
	(dual rectangular waveguide output)			0.4	34.2 (SDC)	0.0005
	70.15	TE _{10,3}	TEM ₀₀	0.6	47 (SDC)	2.25
	94.9	TE ₆₂	TEM ₀₀	0.12	50 (SDC)	CW
	95.3	TE _{22,6}	TEM ₀₀	0.62 (1.92)	41(40) (SDC)	15 (0.005)
	110	TE _{22,6}	TEM ₀₀	1.28	42.3 (SDC)	0.001
				0.52	29 (SDC)	10
	140.2	TE _{27,8}	TEM ₀₀	0.92	35(SDC)	0.003
				0.9	33(SDC)	1800
	CPI¹⁾, NIFS Palo Alto, Toki [61-64,318]	84	TE _{15,3}	TEM ₀₀	0.5	29
			0.59	41 (SDC)	0.001	
			0.25	32 (SDC)	0.2	
KIT²⁾, Karlsruhe [23,80-86,399-413,475-486]	117.9	TE _{19,5}	TEM ₀₀	1.55	49.5 (SDC)	0.007
	140.2	TE _{10,4}	TEM ₀₀	0.50	48 (SDC)	0.03
	140.5	TE _{10,4}	TEM ₀₀	0.46	51 (SDC)	0.2
	140.1	TE _{22,6}	TEM ₀₀	1.6	60 (SDC)	0.007
				2.1	53 (SDC)	0.001
KIT²⁾, CRPP, THALES ED³⁾, CEA [6,26,56-59,69-72,457,486- 520]	162.3	TE _{25,7}	TEM ₀₀	1.48	50 (SDC)	0.007
	139.8	TE _{28,8}	TEM ₀₀	1.0	50 (SDC)	12
				0.92	43 (SDC)	1800
GYCOM, IAP	68 (70)	TE _{9,3}	TEM ₀₀	0.5 (0.68)	50 (48) (SDC)	1.0 (3.0)
Nizhny Novgorod [339-341,343-346,417,418, 423,425]	75	TE _{11,5}	TEM ₀₀	0.8	70 (SDC)	0.1
	82.7	TE _{10,4}	TEM ₀₀	0.65	38	3.0
				0.65	53 (SDC)	0.03
				0.2	52 (SDC)	CW
	84	TE _{12,5}	TEM ₀₀	0.88 (0.2)	50 (SDC)	3.0 (CW)
	104	TE _{18,7}	TEM ₀₀	0.98	46.5 (SDC)	0.5
	110	TE _{19,5}	TEM ₀₀	1.0	65 (SDC)	0.0001
	140	TE _{22,6}	TEM ₀₀	0.8	32	0.8
				0.88	50.5 (SDC)	1.0
				0.99	47 (SDC)	0.5
GYCOM, IAP	140	TE _{22,10}	TEM ₀₀	1.7	42	0.0001
Nizhny Novgorod [26,88-99,345,534-552]	140	TE _{22,8}	TEM ₀₀	0.95	52(SDC)	10
	170	TE _{25,10}	TEM ₀₀	1.2	52 (SDC)	100
				0.96	55 (SDC)	1000
	170	TE _{28,12}	TEM ₀₀	1.44	41 (SDC)	0.1
	115	QOG	TEM ₀₀	0.43	12.7 (SDC)	10 ⁻⁵
NRL, Washington D.C. [647]			0.20	16.1 (SDC)	10 ⁻⁵	
JAEA⁴⁾, TOSHIBA Naka, Otawara [429-451,553-580]	110	TE _{22,2}	TEM ₀₀	0.61	50 (SDC)	0.05
				0.35	48 (SDC)	5.0
	110	TE _{22,6}	TEM ₀₀	1.5	45 (SDC)	4.0
				1.0	38 (SDC)	31.0
	170	TE _{22,6}	TEM ₀₀	0.25	19	0.4
				0.25	32 (SDC)	0.4
	170.2	TE _{31,8}	TEM ₀₀	1.2	57 (SDC)	0.003
				1.0	55 (SDC)	800
				0.8	57 (SDC)	3600
				1.0	47 (SDC)	5.0
NIFS, TOSHIBA	77	TE _{18,6}	TEM ₀₀	1.2 (0.3)	38 (SDC)	10.0 (2400)
Toki, Otawara [61-64,335, 369-375,581,582]	168	TE _{31,8}	TEM ₀₀	0.52	19	1.0
			0.52	30 (SDC)	1.0	

SDC: Single-stage Depressed Collector;

QOG: Quasi-Optical Gyrotron

¹⁾ formerly VARIAN, ²⁾ formerly KfK, then FZK, ³⁾ formerly Thomson TE ⁴⁾ formerly JAERITable VI: Present development status of high frequency gyrotron oscillators with conventional cylindrical or quasi-optical cavity and single-stage depressed collector (SDC) ($\tau \geq 10 \mu\text{s}$).

Institution	Frequency [GHz]	Mode cavity	output	Power [MW]	Efficiency [%]	Pulse length [s]	
KIT¹⁾, Karlsruhe [26,80-87,404, 407-413,481-486, 513-515]	114.2	TE _{18,5}	TEM ₀₀	0.85	23	0.001	
	117.9	TE _{19,5}	TEM ₀₀	1.0	27	0.001	
				1.55	49.5 (SDC)	0.007	optimized
	121.6(119.5)	TE _{20,5} (TE _{19,7})	TEM ₀₀	1.0(0.88)	27(23)	0.001	
	125.3(124.1)	TE _{21,5} (TE _{20,7})	TEM ₀₀	1.0(0.89)	27(24)	0.001	
	128.9	TE _{22,5}	TEM ₀₀	0.9	24.5	0.001	
	132.6(130.9)	TE _{20,6} (TE _{22,7})	TEM ₀₀	0.85(0.9)	23(24)	0.001	
	136.2	TE _{21,6}	TEM ₀₀	0.9	24.5	0.001	
	140.1(140.0)	TE _{22,6} (TE _{22,8})	TEM ₀₀	1.0(1.2)	27(28)	0.001	
				1.6	60 (SDC)	0.007	optimized
	143.7(143.3)	TE _{23,6} (TE _{23,8})	TEM ₀₀	1.1(1.2)	30(29)	0.001	
	147.4	TE _{24,6}	TEM ₀₀	1.1	30	0.001	
	151.2	TE _{25,6}	TEM ₀₀	1.05	28.5	0.001	
	154.9(155.9)	TE _{23,7} (TE _{24,9})	TEM ₀₀	0.95(0.98)	26(26)	0.001	
	158.5(159.2)	TE _{24,7} (TE _{25,9})	TEM ₀₀	1.1(1.0)	30(27.2)	0.001	
	162.3(162.5)	TE _{25,7} (TE _{26,9})	TEM ₀₀	1.0(0.99)	27(27.3)	0.001	
				1.48	50 (SDC)	0.007	optimized
		166.0(165.9)	TE _{26,7} (TE _{27,9})	TEM ₀₀	1.0(0.95)	26(26)	0.001
GYCOM, IAP Nizhny Novgorod [26,39-43,78,79,88- 99,341-345,423, 426-428,543,544, 648]	71.5	TE _{10,5}	TEM ₀₀	0.8	56	0.15	3f-Gyrotron with Brewster wind.
	74.8	TE _{11,5}	TEM ₀₀	0.8	56	0.15	
	78.1	TE _{12,5}	TEM ₀₀	0.8	56	0.15	
	121.5	TE _{20,5}	TEM ₀₀	0.5	30	0.0001	
	140.0	TE _{22,6}	TEM ₀₀	0.5	30	0.5	
	158.5	TE _{24,7}	TEM ₀₀	0.5	30	0.7	
	105.1	TE _{17,6}	TEM ₀₀	1.24	41.2	0.0001	
				0.85	50 (SDC)	10	
	111.7	TE _{19,6}	TEM ₀₀	1.37 (0.8)	42.9 (30)	0.0001(0.1)	
	124.3	TE _{20,7}	TEM ₀₀	1.18	37.0	0.0001	
				0.85	29	10	
	127.6	TE _{21,7}	TEM ₀₀	1.33	41.6	0.0001	
	140.1	TE _{22,8}	TEM ₀₀	1.42 (1.7)	43.3 (42)	0.0001	
				1.2	68 (SDC)	0.0001	
				0.95	52 (SDC)	10	
	152.6	TE _{23,9}	TEM ₀₀	1.44	44.2	0.0001	
	156.0	TE _{24,9}	TEM ₀₀	1.01	36.1	0.0001	
	104	TE _{18,7}	TEM ₀₀	0.98	46.5 (SDC)	0.5	
140	TE _{22,10}	TEM ₀₀	0.99	47 (SDC)	0.5		
JAEA²⁾, TOSHIBA Naka, Otawara [100,574,577,579, 580]	136.8	TE _{25,9}	TEM ₀₀	1.30	26	0.0005	2f-Gyrotron
				0.54	42 (SDC)	20	
	170	TE _{31,11}	TEM ₀₀	1.30	27	0.0005	
				0.91	45 (SDC)	75	
	166.7	TE _{30,8}	TEM ₀₀	0.54	27	0.001	
	170	TE _{31,8}	TEM ₀₀	0.62	32	0.001	
TSUKUBA UNIV., TOSHIBA, Ibaraki Otagawa [451]	110.1	TE _{22,8}	TEM ₀₀	1.12	32	0.1	
	137.6	TE _{27,10}	TEM ₀₀	0.49	29	0.02	
MIT, Cambridge [649-656]	107.1	TE _{21,6}	TEM ₀₀	1.1	30	0.000003	3f-Gyrotron
	110.1	TE _{22,6}	TEM ₀₀	1.4	37	0.000003	
	113.0	TE _{23,6}	TEM ₀₀	1.1	30	0.000003	

SDC: Single-stage Depressed Collector; ¹⁾ formerly KfK, then FZK, ²⁾ formerly JAERI

Table VII: Step-tunable conventional cavity 1 MW gyrotron with broadband Quartz Brewster window at KIT ($U_c = 82$ kV, $I_b = 45$ A). Pulse length up to 7 ms with Silicon Nitride (Kyocera SN-287) Brewster window. Two and three-frequency and multi-frequency GYCOM gyrotrons with matched plane BN or CVD-diamond windows. The 140 GHz TE_{22,10}-mode tube was also operated in 50-150 ms pulses with a BN Brewster window (11 frequencies at 0.8 MW between 104 and 143 GHz). Two-frequency JAEA and TSUKUBA/TOSHIBA and three-frequency MIT gyrotrons.

The KIT 1 MW TE_{22,6} gyrotron operated at frequencies between 114 and 166 GHz has been investigated with respect to fast-frequency tunability in the frequency range from 132.6 to 147.4 GHz [86]. For that purpose, the gyrotron has been equipped with a special hybrid-magnet system consisting of superconducting (sc) magnets in the cryostat and additional normalconducting (nc) copper magnets with a fast time constant. Special problems due to the magnetic coupling between the different magnets were investigated by calculation and experiment. Making use of these investigations different current regulation schemes for the nc magnets were implemented and tested experimentally. Finally a step-tuning operation between the modes from TE_{20,6} to TE_{24,6} in time steps of 1 s has been achieved.

Institution	Frequency [GHz]	Mode cavity	Mode output	Power [MW]	Efficiency [%]	Pulse length [s]
KIT ¹⁾ , Karlsruhe [85,584-597,599-601]	136.3	TE _{26,14}	TEM ₀₀	1.02	23.5	0.001
	138.7	TE _{27,14}	TEM ₀₀	1.14	26.1	0.001
	140.8	TE _{28,14}	TEM ₀₀	0.92	24.0	0.001
	142.2	TE _{26,15}	TEM ₀₀	0.90	20.6	0.001
	144.4	TE _{27,15}	TEM ₀₀	0.96	23.1	0.001
	146.7	TE _{28,15}	TEM ₀₀	1.13	25.6	0.001
	149.0	TE _{29,15}	TEM ₀₀	1.08	22.9	0.001
	151.1	TE _{30,15}	TEM ₀₀	1.00	21.3	0.001
	152.4	TE _{28,16}	TEM ₀₀	0.75	20.8	0.001
	154.6	TE _{29,16}	TEM ₀₀	0.94	23.4	0.001
	156.9	TE _{30,16}	TEM ₀₀	1.24	25.4	0.001
	159.2	TE _{31,16}	TEM ₀₀	1.04	23.9	0.001
	160.7	TE _{29,17}	TEM ₀₀	0.99	20.7	0.001
	162.8	TE _{30,17}	TEM ₀₀	0.98	20.7	0.001
	165.1	TE _{31,17}	TEM ₀₀	1.24	26.3	0.001
	EGYC ²⁾ [625-629]	167.2	TE _{32,17}	TEM ₀₀	1.22	41 (SDC) 25.6
141.3		TE _{28,16}	TEM ₀₀	1.8	26	0.001
170.0		TE _{34,19}	TEM ₀₀	2.2	30	0.001

SDC: Single-stage Depressed Collector;

¹⁾ formerly KfK, then FZK,

²⁾ EGYC is a collaboration among CRPP, Switzerland; KIT, Germany; HELLAS, Greece; CNR, Italy; ENEA Italy

Table VIII: Step-tunable 1 MW and 2 MW gyrotrons with coaxial cavity (tapered and longitudinally corrugated inner rod) and broadband Silicon Nitride (Kyocera SN-287) Brewster window.

A specific feature of the coaxial gyrotron design is that it allows electron beam energy recovery and very fast frequency tuning by biasing the coaxial insert [638-641]. By biasing the inner rod of the KIT coaxial cavity gyrotron, such very fast (within ≈ 0.1 ms) frequency tuning has been demonstrated at a power level of 1 MW. In particular, step frequency tuning between the 165.1 GHz nominal mode and its azimuthal neighbors at 162.8 GHz and 167.2 GHz (see Table VIII) has been performed. In addition, operating in the nominal mode TE_{31,17} a continuous frequency pulling within the bandwidth of up to 70 MHz has been performed [601].

Material	Type	Power (kW)	Frequency (GHz)	Pulse Length (s)	Institution
water-free fused silica	single-disk inertially cooled	200	60	5.0	UKAEA/Culham
boron nitride	single-disk water edge cooled	930	110	2.0	GYCOM-M
		350	110	10	GYCOM-M
		960	140	1.2	GYCOM-M
		550	140	3.0	GYCOM-M
		100	140	80	GYCOM-M
		1030	170	1.0	GYCOM-M
		500	170	5.0	GYCOM-M
		270	170	10	GYCOM-M
silicon nitride	single-disk gas face and water edge cooled	130	84	30.0	NIFS/CPI
		520	168	1.0	NIFS/TOSHIBA
sapphire	single-disk LN ₂ edge cooled	530	118	5.0	CEA/CRPP/FZK/TED
		350	118	100	CEA/CRPP/FZK/TED
		285*	140	3.0	IAP/INFK
		500	140	0.5	KIT/IAP/IPF/IPP
		370	140	1.3	KIT/IAP/IPF/IPP
sapphire	single-disk LHe edge cooled	410	110	1.0	JAEA/TOSHIBA
		500	110	0.5	JAEA/GA
sapphire	double-disk FC75 face cooled	200	60	CW	CPI
		400	84	10.5	NIFS/CPI
		350	110	5.0	JAEA/TOSHIBA
		200	140	CW	CPI
sapphire	distributed water cooled	65**	110	0.3	GA/JAEA
		200*	110	0.7	GA/CPI
Au-doped silicon	single-disk CO ₂ gas edge cooled	600	140	0.8	GYCOM-M
diamond	single-disk water edge cooled	600	70	2.3	CPI
		1.2	77	10	NIFS/TOHOKU/TOSHIBA
		0.3	77	2400	NIFS/TOHOKU/TOSHIBA
		500	84	2.0	CPI
		300**	110	1.0	CPI/FOM
		50	110	CW	CPI/FOM
		450	110	2.0	GYCOM-M/GA
		1050	110	5.0	CPI/GA
		600	110	10	CPI/GA
		1500	110	4.0	JAEA/TOSHIBA
		1000	110	31	JAEA/TOSHIBA
		340	118	50	KIT/CEA/TED
		300	118	111	KIT/CEA/TED
		1000	140	12	KIT/CEA/CRPP/TED
		920	140	1800	KIT/CEA/CRPP/TED
		900	140	1800	CPI
		1200	170	100	CYCOM
		960	170	1000	GYCOM
1000	170	800	JAEA/TOSHIBA		
800	170	3600	JAEA/TOSHIBA		

Note: * and ** indicates that the power corresponds to that of a 1 MW (*) and 0.8 MW (**)HE₁₁ mode, respectively.

Tab. IX: Experimental parameters of high-power millimeter-wave vacuum windows [15,19,22,26,67,92-99,253-255,316-331,335,341,345,346,370-375,383-468,487-520,522-582,648,657-703].

Material	BeO p.c.	BN (CVD) p.c.	Si ₃ N ₄ composite (SN-287)	Sapphire (Al ₂ O ₃) s.c. orientation of E c ⊥ \vec{E}	Silicon Au-doped s.c.	Diamond (PACVD) p.c.	Si C (6 H) p.c.
Thermal Conductivity k [W/mK]	260	55	59	40	150	2000	330
Ultimate Bending Strength σ_B [MPa]	140	80	800	410	1000	500	440
Poissons Number ν	0.3	0.25	0.28	0.22	0.1	0.1	0.18
Density ρ [g/cm ³]	2.85	2.3	3.4	4.0	2.3	3.515	3.2
Specific Heat Capacity c_p [J/g K]	1.05	0.8	0.6	0.8	0.7	0.502	0.38
Young's Modulus E [GPa]	345	70	320	385	190	1050	700
Therm. Expans. Coeff. α [10 ⁻⁶ /K]	7.2	3	2.4	5.5	2.5	1.0	4.3
Permittivity (145 GHz) ϵ_r'	6.7	4.7	7.84	9.4	11.7	5.67	9.92
Loss Tangent (145 GHz) $\tan\delta$ [10 ⁻⁵]	70	115	30	20	0.35	2	7
Metallizing/Brazing Bakeout	o.k.	o.k.	o.k. 550°C	o.k. 550°C	o.k. 550°C	o.k. 450°C	o.k. 550°C
Possible Size \varnothing [mm]	150	145	300	270	127	120	
Cost	medium	medium	high	high	low	very high	medium
Failure Resistance R' $R' = k\sigma_B(1-\nu)/E\alpha$	10.3	15.7	44.5	6.0	284	858	40
RF-Power Capacity P _T $P_T = R'\rho c_p / ((1 + \epsilon_r')\tan\delta)$	0.06	0.05	0.36	0.09	106	118	0.63
Radiation Sensitivity $n(10^{20}-10^{21}n/m^2)$ γ/X (0.75 Gy/s)				no no	no no	no no	

Tab. X: Thermophysical, mechanical and dielectrical parameters of window materials related to thermal load –failure resistance and power transmission capacity of edge-cooled windows at room temperature (p.c.=poly-crystalline, s.c.=single-crystalline) [67,74,678,684,688,691,704-709].

Material	Sapphire (Al ₂ O ₃) s.c. orientation of E c ⊥ \vec{E}	Silicon Au-doped s.c.	Diamond (PACVD) p.c.
Thermal Conductivity k [W/mK]	900 (20000)	1300	10000
Ultimate Bending Strength σ_B [MPa]	410	1000	500
Poissons Number ν	0.22	0.1	0.1
Density ρ [g/cm ³]	4.0	2.3	3.52
Specific Heat Capacity c_p [J/g K]	0.8	0.7	0.52
Young's Modulus E [GPa]	402 (405)	190	1050
Therm. Expans. Coeff. α [10 ⁻⁶ /K]	5.5	2.5	1.2
Permittivity (145 GHz) ϵ_r'	9.3	11.5	5.67
Loss Tangent (145 GHz) $\tan\delta$ [10 ⁻⁵]	0.57 (0.2)	0.35	2
Metallizing/Brazing Bakeout	o.k. 550°C	o.k. 550°C	o.k. 450°C
Possible Size \varnothing [mm]	270	127	160
Cost	high	low	very high
Failure Resistance R' $R' = k\sigma_B(1-\nu)/E\alpha$	130 (2871)	2463	3571
RF-Power Capacity P _T $P_T = R'\rho c_p/((1+\epsilon_r')\tan\delta)$	71 (4460)	907	490
Radiation Sensitivity $n(0.3 \cdot 10^{21} \text{ n/m}^2)$ $\gamma/X (0.75 \text{ Gy/s})$	no no	no no	no no

Tab. XI: Thermophysical, mechanical and dielectrical parameters of window materials related to thermal load –failure resistance and power transmission capacity of edge-cooled windows at LN₂-temperature – 77 K (LNe-Temperature – 30 K) (p.c. =poly-crystalline, s.c. =single-crystalline) [678].

In order to define the appropriate concepts for the development of 1 MW, CW mm-wave windows one has to compare the thermophysical, mechanical and dielectrical parameters of possible window materials related to the load-failure resistance R' and the power-transmission capacity P_T at different temperatures [65-69,74,678]. The features of beryllia, boron nitride, silicon nitride (Kyocera SN-287), sapphire, Au-doped silicon, CVD diamond and silicon carbide at room temperature and of sapphire, Au-doped silicon and CVD diamond at cryo-temperatures are summarized in Tables X and XI, where

$$R' = k \cdot \sigma_B \cdot (1-\nu)/E \cdot \alpha \quad (7)$$

and

$$P_T = R' \rho \cdot c_p \cdot ((1 + \varepsilon'_r) \tan \delta). \quad (8)$$

For a 1 MW, CW mm-wave window the parameters R' and P_T should exceed 250 and 100, respectively.

Comparison of R' and P_T for the 4 materials BeO, BN, Si₃N₄ and sapphire shows that there is no chance to use these dielectrics for edge-cooled, single-disk CW windows at room temperatures. Experiments at CPI in the US and at NIFS and JAEA in Japan confirmed, that even a double disk FC75-face-cooled sapphire window has a CW-power limit of 0.3-0.4 MW. Nevertheless these materials are widely used at lower frequencies and pulsed operation.

At LN₂-temperature 77 K (LNe-temperature 30 K) sapphire has a thermal conductivity of 900 (20000) W/mK and a loss tangent of $5.7 \cdot 10^{-6}$ ($2 \cdot 10^{-6}$) leading to $R' = 130$ (2870) and $P_T = 70$ (4460). The LN₂-edge-cooled sapphire window of the 118 GHz TED gyrotron (0.5 MW, 210 s) [454-464] operates close to the allowable lower limits of R' and P_T . However, the mechanical features and the required cooling auxiliaries make such cryo-windows very complicated. Au-doped silicon at temperatures somewhat lower than 0°C could avoid a thermal runaway and transmit 1 MW, CW but this material is too brittle and tends to mechanical cracking [666].

Using the available material parameters and employing various beam profiles, finite element computations revealed the options for 170 GHz, 1 MW, CW operation given in Table XII [65-69,74,678]. The diamond options 2 and 3 being water cooled, are preferred for their simplicity, in particular for use as torus window.

	Material	Type	RF-Profile	Cross-Section	Cooling
①	Sapphire/Metal	distributed	flattened Gaussian	rectangular (100 mm x 100 mm)	internally water cooled (300 K) $\tan \delta = 2.5 \cdot 10^{-4}$, $k = 40$ W/mK
②	Diamond	single-disk	Gaussian	circular (Ø = 80 mm)	water edge cooled (300 K) $\tan \delta = 2 \cdot 10^{-5}$, $k = 1900$ W/mK
③	Diamond	single-disk Brewster	Gaussian	elliptical (152 mm x 63.5 mm)	water edge cooled (300 K) $\tan \delta = 2 \cdot 10^{-5}$, $k = 1900$ W/mK
④	Silicon Au-doped	single-disk	Gaussian	circular (Ø = 80 mm)	edge cooled (230 K), refrigerator $\tan \delta = 2.5 \cdot 10^{-6}$, $k = 300$ W/mK
⑤	Silicon Au-doped	single-disk	Gaussian	circular (Ø = 80 mm)	LN ₂ edge cooled (77 K) $\tan \delta = 4 \cdot 10^{-6}$, $k = 1500$ W/mK
⑥	Sapphire	single disk	flattened Gaussian	elliptical (285 mm x 35 mm)	LN ₂ edge cooled (77 K) $\tan \delta = 6.7 \cdot 10^{-6}$, $k = 1000$ W/mK
⑦	Sapphire	single disk	Gaussian	circular (Ø = 80 mm)	LNe or LHe edge cooled (27 K) $\tan \delta = 1.9 \cdot 10^{-6}$, $k = 2000$ W/mK

Note that the power capability of options ②,③,⑤ and ⑦ is even 2 MW.

Table XII: Options for 1 MW, CW, 170 GHz gyrotron windows [65-69,74,678].

7 Harmonic and Very High Frequency Gyrotron Oscillators

Institution	Frequency [GHz]	Mode	Power [kW]	Efficiency [%]	Pulse length [ms]
CPI ¹⁾ , Palo Alto [710]	250	TE _{11,1} /TE _{11,2}	10	3.4	0.1
IAP, N. Novgorod [111,112,711]	157	TE ₀₃	2.4	9.5	CW
	250	TE ₀₂	4.3	18	CW
	250	TE ₆₅	1	5	CW
	326	TE ₂₃	1.5	6.2	CW
MIT, Cambridge [712,713]	209	TE ₉₂	15	3.5	0.001
	241	TE _{11,2}	25	6.5	0.001
	302	TE ₃₄	4	1.5	0.0015
	339	TE _{10,2}	4	3	0.0015
	363	TE _{11,2}	7	2.5	0.0015
	417	TE _{10,3}	15	6	0.0015
	457	TE _{15,2}	7	2	0.0015
	467	TE _{12,3}	22	3.5	0.0015
503	TE _{17,2}	10	5.5	0.0015	
UESTC, Chengdu [714]	423	TE ₂₆	4.4	2.8	0.005
UNIVERSITY, Fukui [122-135,137-142,715-727]	350.3	TE ₆₅	52	8.3	0.003
	384 ^{*)}	TE ₂₆	3	3.7	1
	388.2	TE ₁₈	62	158.0	0.003
	388.8	TE _{17,2}	83	13.8	0.003
	392.6	TE ₈₅	60	9.6	0.004
	402 ^{*)}	TE ₅₅	2	3	1
	576 ^{*)}	TE ₂₆	1	2.5	0.5
	874 ^{*)}	TE ₁₉	0.6	2.0	0.5

¹⁾ Communications & Power Industries; formerly VARIAN ^{*)} In collaboration with TOSHIBA, Ottawa

Table XIII a: Performance parameters of mm- and submillimeter-wave gyrotrons operating at the 2nd harmonic of the electron cyclotron frequency, with output power ≥ 1 kW.

Institution	Frequency [GHz]	Mode	Harmonic No. s	Power [kW]	Efficiency [%]	Pulse length [ms]
UNIVERSITY, Fukui	84.9	TE ₃₁	3	2.5	6.3	1
IAP, N. Novgorod [728-733]	89.3	TE ₃₁	3	1.7	3.3	1
	112.7	TE ₄₁	4	0.47	1	1
	138.0	TE ₅₁	5	0.1	0.2	1
IAP, N. Novgorod [117-210,734]	550	TE ₂₄	2	0.6	2.2	0.01
	680	TE ₂₅	2	1.8	3.5	0.01
	870	TE ₃₆	3	0.3	0.9	0.01
	1000	TE ₃₇	3	0.4	0.7	0.01

Table XIII b: Operation results of high harmonic gyrotrons with axis-encircling electron beam (LOG) and permanent magnet (Nd Fe B) at University of Fukui and pulsed magnet at IAP (THz gyrotron).

Institution	Frequency [GHz]	Mode	Power [MW]	Efficiency [%]	Pulse length [μ s]	
IAP, Nizhny Novgorod [111-117,119-121]	250	TE _{20,2}	0.3	31	30 - 80	pulsed magnetic field
	304	TE _{22,8}	0.3	25	25	
	330		0.13	17	30 - 80	
	430		0.12	8	30 - 80	
	500	TE _{28,3}	0.1	8.2	30 - 80	
	540		0.06	6	30 - 80	
	600	TE _{38,2}	0.053	5	30 - 80	
	650		0.04	4	40	
	670	TE _{31,8}	0.21	20	20	
	1002	TE _{6,8}	0.0018	2.4	40	
	1024	TE _{17,4}	0.005	6.1	40	
	1300	TE _{24,4}	0.0005	0.6	40	
	MIT, Cambridge [77,643,649-656, 735-746]	107.1	TE _{21,6}	0.94	24	
110		TE _{22,6}	1.67	42	3	
		TEM ₀₀	1.5	48 (SDC)	3	
113.2		TE _{23,6}	1.18	30	3	
140		TE ₀₄	0.025	7.4	3	
140		TE _{15,2}	1.33	40	3	
148		TE _{16,2}	1.3	39	3	
166.6		TE _{27,8}	1.50	34	3	
170.0		TE _{28,8}	1.50	35	3	
173.4		TE _{29,8}	0.72	29	3	
188		TE _{18,3}	0.6		3	
225		TE _{23,3}	0.37		3	
231		TE _{38,5}	1.2	20	3	
236		TE _{21,4}	0.4		3	
267		TE _{28,4}	0.2		3	
280		TE _{25,13}	0.78	17	3	
287		TE _{22,5}	0.537	19	3	
320		TE _{29,5}	0.4	20	3	
327		TE _{27,6}	0.375	13	3	
UESTC, Chengdu [747]		216	TE ₂₃	0.02	14.0	4
	221	TE ₀₃	0.02	8.5	4	
UNIVERSITY, Fukui [136,140,143,144, 716,717]	202.9	TE ₃₃	0.001	10	10000	
	278	TE ₃₃	0.001	5	1000	
	290	TE ₆₂	0.001	4	1000	
	294	TE _{14,2}	0.0018	22	10	TEM ₀₀ output mode
	314	TE ₄₃	0.001	4	1000	

Table XIV: Performance parameters of pulsed millimeter- and submillimeter- wave gyrotron oscillators operating at the fundamental electron cyclotron resonance.

Operating at the fundamental, the 2nd harmonic or the 3rd harmonic of the electron cyclotron frequency enables the gyrotron to act as a medium power (several 1-100 W) step tunable, mm- and sub-mm wave source in the frequency range from 38 GHz (fundamental) to 1.014 THz (TE_{4,12} mode, 2nd harmonic, 1 ms) [122-196,711-755].

A 30 W two-cavity gyrotron with frequency multiplication achieved at IAP an efficiency of 0.43%. The first cavity operated in the TE₀₁ mode near the fundamental cyclotron frequency at 95 GHz, the output cavity operated at the 3rd harmonic 285 GHz in the TE₀₃ mode [756-760]. Simultaneous generation at the 2nd (37.5 GHz) and 4th (75 GHz) harmonic (140 W at 60 kV and 6A) was obtained by a self-excited gyromultiplier with single, sectioned cavity [761,762].

Institution	Frequency [GHz]	Mode	Voltage [kV]	Current [A]	Power [MW]	Efficiency [%]	
MIT, Cambridge [736]	187.7	TE _{32,4}	94	57	0.65	12	
	201.6	TE _{35,4}	97	54	0.92	18	
	209.5	TE _{33,5}	98	37	0.54	15	
	213.9	TE _{34,5}	95	51	0.89	18	
	218.4	TE _{35,5}	90	44	0.56	14	
	224.3	TE _{33,6}	91	60	0.90	17	
	228.8	TE _{34,6}	92	59	0.97	18	
				100	59	1.2	20
	265.7	TE _{39,7}	90	57	0.64	12	
	283.7	TE _{43,7}	92	35	0.33	10	
	291.6	TE _{41,8}	93	54	0.887	18	

Table XV: Step tuning of MIT gyrotron oscillator (with large MIG [736]) operating at the fundamental electron cyclotron resonance frequency (pulse length 1.5 μ s).

Institution	Frequency [GHz]	Mode	Voltage [kV]	Current [A]	Power [MW]	Efficiency [%]
MIT, Cambridge [736]	249.6	TE _{24,11}	71	41	0.39	14
	257.5	TE _{23,12}	87	41	0.33	9
	267.5	TE _{25,12}	85	33	0.35	12
	277.2	TE _{27,12}	78	42	0.45	14
	280.1	TE _{25,13}	92	51	0.78	17
	285.2	TE _{26,13}	93	41	0.42	11
	282.8	TE _{23,14}	94	39	0.54	15
	287.9	TE _{24,14}	94	51	0.64	14
	292.9	TE _{25,14}	95	41	0.72	18
	302.7	TE _{27,14}	96	43	0.27	7

Table XVI: Step tuning of MIT gyrotron oscillator (with small MIG [736]) operating at the fundamental electron cyclotron resonance frequency (pulse length 1.5 μ s).

8 Gyrotrons for Technological Applications

Institution	Frequency [GHz]	Mode cavity	Mode output	Power [kW]	Efficiency [%]	Voltage [kV]	Magnet
CPI¹⁾, Palo Alto [14,19,710]	28	TE ₀₂	TE ₀₂	15	38	40	roomtemp.
	28 (2Ω _c)	TE ₀₂	TE ₀₂	10.8	33.6	30	roomtemp.
	60	TE ₀₂	TE ₀₂	30	38	40	cryo. mag.
CPI, NIFS [61-63,332-335] Palo Alto, Toki	84	TE _{15,3}	TEM ₀₀	50	14	80	cryo. mag.
GYCOM/IAP Nizhny Novgorod, [1,15,79,94,202-206, 209,212-215,217-222, 338,521,522,711,763-776]	13(15)	TE ₀₁	TE ₀₁	0.3(4)	20(50)	25(15)	roomtemp.
	24.1 (2Ω _c)	TE ₁₁	TE ₁₁	3.5	23	12	roomtemp.
	24.1 (2Ω _c)	TE ₋₂₁	TE ₁₁	3.4	23	15	PM, 116kg
	24.1	TE ₃₂	TE ₃₂	36	50	33	roomtemp.
	24.1 (2Ω _c)	TE ₁₂	TE ₁₂	13	50	25	roomtemp.
				28	32	25	roomtemp.
				6.5	60 (SDC)	17.5	roomtemp.
	28/30 (2Ω _c)	TE ₀₂	TE ₀₂	10	42	26	roomtemp.
				30	35	26	roomtemp.
	28.1/28.7 (2Ω _c)	TE ₀₃ /TE ₂₃	TE ₀₃ /TE ₂₃	10	20	23-24	2 kHz frequency switching
	28.25 (2Ω _c)	TE ₁₂	TE ₁₂	12	20	25	PM, 68 kg ²⁾
	31.8-34.8	TE ₁₁	TE ₁₁	1.2	40	12	mech. tun.
	35.5-37.5	TE ₀₁	TE ₀₁	0.5	15.3	16	mech. tun.
	35.15	TE ₀₂	TE ₀₂	9.7	43	25	cryo. mag.
	35	TE ₀₂	TEM ₀₀	10-50	30-40	25-30	cryo. mag.
	37.5	TE ₆₂	TEM ₀₀	20	35	30	cryo. mag.
	68-72	TE ₁₃	TE ₁₃	1.4	22	17.5	mech. tun.
	83	TE ₉₃	TEM ₀₀	10-50	30-40	25-30	cryo. mag.
	150	TE ₀₃	TE ₀₃	22	30	40	cryo. mag.
	157 (2Ω _c)	TE ₀₃	TE ₀₃	2.4	9.5	18	cryo. mag.
191.5 (2Ω _c)			0.55	6.2	22	cryo. mag.	
250 (2Ω _c)	TE ₀₂	TE ₀₂	4.3	18	20	cryo. mag.	
250 (2Ω _c)	TE ₆₅	TE ₆₅	1	5	20	cryo. mag.	
326 (2Ω _c)	TE ₂₃	TE ₂₃	1.5	6	20	cryo. mag.	
MICRAMICS, San Jose [777]	24.1 (2Ω _c)	TE ₂₂	TEM _{mixed}	5	25	23	roomtemp.
			TE ₂₂	10	25	23	roomtemp.
MITSUBISHI, Amagasaki [216,778-780]	28 (2Ω _c)	TE ₀₂	TE ₀₂	10	38.7	21	PM, 600 kg ²⁾ tapered B
UESTC, Chengdu [781]	37.5	TE ₁₃	TE ₁₃	57 (0.4 average)	9	50.5	roomtemp.
UNIV. Fukui, IAP Nizhny Novgorod/ GYCOM [208,782-789]	300	TE _{22,8}	TEM ₀₀	2.3	16.4	14	cryo. mag.

¹⁾ Communications & Power Industries, formerly VARIAN

²⁾ PM: permanent magnet

Table XVII: Performance of present CW gyrotron oscillators for technological applications.

IAP Nizhny Novgorod and GYCOM have developed a dual-frequency materials processing system employing a 15 kW, 28 GHz gyrotron and a 2.5 kW, 24.1 GHz tuneable gyro-BWO (see Table XXVIII) [209,212,213]. This system has been installed at the University of Fukui, Japan.

9 Relativistic Gyrotrons

Institution	Frequency [GHz]	Mode	Voltage [MV]	Current [kA]	Power [MW]	Efficiency [%]	Type	
IAP, Nizhny Novgorod [790-797]	9.23	TE ₀₁	0.27 (0.28)	0.12 (0.06)	10 (7.0)	32 (55)		
	20	TM ₀₁	0.5	0.7	40	11.4		
	30	TE ₅₃	0.3	0.08	12	50		
	30 (35)	TE _{5,3} (TE _{6,3})	0.38	0.11	20	50		
	79-107	TM _{1n}	0.5	2-6.5	30	3-1	slotted echelette cavity, n = 3-10	
IAP, Nizhny Novgorod Lebedev/General Phys. Inst. Moscow [791,798-800]	10	TE ₁₃	0.3	0.4	25	20	slotted cavity	
	10	TE ₁₃	0.3	1.0	60	15	plasma-filled slotted cavity	
Inst. Moscow [791,798-800]	40	TE ₁₃	0.4	1.3	25	5	slotted cavity	
	12	TE ₁₃	0.12	8.0	60	6.3	plasma filled slotted cavity	
KIPT, Kharkov [801]	2.88	TE ₀₁ ^r	0.8	2 (7)	20	1.3 (0.4)	small orbit	
			0.8	0.35 (1.2)	6	2.1 (0.06)	large orbit	
	2.15	TE ₁₀ ^r	0.8	0.35 (1.2)	14	5.0 (0.15)	large orbit	
	2.5	TE ₁₁ ^c (coax.)	0.8	0.8 (4.0)	90	14 (2.8)	large orbit, slotted cavity	
					40		unslotted cavity	
					20		unsl. noncoax. cavity	
UNIV. Michigan [802-808]	10	TE ₁₁	0.4	0.025	0.6	6		
	NRL, Washington D.C. [809-812]	8.35-13	4-5 modes	3.3	80	1000	0.4	superradiant
		35	TE ₆₂	0.78	1.6 (3.5)	100	8 (4) ^{*)}	
				1.15	2.5	275	10	
	35	TE ₁₃	0.9	0.65	35	6	slotted cavity	
Tomsk Polytech. Inst. [813]	3.1		0.75	8.0 (30)	1800	8	also vircator interaction	
UNIV. Niigata [814]	18.2	TE ₀₁	0.08	0.5	0.2	0.55		
UNIV. Strathclyde [815-820]	23	TE ₁₂	0.1	0.5	5	10%		
	100		0.2	0.22	6.3	14		

r: rectangular waveguide

*) operation from 28 to 49 GHz by magnetically tuning through a family of TE_{m2} modes, with the azimuthal index m ranging from 4 to 10

Table XVIII: Present development status of relativistic gyrotron oscillators.

Institution	Frequency [GHz]	Mode	Harmonic No. s	Voltage [MV]	Current [kA]	Power [MW]	Efficiency [%]
IAP, Nizhny Novgorod [278,759,821-829]	21.6	TE ₁₁	1	0.3	0.03 (3)	1.5	16.7 (0.17)
	35.7	TE ₂₁	2	0.3	0.03 (3)	1.5	16.7 (0.17)
	49.1	TE ₃₁	3	0.3	0.03 (3)	0.5	6.7 (0.07)
	62.4	TE ₄₁	4	0.3	0.03 (3)	0.2	2.2 (0.02)
	74.9	TE ₅₁	5	0.3	0.03 (3)	0.12	1.3 (0.013)
	115.2	TE ₃₂	3	0.25	0.008	0.1	5.0
	130.3	TE ₄₂	4	0.25	0.008	0.1	5.0
	223	TE ₂₅	2	0.25	0.003	0.045	6.0
	369	TE ₃₅	3	0.25	0.003	0.019	2.5
	371	TE ₃₈	3	0.25	0.002	0.010	2.0
	414	TE ₃₉	3	0.25	0.002	0.008	1.7
	469	TE ₃₅	3	0.25	0.003	0.020	2.5

Table XIX: Relativistic large orbit harmonic pulse gyrotrons with axis-encircling electron beam. The 21.6 GHz to 74.9 GHz experiments used an explosive-emission cathode with kicker ($\tau = 10$ ns) and the 115 GHz to 469 GHz experiments employed a quasi-Pierce type thermionic gun with kicker ($\tau = 10$ μ s, 1 Hz).

10 Quasi-Optical Gyrotrons

Institution	Frequency [GHz]	Mode resonator	Power [kW]	Efficiency [%]	Pulse length [ms]	Type
ABB, Baden [254,312]	92	TEM _{00q}	90	10	10	
CRPP, Lausanne [75,76,254,830]	90.8	TEM _{00q}	150	15	5	
	100	TEM _{00q}	90	15	15	
	200 (2 Ω_c)	TEM _{00q}	8	3.5	15	
IAP, Nizhny Novgorod [831]	100	TE ₀₆₁	260	6.5	0.04	echelette cavity
MIT, Cambridge [832,833]	136	HE ₀₆₁ ⁰	83	18	0.003	confocal
	114.3	HE ₀₅₁ ⁰	75	16	0.003	slot-cavity
Moscow-State UNIV. [834]	35	TEM _{00q}	1	15	CW	
	95	TEM _{00q}	1	15	CW	
NRL, Washington D.C. [647,835,836]	110	TEM _{00q}	80	8	0.013	
			600	9	0.013	
			431	12.7 (SDC)	0.013	
	120	TEM _{00q}	197	16.1 (SDC)	0.013	
			600	9	0.013	
			200	12	0.013	
TOSHIBA, Otawara [429]	112	TEM _{00q}	100	12	5	
	120	TEM _{00q}	26	10 (DEB)	3	

SDC: Single-stage Depressed Collector

DEB: Dual Electron Beam (1 annular beam, 1 pencil beam)

Table XX: Present development status of quasi-optical gyrotron oscillators.

11 Cyclotron Autoresonance Masers (CARMs)

Institution	Frequency [GHz]	Mode	Power [MW]	Efficiency [%]	Gain [dB]	B-Field [T]	Voltage [MV]	Current [kA]	Type
IAP	31.5-34.5	TE ₁₁ [*] /TE ₂₁ (2Ω _c)	3.4	17 (0.21)	-	1.05-1.2	0.40	0.05 (4)	CARM-BWO
IAP	35.7	TE ₅₁	30	10	-	1.12	0.4	0.6	oscillator
IAP	36.5	TE ₁₁	9	18 (0.45)	-	1.15	0.4	0.6	oscillator
IAP, IHCE	37.5	TE ₁₁	10	4	30	0.5	0.5	0.5	amplifier
IAP, U. Strath., HERC	37.5	TE ₂₁	0.2	0.5 (0.25)	-	-	0.15	0.25 (0.5)	superradiance
IAP	38	TE ₁₁ [*] /TE ₂₁ (2Ω _c)	13	26 (0.65)	-	1.24	0.5	0.1 (4)	CARM-gyrotron
	40	TE ₁₁	6	22 (0.44)	-	-	0.46	0.06 (0.3)	oscillator
IAP, IHCE, JINR	50	TE ₁₁	30	10	-	0.7	1.0	0.3	oscillator
IAP	66.7	TE ₂₁	15	3	-	0.6	0.5	1.0	oscillator
IAP, IHCE, JINR	68	TE ₁₁	50	8	-	1.0	1.2	0.5	oscillator
IAP	69.8	TE ₁₁	6	4	-	0.6	0.35	0.4	oscillator
IAP [821,822,837-846]	125	TE ₄₁	10	2	-	0.9	0.5	1.0	oscillator
LLNL Livermore [847]	220	TE ₁₁	50	2.5	-	3.0	2.0	1.0	oscillator
MIT Cambridge [266,848,849]	27.8	TE ₁₁	1.9	5.3	-	0.6	0.45	0.080	oscillator
	30	TE ₁₁	0.1	3	-	0.64	0.3	0.012	oscillator
	32	TE ₁₁	0.11	2.3	-	0.63	0.32	0.015	oscillator
	35	TE ₁₁	12	6.3 (0.04)	30	0.7	1.5	0.13 (20)	amplifier
UNIV. Michigan [850,851]	15	TE ₁₁	7	1.5	-	0.45	0.4	1.2	oscillator
UNIV. Strathclyde [852-854]	13	TE ₁₁	-	-	-	0.3	0.4	0.04	oscillator
	14.3 (2Ω _c)	TE ₂₁	0.18	4 (0.4)	-	0.2	0.3	0.015 (0.15)	oscillator

* output

HERC Moscow, IAP Nizhny Novgorod, IHCE Tomsk, JINR Dubna

Table XXI: State-of-the-art of fast-wave CARM experiments (short pulse).

Institution	Frequency [GHz]	Mode	Power [MW]	Efficiency [%]	Gain [dB]	B-Field [T]	Voltage [MV]	Current [kA]	Type
UNIV. Lomonosov, Moscow [267]	9.5	TM ₀₁	35	3.5	-	1.15	0.4	2.5	oscillator corr.w.g.
Tomsk Polytechn. Inst. [268]	25		20	0.2	-	0.64	0.9	14	oscillator diel.w.g.
UNIV. Niigata, NIFS, UNIV. Maryland [269]	19.5	TM ₀₁	0.2	3.8	-	0.9	0.035	0.15	oscillator corr.w.g.
UNIV. Yale, NRL, Washington D.C. [270]	6.2	TE ₀₁	0.02	10	53	0.2	0.05	0.005	amplifier diel.w.g.

Table XXII: State-of-the-art of slow-wave CARM experiments (short pulse).

12 Gyroklystrons, Gyro-TWT's, Gyrotwystrons, Gyro-BWOs and other Gyro-Devices

• Weakly Relativistic Pulse Gyroklystrons

Institution	Frequency [GHz]	Mode	No. of cavities	Power [kW]	Efficiency [%]	Gain [dB]	BW [%]	Type
CPI ¹⁾ , Palo Alto [19,251]	10 ($2\Omega_c$)	TE ₀₁	3	20	8.2	10	0.2	
	28	TE _{01/02}	2	76	9	30	0.2	
	35			65		30	0.2	
CPI, Litton, NRL, U.M. [232,396,855-862]	93.8	TE ₀₁	4	118	29.5	24.7	0.64	SN1
			5	130	33	39.5	0.75	SN2
GYCOM-M(TORIY), Moscow [863,864]	35.2	TE ₀₂	2	750 (5av.)	24	20	0.6	max. power
			2	350	32	19	0.9	max. efficiency
	35.0	TE ₀₁	4	160	48	42	1.4	
IAP Nizhny Novgorod [865-877]	9.25	TE ₀₁	2	4	50	22	1.0	
			3	16	45	22	1.0	
	15.2	TE ₀₁	3	50	50	30	0.5	
	15.8	TE ₀₂	3	160	40	30	0.5	max. efficiency
	32.4 ($2\Omega_c$)	TE ₀₂	3	300	22	22	0.1	PM, 350 kg
	34	TE ₀₁	4	280	32	34	0.53	
	35.12 ($2\Omega_c$)	TE ₀₂	2	258	18	17	0.3	tapered B-field
	35	TE ₀₂	2	300(230)	22(30)		0.3	2-cav. Gyrotron
	93.2	TE ₀₁	4	65	26	35	0.3	max. power
			4	57	34	40	0.3	max. efficiency
	93.5	TE ₀₂	2	140	18	18	0.35	
			2	207	30	21	0.2	shaped B
	93.2	TE ₀₂	3	340	24.5	23	0.3	shaped B
IECAS, Beijing [878-880]	35 ($2\Omega_c$)	TE ₀₂	3	212	16	24	0.44	
Kwangwoon Univ., Seoul [881]	27.85	TE ₀₁	5	150	26	50	0.1	
NRL, Washington D.C. [229-232,251,647, 882-893]	4.5	TE ₁₀	3	54	30	30	0.4	
	34.95	TE ₀₁	2	210	37	24	0.35	
	34.9	TE ₀₁	3	225	31	30	0.82	
	34.9	TE ₀₁	4	208	30	53	0.5	
	85	TE ₁₃	2	50		20		
	85.5	TEM ₀₀	2	82	19	18		QOGK
				82	30 (SDC)	18		QOGK
93.4	TE ₀₁	4	60	60	25	27	0.69	max. BW
			84	84	34	42	0.37	max. power
			72	72	27	48	0.44	max. pow.xBW
			300 (5 av.)	300 (5 av.)	30	36	1.0	

• Weakly Relativistic CW Gyroklystrons

Institution	Frequency [GHz]	Mode	No. of cavities	Power [kW]	Efficiency [%]	Gain [dB]	BW [%]	Type
CPI, Litton, NRL, U.M. [229-233,319,857-862]	93.8	TE ₀₁	4	10.1	33.5	32	0.45	(92 kW, 11% duty)
	94.2	TE ₀₁	5	10.2	31	33	0.75	(102 kW, 10% duty)
IAP N. Novgorod [867]	9.17	TE ₁₁	2	0.7	70	22	0.3	
IAP/ISTOK Moscow [868,871]	91.6	TE ₀₁	4	2.5	25	31	0.36	

QOGK: Quasi-optical Gyroklystron;

SDC: Single-stage Depressed Collector

¹⁾ Communications & Power Industries, formerly VARIAN

Table XXIII: Weakly relativistic gyrokylystron experimental results.

Institution	Frequency [GHz]	Mode output	No. of cavities	Power [MW]	Efficiency [%]	Gain [dB]	BW [%]	Type
IAP, Nizhny Novgorod [895-900]	30	TE _{5,3}	2 (TE _{5,2} /TE _{5,3})	15	40	30	0.17	triode gun
		TE _{3,2}	3 (TE _{5,2} /TE _{5,2} /TE _{5,3})	12	30	38	0.17	
UNIV. Maryland [223-227,901-913]	8.57	TE ₀₁	3	75	32	30	0.2	coaxial
	9.875	TE ₀₁	2	24	30	33	0.2	
	9.87	TE ₀₁	3	27	32	36	0.2	max. power
			3	16	37	33	0.2	max. efficiency
			3	20	28	50	0.2	max. gain
	17.14 (2Ω _C)	TE ₀₂	3	27	13	25	0.1	coaxial
			4	18.5	7.0	23.3	0.35	coaxial
	19.76 (2Ω _C)	TE ₀₂	2	32	29	27	0.1	
29.57 (3Ω _C)	TE ₀₃	2	1.8	2.0	14	0.1		

Table XXIV: Relativistic pulse gyrokystron experimental results.

Institution	Frequency [GHz]	Mode	Power [kW]	Efficiency [%]	Gain [dB]	Bandwidth [%]	Type
BVERI, Beijing [914-917]	34.2	TE ₀₁	293(4.7 av.)	34.2	56	6.0	Periodic SiC loading
CPI¹⁾, Palo Alto [19,233,251,396,862, 918-921]	5.18	TE ₁₁	120	26	20	7.3	MIG
	5.2	TE ₁₁	64	14	17.5	7.3	Pierce-helix gun
	93.7	TE ₁₁	28	7.8	31	2	Pierce-helix gun
	95	TE ₀₁	1.5 (0.6 av.)	4.2	42	7.7	
E2V, Chelmsford [922]	10(2Ω _C)	TE ₋₂₁ /TE ₊₁₁	180				gridded gun
IAP, Nizhny Novgorod [923-933]	36.3(2Ω _C)	TE ₋₂₁ /TE ₊₁₁	180	27	25	10	cusplike gun with axis- encircl. beam shortpulse 3 μs longpulse 110 μs
			120	23	20	6	
	30.5(2Ω _C)	TE ₋₂₁ /TE ₊₁₁	4 (2.6)	22	27	1.3 (3.5)	CW operation
IECAS, Beijing [934]	35	TE ₀₁	110	15.7		5	2-stage
MIT, Cambridge [935-944]	140	HE ₀₆₁ ⁰	30	12	29	1.6	quasi-optical at 1 kW 400 ps modulation pulse
NRL, Washington D.C. [251,945-951]	32.5	TE ₁₀	6.3	10	16.7	33	1-stage tapered
	35.5	TE ₁₀	8	16	25	20	2-stage tapered
	32.3	TE ₁₀	50	28	25	11	folded waveguide axis-encircl. beam
	34.0	TE ₀₁	137	17	47	3.3	2-stage output
	35.6	TE ₁₁	70	17	60	17	2-stage output
UC Los Angeles/ Davis [952-964]	9.3	TE ₁₀	55	11	27	11	diel. coat. waveg.
	10.4 (3Ω _C)	TE ₃₁	6	5	11	3	axis-encircl. beam
	15.7 (2Ω _C)	TE ₂₁	207	12.9	16	2.1	slotted waveg.
	16.2 (8Ω _C)	TE ₈₁	0.5	1.3	10	4.3	axis-encircl. beam
	92	TE ₀₁	140	22	60	2.2	heavily loaded + short copper stage
NTHU, Hsinchu [272-274,965-971]	35.8	TE ₁₁	27	16	35	7.5	2-stage severed
	34.2	TE ₁₁	62	21	33	12	2-stage lossy (short)
	33.6	TE ₁₁	93	26.5	70	8.6	2-stage lossy (long)
UESTC, Chengdu [972-974]	34	TE ₀₁	160	22.8	40	5	lossy circuit
	47.6	TE ₀₁	152	21.7	41	4.2	lossy circuit
UNIV. Tel Aviv [975]	7.3	TE ₁₀	0.8	12	26		3-stage output

¹⁾Communications & Power Industries, formerly VARIAN

Table XXV: Present development status of weakly relativistic gyro-TWTs (short pulse).

Institution	Frequency [GHz]	Mode	Power [MW]	Efficiency [%]	Gain [dB]	Bandwidth [%]	Type
IAP, Nizhny Novgorod UNIV. Strathclyde [275,923-925,976-980]	9.4 ($2\Omega_C$)	TE ₋₂₁ /TE ₊₁₁	1.1	29	37	21	helical waveguide with $\Delta m=3$ perturb. Axis encircl. E-beam
	36.5 ($2\Omega_C$)	TE ₋₂₁ /TE ₊₁₁	3.0	27	33	20(ΔB)	see above
MIT, Cambridge [981]	17.1 ($2\Omega_C$)	TE ₂₁	2	4	40		Pierce-helix gun
	17.1 ($3\Omega_C$)	TE ₃₁	4	6.6	51		Pierce-helix gun
NRL, Washington D.C. *) [982,983]	35	TE ₁₁	20	11	30		explosive-emission gun, bifilar helical wiggler
UNIV. Strathclyde [984-989]	9.4 ($2\Omega_C$)	TE ₋₂₁ /TE ₊₁₁	0.22	20	24	21	thermionic MIG, superradiance
			1.3	27	47	3	cold cathode cusp gun

*) This gyro-TWT operated near the "grazing intersection" in the dispersion diagram could also have been considered a CARM amplifier with frequency 4.4 times the relativistic cyclotron frequency.

Table XXVI: Present development status of relativistic gyro-TWTs (short pulse).

- Weakly Relativistic Pulse Gyrotwystrons

Institution	Frequency [GHz]	Mode cavity	TW section	Power [kW]	Efficiency [%]	Gain [dB]	BW [%]
CPI ¹⁾ , Palo Alto [230,232,319,862]	94	TE ₀₁ (4 cav.)	TE ₀₁	59 (5.9 av.)	14.9	35	1.6
NRL, Washington D.C. [990]	4.5	TE ₁₀	TE ₁₀	73	22.5	37	1.5
	31.5	TE ₄₂ (2Ω _c)	TE ₄₂	160	25	30	1.3
	93.5	TE ₀₁ (3 cav.)	TE ₀₁	48	17.5	30	2.0
IAP, N.Novgorod, NRL Washington D.C. [991,992]	9.2	TE ₀₁ (2 cav.)	TE ₀₁	4.8	14	20	0.9
				4.4	27.5	18	1.6

¹⁾Communications & Power Industries, formerly VARIAN

- Weakly Relativistic Pulse Harmonic-Multiplying Inverted Gyrotwystrons/Gyro-TWT/Gyrotriotron

Institution	Frequency [GHz]	Mode cavity	TW section	Power [kW]	Efficiency [%]	Gain [dB]	BW [%]
IECAS [993-1000]	33.1	TE ₀₁ /coupled cavity (2Ω _c)	TE ₀₃ (Ω _c)	75	7.1	25	1.1
Seoul National UNIV. [1001]	33.9	TE ₁₀	TE ₁₀ (3Ω _c)	10 ⁻⁴	2 · 10 ⁻³	LO-gyro-TWT	3.8
UNIV. Maryland. [277,1002-1007]	31.8	TE ₂₂	TE ₄₂ (2Ω _c)	100	20	30	1.3
	33.7	TE ₀₂	TE ₀₃ (2Ω _c)	430	35	30	0.3
	34.6	TE ₀₂	TE ₀₃ (2Ω _c)	180	32	30	3.0
	32.5	TE ₀₂	TE ₀₃ (2Ω _c)	200	12	36	3.0
	35	TE ₀₂ /TE ₀₃ (2Ω _c) buncher	TE ₀₄ (2Ω _c)	110	32	53	3.0
	33.75	Gyrotriotron		126	12	27	3.2
TWT input stage (s ₁ =1) TE ₀₂ / 4-unit clustered cavities (s ₂ =2) TE ₀₃ / TWT output stage (s ₃ = 2) TE ₀₄							

- Relativistic Pulse Gyrotwystrons

Institution	Frequency [GHz]	Mode cavity	TW section	Power [MW]	Efficiency [%]	Gain [dB]	BW [%]
UNIV. Maryland [1008]	9.878	TE ₀₁	TE ₀₁	21.6	21	25.5	
	19.76	TE ₀₁ (9.88GHz)	TE ₀₂ (2Ω _c)	12	11	21	

Table XXVII: State-of-the-art of gyrotwystron experiments (short pulse).

- Weakly Relativistic Pulse Gyro-BWOs

Institution	Frequency [GHz]	Mode	Power [kW]	Efficiency [%]	Bandwidth [%]	Type
UNIV. Strathclyde IAP N. Novgorod [1009-1012]	8.6 ($2\Omega_C$)	TE ₊₂₁ /TE ₋₁₁	65	16.5	17	quasi-Pierce gun with kicker
IAP, N. Novgorod KIT ¹⁾ , Karlsruhe [209,770,925-932, 1013,1014]	24.7 ($2\Omega_C$)	TE ₊₂₁ /TE ₋₁₁	7	15 23 (SDC)	5	MIG CW operation
IAP, Nizhny Novgorod [924]	35-38 ($2\Omega_C$)	TE ₊₂₁ /TE ₋₁₁	34	7	15	quasi-Pierce gun with kicker
	35 ($2\Omega_C$)	TE ₊₂₁ /TE ₋₁₁	10	5	10	cusp gun with thermal cathode
IECAS, BVERI, Beijing [1015,1016]	17.2	TE ₀₁	48	10.5 21(SDC)	5	TE ₁₀ ^r output
MIT, Cambridge, LLNL, Livermore [1017]	140	TE ₁₂ ^c	2	2	9	
NRL, Washington D.C. [1018]	27.8	TE ₁₀ ^r	2	9	3	electr. tuning
	29.2	TE ₁₀ ^r	6	15	13	magn. tuning
NTHU, Hsinchu [1019-1027]	33.5	TE ₁₁ ^c	20-67 115 149 154 164	6.5-21.7 23 30 39 41	5 8.5 4 1 1	injection locked free running electr. + magn. tuning injection locked inverse injec. locked
		TE ₀₁ ^c	123	24.5	15.8	sliced circuit
		TE ₀₂ ^c	2.8	22.6	9.5	sliced circuit
UNIV. Strathclyde [1028-1030]	95 ($2\Omega_C$)	TE ₊₂₁ /TE ₋₁₁	12	20	5.2	magn. tuning, casp gun
UNIV. Utah [1031]	10	TE ₁₀ ^r	0.72	10	8	

r = rectangular waveguide; c = circular waveguide, ¹⁾formerly KfK, then FZK

- Relativistic Pulse Gyro-BWOs (pulse duration = 0.02-1 μ s)

Institution	Frequency [GHz]	Mode	Power [MW]	Efficiency [%]	BW [%]	Voltage [MV]	Current [kA]	Type
IAP, N. Novgorod [1032,1033]	10	TM ₁₁	200	22		0.45	2	Cherenkov with cycl. mode selection
	35($2\Omega_C$)	TE ₋₂₁ / TE ₊₁₁	1.15	10 axis	15(Δ B) encirl.	0.35 e-beam	0.032	hel. w.g. with $\Delta m=3$ perturb.
UNIV. Kanazawa [1034,1035]	9-13	TE ₁₀ ^r	1	0.75 (0.02)	1	0.45	0.3(10)	
UNIV. Michigan [1036,1037]	4-6	TE ₁₁	55(30)	8(4.3)	1	0.7	1	
	5-6($2\Omega_C$)	TE ₁₁	1	0.15	4			
USAF Phillips Lab. Aberdeen	4.2	TE ₂₁	4	1	1	0.4	1	
[1038,1039]	4.4	TE ₀₁	0.15	0.04	1	0.4	1	

r = rectangular waveguide

Table XXVIII: First experimental results on gyro-BWOs (short pulse).

Institution	Frequency [GHz]	Mode	Output Mode	Power [kW]	Efficiency [%]	Pulse length [ms]	Type
UC Davis [1040]	34.1 ($2\Omega_c$)	TE ₁₁ ^c	4x TE ₁₀ ^r	88	36	0.02	cusped gun
UNIV. Tohoku, Sendai [1041-1049]	10.0	TE ₁₁ ^r	TE ₁₁ ^r	10	36	0.02	magnetron-type cavity
	10.5 ($2\Omega_c$)	TE ₃₁ ^c	TE ₃₁ ^c	0.7	10		
				1.3	7		
	30.3 ($3\Omega_c$)	TE ₄₁ ^c	TE ₀₁ ^c	6.9	35 (75 electr.)		
			6.9	44(SDC) (92 electr.)			
	100 ($10\Omega_c$)	TE _{11,1} ^c	TE ₀₁ ^c	0.32	1.7 (5 electr.)		auto-res.
	10	TE ₂₁ ^c	TE ₂₁ ^c	1.5	25		

r = rectangular waveguide; c = circular waveguide, SDC = Single-stage depressed collector

Table XXIX: Experimental results of peniotrons.

Institution	Frequency [GHz]	Mode	Power [kW]	Efficiency [%]	Pulse length [ms]
UNIV. Tohoku, Sendai	69.85 ($3\Omega_c$)	TE ₀₂	8	6.75	0.2
Toshiba, Otawara	140 ($3\Omega_c$)	TE ₀₃	8	1	1
UNIV. Fukui [1050]					

Table XXX: Experimental results of gyropeniotrons.

Institution	Frequency [GHz]	No. of Cavities	Voltage [MW]	Current [A]	Power [MW]	Efficiency [%]	Gain [dB]	Pulse length [μ s]
BINP, Novosibirsk [280,281,1051-1053]	0.915	3	0.3	12	2.6	73	30	30
	7.01 ($2\Omega_c$)	5	0.427	230	55	56	72	1.1
NRL, Washington D.C. [1054-1059]	11.424 ($2\Omega_c$)	7	0.48	210	25	25	59	0.2
					12	12	59	1.2
NRL, Yale UNIV. / Omega-P [1059-1063]	34.3 ($3\Omega_c$)	7	0.455	187	17	19.5	47	0.1
					26	27	57	0.0005

BINP: Budker Institute of Nuclear Physics

Table XXXI: Experimental results of magnicons.

13 Free Electron Masers (FEMs)

Institution	Frequency [GHz]	B _w [T]	λ _w [mm]	Mode	Power [MW]	Efficiency [%]	Gain [dB]	Voltage [MV]	Current [kA]	Accelerator	Pulse-Length [μs]	Type
CEA/CESTA, LeBarp [1064-1074]	3	0.11	120	TE ₁₁ ^c	40	2.3		2.2	0.8	Ind. LINAC	0.025	spn.emiss.
	8.6	0.45	20	TEM ₀₀ (2 nd harm)	0.02	0.15		0.085	0.15	Pulse Line	0.25	Smith-Purcell
	33-36	0.3	80	TE ₁₁ ^c	50	7.1(0.06)	43	1.75	0.4(50)	Pulse Line	0.01	amplifier
	35	0.11	120	TE ₁₁ ^c	80	4.5(3.7)	39	2.2	0.8(1.0)	Ind. LINAC	0.01(0.05)	amplifier
	35	0.17	200	TE ₁₁ ^c	150	2.8(0.75)	45	6.7	0.8(3.0)	Ind. LINAC	0.01	amplifier
Columbia U. NY [1075-1077]	24	0.05/0.04	34/23	TE ₁₁ ^c /TM ₁₁ ^c	1	3.3	20	0.58	0.1	Pulse Line	0.15	amplifier
	150	0.18	17	TE ₁₁ ^c	5	5		0.8	0.12	Pulse Line	0.15	oscillator
DLR, Stuttgart [1078]	100	0.1	20	TE ₀₂ ^c	1	2		0.5	0.15	Pulse Line	0.03	spn.emiss.
ENEA Frascati [1079-1083]	85-150	0.61	25	TE ₀₁ ^r	0.0015	0.19		2.3	0.00035	Microtron	5.5	oscillator
EP Palaiseau [1084]	120	0.03	20	TE ₁₁ ^c	11.5	6.4		0.6	0.3	Electrostatic	0.02	superrad.
FOM Nieuwegein [287-297,1085]	206	0.2/0.16	40	HE ₁₁ ^r	0.73(0.5)	5.7(3.9)		1.77	0.0072	Electrostatic	0.5(3.5)	oscillator
	167	0.16	40	HE ₁₁ ^r	0.36(0.26)	3.1(2.3)		1.61	0.0071	Electrostatic	0.5(3.0)	oscillator
	169	0.16	40	HE ₁₁ ^r	0.1	0.9 (14 with MDC)		1.60	0.007	Electrostatic	36	oscillator
General Electric Microwave Lab. Palo Alto [285]	2.6	0.04	74.2	TE ₀₁ ^r	1.2	10	6	0.17	0.07	Modulator	5.0	amplifier
Palo Alto [285]	2.6-3.7	0.04	74.2	TE ₀₁ ^r	0.9	9.2	10	0.135	0.07	Modulator	5.0	amplifier
	15.7	0.2	23.6	TE ₀₁ ^c	1.65	6	6	0.23	0.125	Modulator	5.0	amplifier
IEE,China [298]	54	0.2	3.18	TE ₀₁ ^c	0.15	6	10(30)	0.07	0.037	Modulator	4.0	amplifier
	35	0.31	110		140	5.2	57	3.4	0.95	Ind. LINAC	0.05	amplifier
IAP, Nizhny Novgorod [1086-1088]	16.7	0.02		TE ₀₁ ^c	300	11		0.6	4.5	Electrostatic	0.03	oscillator
	42.8-47.2	0.03	24	TE ₁₀ ^r	7	12(0.5)		0.5	0.12(3)	Pulse Line	0.015	oscil./CRM
IAP/INP Novosib. / KIT ¹⁾ [1089-1111]	75	0.10	40	TEM	100	4.2		0.8	3.0	Pulse Line	1.0	oscillator
IAP/U. Strath./HERC [1112-1114]	28	0.22	16	TE ₁₁ ^c	0.15	0.38		0.2	0.2	Pulse Line	0.0005	superrad.
JINR Dubna/IAP N.Novg. [311,1115-1127]	29.3	0.11	60	TE ₁₁ ^c	6	5(4)		0.8	0.15(0.2)	Ind. LINAC	0.2	oscillator
	30	0.12	60	TE ₁₁ ^c	20 (30)	20(15)		0.8	0.13	Ind. LINAC	0.2 (0.1)	oscillator
	30.2	0.12	60	TM ₁₂ ^c /TE ₁₁ ^c	15	15(10)		0.8	0.15(0.2)	Ind. LINAC	0.2	oscillator
	35	0.19	72	TE ₁₁ ^c	30	10		1.5	0.2	Ind. LINAC	0.2	amplifier
	250	0.05	30	TE ₁₁ ^c	0.6	0.5	110	0.6	0.2	Ind. LINAC	0.04	amplifier
ILT/ILE Osaka [1129]	60-110	0.71	60	TE ₀₁ ^r	0.01	0.2		9.0	0.05	RF LINAC	4x10 ⁻⁶	oscillator
ISAS, Sagamihara [1130]	11.8	0.09	32.7	TM ₈₁ ^c	3	1		0.43	0.19	Pulse Line	0.4	oscillator
JAEA ²⁾ , Ibaraki [1131,1132]	45	0.18	45	TE ₁₁ ^c	6	2.9(0.4)	52	0.82	0.25(2.0)	Ind. LINAC	0.03	amplifier
KAERI, Korea [1133-1135]	27	0.13	32	TM ₁₁ ^c	0.001	0.15		0.4	0.0017	Electrostatic	10-30	oscillator
KEK, Tsukuba [1136-1140]	9.4	0.121	160	TE ₀₁ ^r	100	12.1(5.1)	21	1.5	0.55(1.3)	Ind. LINAC	0.015	amplifier
LANL, Los Alamos [1141]	11.2/16.4			TM _{02,03}	5	0.125		0.8	5.0	Modulator	1.0	oscil./amp.
LLNL, Livermore [239,1142-1147]	34.6	0.37	98	TE ₀₁ ^r	1000	34(7.2)	52	3.5	0.85(4.0)	Ind. LINAC	0.02	amplifier
	140	0.17	98	TE ₁₁ ^c	2000	13.3(10)	58	6.0	2.5(3.0)	Ind. LINAC	0.02	amplifier

500-1000 in up to 50 pulses (2kHz burst)

¹⁾formerly KfK, then FZK, ²⁾formerly JAERI,

Institution	Frequency	B _w	λ _w	Mode	Power	Efficiency	Gain	Voltage	Current	Accelerator	Pulse-Length	Type
	[GHz]	[T]	[mm]		[MW]	[%]	[dB]	[MV]	[kA]		[μs]	
MIT, Cambridge [848,1148-1151]	9.3	0.02	33	TE ₁₁ ^c	0.1	10	6	0.18	0.0055	Electrostatic	0.02	amplifier
	27.5	0.05	30	TE ₁₁ ^c	1	10.3(6.3)	-	0.32	0.03(0.05)	Electrostatic	1	oscillator
	33.4	0.15	32	TE ₁₁ ^c	61	27	50	0.75	0.3	Pulse Line	0.025	amplifier
	35.2	0.05	30	TE ₁₁ ^c	0.8	8.6(5.2)	26	0.31	0.03(0.05)	Electrostatic	1	amplifier
NRL, Washington D.C. [1152,1153]	13.2-16.6	0.1	25.4	TE ₁₁ ^c	4.2	18	29	0.245	0.094	Modulator	1.2	amplifier
	23-31	0.06	40	TE ₀₁ ^c	4	3		0.7	0.2	Ind. LINAC	0.035	amplifier
	35	0.14	30	TE ₁₁ ^c	17	3.2	50	0.9	0.6	Pulse Line	0.02	amplifier
	75	0.08	30	TE ₁₁ ^c	75	6	50	1.25	1.0	Pulse Line	0.02	superrad.
NSWC/MRC, Wash. D.C. [298]	95	0.2	100		10	4		2.5	0.1	Pulse Line	0.25	oscillator
RI, Moscow [1154]	6-25	0.03	48	TE ₁₁ ^c /TM ₀₁ ^c	10	1.7		0.6	1	Pulse Line	2	spon. emiss.
SIAE, Chengdu [1155]	37	0.125	34.5	TE ₁₁ ^c	7.6	5.4		0.5	0.28	Electrostatic	0.015	oscillator
SIOFM, Shanghai [1156,1157]	37.5	0.12	21	TE ₁₁ ^c	12	3.7	50	0.4	0.8	Pulse Line	0.02	amplifier
	39	0.126	22	TM ₀₁ ^c	14	4.4		0.4	0.8	Pulse Line	0.02	oscillator
	83-95	0.15	10	TE ₁₁ ^c /TM ₀₁ ^c	1	0.7		0.35	0.4	Pulse Line	0.02	spon. emiss.
TRW, Redondo Beach [1158]	35	0.16	20	TE ₀₁ ^r	0.1	9.2		0.3	0.004	Electrostatic	10	oscillator
	35	0.16	20	TE ₀₁ ^r	0.002	6.9	3	0.29	0.0001	Electrostatic	10	amplifier
UESTC, Chengdu [1159,1160]	90	Smith-Purcell		TEM ₀₀	0.03	0.03		0.46	0.2	Pulse Line	0.015	oscillator
UNIV. Liverpool [299]	8-12.4	0.1	30	TE ₁₀ ^r	2x10 ⁻⁵	0.9		0.12	1.8x10 ⁻⁵	Electrostatic	CW	oscillator
	9.9	0.017	19	TE ₁₀ ^r	10 ⁻⁶	0.2	18	0.05	1x10 ⁻⁵	Electrostatic	CW	amplifier
UNIV. Maryland [1141,1161,1162]	35	CHI-wiggl.	64	TE ₀₁ ^{coax}	0.0038	0.018	5	0.0011	0.0019	Electrostatic	1	amplifier
	86	0.38	9.6	TE ₀₁ ^r	0.25	3.3	24	0.45	0.017	Pulse Line	0.02	amplifier
UCSB Santa Barbara [1163-1165]	120-880	0.15	71.4		0.027	0.5		2-6	0.002	Electrostatic	1-20	oscillator
UNIV. Strathclyde [1166-1168]	8-16	0.11	45	TE ₁₁ ^c	1	5.7 (35 with MDC)	23	0.35	0.050	Pulse Line	0.08	amplifier
UNIV. Strath., IAP / KIT ¹⁾ [1169-1183]	32.5	0.13	23	TE ₁₁ ^c	0.5	5.0		0.3	0.03	Pulse Line	0.1	oscillator
	37.3	0.06	40	TEM/TE _{24,1} coaxial 2D-1D Bragg cavity	60	10		0.45	1.35	Pulse Line	0.15	oscillator
UNIV. Tel-Aviv [1184-1188]	4.5	0.03	44.4	TE ₀₁ ^r	0.0035	6.3		0.07	0.0008	Electrostatic	3	oscillator
	70-110	0.2	44.4	HE ₁₀ ⁽¹⁾	0.01	0.7(0.5)		1.1-1.5	0.001(0.0014)	Electrostatic	30000	oscillator
UNIV. Twente [1189]	35	0.19	30	TE ₁₁ ^c /TM ₀₁ ^c	2.3	0.6		0.5	0.75	Pulse Line	0.1	spon. emiss.

r: rectangular waveguide; c: circular waveguide; ¹⁾formerly KfK, then FZK

Table XXXII: State-of-the-art of millimeter- and submillimeter wave FEMs.

Electron beam line (with multi-stage depressed collector)

electron beam current :	12 A
body current :	< 20 mA
gun voltage :	80 kV
type of gun	triode gun, cathode operated in space-charge limited regime
normalized beam emittance	6 p mm mrad (before interaction)
electron beam energy :	1.35 - 2.0 MeV (130 - 250 GHz operation)
acceleration / deceleration :	electrostatic
focusing system	solenoids in period focusing arrays
pulse length	2 ms - 100 ms

Undulator

period	40 mm
pole gap	25 mm
number of periods	34
peak field strength section 1	0.20 T, 20 cells
section 2	0.16 T, 14 cells
drift gap	35 - 60 mm length, adjustable
focusing scheme	equal focusing in x- and y-direction
matching scheme	1/2 cell 1/4 strength, 1/2 cell 3/4 strength

mm-wave system

primary waveguide :	rectangular corrugated
waveguide dimensions :	15 x 20 mm ²
waveguide mode :	HE ₁₁
feedback and outcoupling :	via optical beam multiplication in stepped waveguides
feedback coefficient :	adjustable : 0 - 100 %
output window :	Brewster-angle boron-nitride window

mm-wave output power

mm-wave frequency ¹⁾ :	130 - 260 GHz
on-line tunability ²⁾ :	5 % on ms time-scale
output power :	1 MW
electronic efficiency :	5 %
system efficiency :	> 50 %

1) Slow frequency tuning by changing the electron beam energy from 1.35 to 2.0 MeV, and adjusting the height of the stepped waveguides (mechanical adjustment).

2) Frequency adjustable on ms-time scale, via a sweep of the electron beam energy. The bandwidth of the stepped waveguides is sufficient to sweep over 5%.

Table XXXIII: Design parameters of the FOM-FEM [287-297,1085]. The project was terminated in The Netherlands in the autumn of 2001 and is being rebuilt in Israel.

14 Comparison of Gyrotron and FEM for Nuclear Fusion

Table XXXIV lists a comparison of the main performance parameters and features of gyrotrons and FEMs for ECRH of plasmas in nuclear fusion research. The important advantage of the FEM is its fast and continuous frequency tunability and the possibility of very high peak power but the gyrotron is a much simpler device [4]. The cylindrical cavity gyrotron is the only mm-wave source which has had an extensive on-the-field experience during fusion plasma heating experiments over a wide range of frequencies and power levels (8-170 GHz, 0.1-1.0 MW) [6,26].

	Gyrotron Oscillator (cyclotron resonance maser axial magnetic field)	Free Electron Maser Oscillator (periodic transverse magnetic field)
1. Beam voltage	low (70 - 95 kV)	high (0.2 - 2 MV)
2. Magnetic field (140 GHz)	high (5.5, 1 st harmonic)	low (0.2 T, wiggler)
3. Frequencies	8 - 1300 GHz	270 MHz - visible
4. Frequency tunability	$\Delta U_{\text{beam}} + \Delta U_{\text{mod}}$: fast step tuning (5%) ΔB : slow step tuning (35%)	ΔU_{beam} : fast continuous tuning (10%) slow mechanical tuning (50%)
5. Electron beam	magnetron injection gun	Pierce electron gun, acceleration and deceleration tubes, beam optics
6. Ohmic losses in cavity	cutoff cavity 2 kW/cm ²	oversized circuit far away from cutoff
7. Power density in cavity	high	low
8. Longitudinal mode competition in cavity	single-mode operation	nonlinear temporal dynamics can bring broad frequency spectrum
9. Linearly polarized output mode	generated by internal quasi-optical mode converter	linearly polarized, low-order resonator mode
10. Number of internal quasi-optical mirrors	2-4 on ground potential 0.9% ohmic losses	15 - 25 (FOM FEM) phase coherence required mostly on 2 MW potential 6% ohmic losses
11. Absorbed power on first mirror (1 MW, 140 GHz)	3 kW	12 kW
12. Internal microwave diagnostics	not required	required
13. Output power present status	high average power 1 MW / 800 s / 170 GHz 0.92 MW / 1800 s / 140 GHz 0.8 MW / 3600 s / 170 GHz (coax. 2.2 MW / 15 ms / 165 GHz)	pulsed 2 GW / 20 ns / 140 GHz but very low duty cycle (LLNL amplifier) 0.73 / 500 ns / 206 GHz (FOM FEM)
14. Exp. system efficiency without energy recovery	55% 35%	low 5 - 10%
15. Collector loading	relatively low	high
16. Theor. system efficiency with depressed collector	60% (exp. 55%)	60% (exp. 14%)
17. Physical size	3 m x 3 m x 3 m	12 m x 3 m x 3 m
18. Theor. power unit	1.2 MW (coax., 4 MW)	5 MW

Table XXXIV: Comparison of parameters and features of gyrotrons and FEMs for ECRH.

Acknowledgments

The author would like to thank A. Arzhannikov, P.V. Kalinin, G.N. Kulipanov, S.A. Kuznetsov, N.A. Vinokurov and S.L. Sinitsky (Budker INP, Novosibirsk), M. Caplan, L. Ives, J. Neilson and M.E. Read (Calabazas Creek Research), R. Magne (CEA, Cadarache), M. Blank, M.J. Cattelino, S.R. Cauffman, T.S. Chu, K. Felch, H. Jory and R. Schumacher (CPI, Palo Alto), S. Alberti, T. Goodman, J.P. Hogge and M.Q. Tran (CRPP, Lausanne), J.R. Brandon, T. Schaich, C.W.O. Thompson and C. Wort (Element 6, Charters), W.A. Bongers (FOM Instituut "Rijnhuizen"), T. Idehara, S. Mitsudo, I. Ogawa and T. Saito (Fukui University), J.L. Doane, R. Freeman, J. Lohr, C.P. Moeller, R.A. Olstad and D.B. Remsen (General Atomics, San Diego), M.V. Agapova, V.I. Iljin, V.I. Kurbatov, S.A. Malygin, V.E. Myasnikov, V.O. Nichiporenko, V.B. Orlov, L.G. Popov, E.A. Solujanova, E.M. Tai and S.V. Usachev (GYCOM), V.L. Bratman, Yu. Bykov, G.G. Denisov, N. Ginzburg, M.Yu. Glyavin, V.A. Goldenberg, V.I. Khizhnjak, A.N. Kuftin, A. Litvak, V.I. Malygin, V.N. Manuilov, V.V. Parshin, A. Peskov, M.I. Petelin, A.B. Pavelyev, R. Rozental, A.G. Saviolov, E.V. Sokolov, N.I. Zaitsev, V.E. Zapevalov and E.V. Zasyupkin (IAP, Nizhny Novgorod), J.J. Feng, P.K. Liu and L. Luo (IECAS, Beijing), W. Kasperek, C. Lechte and B. Plaum (IGVP, Stuttgart), F. Leuterer, M. München, J. Stober, D. Wagner and H. Zohm (IPP Garching), H. Braune, V. Erckmann, H.P. Laqua and G. Michel (IPP, Greifswald), K. Kajiwara, A. Kasugai, Y. Oda, K. Sakamoto and K. Takahashi (JAEA, Naka), C. Darbos and M. Henderson (ITER, Cadarache), E. Borie, G. Dammertz, J. Flamm, G. Gantenbein, S. Illy, J. Jelonnek, J. Jin, S. Kern, W. Leonhardt, G. Link, M. Losert, A. Malygin, A. Meier, D. Mellein, I. Pagonakis, B. Piosczyk, A. Roy Choudhury, T. Rzesnicki, A. Samartsev, T. Scherer, A. Schlaich and M. Schmid (Karlsruhe Institute of Technology), G.I. Zaginaylov (Kharkov University), M.A. Shapiro, and R.J. Temkin (MIT, Cambridge), H. Asano and T. Kikunaga (MITSUBISHI, Amagasaki), S. Kubo, M. Sato, T. Shimosuma and S. Takayama (NIFS, Toki), J.P. Calame, Y. Carmel, B. Danly, A. Fliflet, H. Freund, M. Garven, S.H. Gold and B. Levush (NRL, Washington D.C.), Y. Tsunawaki (Osaka Sangyo University), G.G. Sominski and O.I. Louksha (State Polytechnical University, St. Petersburg), R. Phillips (Stanford University), A.W. Cross, A.D.R. Phelps and K. Ronald (Strathclyde University), E. Jerbi (Tel Aviv University), Ch. Liévin and P. Thouvenin (THALES ELECTRON DEVICES, Velizy), G.R. Neil (Thomas Jefferson Lab), K. Yokoo (Tohoku University Sendai), N.C. Luhmann, Jr. and D.B. McDermott (UC, Davis), L. Hongfu, Y. Liu and L. Shenggang (UESTC, Chengdu), K.R. Chu (National Taiwan University (NTU), Taipei), C.-Y. Tsai (National Tsing Hua University (NTHU), Hsinchu), O. Dumbrajs (University of Latvia, Riga), T.M. Antonsen, V.L. Granatstein, W. Lawson, G.S. Nusinovich and A.N. Vlasov (University of Maryland), R.M. Gilgenbach and Y.Y. Lau (University of Michigan), T. Imai, T. Kariya and R. Minami (University of Tsukuba) and J. Hirshfield (Yale University). This work could not have been done without their help, stimulating suggestions and useful discussions. The author also wishes to express his deep gratitude to Mrs. M. Huber and Mrs. Ch. Kastner for careful typing this manuscript.

This work, supported by the European Communities under the contract of Association between EURATOM and Forschungszentrum Karlsruhe, was carried out within the framework of the European Fusion Development Agreement. The views and opinions expressed herein do not necessarily reflect those of the European Commission.

References

- [1] Gaponov-Grekhov, A.V., Granatstein, V.L., 1994, Application of high-power microwaves. Artech House, Boston, London.
- [2] Thumm, M., 1997, Applications of high-power microwave devices, in "Generation and Application of High Power Microwaves". R.A. Cairns and A.D.R. Phelps, eds., Institute of Physics Publishing, Bristol and Philadelphia, 305-323.
- [3] Thumm, M., 2001, Novel applications of millimeter and submillimeter wave gyro-devices. *Int. J. Infrared and Millimeter Waves*, **22**, 377-386.
- [4] Thumm, M., 2002, Free-electron masers vs. gyrotrons: prospects for high-power sources at millimetre and submillimeter wavelengths. *Nuclear Instruments & Methods in Physics Research*, **A 483**, 196-194.
- [5] Thumm, M., 2005, High power gyro-devices for plasma heating and other applications. *Int. J. Infrared and Millimeter Waves*, **26**, 483-503.
- [6] Thumm, M.K.A., 2011, Recent developments on high-power gyrotrons – introduction to this special issue. *J. of Infrared, Millimeter, and Terahertz Waves*, **32**, 241-252.
- [7] Thumm, M., 2011, Gyro-devices and their applications, Proc. 12th IEEE Int. Vacuum Electronics Conference (IVEC 2011), Bangalore, India, PL-7, Plenary Talk. pp. 521-524.
- [8] Hirshfield, J.L., Granatstein, V.L., 1977, The electron cyclotron maser – an historical survey. *IEEE Trans. on Microwave Theory and Techniques*, **MTT-25**, 522-527.
- [9] Flyagin, V.A., Gaponov, A.V., Petelin, M.I., Yulpatov, V.K., 1977, The gyrotron. *IEEE Trans. Microwave Theory and Techniques*, **MTT-25**, 514-521.
- [10] Andronov, A.A., Flyagin, V.A., Gaponov, A.V., Goldenberg, A.L., Petelin, M.I., Usov, V.G., Yulpatov, V.K., 1978, The gyrotron: high power sources of millimetre and submillimetre waves. *Infrared Physics*, **18**, 385-393.
- [11] Petelin, M.I., 1993, Physics of advanced gyrotrons. *Plasma Phys. and Contr. Nucl. Fusion*, **35**, Supplement B, 343-351.
- [12] Flyagin, V.A., Goldenberg, A.L., Nusinovich, G.S., 1984, Powerful gyrotrons, in *Infrared and Millimeter Waves*, **Vol. 11**, ed. K.J. Button, Academic Press, New York, 179-226.
- [13] Flyagin, V.A., Nusinovich, G.S., 1988, Gyrotron oscillators. *Proceedings of the Institute of Electrical and Electronics Engineers*, **76**, 644-656 and, 1985, Powerful gyrotrons for thermonuclear research, in *Infrared and Millimeter Waves*, **Vol. 13**, ed. K.J. Button, Academic Press, New York, 1-17.
- [14] Felch, K., Huey, H., Jory, H., 1990, Gyrotrons for ECH application. *J. Fusion Energy*, **9**, 59-75.
- [15] Goldenberg, A.L., Denisov, G.G., Zapevalov, V.E., Litvak, A.G., Flyagin, V.A., 1996, Cyclotron resonance masers: state of the art. *Radiophys. and Quantum Electronics*, **39**, 423-446.
- [16] Gold, S.H., Nusinovich, G.S., 1997, Review of high-power microwave source research. *Rev. Scient. Instrum.*, **68**, 3945-3974.
- [17] Granatstein, V.L., Levush, B., Danly, B.G., Parker, R.K., 1997, A quarter century of gyrotron research and development. *IEEE Trans. on Plasma Science*, **PS-25**, 1322-1335.
- [18] Petelin, M.I., 1999, One century of cyclotron radiation. *IEEE Trans. on Plasma Science*, **PS-27**, 294-302 and private communications, Institute of Applied Physics, Russia.
- [19] Felch, K.L., Danly, B.G., Jory, H.R., Kreischer, K.E., Lawson, W., Levush, B., Temkin, R.J., 1999, Characteristics and applications of fast-wave gyrodevices. *Proc. of the IEEE*, **87**, 752-781.
- [20] Thumm, M., 2002, Progress in gyrotron development. *Fusion Engineering and Design*, **66-68**, 69-90.
- [21] Chu, K.R., 2004, The electron cyclotron maser. *Rev. Mod. Phys.*, **76**, 489-540.

- [22] Sakamoto, K., 2007, Progress of high-power-gyrotron development for fusion research. *Fusion Science and Technology*, **52**, 145-153.
- [23] Faillon, G., Kornfeld, G., Bosch, E., Thumm, M.K., 2008, Microwave Tubes, in "Vacuum Electronics – Components and Devices", J.A. Eichmeier, M.K. Thumm, eds., Springer, Berlin, Heidelberg, Germany, 1-84.
- [24] Thumm, M., 2009, History, present status and future of gyrotrons, Proc. 10th IEEE Int. Vacuum Electronics Conference (IVEC 2009), Rome, Italy, pp. 37-40.
- [25] Thumm, M., 2011, Progress on gyrotrons for ITER and future thermonuclear fusion reactors. *IEEE Trans. on Plasma Science*, **39**, 971-979.
- [26] Litvak, A., Sakamoto, K., Thumm, M., 2011, Innovation on high-power long-pulse gyrotrons. *Plasma Physics and Controlled Fusion*, **53**, 12402 (14 pp).
- [27] Luce, T.C., 2002, Applications of high-power millimeter waves in fusion energy research. *IEEE Trans. on Plasma Science*, **PS-30**, 734-754.
- [28] Imai, T., Kobayashi, N., Temkin, R., Thumm, M., Tran, M.Q., Alikae, V., 2001, ITER R&D: auxiliary systems: electron cyclotron heating and current drive system. *Fusion Engineering and Design*, **55**, 281-289.
- [29] Zohm, H., Gantenbein, G., Giruzzi, G., Günter, S., Leuterer, F., Maraschek, M., Meskat, J., Peeters, A.G., Suttrop, W., Wagner, D., Zabiégo, M., ASDEX Upgrade Team, ECRH Group, 1999, Experiments on neoclassical tearing mode stabilization by ECCD in ASDEX Upgrade. *Nuclear Fusion*, **39**, 577-580.
- [30] Gantenbein, G., Zohm, H., Giruzzi, G., Günter, S., Leuterer, F., Maraschek, M., Meskat, J., Yu, Q., ASDEX Upgrade Team, ECRH-Group (AUG), 2000, Complete suppression of neoclassical tearing modes with current drive at the electron-cyclotron-resonance frequency in ASDEX Upgrade tokamak. *Phys. Rev. Lett.*, **85**, 1242-1245.
- [31] Zohm, H., Gantenbein, G., Gude, A., Günter, S., Leuterer, F., Maraschek, M., Meskat, J.P., Suttrop, W., Yu, Q., ASDEX Upgrade Team, ECRH Group (AUG), 2001, The physics of neoclassical tearing modes and their stabilization by ECCD in ASDEX Upgrade. *Nuclear Fusion*, **41**, 197-202.
- [32] Zohm, H., Gantenbein, G., Gude, A., Günter, S., Leuterer, F., Maraschek, M., Meskat, J., Suttrop, W., Yu, Q., ASDEX Upgrade Team, ECRH-Group (AUG), 2001, Neoclassical tearing modes and their stabilization by electron cyclotron current drive in ASDEX Upgrade. *Physics of Plasmas*, **8**, 2009-2016.
- [33] Prater, R., 2005, Application of electron cyclotron current drive on ITER. *Journal of Physics: Conference Series*, **25**, 257-265.
- [34] Zohm, H., Thumm, M., 2005, On the use of step-tuneable gyrotrons in ITER. *Journal of Physics: Conference Series*, **25**, 274-282.
- [35] Wagner, D., Leuterer, F., Manini, A., Monaco, F., München, M., Ryter, R., Schutz, H., Zohm, H., Franke, T., Heidinger, R., Thumm, M., Kasperek, W., Gantenbein, G., Litvak, A.G., Popov, L.G., Nichiporenko, V.O., Myasnikov, V.E., Denisov, G.G., Tai, E.M., Solyanova, E.A., Malygin, S.A., 2006, New frequency step-tunable ECRH system for ASDEX Upgrade, *Int. J. of Infrared and Millimeter Waves*, **27**, 173-182.
- [36] Wagner, D., Leuterer, F., Manini, A., Monaco, F., München, M., Ryter, R., Schütz, H., Stober, J., Zohm, H., Franke, T., Danilov, I., Heidinger, R., Thumm, M., Gantenbein, G., Kasperek, W., Lechte, C., Litvak, A., Denisov, G., Tai, E., Popov, L., Nichiporenko, V., Myasnikov, V., Solyanova, E., Malygin, S., Meo, F., Woskov, P., 2007, The new multifrequency electron cyclotron resonance heating system for ASDEX Upgrade, *Fusion Science and Technology*, **52**, 313-320.
- [37] Zohm, H., 2007, Recent experimental progress in electron cyclotron resonance heating and electron cyclotron current drive in magnetically confined fusion plasmas. *Fusion Science and Technology*, **52**, 134-144.

- [38] Zohm, H., Gantenbein, G., Leuterer, F., Manini, A., Maraschek, M., Yu, Q., and the ASDEX Upgrade Team, 2007, Control of MHD instabilities by ECCD: ASDEX Upgrade results and implications for ITER. *Nuclear Fusion*, **47**, 228-232.
- [39] Wagner, D.H., Grünwald, G., Leuterer, F., Manini, A., Monaco, F., München, M.J., Schütz, H., Stober, J., Zohm, H., Franke, T., Thumm, M., Heidinger, R., Gantenbein, G., Meier, A., Kasperek, W., Lechte, C., Litvak, A.G., Denisov, G.G., Chirkov, A.V., Tai, E.M., Popov, L.G., Nichiporenko, V.O., Myasnikov, V.E., Solyanova, E.A., Malygin, S.A., Meo, F., Woskow, P.O., 2008, Present status of the new multifrequency ECRH system for ASDEX upgrade, *IEEE Trans. on Plasma Science*, **36**, 324-331.
- [40] Wagner, D., Stober, J., Leuterer, F., Sips, G., Grünwald, G., Monaco, F., München, M., Poli, E., Schütz, H., Volpe, F., Treutterer, W., Zohm, H., Franke, T., Thumm, M., Heidinger, R., Gantenbein, G., Meier, A., Kasperek, W., Lechte, C., Litvak, A., Denisov, G., Chirkov, A., Tai, E., Popov, L., Nichiporenko, V., Myasnikov, V., Solyanova, E., Malygin, S., 2008, Multi-frequency ECRH at ASDEX Upgrade, *Proc. 7th Int. Workshop on Strong Microwaves: Sources and Applications*, Nizhny Novgorod, ed. A.G. Litvak, Inst. of Applied Physics, Russian Academy of Sciences, Nizhny Novgorod, 2009, **Vol. 2**, pp. 304-311.
Wagner, D., Stober, J., Bäuml, S., Franke, T., Leuterer, F., Poli, E., Monaco, F., München, M., Schütz, H., Zohm, H., Thumm, M., Scherer, T., Meier, A., Gantenbein, G., Flamm, J., Kasperek, W., Lechte, C., Höhnle, H., Litvak, A.G., Denisov, G.G., Chirkov, A., Popov, L.G., Nichiporenko, V.O., Myasnikov, V.E., Tai, E.M., Solyanova, E.A., Malygin, S.A., 2009, Multi-frequency ECRH system at ASDEX Upgrade, *Proc. 34th Int. Conf. on Infrared, Millimeter and Terahertz Waves*, Busan, Korea, R4D06.0016.
- [41] Wagner, D.H., Stober, J.K., Leuterer, F., Sips, G., Grünwald, G., Monaco, F., München, M.J., Poli, E., Schütz, H., Volpe, F., Treutterer, W., Zohm, H., Franke, T., Thumm, M., Heidinger, R., Gantenbein, G., Meier, A., Kasperek, W., Lechte, C., Litvak, A.G., Denisov, G.G., Chirkov, A., Tai, E., Popov, L., Nichiporenko, V., Myasnikov, V., Solyanova, E., Malygin, S., 2009, Progress and first results with the new multifrequency ECRH system for ASDEX Upgrade, *IEEE Transactions on Plasma Science*, **37**, 395-402.
Wagner, D., Stober, J., Leuterer, F., Monaco, F., München, M., Schmid-Lorch, D., Schütz, H., Zohm, H., Thumm, M., Scherer, T., Meier, A., Gantenbein, G., Flamm, J., Kasperek, W., Höhnle, H., Lechte, C., Litvak, A.G., Denisov, G.G., Chirkov, A., Popov, L.G., Nichiporenko, V.O., Myasnikov, V.E., Tai, E.M., Solyanova, E.A., Malygin, S.A., 2010, Multi-frequency ECRH at ASDEX Upgrade, status and plans, *Proc. 35th Int. Conf. on Infrared, Millimeter and Terahertz Waves*, Rome, Italy, Tu-E1.4.
- [42] Wagner, D., Stober, J., Leuterer, F., Monaco, F., München, M., Schmid-Lorch, D., Schütz, H., Zohm, H., Thumm, M., Scherer, T., Meier, A., Gantenbein, G., Flamm, J., Kasperek, W., Höhnle, H., Lechte, C., Litvak, A.G., Denisov, G.G., Chirkov, A., Popov, L.G., Nichiporenko, V.O., Myasnikov, V.E., Tai, E.M., Solyanova, E.A., Malygin, S.A., 2011, Recent upgrades and extensions of the ASDEX Upgrade ECRH system. *J. of Infrared, Millimeter, and Terahertz Waves*, **32**, 274-282.
- [43] Stober, J., Bock, A., Höhnle, H., Reich, M., Sommer, F., Treutterer, W., Wagner, D., Giannone, L., Herrmann, A., Leuterer, F., Monaco, F., Maraschek, M., Mlynek, A., Müller, S., München, M., Poli, E., Schubert, M., Schütz, H., Zohm, H., Kasperek, W., Stroth, U., Meier, A., Scherer, T., Strauß, D., Vaccaro, A., Flamm, J., Thumm, M., Litvak, A., Denisov, G.G., Chirkov, A.V., Tai, E.M., Popov, L.G., Nichiporenko, V.O., Myasnikov, V.E., Soluyanov, A., Malygin, S.A., ASDEX Upgrade Team, 2012, ECRH on ASDEX Upgrade. System status, feed-back control, plasma physics results. *EPJ Web of Conferences*, **32**, 02011/1-8.

- [44] Darbos, C., Henderson, M., Albajar, F., Bigelow, T., Bonicelli, T., Chavan, R., Denisov, G.G., Fasel, D., Heidinger, R., Hogge, J.P., Kobayashi, N., Piosczyk, B., Rao, S.L., Rasmussen, D., Saibene, G., Sakamoto, K., Takahashi, K., Thumm, M., 2009, Progress in design and integration of the ITER electron cyclotron H&CD system, *Fusion Engineering and Design*, **84**, 651-655.
- [45] Henderson, M., Albajar, F., Alberti, S., Baruah, U., Bigelow, T., Becker, B., Bertizzolo, R., Bonicelli, T., Bruschi, A., Caughman, J., Chavan, R., Cirant, S., Collazos, A., Darbos, C., deBaar, M., Denisov, G., Farina, D., Gandini, F., Gassmann, T., Goodman, T.P., Heidinger, R., Hogge, J.P., Jean, O., Kajiwara, K., Kasperek, W., Kasugai, A., Kern, S., Kobayashi, N., Landis, J.D., Moro, A., Nazare, C., Oda, J., Pagonakis, I., Platania, P., Plaum, B., Poli, E., Porte, L., Piosczyk, B., Ramponi, G., Rao, S.L., Rasmussen, D., Rouden, D., Saibene, G., Sakamoto, K., Sanchez, F., Scherer, T., Shapiro, M., Sozzi, C., P. Spaeh, Strauss, D., Sauter, O., Takahashi, K., Tanga, A., Temkin, R., Thumm, M., Tran, M.Q., Zohm, H., Zucca, C., 2009, An overview of the ITER electron cyclotron H&CD system, *Proc. 34th Int. Conf. on Infrared, Millimeter and Terahertz Waves*, Busan, Korea, F2P101.0554.
- [46] Henderson, M., Albajar, F., Alberti, S., Baruah, U., Bigelow, T., Becket, B., Bertizzolo, R., Bonicelli, T., Bruschi, A., Caughman, J., Chavan, R., Cirant, S., Darbos, C., de Baar, M., Denisov, G., Farina, D., Gandini, F., Gassmann, T., Goodman, T.P., Heidinger, R., Hogge, J.P., Kajiwara, K., Kasperek, W., Kasugai, A., Kern, S., Kobayashi, N., Landis, J.D., Li, F., Litvak, A., Moro, A., Myasnikov, V., Nazare, C., Oda, J., Omori, T., Pagonakis, I., Parmer, D., Peters, B., Platania, P., Plaum, B., Poli, E., Porte, I., Piosczyk, B., Purohit, D., Ramponi, G., Rao, S.L., Rasmussen, D., Ronden, D., Saibene, G., Sakamoto, K., Sanchez, F., Scherer, T., Schreck, S., Singh, N.P., Shapiro, M., Sozzi, C., Spaeh, P., Straus, D., Sauter, O., Tai, E., Takahasi, T., Temkin, R., Thomas, P., Thumm, M., Zohm, H., 2011, Present status of the 24 MW 170 GHz ITER EC H&CD system, *Proc. 8th Int. Workshop Strong Microwaves and Terahertz Waves: Sources and Applications*, Nizhny Novgorod – St. Petersburg, Russia, July 9-16, 2011, pp. 21-22.
- [47] Omori, T., Henderson, M.A., Albajar, F., Alberti, S., Baruah, U., Bigelow, T., Beckett, B., Bertizzolo, R., Bonicelli, T., Bruschi, A., Caughman, J., Chavan, R., Cirant, S., Collazos, A., Cox, D., Darbos, C., de Baar, M.R., Denisov, G., Farina, D., Gandini, F., Gassmann, T., Goodman, T.P., Heidinger, R., Hogge, J.P., Kobayashi, N., Kumric, H., Landis, J.D., Moro, A., Nazare, C., Oda, Y., Pagonakis, I., Piosczyk, B., Platania, P., Plaum, B., Poli, E., Porte, L., Purohit, D., Ramponi, G., Rao, S.L., Rasmussen, D.A., Ronden, D.M.S., Rzesnicki, T., Saibene, G., Sakamoto, K., Sanchez, F., Scherer, T., Shapiro, M., Sozzi, C., Spaeh, P., Strauss, D., Suter, O., Takahashi, K., Temkin, R., Thumm, M., Tran, M.Q., Udintsev, V., Zohm, H., 2011, Overview of the ITER EC H&CD system and its capabilities. *Fusion Engineering and Design*, **86**, 951-954.
- [48] Prater, R., 2004, Heating and current drive by electron cyclotron waves. *Physics of Plasmas*, **11**, 2349-2376.
- [49] Erckmann, V., Kasperek, W., Plaum, B., Lechte, C., Petelin, M.I., Braune, H., Gantenbein, G., Laqua, H.P., Lubiako, L., Marushchenko, N.B., Michel, G., Turkin, Y., Weissgerber, M., and the W7-X ECRH-teams at IPP Greifswald, IPF Stuttgart, and KIT, 2012, Large scale CW ECRH systems: some considerations. *EPJ Web of Conferences*, **32**, 04009/1-6.
- [50] Erckmann, V., WVII-AS Team, Kasperek, W., Müller, G.A., Schüller, P.G., and Thumm, M., 1990, Electron cyclotron resonance heating transmission line and launching system for the Wendelstein VII-AS stellarator. *Fusion Technology*, **17**, 76-85.
- [51] Erckmann, V., Dammertz, G., Dorst, D., Empacher, L., Förster, W., Gantenbein, G., Geist, T., Kasperek, W., Laqua, H.P., Müller, G.A., Thumm, M., Weissgerber, H., Wobig, H., W7-X and W7-AS Teams at IPP Garching, W7-X Team at FZK Karlsruhe, W7-X Team at IPF Stuttgart, 1999, ECRH and ECCD with high power gyrotrons at the stellarators W7-AS and W7-X. *IEEE Trans. on Plasma Science*, **PS-27**, 538-546.

- [52] Kasperek, W., Erckmann, V., Laqua, H.P., Borie, E., Dammertz, G., Empacher, L., Förster, W., Gantenbein, G., Illy, S., Michel, G., Müller, G., Piosczyk, B., Thumm, M., Wagner, D., Weißgerber, M., Zohm, H., W7-X and W7-AS Teams at IPP Garching, W7-X Team at IPF Stuttgart, W7-X Team at FZK Karlsruhe, 1999, ECRH and ECCD for the stellarator W7-X. Proc. 4th Int. Workshop on Strong Microwaves in Plasmas, Nizhny Novgorod, ed. A.G. Litvak, Inst. of Applied Physics, Russian Academy of Sciences, Nizhny Novgorod, 2000, **Vol. 1**, 185-204.
- [53] Erckmann, V., Laqua, H.P., Maassberg, H., Geiger, J., Dammertz, G., Kasperek, W., Thumm, M., W7-X and W7-AS teams IPP, W7-X team FZK, W7-X team IPF, 2001, Electron cyclotron resonance heating and EC-current drive experiments at W7-AS, status at W7-X. Fusion Engineering and Design, **53**, 365-375.
- [54] Wanner, M., Erckmann, V., Feist, J.-H., Gardebrecht, W., Hartmann, D., Krampitz, R., Niedermeyer, H., Renner, H., Rummel, Th., Schauer, F., Wegener, L., Wesner, F., Müller, G.A., Kasperek, W., Thumm, M., Dammertz, G., 2003, Status of WENDELSTEIN 7-X construction, Nucl. Fusion, **43**, 416-424.
- [55] Dammertz, G., Braune, H., Erckmann, V., Gantenbein, G., Kasperek, W., Laqua, H.P., Leonhardt, W., Michel, G., Müller, G., Neffe, G., Piosczyk, B., Schmid, M., Thumm, M.K., 2004, Progress in the 10-MW ECRH system for the stellarator W7-X. IEEE Trans. on Plasma Science, **PS-32**, 144-151.
- [56] Erckmann, V., Brand, P., Braune, H., Dammertz, G., Gantenbein, G., Kasperek, W., Laqua, H.P., Maassberg, H., Marushchenko, N.B., Michel, G., Thumm, M., Turkin, Y., Weissgerber, M., Weller, A., W7-X ECRH Team at IPP Greifswald, W7-X ECRH Team at FZK Karlsruhe and W7-X ECRH Team at IPF Stuttgart, 2007, Electron cyclotron heating for W7-X: physics and technology, Fusion Science and Technology, **52**, 291-312.
- [57] Erckmann, V., W7-X ECRH teams at IPP, IPF and FZK, 2007, The W7-X ECRH plant: status and recent achievements, Proc. 17th Topical Conf. on Radio Frequency Power in Plasmas, Clearwater, Florida, USA, AIP Conf. Proc., Vol. 933, 421-424.
- [58] Erckmann, V., Brand, P., Braune, H., Gantenbein, G., Kasperek, W., Laqua, H.P., Lechte, C., Marushchenko, N.B., Michel, G., Thumm, M., Turkin, Y., Weissgerber, M., and the W7-X ECRH-teams at IPP Greifswald, IPF Stuttgart and FZK Karlsruhe, 2008, The 10 MW, CW, ECRH-plant for W7-X: status and high power performance, Proc. 7th Int. Workshop on Strong Microwaves: Sources and Applications, Nizhny Novgorod, ed. A.G. Litvak, Inst. of Applied Physics, Russian Academy of Sciences, Nizhny Novgorod, 2009, **Vol. 1**, pp. 60-69.
- [59] Thumm, M., Brand, P., Braune, H., Dammertz, G., Erckmann, V., Gantenbein, G., Illy, S., Kasperek, W., Kern, S., Laqua, H.P., Lechte, C., Leonhardt, W., Marushchenko, N.B., Michel, G., Piosczyk, B., Schmid, M., Turkin, Y., Weissgerber, W., 2010, Status and high power performance of the 10-MW 140-GHz ECH system for the stellarator Wendelstein 7-X. Plasma and Fusion Research, **5**, 1006/1-8.
- [60] Geiger, J., Wolf, R.C., Beidler, C., Cardella, A., Chlechowicz, E., Erckmann, V., Gantenbein, G., Hathiramani, D., Hirsch, M., Kasperek, W., Kießlinger, J., König, R., Kornejew, P., Laqua, H.P., Lechte, C., Lore, J., Lumsdaine, A., Maassberg, H., Marushchenko, N.B., Michel, G., Otte, M., Peacock, A., Sunn Pedersen, T., Thumm, M., Turkin, Y., Werner, A., Zhang, D., and the W7-X Team, 2013, Aspects of steady-state operation of the Wendelstein 7-X stellarator. Plasma Phys. Control. Fusion, **55**, 014006 (6 pp).
- [61] Ohkubo, K., Kubo, S., Shimosuma, T., Idei, H., Sato, M., Yoshimura, Y., Mizuno, Y., Ito, S., Kobayashi, S., Takita, Y., Kaneko, O., Kawahata, K., Komori, A., Ohyabu, N., Yamada, H., Ikeda, K., Oka, Y., Osakabe, M., Takeiri, K., Tsumori, K., Kumazawa, R., Mutoh, T., Saito, K., Seki, T., Watari, T., Ashikawa, N., Emoto, M., de Vries, P.C., Funaba, H., Goto, M., Ida, K., Inagaki, S., Isobe, M., Kado, S., Kobuchi, T., Masuzaki, S., Minami, T., Miyazawa, J., Morisaki, T., Morita, S., Murakami, S., Mutoh, S., Nagayama, Y., Nakamura,

- Y., Nakanishi, H., Narihara, K., Nishimura, K., Noda, N., Ohdachi, S., Ozaki, T., Pavlichenko, R.O., Peterson, B.J., Sagara, A., Sakakibara, S., Sakamoto, R., Sasao, H., Sasao, M., Sato, K., Shoji, M., Sudo, S., Suzuki, H., Takechi, M., Tanaka, K., Toi, K., Tokuzawa, T., Yamada, I., Yamaguchi, S., Yamamoto, S., Yamazaki, K., Yokoyama, M., Watanabe, K.Y., Motojima, O., Fujiwara, M., 1999, Electron cyclotron plasma production and heating on LHD: system and its application. Proc. 4th Int. Workshop on Strong Microwaves in Plasmas, Nizhny Novgorod, ed. A.G. Litvak, Inst. of Applied Physics, Russian Academy of Sciences, Nizhny Novgorod, 2000, **Vol. 1**, 27-40.
- [62] Idei, H., Kubo, S., Shimosuma, T., Sato, M., Ohkubo, K., Yoshimura, Y., Takita, Y., Kobayashi, S., Ito, S., Mizuno, Y., Tsumori, K., Ikeda, K., Notake, T., Watari, T., Kaneko, O., Komori, A., Yamada, H., de Vries, P.C., Goto, M., Ida, K., Inagaki, S., Kado, S., Kawahata, K., Kobuchi, T., Minami, T., Miyazawa, J., Morisaki, T., Morita, S., Murakami, S., Muto, S., Nagayama, Y., Nakanishi, H., Narihara, K., Peterson, B.J., Sakakibara, S., Sasao, H., Sato, K., Tanaka, K., Takeiri, Y., Watanabe, K.Y., Yamada, I., Motojima, O., Fujiwara, M., LHD Experimental Group, 2001, Electron cyclotron heating scenario and experimental results in LHD. *Fusion Engineering and Design*, **53**, 329-336.
- [63] Shimosuma, T., Kubo, S., Idei, H., Yoshimura, Y., Notake, T., Watari, T., Mizuno, Y., Ito, S., Kobayashi, S., Takita, Y., Sato, M., Ohkubo, K., Ida, K., Ohyabu, N., Yamada, I., Narihara, K., Inagaki, S., Nagayama, Y., Takeiri, Y., Funaba, H., Yokoyama, M., Murakami, S., and the LHD Experimental Group, 2002, Recent results of ECH experiment by an upgraded heating system in LHD. Proc. 5th Int. Workshop on Strong Microwaves in Plasmas, Nizhny Novgorod, ed. A.G. Litvak, Inst. of Applied Physics, Russian Academy of Sciences, Nizhny Novgorod, 2003, **Vol. 1**, 307-319.
- [64] Igami, H., Notake, T., Yoshimura, Y., Shimosuma, T., Kubo, S., Ohkubo, K., Inagaki, S. and LHD Experimental Group, 2005, High power injection and steady state ECRH operation in LHD. Proc. 6th Int. Workshop on Strong Microwaves in Plasmas, Nizhny Novgorod, ed. A.G. Litvak, Inst. of Applied Physics, Russian Academy of Sciences, Nizhny Novgorod, 2006, **Vol. 2**, 398-408.
- Nishiura, M., Tanaka, K., Kubo, S., Saito, T., Tatematsu, Y., Notake, T., Kawahata, K., Shimosuma, T., Mutoh, T., 2008, Design of collective Thomson scattering system using 77 GHz gyrotron for bulk and tail ion diagnostics in the large helical device, *Review of Scientific Instruments*, **79**, 10E731-1 – 10E731-3.
- [65] Thumm, M., 1994, Progress in the development of high-power millimeter- and submillimeter wave gyrotrons and of free electron masers. *Archiv für Elektrotechnik* **77**, 51-55.
- [66] Thumm, M., 1995, Advanced electron cyclotron heating systems for next step fusion experiments. *Fusion Engineering and Design*, **30**, 139-170.
- [67] Thumm, M., 1997, Recent development of high power gyrotrons and windows for EC wave applications. Proc. 12th Topical Conf. on Radio Frequency Power in Plasmas, Savannah, Georgia, USA, AIP Conference Proceedings **403**, 183-190.
- Thumm, M., 1997, Present developments and status of electron sources for high power gyrotron tubes and free electron masers. *Applied Surface Science*, **111**, 106-120.
- [68] Thumm, M., 1998, State-of-the-art and recent developments of high-power gyrotron oscillators. Proc. Radio Frequency Workshop (RF 98), High Energy Density Microwaves, Pajaro Dunes, California, USA, AIP Conference Proceedings **474**, 146-162.
- [69] Thumm, M., 2003, MW gyrotron development for fusion plasma applications. *Plasma Phys. Control. Fusion*, **45**, A143-A161.

- [70] Thumm, M., Alberti, S., Arnold, A., Bariou, D., Dammertz, G., Darbos, C., Dumbrajs, O., Gantenbein, G., Erckmann, V., Giguët, E., Heidinger, R., Hogge, J.-P., Illy, S., Jin, J., Kasperek, W., Liévin, C., Magne, R., Michel, G., Piosczyk, B., Prinz, O., Rzesnicki, T., Schwörer, K., Tran, M.Q., Yang, X., Yovchev, I., 2005, Gyrotron development in the EU for present fusion experiments and for ITER. Proc. 7th Workshop on High Energy Density and High Power RF, AIP Conference Proceedings **807**, 2006, 167-179.
- [71] Dammertz, G., Alberti, A., Arnold, A., Bariou, D., Brand, P., Braune, H., Erckmann, V., Dumbrajs, O., Gantenbein, G., Giguët, E., Heidinger, R., Hogge, J.-Ph., Illy, S., Jin, J., Kasperek, W., Koppenburg, K., Laqua, H.P., Legrand, F., Leonhardt, W., Liévin, Ch., Michel, G., Neffe, G., Piosczyk, B., Prinz, O., Rzesnicki, T., Schmid, M., Thumm, M., Tran, M.Q., Yang, X., Yovchev, I., 2006, High-power gyrotron development at Forschungszentrum Karlsruhe for fusion applications, IEEE Trans. on Plasma Science, **PS-34**, 173-186.
- [72] Jelonnek, J., Alberti, S., Avramidis, K., Braune, H., Erckmann, V., Gantenbein, G., Hogge, J.P., Illy, S., Jin, J., Kern, S., Noke, F., Pagonakis, I., Piosczyk, B., Purps, F., Rzesnicki, T., Samartsev, A., Schlaich, A., Schmid, M., Thumm, M., 2012, High power gyrotron development at KIT for ECH&CD of fusion plasmas, Proc. 13th IEEE Int. Vacuum Electronics Conference and 9th IEEE Int. Vacuum Electron Sources Conference (IVEC-IVESC 2012), Monterey, CA, USA, pp. 111-112.
- [73] Dumbrajs, O., Nusinovich, G.S., 2004, Coaxial gyrotrons: past, present, and future (review). IEEE Trans. on Plasma Science, **PS-32**, 934-946.
- [74] Thumm, M., Kasperek, W., 1995, Recent advanced technology in electron cyclotron heating systems. Fusion Engineering and Design, **26**, 291-317.
Thumm, M.K., Kasperek, W., 2002, Passive high-power microwave components. IEEE Trans. on Plasma Science, **PS-30**, 755-786.
Henle, W., Jacobs, A., Kasperek, W., Kumric, H., Müller, G.A., Schüller, P.G., Thumm, M., Engelmann, F., Rebuffi, L., 1991, Conceptual study of multi-megawatt millimeter wave transmission and antenna systems for electron cyclotron wave applications in NET/ITER. Fusion Technology **1990**, eds. B.E. Keen, M. Huguet, R. Hemsworth. Elsevier Science Publishers B.V., 238-242.
Kasperek, W., Petelin, M., Shchegolkov, D., Erckmann, V., Bruschi, A., Braune, H., Hollmann, F., Jonitz, L., Michel, G., Laqua, H.P., Noke, F., Purps, F., Schulz, T., Brand, P., Plaum, B., Wubie, W., Koshurinov, Y., Lubyako, L., Bin, W., D'Arcangelo, O., and ECRH groups at IPP Greifswald, FZK Karlsruhe, IFP Milano, IAP Nizhny Novgorod, and IPF Stuttgart, 2008, High-power microwave diplexers for advanced ECRH systems, Proc. 7th Int. Workshop on Strong Microwaves: Sources and Applications, Nizhny Novgorod, ed. A.G. Litvak, Inst. of Applied Physics, Russian Academy of Sciences, Nizhny Novgorod, 2009, **Vol. 1**, pp. 27-39.
- [75] Alberti, S., Tran, M.Q., Hogge, J.P., Tran, T.M., Bondeson, A., Muggli, P., Perrenoud, A., Jödicke, B., Mathews, H.G., 1990, Experimental measurements on a 100 GHz frequency tunable quasi-optical gyrotron. Phys. Fluids, **B2**, 1654-1661.
- [76] Hogge, J.P., Tran, T.M., Paris, P.J., Tran, M.Q., 1996, Operation of a quasi-optical gyrotron with a gaussian output coupler. Phys. Plasmas, **3**, 3492-3500.
- [77] Kreisler, K.E. Temkin, R.J., 1987, Single-mode operation of a high-power, step-tunable gyrotron. Phys. Rev. Lett., **59**, 547-550.
- [78] Kurbatov, V.I., Malygin, S.A., Vasilyev, E.G., 1990, Commercial gyrotrons for thermonuclear investigations. Proc. Int. Workshop on Strong Microwaves in Plasmas, Suzdal, Inst. of Applied Physics, Nizhny Novgorod, 1991, 765-772.

- [79] Bogdanov, S.D., Kurbatov, V.I., Malygin, S.A., Orlov, V.B., Tai, E.M., 1993, Industrial gyrotrons development in Salut. Proc. 2nd Int. Workshop on Strong Microwaves in Plasmas, Moscow - Nizhny Novgorod - Moscow, ed. A.G. Litvak, Inst. of Applied Physics, Nizhny Novgorod, 1994, **Vol. 2**, 830-835.
- Zapevalov, V.E., Malygin, S.A., Pavelyev, V.G., Tsimring, Sh.E., 1984, Coupled resonator gyrotrons with mode conversion. Radiophys. Quantum Electron., **27**, 846-852.
- [80] Braz, O., Dammertz, G., Kuntze, M., Thumm, M., 1997, D-band frequency step-tuning of a 1 MW gyrotron using a Brewster output window. Int. J. Infrared and Millimeter Waves, **18**, 1465-1477.
- [81] Braz, O., Dammertz, G., Henry, S., Kuntze, M., Sato, M., Shimosuma, T., Thumm, M., 1998, Frequency step-tuned operation of a 1 MW, D-band gyrotron using a Brewster output window. Proc. 8th ITG-Conference on Displays and Vacuum Electronics, Garmisch-Partenkirchen, ITG-Fachbericht **150**, 299-304.
- [82] Thumm, M., Borie, E., Braz, O., Dammertz, G., Dumbrajs, O., Koppenburg, K., Kuntze, M., Piosczyk, B., 1999, 1.6 MW frequency step-tunable D-band gyrotron. Proc. 4th Int. Workshop on Strong Microwaves in Plasmas, Nizhny Novgorod, ed. A.G. Litvak, Inst. of Applied Physics, Russian Academy of Sciences, Nizhny Novgorod, 2000, **Vol. 2**, 591-609.
- [83] Dammertz, G., Dumbrajs, O., Koppenburg, K., Piosczyk, B., Thumm, M., 2000, Frequency-step-tunable high-power gyrotrons for plasma physics applications. J. Comm. Tech. and Electronics, **45**, S60-S64.
- [84] Dumbrajs, O., Nusinovich, G.S., 1992, Theory of a frequency-step-tunable gyrotron for optimum plasma ECRH. IEEE Trans. Plasma Science, **PS-20**, 452-457.
- [85] Thumm, M., Arnold, A., Borie, E., Braz, O., Dammertz, G., Dumbrajs, O., Koppenburg, K., Kuntze, M., Michel, G., Piosczyk, B., 2001, Frequency step-tunable (114-170 GHz) megawatt gyrotrons for plasma physics applications. Fusion Engineering and Design, **53**, 407-421.
- [86] Koppenburg, K., Dammertz, G., Kuntze, M., Piosczyk, B., Thumm, M., 2001, Fast frequency-step-tunable high-power gyrotron with hybrid-magnet-system. IEEE Trans. on Electron Devices, **ED-48**, 101-107.
- [87] Samartsev, A., Gantenbein, G., Dammertz, G., Illy, S., Kern, S., Leonhardt, W., Schlaich, A., Schmid, M., Thumm, M., 2011, Development of frequency step tunable 1 MW gyrotron at 131 to 146.5 GHz, Proc. 12th IEEE Int. Vacuum Electronics Conference (IVEC 2011), Bangalore, India, P2.22., 269-270.
- [88] Kuftin, A.N., Bogdashov, A.A., Chirkov, A.V., Denisov, G.G., Lygin, V.K., Moiseev, M.A., Zapevalov, V.E., 2001, Development of frequency step tunable 105-170 GHz 1 MW gyrotron. Conf. Digest, 26th Int. Conf. on Infrared and Millimeter Waves, Toulouse, France, 5-230-5-233.
- [89] Zapevalov, V.E., Bogdashov, A.A., Chirkov, A.V., Denisov, G.G., Kuftin, A.N., Lygin, M.A., Moiseev, M.A., 2002, Optimization of the frequency step tunable 105-170 GHz 1 MW gyrotron prototype. Proc. 27th Int. Conf. on Infrared and Millimeter Waves, San Diego, USA, 1-2.
- [90] Zapevalov, V.E., Bogdashov, A.A., Denisov, G.G., Kuftin, A.N., Lygin, V.K., Moiseev, M.A., Chirkov, A.V., 2004, Development of a prototype of a 1-MW 105-156-GHz multifrequency gyrotron. Radiophysics and Quantum Electronics, **47**, 396-404.
- [91] Popov, L.G., Agapova, M.V., Bogdashov, A.A., Denisov, G.G., Gnedenkov, A.Ph., Ilyin, V.I., Ilyin, V.N., Khmara, D.V., Kuftin, A.N., Litvak, A.G., Malygin, S.A., Malygin, V.I., Myasnikov, V.E., Nichiporenko, V.O., Pavelyev, A.B., Rischin, Yu.V., Shamanova, N.A., Solujanova, E.A., Tai, E.M., Usachev, S.V., Zapevalov, V.E., 2005, Status of multi-frequency 105-140 GHz/1 MW/10 s gyrotron and recent test results. Proc. 6th Int. Workshop on Strong Microwaves in Plasmas, Nizhny Novgorod, ed. A.G. Litvak, Inst. of Applied Physics, Russian Academy of Sciences, Nizhny Novgorod, 2006, **Vol. 1**, 119-124.

- [92] Denisov, G.G., Litvak, A.G., Myasnikov, V.E., Tai, E.M., Zapevalov, V.E., Agapova, M.V., Chirkov, A.V., Kuftin, A.N., Malygin, S.A., Malygin, V.I., Nichiporenko, V.O., Pavel'ev, A.B., Parshin, V.V., Soluyanov, E.A., Ilin, V.I., Ilin, V.N., Vikharev, A.L., Usachev, S.V., Usov, V.G., 2008, Development in Russia of high power gyrotrons for plasma fusion installations, Proc. 9th IEEE Int. Vacuum Electronics Conference (IVEC 2008), Monterey, CA, USA, 26-27.
- [93] Denisov, G.G., Litvak, A.G., Agapova, M.V., Myasnikov, V.E., Tai, E.M., Zapevalov, V.E., Chirkov, A.V., Kuftin, A.N., Malygin, S.A., Malygin, V.I., Nichiporenko, V.O., Kazansky, I.V., Kruglov, A.V., Rukavishikova, V.G., Knedenkov, A.F., Pavel'ev, A.B., Parsin, V.V., Popov, L.G., Sokolov, E.V., Soluyanov, E.A., Ilin, V.I., Ilin, V.N., Vikharev, A.L., Shamanova, N.A., Usachev, S.V., 2008, Multi-frequency gyrotrons for plasma fusion installations, Proc. 33rd Int. Conf. on Infrared, Millimeter and Terahertz Waves, Pasadena, CA, USA, T2A1.1468.
- [94] Litvak, A.G., 2008, High power gyrotrons: development and applications, Proc. 33rd Int. Conf. on Infrared, Millimeter and Terahertz Waves, Pasadena, CA, USA, R1P1.1734.
- [95] Denisov, G.G., Litvak, A.G., Myasnikov, V.E., Tai, E.M., Zapevalov, V.E., 2008, Development in Russia of high-power gyrotrons for fusion. Nucl. Fusion, **48**, 054007 (5pp).
- [96] Denisov, G.G., Litvak, A.G., Myasnikov, V.E., Tai, E.M., Ilin, V.I., Zapevalov, E.V., 2008, Gyrotrons for fusion research. State of the art and progress trends, Proc. 7th Int. Workshop on Strong Microwaves: Sources and Applications, Nizhny Novgorod, ed. A.G. Litvak, Inst. of Applied Physics, Russian Academy of Sciences, Nizhny Novgorod, 2009, **Vol. 1**, pp. 15-26.
- [97] Kazansky, I.V., Kruglov, A.V., Malygin, S.A., Orlov, V.B., Solujanova, E.A., Tai, E.M., Belousov, V.I., Chirkov, A.V., Denisov, G.G., Malygin, V.I., Pavel'ev, A.B., Sokolov, E.V., 2008, Step-tunable experimental gyrotrons at 75 GHz and 140 GHz ranges, Proc. 7th Int. Workshop on Strong Microwaves: Sources and Applications, Nizhny Novgorod, ed. A.G. Litvak, Inst. of Applied Physics, Russian Academy of Sciences, Nizhny Novgorod, 2009, **Vol. 1**, pp. 100-102.
- [98] Litvak, A.G., Denisov, G.G., Myasnikov, V.E., Tai, E.M., Azizov, E.A., Ilin, V.I., 2011, Development in Russia of megawatt power gyrotrons for fusion, J. of Infrared Milli Terahz Waves, **32**, 337-342.
- [99] Litvak, A.G., Denisov, G.G., Myasnikov, V.E., Tai, E.M., Sokolov, E.V., Ilin, V.I., 2012, Recent development results in Russia of megawatt power gyrotrons for plasma fusion installations. EPJ Web of Conferences, **32**, 04003/1-7.
Khvostenko, A.P., Denisov, G.G., Ilin, V.I., Khvostenko, P.P., Kochin, V.A., Malygin, V.I., Myasnikov, V.E., Popov, L.G., Soluyanov, E.A., Tai, E.M., Usachev, S.V., 2012, Test bench for ITER gyrotrons. Measurements of the RF power value during tests of the ITER-prototype gyrotrons. EPJ Web of Conferences, **32**, 04021/1-6.
- [100] Kajiwara, K., Oda, Y., Kasugai, A., Takahashi, K., Sakamoto, K., 2011, Development of dual-frequency gyrotron with triode magnetron injection gun. Applied Physics Express, **4**, 126001-1 (3 pages).
- [101] Oda, Y., Kajiwara, K., Takahashi, K., Sakamoto, K., 2012, Development of dual frequency gyrotron and high power test of EC components. EPJ Web of Conferences, **32**, 04004/1-8.
- [102] Sakamoto, K., Kajiwara, K., Oda, Y., Takahashi, K., Hayashi, K., Kobayashi, N., 2012, Progress of high power multi-frequency gyrotron development, 38th Int. Conf. on Infrared, Millimeter and Terahertz Waves (IRMMW-THz 2012), Wollongong, Australia, Sept 23-28, 2012, Tue-A-3-1.
- [103] Golubev, S.V., Razin, S.V., Semenov, V.E., Smirnov, A.N., Vodopyanov, A.V., Zorin, V.G., 1999, Sources of soft X-rays and multicharged ions based on ECR discharge in heavy gases sustained by high-power gyrotron radiation. Proc. 4th Int. Workshop on Strong Microwaves in Plasmas, Nizhny Novgorod, ed. A.G. Litvak, Inst. of Applied Physics, Russian Academy of Sciences, Nizhny Novgorod, 2000, **Vol. 1**, 347-355.

- [104] Golubev, S.V., Luchin, V.I., Razin, S.V., Salaschenko, N.N., Smirnov, A.N., Vodopyanov, A.V., Zorin, V.G., 1999, Mirror-trapped plasma heated by powerful millimeter wave radiation as an ECR source of soft X-rays. Proc. 4th Int. Workshop on Strong Microwaves in Plasmas, Nizhny Novgorod, ed. A.G. Litvak, Inst. of Applied Physics, Russian Academy of Sciences, Nizhny Novgorod, 2000, **Vol. 1**, 356-370.
- [105] Bohanov, A.F., Golubev, S.V., Izotov, I.V., Razin, S.V., Sidorov, A.V., Skalyga, V.A., Vodopyanov, A.V., Zorin, V.G., 2005, ECR ion source with quasi-gasdynamic plasma confinement regime. Proc. 6th Int. Workshop on Strong Microwaves in Plasmas, Nizhny Novgorod, ed. A.G. Litvak, Inst. of Applied Physics, Russian Academy of Sciences, Nizhny Novgorod, 2006, **Vol. 2**, 657-665.
- [106] Vodopyanov, A.V., Golubev, S.V., Mansfeld, D.A., Nikolaev, A.G., Oks, E.M., Khizhnyak, V.I., Yushkov, G.Yu., 2007, Multiple ionization of vacuum-arc-generated metal ions in a magnetic trap heated by high-power microwave radiation. Technical Physics, Letters, **33**, 44-49.
- [107] Ciavola, G., Gammino, S., Celona, L., 2008, ECR multicharged ion sources of new generation, Proc. 7th Int. Workshop on Strong Microwaves: Sources and Applications, Nizhny Novgorod, ed. A.G. Litvak, Inst. of Applied Physics, Russian Academy of Sciences, Nizhny Novgorod, 2009, **Vol. 2**, pp. 442-453.
- [108] Zorin, V.G., Bokhanov, A.F., Golubev, S.V., Izotov, I.V., Mansfeld, D.A., Razin, S.V., Sidorov, A.V., Skalyga, V.A., Vodopyanov, A.V., 2008, Gasdynamic ECR sources of multicharged ions, Proc. 7th Int. Workshop on Strong Microwaves: Sources and Applications, Nizhny Novgorod, ed. A.G. Litvak, Inst. of Applied Physics, Russian Academy of Sciences, Nizhny Novgorod, 2009, **Vol. 2**, pp. 587-591.
- [109] Higurashi, Y., Ohnishi, J., Nakagawa, T., Haba, H., Tamura, M., Aihara, T., Fujimaki, M., Komiyama, M., Uchiyama, A., Kamigaito, O., 2012, Production of a highly charged uranium ion beam with RIKEN superconducting electron cyclotron resonance ion source. Review of Scientific Instruments, **83**, 02A333 (3 pp).
- [110] Chkhalo, N.I., Golubev, S.V., Mansfeld, D., Salashchenko, N.N., Sjmaenok, L.A., Vodopyanov, A.V., 2012, Source for extreme ultraviolet lithography based on plasma sustained by millimeter-wave gyrotron radiation. J. Micro/Nanolith. MEMS MOEMS, **11**, 021123 (7 pp).
- [111] Flyagin, V.A., Kuftin, A.N., Luchinin, A.G., Nusinovich, G.S., Pankratova, T.B., Zapevalov, V.E., 1989, Gyrotrons for electron cyclotron heating and active plasma diagnostics. Proc. Joint IAEA Techn. Committee Meeting on ECE and ECRH (EC-7 Joint Workshop), Hefei, P.R. China, 355-372.
- [112] Flyagin, V.A., Luchinin, A.G., Nusinovich, G.S., 1983, Submillimeter-wave gyrotrons: theory and experiment. Int. J. Infrared and Millimeter Waves, **4**, 629-637.
- [113] Glyavin, M.Yu., Luchinin, A.G., 2007, A terahertz gyrotron with pulsed magnetic field, Radiophysics and Quantum Electronics, **50**, 755-761.
- [114] Glyavin, M.Yu., Luchinin, A.G., Golubiatnikov, G.Yu., 2008, Generation of 1.5-kW, 1-THz coherent radiation from a gyrotron with a pulsed magnetic field, Physical Review Letters, **100**, 015101-1 – 015102-3.
- [115] Glyavin, M.Yu., Luchinin, A.G., 2008, 1.3 THz gyrotron with a pulsed magnet, Proc. 7th Int. Workshop on Strong Microwaves: Sources and Applications, Nizhny Novgorod, ed. A.G. Litvak, Inst. of Applied Physics, Russian Academy of Sciences, Nizhny Novgorod, 2009, **Vol. 1**, pp. 108-116.
- [116] Glyavin, M.Yu., Luchinin, A.G., 2009, Powerful terahertz gyrotrons based on pulsed magnets. Terahertz Science and Technology, **2**, 150-155.
- [117] Bratman, V., Glyavin, M., Idehara, T., Kalynov, Y., Luchinin, A., Manuilov, V., Mitsudo, S., Ogawa, I., Saito, T., Tatematsu, Y., Zapevalov, V., 2009, Review of subterahertz and terahertz gyrodevices at IAP RAS and FIR FU, IEEE Trans. on Plasma Science, **37**, 36-43.

- [118] Bratman, V.L., Kalynov, Yu.K., Manuilov, V.N., 2009, Large-orbit gyrotron operation in the terahertz frequency range, *Physical Review Letters*, **102**, 245101-1 – 2045101-4.
- [119] Bratman, V.L., Glyavin, M.Yu., Kalynov, Yu.K., Litvak, A.G., Luchinin, A.G., Savilov, A.V., Zapevalov, V.E., 2011, Terahertz gyrotrons at IAP RAS: Status and new designs, *J. of Infrared Milli Terahz Waves*, **32**, 371-379.
- [120] Glyavin, M.Yu., Luchinin, A.G., 2011, High power pulsed terahertz gyrotrons, *Proc. 8th Int. Workshop Strong Microwaves and Terahertz Waves: Sources and Applications*, Nizhny Novgorod – St. Petersburg, Russia, July 9-16, 2011, pp. 59-60.
- [121] Bratman, V.L., Bogdashov, A.A., Denisov, G.G., Glyavin, M.Yu., Kalynov, Yu.K., Luchinin, A.G., Manuilov, V.N., Zapevalov, V.E., Zavolsky, N.A., Zorin, V.G., 2012, Gyrotron development for high power THz technologies at IAP RAS. *J. Infrared Milli Terahz Waves*, **33**, 715-723.
- [122] Idehara, T., Tatsukawa, T., Ogawa, I., Shimizu, Y., Nishida, N., Yoshida, K., 1996, Development and applications of submillimeter wave gyrotrons. *Proc. 3rd Int. Workshop on Strong Microwaves in Plasmas*, Nizhny Novgorod, 1997, **Vol.2**, 634-659.
- [123] Ogawa, I., Iwata, M., Idehara, T., Kawahata, K., Iguchi, H., Ejiri, A., 1997, Plasma scattering measurement using a submillimeter wave gyrotron (Gyrotron FUII) as a power source. *Fusion Engineering and Design*, **34-35**, 455-458.
- [124] Shimizu, Y., Ichikawa, K., Shibutani, K., Karuhashi, K., Tatsukawa, T., Idehara, T., Ogawa, I., Okazaki, Y., Okamoto, T., 1997, Submillimetre wave gyrotron (Gyrotron FU IV) for plasma diagnostics. *Fusion Engineering and Design*, **34-35**, 459-462.
- [125] Idehara, T., Ogawa, I., Mitsudo, S., Sabchevski, S., Kitai, A., Kitai, K., 2001, Development and applications of submillimeter wave gyrotrons (FU Series). *Proc. 9th Int. Conf. Displays and Vacuum Electronics*, Garmisch-Partenkirchen, ITG-Fachbericht **165**, 177-182.
- [126] Idehara, T., Kamada, M., Tsuchiya, H., Hayashi, T., Agusu, La, Mitsudo, S., Ogawa, I., Manuilov, V.N., Naito, K., Yuyama, T., Jiang, W., Yatsui, K., 2005, Development of THz gyrotrons in FIR FU. *Proc. 6th Int. Workshop on Strong Microwaves in Plasmas*, Nizhny Novgorod, ed. A.G. Litvak, Inst. of Applied Physics, Russian Academy of Sciences, Nizhny Novgorod, 2006, **Vol. 1**, 141-149.
- [127] Idehara, T., Saito, T., Ogawa, I., Mitsudo, S., Tatematsu, Y., 2008, THz gyrotrons – FU CW series for high power THz technologies, *Proc. 33rd Int. Conf. on Infrared, Millimeter and Terahertz Waves*, Pasadena, CA, USA, M2A3.1267.
- [128] Notake, T., Saito, T., Tatematsu, Y., Kubo, S., Shimozuma, T., Tanaka, K., Nishiura, M., Fujii, A., Agusu, L., Ogawa, I., Idehara, T., 2008, Subterahertz gyrotron developments for collective Thomson scattering in LHD. *Review of Scientific Instruments*, **79**, 10E732-1 – 10E732-3.
- [129] Idehara, T., Ogawa, I., Mitsudo, S., Tatematsu, Y., Saito, T., 2008, Development and applications of THz gyrotrons, *Proc. 7th Int. Workshop on Strong Microwaves: Sources and Applications*, Nizhny Novgorod, ed. A.G. Litvak, Inst. of Applied Physics, Russian Academy of Sciences, Nizhny Novgorod, 2009, **Vol. 1**, pp. 40-46.
- [130] Idehara, T., Ogawa, I., Mitsudo, S., Tatematsu, Y., Furuya, T., Saito, T., 2009, High power THz technologies using gyrotrons as radiation sources, *Proc. 34th Int. Conf. on Infrared, Millimeter and Terahertz Waves*, Busan, Korea, W3D01.0047.
- [131] Notake, T., Saito, T., Tatematsu, Y., Fujii, A., Ogasawara, S., La Augustu, Ogawa, I., Idehara, T., 2009, Development of a novel high power sub-THz second harmonic gyrotron, *Physical Review Letters*, 225002-1 – 225002-4.
- [132] Saito, T., Notake, T., Tatematsu, Y., Fujii, A., Ogasawara, S., Agusu, L., Idehara, T., Manuilov, V.N., 2009, Generation of high power sub terahertz radiation from a gyrotron at second harmonic resonance, *Proc. 34th Int. Conf. on Infrared, Millimeter and Terahertz Waves*, Busan, Korea, R4D05.0089.

- [133] Saito, T., Tatematsu, Y., Ogasawara, S., Yamada, N., Fujii, A., Idehara, T., Manuilov, V.N., 2010, Development of high power sub terahertz gyrotrons for application to CTS measurement, Proc. 35th Int. Conf. on Infrared, Millimeter and Terahertz Waves, Rome, Italy, Th-E1.5.
- [134] Idehara, T., Horii, F., Fujii, Y., Ogawa, I., Saito, T., Fujiwara, T., Suehara, T., Dupree, R., 2011, High power THz technologies opened by high power radiation sources – Gyrotron FU CW series, Proc. 8th Int. Workshop Strong Microwaves and Terahertz Waves: Sources and Applications, Nizhny Novgorod – St. Petersburg, Russia, July 9-16, 2011, Invited S1, pp. 61-62.
- [135] Saito, T., Tatematsu, Y., Yamada, N., Ogasawara, S., Ikeda, R., Ogawa, I., Idehara, T., Manuilov, V.N., 2011, Development of high power gyrotrons in the sub terahertz region for application to CTS measurement, Proc. 8th Int. Workshop Strong Microwaves and Terahertz Waves: Sources and Applications, Nizhny Novgorod – St. Petersburg, Russia, July 9-16, 2011, pp. 65-66.
- [136] Tatematsu, Y., Yamaguchi, Y., Idehara, T., Ozeki, T., Ikeda, R., Kanemaki, T., Ogawa, I., Saito, T., 2012, Development of a kW level-200 GHz gyrotron FU CW GI with an internal quasi-optical mode converter. *J. Infrared Milli Terahz Waves*, **33**, 292-305.
- [137] Saito, T., Ogasawara, S., Yamada, N., Ikeuchi, S., Tatematsu, Y., Ikeda, R., Ogawa, I., Manuilov, V.N., 2012, New power records of sub-terahertz gyrotron with second-harmonic oscillation. *Plasma and Fusion Research: Rapid Communications*, **7**, 126003-1 (3 pages).
- [138] Saito, T., Tatematsu, Y., Yamaguchi, Y., Ikeuchi, S., Ogasawara, S., Yamada, N., Ikeda, R., Ogawa, I., Idehara, T., 2012, Observation of dynamic interactions between fundamental and second-harmonic modes in a high-power sub-terahertz gyrotron operating in regimes of soft and hard self-excitation. *Physical Review Letters*, **109**, 155001-1 (5 pages).
- [139] Saito, T., Yamada, N., Ikeuchi, S., Ogasawara, S., Tatematsu, Y., Ikeda, R., Ogawa, I., Idehara, T., Manuilov, V.N., Shimozuma, T., Kubo, S., Nishiura, M., Tanaka, K., Kawahata, K., 2012, Generation of high power sub-terahertz radiation from a gyrotron with second harmonic oscillation. *Physics of Plasmas*, **19**, 063106 (9 pp).
- [140] Idehara, T., Sabchevski, S.P., 2012, Development and applications of high-frequency gyrotrons in FIR FU covering the sub-THz to THz range. *J. Infrared Milli Terahz Waves*, **33**, 667-694.
- [141] Idehara, T., Mudiganti, J.C., Agusu, L., Kanemaki, T., Ogawa, I., Fujiwara, T., Matsuki, Y., Ueda, K., 2012, Development of a compact sub-THz gyrotron FU CW CI for application to high power THz technologies. *J. Infrared Milli Terahz Waves*, **33**, 724-744.
- [142] Saito, T., Yamada, N., Ikeuchi, S., Ogasawara, S., Yamaguchi, Y., Tatematsu, Y., Ikeda, R., Ogawa, I., 2012, Mode competition and cooperation in high power sub-THz gyrotrons, 38th Int. Conf. on Infrared, Millimeter and Terahertz Waves (IRMMW-THz 2012), Wollongong, Australia, Sept 23-28, 2012, Tue-A-3-4.
- [143] Ikeda, R., Tatematsu, Y., Idehara, T., Yamaguchi, Y., Ogawa, I., Saito, T., 2012, Development of a table-top 200 GHz gyrotron FU CW CII with an internal mode converter, 38th Int. Conf. on Infrared, Millimeter and Terahertz Waves (IRMMW-THz 2012), Wollongong, Australia, Sept 23-28, 2012, Mon-C-3-5.
- [144] Yamaguchi, Y., Saito, T., Tatematsu, Y., Ikeuchi, S., Yamada, N., Ikeda, R., Ogawa, I., Idehara, T., 2012, Development of a high-power 295 GHz fundamental-harmonic gyrotron, 38th Int. Conf. on Infrared, Millimeter and Terahertz Waves (IRMMW-THz 2012), Wollongong, Australia, Sept 23-28, 2012, Tue-A-3-5.
- [145] Bajaj, V.S., Farrar, C.T., Hornstein, M.K., Mastovsky, I., Viereg, J., Bryant, J., Eléna, B., Kreisler, K.E., Temkin, R.J., Griffin, R.G., 2003, Dynamic nuclear polarization at 9 T using a novel 250 GHz gyrotron microwave source. *J. of Magnetic Resonance*, **160**, 85-90.
- [146] Hornstein, M.K., Bajaj, V.S., Griffin, R.G., Kreisler, K.E., Mastovsky, I., Shapiro, M.A., Sirigiri, J.R., Temkin, R.J., 2004, Harmonic results of a 460 GHz gyrotron. 5th IEEE Int. Vacuum Electronics Conf. (IVEC 2004), Monterey, CA, USA, 26-27.

- [147] Hornstein, M.K., Bajaj, V.S., Griffin, R.G., Kreischer, K.E., Mastovsky, I., Shapiro, M.A., Sirigiri, J.R., Temkin, R.J., Woskov, P.P., 2004, CW results of a 460 GHz second harmonic gyrotron oscillator – for sensitivity enhanced NMR –. Conf. Digest 29th Int. Conf. on Infrared and Millimeter Waves and 12th Int. Conf. on Terahertz Electronics, Karlsruhe, Germany, 147-148.
- [148] Hornstein, M.K., Bajaj, V.S., Kreischer, K.E., Griffin, R.G., Temkin, R.J., 2005, CW second harmonic results at 460 GHz of a gyrotron oscillator – for sensitivity enhanced NMR –. Conf. Digest 30th Int. Conf. on Infrared and Millimeter Waves and 13th Int. Conf. on Terahertz Electronics, Williamsburg, VA, USA, 437-438.
- [149] Hornstein, M.K., Bajaj, V.S., Griffin, R.G., Kreischer, K.E., Mastovsky, I., Shapiro, M.A., Sirigiri, J.R., Temkin, R.J., 2005, Second harmonic operation at 460 GHz and broadband continuous frequency tuning of a gyrotron oscillator. IEEE Trans. on Electron Devices, **52**, 798-807.
- [150] Han, S.T., Joye, C.D., Mastovsky, I., Shapiro, M.A., Sirigiri, J.R., Temkin, R.J., Woskov, P.P., 2006, Stable operation of a 0.46 THz continuous wave gyrotron oscillator. Proc. Int. Vacuum Electronics Conference and Int. Vacuum Electron Sources (IVEC/IVESC 2006), Monterey, California, USA, 539-540.
- [151] Joye, C.D., Griffin, R.G., Hornstein, M.K., Hu, K.N., Kreischer, K.E., Rosay, M., Shapiro, M.A., Sirigiri, J.R., Temkin, R.J., Woskov, P.P., 2006, Operational characteristics of a 14-W 140-GHz gyrotron for dynamic nuclear polarization. IEEE Trans. on Plasma Science, **PS-34**, 518-523.
- [152] Hornstein, M.K., Bajaj, V.S., Griffin, R.G., Temkin, R.J., 2006, Continuous-wave operation of a 460-GHz second harmonic gyrotron oscillator. IEEE Trans. on Plasma Science, **PS-34**, 524-533.
- [153] Hornstein, M.K., Bajaj, V.S., Griffin, R.G., Temkin, R.J., 2007, Efficient low-voltage operation of a CW gyrotron oscillator at 233 GHz. IEEE Trans. on Plasma Science, **PS-35**, 27-30.
- [154] Han, S.T., Griffin, R.G., Hu, K.N., Joo, C.-G., Joye, C.D., Sirigiri, J.R., Temkin, R.J., Torrezan, A.C., Woskov, P.O., 2007, Spectral characteristics of a 140 GHz long-pulsed gyrotron, IEEE Trans. on Plasma Science, **PS-35**, 559-564.
- [155] Bajaj, V.S., Hornstein, M.K., Kreischer, K.E., Sirigiri, J.R., Woskov, P.O., Mark-Jurkaskas, M.L., Herzfeld, J., Temkin, R.J., Griffin, R.G., 2007, 250 GHz CW gyrotron oscillator for dynamic nuclear polarization in biological solid state NMR, J. of Magnetic Resonance, **189**, 251-279.
- [156] Torrezan, A.C., Han, S.T., Shapiro, M.A., Sirigiri, J.R., Temkin, R.J., 2008, CW operation of a tunable 330/460 GHz gyrotron for enhanced nuclear magnetic resonance, Proc. 33rd Int. Conf. on Infrared, Millimeter and Terahertz Waves, Pasadena, CA, USA, T5D33.1271.
- [157] Torrezan, A.C., Han, S.-T., Mastovsky, I., Shapiro, M.A., Sirigiri, J.R., Temkin, R.J., Barnes, A.B., Griffin, R.G., 2010, Continuous-wave operation of a frequency-tunable 460-GHz second-harmonic gyrotron for enhanced nuclear magnetic resonance, IEEE Trans. on Plasma Science, **38**, 1150-1159.
- [158] Torrezan, A.C., Shapiro, M.A., Sirigiri, J.R., Temkin, R.J., 2010, Operation of a tunable second-harmonic 330 GHz CW gyrotron, Proc. 11th IEEE Int. Vacuum Electronics Conference (IVEC 2010), Monterey, USA, pp. 199-200.
- [159] Temkin, R., Barnes, A., Griffin, R., Jawla, S., Mastovsky, I., Nanni, E., Shapiro, M., Torrezan, A., Woskov, P., 2011, Recent progress at MIT on THz gyrotron oscillators for DNP/NMR, Proc. 36th Int. Conf. on Infrared, Millimeter and Terahertz Waves (IRMMW-THz 2011), Houston, TX, USA, W3A.1.
- [160] Barnes, A.B., Markhasin, E., Daviso, E., Michaelis, V.K., Nanni, E.A., Jawla, S.K., Mena, E.L., DeRocher, R., Thakkar, A., Woskov, P.P., Herzfeld, J., Temkin R.J., Griffin, R.G., 2012, Dynamic nuclear polarization at 700 MHz/460 GHz. J. of Magnetic Resonance, **224**, 1-7.

- [161] Barnes, A.B., Nanni, E.A., Herzfeld, J., Griffin, R.G., Temkin, R.J., 2012, A 250 GHz gyrotron with a 3 GHz tuning bandwidth for dynamic nuclear polarization. *J. of Magnetic Resonance*, **221**, 147-153.
- [162] Barnes, A.B., Nanni, E.A., Jawla, S., Ni, Q.Z., Herzfeld, J., Griffin, R.G., Temkin, R.J., 2012, A novel high power 3 GHz tunable 250 GHz gyrotron for dynamic nuclear polarization, Proc. 13th IEEE Int. Vacuum Electronics Conference and 9th IEEE Int. Vacuum Electron Sources Conference (IVEC-IVESC 2012), Monterey, CA, USA, pp. 329-330.
- [163] Jawla, S., Ni, Q.Z., Barnes, A., Guss, W., Daviso, E., Herzfeld, J., Griffin, R., Temkin, R., 2013, Continuously tunable 250 GHz gyrotron with a double disk window for DNP-NMR spectroscopy. *J. Infrared Milli Terahz Waves*, **34**, 42-52.
- [164] Blank, M., Borchard, P., Cahalan, P., Cauffman, S., Felch, K., Rosay, M., Tometich, L., 2009, Demonstration of a 263 GHz gyrotron for dynamic nuclear polarization, Proc. 34th Int. Conf. on Infrared, Millimeter and Terahertz Waves, Busan, Korea, W3D02.0122.
- [165] Rosay, M., Tometich, L., Pawsey, S., Bader, R., Schauwecker, R., Blank, M., Borchard, P.M., Cauffman, S.R., Felch, K.L., Weber, R.T., Temkin, R.J., Griffin, R.G., Maas, W.E., 2010, Solid-state dynamic nuclear polarization at 263 GHz: Spectrometer design and experimental results, *Phys. Chem. Chem. Phys.*, **12**, 5850-5860.
- [166] Blank, M., Borchard, P., Cauffman, S., Felch, K., Rosay, M., Tometich, L., 2012, High-frequency CW gyrotrons for NMR/DNP applications, Proc. 13th IEEE Int. Vacuum Electronics Conference and 9th IEEE Int. Vacuum Electron Sources Conference (IVEC-IVESC 2012), Monterey, CA, USA, pp. 327-328.
- [167] Booske, J.H., Dobbs, R.J., Joye, C.D., Kory, C.L., Neil, G.R., Park, G.S., Park, J., Temkin, R.J., 2011, Vacuum electronic high power terahertz sources, *IEEE Trans. on Terahertz Science and Technology*, **1**, 54-75.
- [168] Nusinovich, G., 2011, Terahertz gyrotrons, Proc. 36th Int. Conf. on Infrared, Millimeter and Terahertz Waves (IRMMW-THz 2011), Houston, TX, USA, W1.1.
- [169] Idehara, T., Ogawa, I., Agusu, La., Kanemaki, T., Mitsudo, S., Saito, T., Fujiwara, T., Takahashi, H., 2007, Development of 394.6 GHz CW gyrotron (gyrotron FU CW II) for DNP/Proton-NMR at 600 MHz. *Int. J. Infrared and Millimeter Waves*, **28**, 433-442.
- [170] Agusu, La, Idehara, T., Ogawa, I., Saito, T., Kanemaki, T., Takahashi, H., Fujiwara, T., 2007, Detailed consideration of experimental results of gyrotron FU CW II developed as a radiation source for DNP-NMR spectroscopy. *Int. J. Infrared and Millimeter Waves*, **28**, 499-511.
- [171] Idehara, T., Ogawa, I., Agusu, L., Kanemaki, T., Mitsudo, S., Saito, T., Fujiwara, T., Takahashi, H., 2007, Development of 394.6 GHz CW gyrotron (gyrotron FU CW II) for DNP/Proton-NMR at 600 MHz. *Int. J. Infrared and Millimeter Waves*, **28**, 433-442.
- [172] Agusu, L., Idehara, T., Ogawa, I., Saito, T., Kanemaki, T., Takahashi, H., Fujiwara, T., 2007, Detailed consideration of experimental results of gyrotron FU CW II developed as a radiation source for DNP-NMR spectroscopy. *Int. J. Infrared and Millimeter Waves*, **28**, 499-511.
- [173] Idehara, T., Saito, T., Ogawa, I., Mitsudo, S., Tatematsu, Y., La Agusu, Mori, H., Kobayashi, S., 2008, Development of terahertz FU CW gyrotron series for DNP, *Appl. Magn. Reson.*, **34**, 265-275.
- [174] Idehara, T., Agusu, L., Ogawa, I., Kobayashi, S., Saito, T., Dupree, R., Smith, M.E., 2008, Development of gyrotron FU CW IIA for 600 MHz and 300 MHz DNP-NMR experiments at the University of Warwick, Proc. 33rd Int. Conf. on Infrared, Millimeter and Terahertz Waves, Pasadena, CA, USA, T5D23.1185.
- [175] Kosuga, K., Idehara, T., Ogawa, I., Saito, T., Agusu, L., Kanemaki, T., Smith, M.E., Dupree, R., 2009, Development of Gyrotron FU CW VII for 600 and 300 MHz DNP-NMR, Proc. 34th Int. Conf. on Infrared, Millimeter and Terahertz Waves, Busan, Korea, M5E55.0235.

- [176] Ogawa, I., Idehara, T., Kobayashi, S., Chang, T.H., Horii, F., Saito, T., 2009, Development of continuously frequency tunable gyrotron and its application to 200 MHz DNP-NMR spectroscopy as a radiation source, Proc. 34th Int. Conf. on Infrared, Millimeter and Terahertz Waves, Busan, Korea, W3D03.0309.
- [177] Idehara, T., Kosuga, K., Agusu, L., Ikeda, R., Ogawa, I., Saito, T., Matsuki, Y., Ueda, K., Fujiwara, T., 2010, Continuously frequency tunable high power sub-THz radiation source – gyrotron FU CW VI for 600 MHz DNP-NMR spectroscopy, J. Infrared Milli Terahz Waves, **31**, 775-790.
- [178] Idehara, T., Kosuga, K., La Agusu, Ogawa, I., Dupree, R., Takahashi, H., Mark, M.E., 2010, Gyrotrons FU CW VII for 600 MHz and 300 MHz DNP-NMR spectroscopy, Proc. 35th Int. Conf. on Infrared, Millimeter and Terahertz Waves, Rome, Italy, We-P13.
- [179] Mitsudo, S., Nakagawa, N., Ohashi, Y., Katayama, T., Tatematsu, Y., Ogawa, I., Idehara, T., Saito, T., 2010, Development of a sub-THz CW gyrotron for the millimeter wave pulsed ESR spectrometer, Proc. 35th Int. Conf. on Infrared, Millimeter and Terahertz Waves, Rome, Italy, Th-P.53.
- [180] Idehara, T., Saito, T., Ogawa, I., Mitsudo, S., Tatematsu, Y., Ikeda, R., Mudiganti, J., Kosuga, K., 2010, THz gyrotron FU CW series for high power THz technologies, Proc. 35th Int. Conf. on Infrared, Millimeter and Terahertz Waves, Rome, Italy, Th-E1.1.
Urushizaki, Y., Idehara, T., Ogawa, I., Ikeda, R., Sabchevski, S., Asai, S., Suehara, T., Miyazaki, A., Yamazaki, T., Kobayashi, T., 2010, Gyrotrons FU CW V and FU CW VIII for measurement of hyperfine structure of positronium, Proc. 35th Int. Conf. on Infrared, Millimeter and Terahertz Waves, Rome, Italy, Mo-P.31.
- [181] Ikeda, R., Idehara, T., Ogawa, I., Kosuga, K., Saito, T., Matsuki, Y., Ueda, K., Fujiwara, T., Chang, T.H., 2010, Development of continuously frequency tunable gyrotrons FU, CW VI and FU CW VI A for application to 600 MHz DNP-NMR spectroscopy, Proc. 35th Int. Conf. on Infrared, Millimeter and Terahertz Waves, Rome, Italy, Th-E1.3.
- [182] Idehara, T., Kosuga, K., Agusu, L., Ikeda, R., Ogawa, I., Saito, T., Matsuki, Y., Ueda, K., Fujiwara, T., 2010, Continuously frequency tunable high power sub-THz radiation source-gyrotron FU CW VI for 600 MHz DNP-NMR spectroscopy, J. Infrared Milli Terahz Waves, **31**, 775-790.
- [183] Matsuki, Y., Takahashi, H., Ueda, K., Idehara, T., Ogawa, I., Toda, M., Akutsu, H., Fujiwara, T., 2010, Dynamic nuclear polarization experiments at 14.1 T for solid-state NMR, Phys. Chem. Chem. Phys., **12**, 5799-5803.
- [184] Matsuki, Y., Ueda, K., Idehara, T., Ikeda, R., Ogawa, I., Nakamura, S., Toda, M., Anai, T., Fujiwara, T., 2012, Helium-cooling and μ -spinning dynamic nuclear polarization for sensitivity-enhanced solid-state NMR at 14 T and 30 K. J. of Magnetic Resonance, **225**, 1-9.
- [185] Matsuki, Y., Ueda, K., Idehara, T., Ikeda, R., Kosuga, K., Ogawa, I., Nakamura, S., Toda, M., Anai, T., Fujiwara, T., 2012, Application of continuously frequency-tunable 0.4 THz gyrotron to dynamic nuclear polarization for 600 MHz solid-state NMR. J. Infrared Milli Terahz Waves, **33**, 745-755.
- [186] Ikeda, R., Idehara, T., Ogawa, I., Tatematsu, Y., Chang, T.H., Chen, N.C., Matsuki, Y., Ueda, K., Fujiwara, T., 2012, Development of a continuously frequency tunable gyrotron operating at the fundamental resonance for 600 MHz DNP-NMR spectroscopy, 38th Int. Conf. on Infrared, Millimeter and Terahertz Waves (IRMMW-THz 2012), Wollongong, Australia, Sept 23-28, 2012, Tue-Pos-29.
- [187] Dumbrajs, O., Idehara, T., 2010, Frequency tunable gyrotron FU CW VA for measuring hyperfine split of positronium, J. Infrared Milli Terahz Waves, **31**, 1265-1270.
- [188] Yamazaki, T., Miyazaki, A., Suehara, T., Namba, T., Asai, S., Kobayashi, T., Saito, H., Ogawa, I., Idehara, T., Sabchevski, S., 2012, Direct observation of the hyperfine transition of ground-state positronium. Physical Review Letters, **108**, 253401, 5 (pp).

- [189] Asai, S., Yamazaki, T., Miyazaki, A., Suehara, T., Namba, T., Kobayashi, T., Saito, H., Idehara, T., Ogawa, I., Sabchevski, S., 2012, Direct measurement of positronium hyperfine structure: ~ A new horizon of precision spectroscopy using gyrotrons ~. *J. Infrared Milli Terahz Waves*, **33**, 766-776.
- [190] Rogalev, A., Goulon, J., Goujon, G., Wilhelm, F., Ogawa, I., Idehara, T., 2012, X-ray detected magnetic resonance at sub-THz frequencies using a high power gyrotron source. *J. Infrared Milli Terahz Waves*, **33**, 777-793.
- [191] Glyavin, M., Idehara, T., Khizhnyak, V., Luchinin, A., Manuilov, V., Agusu, L., Ogawa, I., Saito, T., Takahashi, H., Fujiwara, T., 2008, Design of gyrotron FU CW VI for 600 MHz DNP-NMR experiment, Proc. 33rd Int. Conf. on Infrared, Millimeter and Terahertz Waves, Pasadena, CA, USA, T5D28.1432.
- [192] Zapevalov, V.E., Dubrov, V.V., Fix, A.Sh., Kopelovich, E.A., Kuftin, A.N., Malygin, O.V., Manuilov, V.N., Moiseev, M.A., Sedov, A.S., Venediktov, N.P., Zavolsky, N.A., 2009, Development of 260 GHz second harmonic CW gyrotron with high stability of output parameters for DNP spectroscopy, Proc. 34th Int. Conf. on Infrared, Millimeter and Terahertz Waves, Busan, Korea, W3D04.0389.
- [193] Glyavin, M.Yu., Luchinin, A.G., Rodin, Yu.V., 2010, Generation of 5 kW/l THz coherent radiation from pulsed magnetic field gyrotron, Proc. 35th Int. Conf. on Infrared, Millimeter and Terahertz Waves, Rome, Italy, We-E1.1.
- [194] Zapevalov, V.E., Fix, A.Sh., Kopelovich, E.A., Kornishin, S.Yu., Kotov, A.V., Kuftin, A.N., Malygin, O.V., Manuilov, V.N., Moiseev, M.A., Sedov, A.S., Tsalolikhin, V.I., Zavolsky, N.A., 2010, Elaboration of 260 GHz second harmonic CW gyrotron with high stability of output parameters for DNP spectroscopy, Proc. 35th Int. Conf. on Infrared, Millimeter and Terahertz Waves, Rome, Italy, We-E1.4.
- [195] Denysenkov, V., Prandolini, M.J., Gafurov, M., Sezer, D., Endeward, B., Prisner, T.F., 2010, Liquid state DNP using a 260 GHz high power gyrotron, *Phys. Chem. Chem. Phys.*, **12**, 5786-5790.
- [196] Alberti, S., Ansermet, J.Ph., Braunmüller, F., Cuanillon, P., Dubray, J., Fasel, D., Hogge, J.Ph., Macor, A., de Rijk, E., Tran, M.Q., Tran, T.M., Vuillemin, Q., 2012, Experimental results on a modular gyrotron operating at 0.26 THz for 400 MHz DNP/NMR spectroscopy applications, 38th Int. Conf. on Infrared, Millimeter and Terahertz Waves (IRMMW-THz 2012), Wollongong, Australia, Sept 23-28, 2012, Thu-A-2-3.
- [197] Glyavin, M.Yu., Luchinin, A.G., Nusinovich, G.S., Rodgers, J., Kashyn, D.G., Romero-Talamas, C.A., Pu, R., 2012, A 670 GHz gyrotron with record power and efficiency. *Applied Physics Letters*, **101**, 153503 (4 pages).
- [198] Glyavin, M., Luchinin, A., Morozkin, M., Bogdashov, A., Rodin, Yu., Denisov, G., Rodgers, J., Romero-Talamas, C., Kashyn, D., Pu, R., Nusinovich, G., Shkvarunets, A., Granatsein, V., 2012, Experimental investigation of powerful 0.67 THz gyrotron with a pulsed solenoid for remote detection of concealed radioactive materials, 38th Int. Conf. on Infrared, Millimeter and Terahertz Waves (IRMMW-THz 2012), Wollongong, Australia, Sept 23-28, 2012, Mon-A-3-4.
- [199] Tatsukawa, T., Doi, A., Teranaka, M., Takashima, H., Goda, F., Watanabe, S., Idehara, T., Mitsudo, S., Kanemaki, T., Namba, T., 2005, Millimeter wave irradiation and invasion into living bodies using a gyrotron as a radiation source. Proc. 6th Int. Workshop on Strong Microwaves in Plasmas, Nizhny Novgorod, ed. A.G. Litvak, Inst. of Applied Physics, Russian Academy of Sciences, Nizhny Novgorod, 2006, **Vol. 2**, 727-731.
- [200] Miyoshi, N., Ito, S., Ogawa, I., Idehara, T., 2010, Combination treatment of hyperthermia and photodynamic for experimental tumor model using gyrotron (107, 203 GHz), Proc. 35th Int. Conf. on Infrared, Millimeter and Terahertz Waves, Rome, Italy, Th-P.11.
- [201] Sabchevski, S.P., Idehara, T., Ishiyama, S., Miyoshi, N., Tatsukawa, T., 2013, A dual-beam irradiation facility for a novel hybrid cancer therapy. *J. Infrared Milli Terahz Waves*, **34**, 71-87.

- [202] Bykov, Y., Goldenberg, A.F.L., Flyagin, V.A., 1991, The possibilities of material processing by intense millimeter-wave radiation. *Mat. Res. Soc. Symp. Proc.*, **169**, 41-42.
- [203] Sklyarevich, V., Detkov, A., Shevelev, M., Decker, R., 1992, Interaction between gyrotron radiation and powder materials. *Mat. Res. Soc. Symp. Proc.*, **269**, 163-169.
- [204] Link, G., Feher, L., Rhee, S., Thumm, M., Bauer, W., Ritzhaupt-Kleissl, H.-H., Weddigen, A., Böhme, R., Weisenburger, A., 1998, Sintering of ceramics using gyrotron radiation. *Proc. 8th ITG-Conference on Displays and Vacuum Electronics, Garmisch-Partenkirchen, ITG-Fachbericht* **150**, 375-380.
- [205] Link, G., Feher, L., Thumm, M., Ritzhaupt-Kleissl, H.-J., Böhme, R., Weisenburger, A., 1999, Sintering of advanced ceramics using a 30 GHz, 10 kW, CW industrial gyrotron. *IEEE Trans. on Plasma Science*, **PS-27**, 547-554.
- [206] Link, G., Weisenburger, A., Thumm, M., 2004, Millimeter-wave technology for powder processing. *Proc. 10th Int. Conf. Displays and Vacuum Electronics, Garmisch-Partenkirchen, ITG-Fachbericht* **183**, 311-315.
- [207] Mitsudo, S., Sakai, K., Idehara, T., Saji, T., Saito, T., Sano, S., 2007, Millimeter and submillimeter wave sintering of ceramics. *Conf. Digest 32nd Int. Conf. on Infrared and Millimeter Waves and 15th Int. Conf. on Terahertz Electronics, Cardiff, UK*, 267-268.
- [208] Mitsudo, S., Hoshizuki, H., Idehara, T., Saito, T., 2006, Development of material processing system by using a 300 GHz CW gyrotron. *Journal of Physics. Conference Series*, **51**, 549-552.
- [209] Denisov, G., Bykov, Yu., Ereemeev, A., Glyavin, M., Kholoptsev, V., Kalynova, G., Luchinin, A., Morozkin, M., Plotnikov, I., Sobolev, D., 2007, High efficient gyrotron-based systems for materials processing, *Proc. 8th IEEE Int. Vacuum Electronics Conference (IVEC 2007), Kitakyushu, Japan*, 433-434.
- [210] Vikharev, A.L., Gorbachev, A.M., Kozlov, A.V., Koldanov, V.A., Litvak, A.G., Ovechkin, N.M., Bykov, Yu.V., Denisov, G.G., Parshin, V.V., Radishev, D.B., 2005, Development of MPACVD technology for high-rate diamond production. *Proc. 6th Int. Workshop on Strong Microwaves in Plasmas, Nizhny Novgorod, ed. A.G. Litvak, Inst. of Applied Physics, Russian Academy of Sciences, Nizhny Novgorod, 2006, Vol. 2*, 613-625.
- [211] Vikharev, A.L., Gorbachev, A.M., Kozlov, A.V., Koldanov, V.A., Litvak, A.G., Ovechkin, N.M., Radishev, D.B., Bykov, Yu.V., Chaplan, M., 2006, Diamond films grown by millimeter wave plasma-assisted CVD reactor, *Diamond and Related Materials*, **15**, 502-507.
- [212] Denisov, G.G., Bykov, Y.V., Glyavin, M.Yu., Luchinin, A.G., Morozkin, M.M., Sobolev, D.I., 2008, High efficient gyrotron-based systems for technological applications, *Proc. 33rd Int. Conf. on Infrared, Millimeter and Terahertz Waves, Pasadena, CA, USA, R4A2.1512*.
- [213] Denisov, G.G., Bykov, Yu.V., Ereemeev, A.G., Glyavin, M.Yu., Luchinin, A.G., Morozhin, M.M., Samsonov, S.V., 2009, Prospective gyro-devices for technological applications, *Proc. 10th IEEE Int. Vacuum Electronics Conference (IVEC 2009), Rome, Italy*, pp. 513-514.
- [214] Bykov, Y.V., Denisov, G.G., Ereemeev, A.G., Flat, F.A., Glyavin, M.Yu., Gorbachev, A.M., Kalynova, G.I., Kholoptsev, V.V., Kopelovich, E.A., Luchinin, A.G., Plotnikov, I.V., Morozkin, M.V., Samsonov, S.V., Vikharev, A.L., 2009, Efficiency enhancement of gyrotron based setups for materials processing, *Proc. 34th Int. Conf. on Infrared, Millimeter and Terahertz Waves, Busan, Korea, R3D03.0058*.
- [215] Soluyanov, E.A., Bykov, Yu.V., Chirkov, A.V., Denisov, G.G., Kopelovich, E.A., Orlov, V.B., Pavelyev, A.B., Sokolov, E.V., Tai, E.M., 2011, Gyrotron complexes for technological applications, *Proc. 8th Int. Workshop Strong Microwaves and Terahertz Waves: Sources and Applications, Nizhny Novgorod – St. Petersburg, Russia, July 9-16, 2011*, p. 133.
- [216] Kikunaga, T., Asano, H., Yasojima, Y., Sato, F., Tsukamoto, T., 1995, A 28 GHz gyrotron with a permanent magnet system. *Int. J. Electronics*, **79**, 655-663.

- [217] Bykov, Yu., Glyavin, M., Goldenberg, A., Flyagin, V., Lygin, V., Manuilov, V., Moiseev, M., Zavolsky, N., 1999, Development and experimental investigation of high power technological gyrotrons. Conf. Digest 24th Int. Conf. on Infrared and Millimeter Waves, Monterey, California, USA, TU-A7.
- [218] Kuftin, A.N., Flyagin, V.A., Lygin, V.K., Luchinin, A.G., Malygin, O.V., Zapevalov, V.E., Zavolsky, N.A., 1999, 5.8-62 GHz CW gyrotrons with warm and permanent magnets for technological application. Proc. 4th Int. Workshop on Strong Microwaves in Plasmas, Nizhny Novgorod, ed. A.G. Litvak, Inst. of Applied Physics, Russian Academy of Sciences, Nizhny Novgorod, 2000, **Vol. 2**, 671- 676.
- [219] Kuftin, A.N., Flyagin, V.A., Lygin, V.K., Malygin, O.V., Zapevalov, V.E., Zavolsky, N.A., 1999, Technological gyrotrons with permanent magnet system. Proc. Int. University Conf. "Electronics and Radiophysics of Ultra-High Frequencies" (UHF-99), 1999, St. Petersburg, Russia, 126-129.
- [220] Kuftin, A.N., Flyagin, V.A., Lygin, V.K., Malygin, O.V., Zapevalov, V.E., Zavolsky, N.A., 2000, Technological gyrotrons with permanent magnet system. Conf. Digest 25th Int. Conf. on Infrared and Millimeter Waves, Beijing, P.R. China, 267-268.
- [221] Bykov, Yu., Denisov, G., Ereemeev, A., Kalynova, G., Kholoptsev, V., Kopelovich, E., Kuftin, A., Lygin, V., Pavelyev, A., Plotnikov, I., Zapevalov, V., Zavolsky, N., 2004, Microwave source based on the 24 GHz 3 kW gyrotron with permanent magnet. Conf. Digest 29th Int. Conf. on Infrared and Millimeter Waves and 12th Int. Conf. on Terahertz Electronics, Karlsruhe, Germany, 191-192.
- [222] Denisov, G., Bykov, Yu., Ereemeev, A., Kholoptsev, V., Glyavin, M., Luchinin, A., Kalynova, G., Plotnikov, I., 2006, 24-28 GHz gyrotron-based sources for technological applications. Conf. Digest 31st Int. Conf. on Infrared and Millimeter Waves and 14th Int. Conf. on Terahertz Electronics, Shanghai, China, 500.
- [223] Granatstein, V.L., Lawson, W., Latham, P.E., 1988, Feasibility of 30 GHz gyrokystron amplifiers for driving linear supercolliders. Conf. Digest, 13th Int. Conf. on Infrared and Millimeter Waves, Honolulu, Hawaii, Proc., SPIE **1039**, 230-231.
- [224] Granatstein, V.L., Nusinovich, G.S., 1993, On the optimal choice of microwave systems for driving TeV linear colliders. Proc. 2nd Int. Workshop on Strong Microwaves in Plasmas, Moscow - Nizhny Novgorod - Moscow, ed. A.G. Litvak, Inst. of Applied Physics, Nizhny Novgorod, 1994, **Vol. 2**, 575-586.
- [225] Granatstein, V.L., Lawson, W., 1996, Gyro-amplifiers as candidate RF drivers for TeV linear colliders. IEEE Trans. on Plasma Science, **PS-24**, 648-665.
- [226] Manheimer, W.M., Mesyats, G.A., Petelin, M.I., 1993, Super-high-power microwave radars. Proc. 2nd Int. Workshop on Strong Microwaves in Plasmas, Moscow - Nizhny Novgorod - Moscow, ed. A.G. Litvak, Inst. of Applied Physics, Nizhny Novgorod, 1994, **Vol. 2**, 632-641.
- [227] Manheimer, W.M., 1992, On the possibility of high power gyrotrons for super range resolution radar and atmospheric sensing. Int. J. Electronics, **72**, 1165-1189.
- [228] Clunie, D., Mesyats, G., Osipov, M.L., Petelin, M.I., Zagulov, P., Korovin, S.D., Clutterbuck, C.F., Wardrop, B., 1996, The design, construction and testing of an experimental high power, short-pulse radar. Proc. 3rd Int. Workshop on Strong Microwaves in Plasmas, Nizhny Novgorod, 1997, **Vol. 2**, 886-902.
- [229] Danly, B.G., Blank, M., Calame, J.P., Levush, B., Nguyen, K., Pershing, D., Petillo, J., Hargreaves, T.A., True, R.B., Theiss, A.J., Good, G.R., Felch, K., James, B.G., Borchard, P., Chu, T.S., Jory, H., Lawson, W.G., Antonsen, T.M., Garven, M., 1999, High average power gyrokystrons for radar applications. Conf. Digest 24th Int. Conf. on Infrared and Millimeter Waves, Monterey, California, USA, Plenary M-3.

- [230] Danly, B.G., 2002, Gyro-amplifiers for high power millimeter wave radar. Proc. 3rd IEEE Int. Vacuum Electronics Conf. (IVEC 2002), Monterey, USA, 361-362.
 Ngo, M.T., Danly, B.G., Myers, R., Pershing, D.E., Gregers-Hansen, V., Linde, G., 2002, High-power millimeter-wave transmitter for the NRL WARLOC radar. Proc. 3rd IEEE Int. Vacuum Electronics Conf. (IVEC 2002), Monterey, USA, 363-364.
- [231] Danly, B.G., Cheung, J., Gregers-Hansen, V., Linde, G., Ngo, M., 2002, Warloc: a high-power millimeter-wave radar. Proc. 27th Int. Conf. on Infrared and Millimeter Waves, San Diego, USA, 233-234.
- [232] Blank, M., Borchard, P., Cauffman, S., Felch, K., 2007, Design and demonstration of W-band gyrotron amplifiers for radar applications. Conf. Digest 32nd Int. Conf. on Infrared and Millimeter Waves and 15th Int. Conf. on Terahertz Electronics, Cardiff, UK, 364-366.
- [233] Linde, G.J., Ngo, M.T., Danly, B.G., Cheung, W.J., Hregers-Hansen, V., 2008, WARLOC: a high-power coherent 94 GHz radar, IEEE Trans. on Aerospace and Electronic Systems, **44**, 1102-1117.
- [234] Tolkachev, A.A., Levitan, B.A., Solovjev, G.K., Veytsel, V.V., Farber, V.E., July 2000, A megawatt power millimeter-wave phased-array radar. IEEE AES Systems Magazine, 25-31.
- [235] Tolkachov, A.A., Levitan, B.A., Petelin, M.I., 2008, Prospects of high-power millimeter-wave radar, Proc. 7th Int. Workshop on Strong Microwaves: Sources and Applications, Nizhny Novgorod, ed. A.G. Litvak, Inst. of Applied Physics, Russian Academy of Sciences, Nizhny Novgorod, 2009, **Vol. 2**, pp. 489-493.
- [236] Bratman, V.L., Denisov, G.G., Ginzburg, N.S., and Petelin, M.I., 1983, FEL's with Bragg reflection resonators. Cyclotron autoresonance masers versus ubitrons. I.E.E.E. Journal Quantum Electronics, **QE-19**, 282-296.
- [237] Marshall, T.C., 1985, Free electron lasers, MacMillan, New York.
- [238] Sprangle, P., Coffey, T., 1985, New high power coherent radiation sources, in Infrared and Millimeter Waves, **Vol. 13**, ed. K.J. Button, Academic Press, New York, 19-44.
- [239] Stone, R.R., Jong, R.A., Orzechowski, T.J., Scharlemann, E.T., Throop, A.L., Kulke, B., Thomassen, K.I., Stallard, B.W., 1990, An FEL-based microwave system for fusion. J. Fusion Energy, **9**, 77-101.
- [240] Freund, H.P., Antonsen, T.M., Jr., 1996, Principles of free-electron lasers. Chapman & Hall, London, 2nd edition.
- [241] Freund, H.P., Neil, G.R., 1999, Free-electron lasers: Vacuum electronic generators of coherent radiation. Proc. of the IEEE, **87**, 782-803.
- [242] Twiss, R.Q., 1958, Radiation transfer and the possibility of negative absorption in radio astronomy. Aust. J. Phys., **11**, 564-579; Twiss, R.Q., Roberts, J.A., 1958, Electromagnetic radiation from electrons rotating in an ionized medium under the action of a uniform magnetic field. Aust. J. Phys., **11**, 424.
- [243] Schneider, J., Stimulated emission of radiation by relativistic electrons in a magnetic field. 1959, Phys. Rev. Lett., **2**, 504-505.
- [244] Gaponov, A.V., Addendum, 1959, Izv. VUZ Radiofiz., **2**, 837, an addendum to Gapanov, A.V., 1959, Interaction between electron fluxes and electromagnetic waves and waveguides. Izv. VUZ Radiofiz., **2**, 450-462.
- [245] Kleinwächter, H., 1950, Zur Wanderfeldröhre. Elektrotechnik, **4**, 245-246 (in German).
- [246] Bott, I.B., 1964, Tunable source of millimeter and submillimeter electromagnetic radiation. Proc. of the IEEE, **52**, 330.
- [247] Bott, L.B., 1965, A powerful source of millimetre wavelength electromagnetic radiation. Physics Letters, **14**, 293-294.
- [248] Hirshfield, J.L., Wachtel, J.M., 1964, Electron cyclotron maser. Phys. Rev. Lett., **12**, 533-536.

- [249] Gaponov, A.V., Petelin, M.I. and Yulpatov, V.K., 1967, The induced radiation of excited classical oscillators and its use in high frequency electronics. *Izv. VUZ Radiofiz.* **10**, 1414 (*Radiophys. Quantum Electr.*, **10**, 794-813).
- [250] Jory, H., 1968, Investigation of electronic interaction with optical resonators for microwave generation and amplification. Research and Development Techn. Report ECOM-01873-F, Varian Associates, Palo Alto, California.
- [251] Granatstein, V.L., Alexeff, I., eds., 1987, High-power microwave sources. Artech House, Boston, London.
- [252] Benford, J. Swegle, J., Schamiloglu, E., 2007, High-power microwaves, 2nd Ed., Taylor & Francis, New York, London.
- [253] Nusinovich, G.S., 1999, Review of the theory of mode interaction in gyrodevices. *IEEE Trans. on Plasma Science*, **PS-27**, 313-326.
- [254] Edgcombe, C.J., ed., 1993, Gyrotron oscillators-their principles and practice. Taylor & Francis, London.
- [255] Kartikeyan, M.V., Borie, E., Thumm, M.K.A., 2004, Gyrotrons – High power microwave and millimeter wave technology. Springer, Berlin.
- [256] Nusinovich, G., 2004, Introduction to the physics of gyrotrons. The Johns Hopkins University Press, Baltimore and London.
- [257] Bogdashov, A.A., and Denisov, G.G., 2004, Asymptotic theory of high-efficiency converters of higher-order waveguide modes into eigenwaves of open mirror lines. *Radiophys. and Quantum Electr.*, **47**, 283-296.
- [258] Thumm, M., Arnold, A., Dammertz, G., Michel, G., Pretterebner, J., Wagner, D., Yang, X., 2004, An advanced dimple-wall launcher for a 140 GHz 1MW continuous wave gyrotron. *Proc. 10th Int. Conf. Displays and Vacuum Electronics*, Garmisch-Partenkirchen, ITG-Fachbericht **183**, 195-200.
- [259] Thumm, M., Yang, X., Arnold, A., Dammertz, G., Michel, G., Pretterebner, J., Wagner, D., 2005, A high-efficiency quasi-optical mode converter for a 140-GHz 1-MW CW gyrotron. *IEEE Trans. on Electron Devices*, **52**, 818-824.
- [260] Thumm, M., Arnold, A., Drumm, O., Jin, J., Michel, G., Piosczyk, B., Rzesnicki, T., Wagner, D., Yang, X., 2005, Quasi-optical mode converters in advanced high-power gyrotrons for nuclear fusion plasma heating. In: *Quasi-Optical Control of Intense Microwave Transmission*, eds. J.L. Hirshfield and M.I. Petelin, Springer, 325-351.
- [261] Chirkov, A.V., Denisov, G.G., Kulygin, M.L., Malygin, V.I., Malygin, S.A., Pavel'ev, A.B., Soluyanov, E.A., 2006, Use of Huygens's principle for analysis and synthesis of the fields in oversized waveguides, *Radiophys. Quantum Electron.*, **49**, 344-353.
- [262] Jin, J., Thumm, M., Piosczyk, B., Kern, S., Flamm, J., Rzesnicki, T., 2009, Novel numerical method for the analysis and synthesis of the fields in highly oversized waveguide mode converters, *IEEE Transactions on Microwave Theory and Techniques*, **57**, 1661-1668.
- [263] Jin, J., Flamm, J., Kern S., Rzesnicki, T., Thumm, M., 2010, Design of phase correcting mirror system for coaxial-cavity ITER gyrotron, *Proc. 11th IEEE Int. Vacuum Electronics Conference (IVEC 2010)*, Monterey, USA, pp. 29-30.
Jin, J., Rzesnicki, T., Kern, S., Thumm, M., 2011, High-efficiency quasi-optical mode converter for the coaxial cavity gyrotron. *Fusion Science and Technology*, **59**, 742-748.
- [264] Flamm, J.H., Jin, J., Thumm, M.K., 2011, Wave propagation in advanced gyrotron output couplers, *J. Infrared Milli Terahz Waves*, **32**, 887-896.
- [265] Zaginaylov, G.I., Shcherbinin, V.I., Schuenemann, K., Thumm, M.K., 2006, Influence of background plasma on electromagnetic properties of "cold" gyrotron cavity. *IEEE Trans. on Plasma Science*, **PS-34**, 512-517.
- [266] Pendergast, K.D., Danly, B.G., Menninger, W.L., Temkin, R.J., 1992, A long-pulse CARM oscillator experiment. *Int. J. Electronics*, **72**, 983-1004.

- [267] Galuzo, S.Yu., Kanavets, V.I., Slepikov, A.I., Pletyushkin, V.A., 1982, Relativistic cyclotron accelerator exploiting the anomalous Doppler effect. *Sov. Phys. Tech. Phys.*, **27**, 1030-1032.
- [268] Didenko, A.N., Borisov, A.R., Fomenko, G.P., Shlapakovskii, A.S., Shtein, Yu.G., 1983, Cyclotron maser using the anomalous Doppler effect. *Sov. Phys. Tech. Lett.*, **9**, 572-573.
- [269] Ogura, K., Amin, M.R., Minami, K., Zheng, X.D., Suzuki, Y., Kim, W.S., Watanabe, T., Carmel, Y., Granatstein, V.L., 1996, Experimental demonstration of a high-power slow-wave electron cyclotron maser based on a combined resonance of Cherenkov and anomalous Doppler interactions. *Phys. Rev. Lett. E*, **53**, 2726-2729.
- [270] Guo, H., Chen, L., Keren, H., Hirshfield, J.L., Park, S.Y., Chu, K.R., 1982, Measurements of gain for slow cyclotron waves on an annular electron beam. *Phys. Rev. Lett.*, **49**, 730-733.
- [271] Granatstein, V.L., Read, M.E., Barnett, L.R., 1982, Measured performance of gyrotron oscillators and amplifiers, in *Infrared and Millimeter Waves*, **Vol. 5**, ed. K.J. Button, Academic Press, New York, 267-304.
- [272] Chu, K.R., Lin, A.T., 1988, Gain and bandwidth of the gyro-TWT and CARM amplifiers. *IEEE Trans. on Plasma Science*, **Vol. 16**, 90-103.
- [273] Chu, K.R., Chen, H.-Y., Hung, C.-L., Chang, T.-H., Barnett, L.R., Chen, S.-H., Yang, T.-T., Dialetis, D.J., 1999, Theory and experiment of ultrahigh-gain gyrotron traveling wave amplifier. *IEEE Trans. on Plasma Science*, **PS-27**, 391-404.
- [274] Chu, K.R., 2002, Overview of research on the gyrotron traveling-wave amplifier. *IEEE Trans. on Plasma Science*, **PS-30**, 903-908.
- [275] Denisov, G.G., Bratman, V.L., Phelps, A.D.R., Samsonov, S.V., 1998, Gyro-TWT with a helical operating waveguide: new possibilities to enhance efficiency and frequency bandwidth. *IEEE Trans. on Plasma Science*, **PS-26**, 508-518.
- [276] Bratman, V.L., Cross, A.W., Denisov, G.G., Phelps, A.D.R., Samsonov, S.V., 2005, Microwave devices with helically corrugated waveguides. In: *Quasi-Optical Control of Intense Microwave Transmission*, eds. J.L. Hirshfield and M.I. Petelin, Springer, 105-114.
- [277] Guo, H., Chen, S.H., Granatstein, V.L., Rodgers, J., Nusinovich, G., Levush, B., Walter, M., Chen, W.J., 1997, A high performance, frequency doubling, inverted gyrotwystron. *Conf. Digest 22nd Int. Conf. on Infrared and Millimeter Waves*, Wintergreen, Virginia, USA, 285-286.
- [278] Bratman, V.L., Kalynov, Yu.K., Manuilov, V.N., Samsonov, S.V., 2005, Submillimeter-wave large-orbit gyrotron. *Radiophysics and Quantum Electronics*, **48**, 731-736.
- [279] Ganguly, A.K., Ahn, S., Park, S.Y., 1988, Three dimensional nonlinear theory of the gyropeniotron amplifier. *Int. J. Electronics*, **65**, 597-618.
- [280] Nezhevenko, O.A., 1994, Gyrocons and magnicons: Microwave generators with circular deflection of the electron beam. *IEEE Trans. on Plasma Science*, **PS-5**, 756-772.
- [281] Karliner, M.M., Kozyrev, E.V., Makarov, I.G., Nezhevenko, O.A., Ostreiko, G.N., Persov, B.Z., Serdobintsev, G.V., 1998, The magnicon – an advanced version of the gyrocon. *Nucl. Instr. and Meth. in Phys. Res.*, **A269**, 459-473.
- [282] Hirshfield, J.L., LaPointe, M.A., Yoder, R.B., Ganguly, A.K., Wang, Ch., Hafizi, B., 1996, High-power microwave production by gyroharmonic conversion and co-generation. *Proc. 3rd Int. Workshop on Strong Microwaves in Plasmas*, Nizhny Novgorod, 1997, **Vol.2**, 730-744.
- [283] Hirshfield, J.L., LaPointe, M.A., Wang, C., Ganguly, A.K., 1999, 20 GHz high-power gyroharmonic co-generation. *Proc. 4th Int. Workshop on Strong Microwaves in Plasmas*, Nizhny Novgorod, ed. A.G. Litvak, Inst. of Applied Physics, Russian Academy of Sciences, Nizhny Novgorod, 2000, **Vol. 2**, 728-739.

- [284] Wang, M., Ganguly, A.K., Hirshfield, J.L., 2002, Observation of stimulated emission at high gyroharmonics: basis for a synchrotron resonance maser. *Phys. Rev. Lett.*, **87**, 153801-1/4.
- [285] Phillips, R.M., 1960, The ubitron, a high-power traveling-wave tube based on a periodic beam interaction in unloaded waveguide. *IRE Trans. Electron. Dev.*, **ED-7**, 231-241 and, 1988, History of the ubitron. *Nucl. Instr. Meth.*, **A272**, 1-9, and, 1998, private communication.
- [286] Drori, R., Jerby, E., 1997, Free-electron-laser-type interaction at 1 meter wavelength range. *Nucl. Instr. Meth.*, **A393**, 284.
- [287] Verhoeven, A.G.A., Bongers, W.A., Best, R.W.B., van Ingen, A.M., Manintveld, P., Urbanus, W.H., van der Wiel, M.J., Bratman, V.L., Denisov, G.G., Shmelyov, M.Yu., Nickel, H.-U., Thumm, M., Müller, G., Kasperek, W., Pretterebner, J., Wagner, D., Caplan, M., 1992, The 1 MW, 200 GHz FOM-Fusion-FEM. *Conf. Digest 17th Int. Conf. on Infrared and Millimeter Waves, Pasadena (Los Angeles), Proc.*, SPIE **1929**, 126-127.
- [288] Urbanus, W.H., Best, R.W.B., Bongers, W.A., van Ingen, A.M., Manintveld, P., Sterk, A.B., Verhoeven, A.G.A., van der Wiel, M.J., Caplan, M., Bratman, V.L., Denisov, G.G., Varfolomeev, A.A., Khlebnikov, A.S., 1993, Design of the 1 MW, 200 GHz, FOM fusion FEM. *Nucl. Instr. Meth.*, **A 331**, 235-240.
- [289] Verhoeven, A.G.A., Bongers, W.A., van der Geer, C.A.J., Manintveld, P., Schüller, F.C., Urbanus, W.H., Valentini, M., van der Wiel, M.J., 1995, A broad-tuneable free electron maser for ECW applications. *Proc. 9th Joint Workshop on Electron Cyclotron Emission and Electron Cyclotron Heating, Borrego Springs, California*, 309-320.
- [290] Verhoeven, A.G.A., Bongers, W.A., Bratman, V.L., Caplan, M., Denisov, G.G., van Dijk, G., van der Geer, C.A.J., Manintveld, P., Poelmann, A.J., Pluygers, J., Shmelyov, M.Yu., Smeets, P.H.M., Sterk, A.B., Urbanus, W.H., 1998, First high power experiments with the Dutch free electron maser. *Physics of Plasmas*, **5**, 2029-2036.
- [291] Verhoeven, A.G.A., Bongers, W.A., Bratman, V.L., Caplan, M., Denisov, G.G., van der Geer, C.A.J., Manintveld, P., Poelman, A.J., Pluygers, J., Shmelyov, M.Yu., Smeets, P.H.M., Sterk, A.B., Urbanus, W.H., 1998, First microwave generation in the FOM free electron maser. *Plasma Phys. and Contr. Fusion*, **40, Suppl. 8A**, 139-156.
- [292] Verhoeven, A.G.A., Bongers, W.A., Bratman, V.L., Caplan, M., Denisov, G.G., van der Geer, C.A.J., Manintveld, P., Poelman, A.J., Plomb, J., Savilov, A.V., Smeets, P.H.M., Urbanus, W.H., 1998, First generation of mm-waves in the dutch free-electron maser. *Conf. Digest 23rd Int. Conf. on Infrared and Millimeter Waves, Colchester, UK*, 21-23.
- [293] Urbanus, W.H., Bongers, W.A., van der Geer, C.A.J., Manintveld, P., Plomb, J., Pluygers, J., Poelmann, A.J., Smeets, P.H.M., Verhoeven, A.G.A., Bratman, V.L., Denisov, G.G., Savilov, V., Shmelyov, M.Yu., Caplan, M., Varfolomeev, A.A., Tolmachev, S.V., Ivanchenkov, S.N., 1999, High-power electrostatic free-electron maser as a future source for fusion plasma heating: Experiments in the short-pulse regime. *Phys. Rev. E*, **59**, 6058-6063.
- [294] Verhoeven, A.G.A., Bogers, W.A., Bratman, V.L., Caplan, M., Denisov, G.G., van der Geer, C.A.J., Manintveld, P., Poelmann, A.J., Plomp, J., Savilov, A.V., Smeets, P.H.M., Sterck, A.B., Urbanus W.H., 1999, First mm-wave generation in the FOM free electron maser. *IEEE Trans. on Plasma Science*, **PS-27**, 1084-1091.
- [295] Urbanus, W.H., Bratman, V.L., Bongers, W.A., Caplan, M., Denisov, G.G., van der Geer, C.A.J., Manintveld, P., Militsyn, B., Oomens, A.A.M., Poelman, A.J., Plomp, J., Pluygers, J., Savilov, A.V., Smeets, P.H.M., Sterk, A.B., Verhoeven, A.G.A., 2001, A high power, tunable free electron maser for fusion. *Fusion Engineering and Design*, **53**, 423-430.

- [296] Militsyn, B.L., Bongers, W.A., Bratman, V.L., Caplan, M., Denisov, G.G., van der Geer, C.A.J., Manintveld, P., Oomens, A.A.M., Plomp, J., Pluygers, J., Poelman, A.J., Riet, M., Savilov, A.V., Smeets, P.H.M., Tito, C.J., Turk, G.H.B., Varfolomeev, A.A., Urbanus, W.H., 2002, First lasing of the Dutch fusion FEM in the long-pulse configuration. *Nucl. Instr. Meth.*, **A483**, 259-262.
- [297] Urbanus, W.H., Bongers, W.A., Bratman, V., van der Geer, C.A.J., Graswinckel, M.F., Manintveld, P., Militsyn, B.L., Savilov, A., and FEM Team, 2002, Long-pulse operation at constant output power and single-frequency mode of a high-power electrostatic free-electron maser with depressed collector. *Phys. Rev. Lett.*, **89**, 214801-1/-4.
- [298] Freund, H.P., Granatstein, V.L., 1995, Long wavelength free electron laser in 1994. *Nucl. Instr. Meth.*, **A358**, 551-554 and, 1996, *Nucl. Instr. Meth.*, **A375**, 665-668 and, 1997, *Nucl. Instr. Meth.*, **A393**, 9-12, and, 1998, *Nucl. Instr. Meth.*, **A407**, 30-33, and, 1999 *Nucl. Instr. Meth.*, **A429**, 33-36, and private communication.
- [299] Shaw, A., Al-Shammaá, A., Stuart, R.A., Balfour, C., Lucas, J., 1996, First results of a CW industrial FEM. *Nucl. Instr. Meth.*, **A357**, 245-247.
- [300] Dylla, H.F., 1999, An overview of the user program for the Jefferson Lab free electron laser. *Proc. SPIE*, **Vol. 3618**, 388-395.
- [301] Neil, G.R., Bohn, C.L., Benson, S.V., Biallas, G., Douglas, D., Dylla, H.F., Evans, R., Fugitt, J., Grippo, A., Gubeli, J., Hill, R., Jordan, K., Li, R., Meringa, L., Piot, P., Preble, J., Shinn, M., Siggins, T., Walker, R., Yunn, B., 2000, Sustained kilowatt lasing in a free-electron laser with same-cell energy recovery. *Phys. Rev. Lett.*, **84**, 662-665.
- [302] Benson, S.V., 2002, What have we learned from the kilowatt IR-FEL at Jefferson lab?, *Nucl. Instr. Meth.*, **A483**, 1-7.
- [303] Behre, C., Benson, S., Biallas, G., Boyce, J., Curtis, C., Douglas, D., Dylla, H.F., Dillon-Townes, L., Evans, R., Grippo, J., Hardy, D., Heckman, J., Hernandez-Garcia, C., Hiatt, T., Jordan, K., Meringa, L., Neil, G., Preble, J., Rutt, H., Shinn, M., Siggins, T., Toyokawa, H., Waldman, D.W., Walker, R., Wilson, N., Yunn, B., Zhang, S., 2004, First lasing of the IR upgrade FEL at Jefferson Lab. *Nuclear Instruments & Methods in Physics Research*, **528**, No. 1-2, 19-22.
- [304] Neil, G.R., 2005, The JLab IR upgrade FEL facility. *Conf. Digest 30th Int. Conf. on Infrared and Millimeter Waves and 13th Int. Conf. on Terahertz Electronics*, Williamsburg, VA, USA, 573-574.
- [305] Boyce, J.R., 2005, The Jefferson Lab high power light source. *Proc. 7th Workshop on High Energy Density and High Power RF*, AIP Conference Proceedings **807**, 2006, 348-355.
- [306] Thomas, A.W., Williams, G.P., 2007, The free electron laser at Jefferson Lab: the technology and the science. *Proceedings of the IEEE*, **95**, 1679-1682.
- [307] Kulipanov, G.N., Gavrilov, N.G., Knyazev, B.A., Kolobanov, E.I., Kotenkov, V.V., Kubanov, V.V., Matveenko, A.N., Medvedev, L.E., Miginsky, S.V., Mironenko, L.A., Ovchar, V.K., Popik, V.M., Salikova, T.V., Scheglov, M.A., Serebnyakov, S.S., Shevchenko, O.A., Skriniski, A.N., Tcheskidov, V.G., Vinokurov, N.A., Demyanenko, M.A., Esaev, D.G., Naumova, E.V., Prinz, V.Y., Fedin, V.P., Gonchar, A.M., Peltek, S.E., Petrov, A.K., Merzhievsky, L.A., Cherkassky, V.S., 2008, Research highlights from the Novosibirsk 400 W average power THz FEL, *Int. J. of Terahertz Science and Technology*, **1**, 51-125.
- [308] Akberdin, R.R., Chesnokov, E.N., Dem'yanenko, M.A., Esaev, D.G., Goryachevskaya, T.N., Klimov, A.E., Knyazev, B.A., Kolobanov, E.I., Kozlov, A.S., Kubarev, V.V., Kulipanov, G.N., Kuznetsov, S.A., Matveenko, A.N., Medvedev, L.E., Naumova, E.V., Okotrub, A.V., Ovchar, V.K., Palagin, K.S., Paschin, N.S., Peltek, S.G., Petrov, A.K., Prinz, V.Ya., Popik, V.M., Salikova, T.V., Serebnyakov, S.S., Skriniski, A.N., Shevchenko, O.A., Scheglov, M.A., Vinokurov, N.A., Vlasenko, M.G., Yakovlev, V.V., Zaigraeva, N.S., 2009, High power THz applications on the NovoFEL, *Proc. 34th Int. Conf. on Infrared, Millimeter and Terahertz Waves*, Busan, Korea, T3C01.0521.

- [309] Kubarev, V.V., Kulipanov, G.N., Shevchenko, O.A., Vinokurov, N.A., 2010, Third harmonic lasing on Terahertz NovoFEL, Proc. 35th Int. Conf. on Infrared, Millimeter and Terahertz Waves, Rome, Italy, Mo-F2.1.
- [310] Vinokurov, N., 2011, Free electron lasers as a High-power Terahertz Sources, J. Infrared Milli Terahz Waves, **32**, 1123-1143.
- [311] Kaminsky, A.K., Perel'shtein, E.A., Sedykh, S.N., Ginzburg, N.S., Kuzikov, S.V., Peskov, N.Yu., Sergeev, A.S., 2010, Demonstrating high-power 30-GHz free-electron maser operation on a resonant load. Technical Physics Letters, **36**, 211-215.
- [312] Jödicke, B., Mathews, H.-G., Agosti, G., Alberti, S., Bondeson, A., Hogge, J.P., Isaak, B., Muggli, P., Perrenoud, A., Tran, T.M., Tran, M.Q., 1989, Entwicklung von Hochleistungs-Gyrotrons in der Schweiz. ITG-Fachbericht **108**, VDE-Verlag GmbH, Berlin, 191-195.
- [313] Einat, M., Pilosof, M., Ben-Moshe, R., Hirshbein, H., Borodin, D., 2012, 95 GHz gyrotron with ferroelectric cathode. Physical Review Letters, **109**, 185101 (5 pp).
- [314] Lawrence Ives, R., Jory, H., Neilson, J., Chodorow, M., Feinstein, J., LaRue, A.D., Zitelli, L., Martorana, R., 1993, Development and test of a 500 kW, 8-GHz gyrotron. IEEE Trans. on Electron Devices, **ED-40**, 1316-1321.
- [315] Felch, K., Chu, T.S., Feinstein, J., Huey, H., Jory, H., Nielson, J., Schumacher, R., 1992, Long-pulse operation of a gyrotron with beam/rf separation. Conf. Digest 17th Int. Conf. on Infrared and Millimeter Waves, Pasadena, Proc., SPIE **1929**, 184-195.
- [316] Chu, T.S., Blank, M., Borchard, P., Cahalan, P., Cauffman, S., Felch, K., Jory, H., Saraph, G., Wagner, D., 2000, Recent progress in producing megawatt gyrotrons for ECH applications. Conf. Digest 25th Int. Conf. on Infrared and Millimeter Waves, Beijing, P.R. China, 13-14.
- [317] Felch, K., Blank, M., Borchard, P., Cahalan, P., Cauffman, S., Chu, T.S., Jory, H., 2002, Progress update on CPI 500 kW and 1 MW, multi-second-pulsed gyrotrons. Proc. 3rd IEEE Int. Vacuum Electronics Conf. (IVEC 2002), Monterey, USA, 332-333.
- [318] Chu, T.S., Blank, M., Borchard, P., Cahalan, P., Cauffman, S., Felch, K., Jory, H., 2002, Operation of a 500 kW, 84 GHz, long pulse gyrotron with collector potential depression. Proc. 27th Int. Conf. on Infrared and Millimeter Waves, San Diego, USA, 5-6.
- [319] Blank, M., Borchard, P., Cahalan, P., Cauffman, S., Chu, T.S., Felch, K., Jory, H., 2002, Development and demonstration of gyrotron oscillators and amplifiers at CPI. Proc. 5th Int. Workshop on Strong Microwaves in Plasmas, Nizhny Novgorod, ed. A.G. Litvak, Inst. of Applied Physics, Russian Academy of Sciences, Nizhny Novgorod, 2003, **Vol. 1**, 7-15.
- [320] Bae, Y.S., Lee, H.K., Jeong, J.H., Namkung, W., Cho, M.H., Chu, S., 2003, Operation of high power 84-GHz gyrotron for KSTAR ECH system. 4th IEEE Int. Vacuum Electronics Conf. (IVEC 2003), Seoul, Korea, 38-39.
- [321] Bae, Y.S., Na, Y.S., Oh, Y.K., Kwon, M., Bak, J.S., Lee, G.S., Jeong, J.H., Park, S.I., Cho, M.H., Namkung, W., Ellis, R.A., Park, H., Sakamoto, K., Takahashi, K., Yamamoto, T., 2007, Status of KSTAR electron cyclotron heating system, Fusion Science and Technology, **52**, 321-333.
- [322] Felch, K., Blank, M., Borchard, P., Cahalan, P., Cauffman, S., Chu, T.S., Jory, H., 2004, Demonstration of a 95 GHz, 100 kW, CW gyrotron oscillator. 5th IEEE Int. Vacuum Electronics Conf. (IVEC 2004), Monterey, CA, USA, 63-64.
- [323] Cauffman, S., Blank, M., Cahalan, P., Felch, K., McGhee, R.W., Coffey, M., 2006, Operation of a 95 GHz 100 kW gyrotron in a high-T_c (BSCCO) magnet. Proc. Int. Vacuum Electronics Conference and Int. Vacuum Electron Sources (IVEC/IVESC 2006), Monterey, California, USA, 537-538.
- [324] Cauffman, S., Blank, M., Felch, K., Borchard, P., Cahalan, P., Jory, H., 2007, Initial testing of a 95 GHz, 2.5 MW gyrotron. Conf. Digest 32nd Int. Conf. on Infrared and Millimeter Waves and 15th Int. Conf. on Terahertz Electronics, Cardiff, UK, 94-95.

- [325] Blank, M., Borchard, P., Cahalan, P., Cauffman, S., Felch, K., Jory, H., 2008, Development and demonstration of a multi-megawatt 95 GHz gyrotron oscillator, Proc. 9th IEEE Int. Vacuum Electronics Conference (IVEC 2008), Monterey, CA, USA, 32-33.
- [326] Felch, K., Blank, M., Borchard, P., Cahalan, P., Cauffman, S., Jory, H., 2008, Recent test results on a 95 GHz, 2 MW gyrotron, Proc. 33rd Int. Conf. on Infrared, Millimeter and Terahertz Waves, Pasadena, CA, USA, T2A2.1608.
- [327] Blank, M., Borchard, P., Cahalan, P., Cauffman, S., Felch, K., 2010, Development and demonstration of a multi-megawatt 95 GHz gyrotron, Proc. 11th IEEE Int. Vacuum Electronics Conference (IVEC 2010), Monterey, USA, pp. 189-190.
- [328] Blank, M., Borchard, P., Cahalan, P., Cauffman, S., Felch, K., 2011, Megawatt class gyrotron development at CPI. Proc. 8th Int. Workshop on Strong Microwaves and Terahertz Waves: Sources and Applications, Nizhny Novgorod – St. Petersburg, Russia, July 9-16, 2011, p. 8.
- [329] Blank, M., Borchard, P., Cahalan, P., Cauffman, S., Felch, K., 2011, Demonstration of a multi-megawatt 95 GHz gyrotron, Proc. 36th Int. Conf. on Infrared, Millimeter and Terahertz Waves (IRMMW-THz 2011), Houston, TX, USA, Th4A.5.
- [330] Felch, K., Blank, M., Borchard, P., Cahalan, P., Cauffman, S., 2012, Recent high-power gyrotron activities at 95, 110 and 170 GHz, Proc. 13th IEEE Int. Vacuum Electronics Conference and 9th IEEE Int. Vacuum Electron Sources Conference (IVEC-IVESC 2012), Monterey, CA, USA, pp. 109-110.
- [331] Cauffman, S., Blank, M., Borchard, P., Felch, K., 2012, Recent development and testing of megawatt-class gyrotrons, 38th Int. Conf. on Infrared, Millimeter and Terahertz Waves (IRMMW-THz 2012), Wollongong, Australia, Sept 23-28, 2012, Tue-A-3-3.
- [332] Shimozuma, T., Sato, M., Takita, Y., Kubo, S., Idei, H., Ohkubo, K., Kuroda, T. Tubokawa, Y., Huey, H., Jory, H., 1994, Development of a high power 84 GHz gyrotron. Conf. Digest 19th Int. Conf. on Infrared and Millimeter Waves, Sendai, JSAP Catalog No.: **AP 941228**, 65-66.
- [333] Sato, M., Shimozuma, T. Takita, Y., Kubo, S., Idei, H., Ohkubo, K., Kudora, T., Watari, T., Loring, Jr., M., Chu, S., Felch, K., Huey, H., 1995, Development of a high power 84 GHz gyrotron. Conf. Digest 20th Int. Conf. on Infrared and Millimeter Waves, Lake Buena Vista (Orlando), Florida, 195-196.
- [334] Shimozuma, T., Sato, M., Takita, Y., Ito, S., Kubo, S., Idei, H., Ohkubo, K., Watari, T., Chu, T.S., Felch, K., Cahalan, P., Loring, Jr., C.M., 1997, The first experiments on an 84 GHz gyrotron with a single-stage depressed collector. Conf. Digest 22nd Int. Conf. on Infrared and Millimeter Waves, Wintergreen, Virginia, USA, 194-195, and private communication.
- [335] Shimozuma, T., Sato, M., Kubo, S., Idei, H., Yoshimura, Y., Takita, Y., Ito, S., Kobayashi, S., Mizuno, Y., Ohkubo, K., and LHD Experimental Group G1, G2, 1999, ECRH system and initial experiments in Large Helical Device. Conf. Digest 24th Int. Conf. on Infrared and Millimeter Waves, Monterey, California, USA, TU-D6.
- [336] Bogdanov, S.D., Gyrotron Team, Solujanava, E.A., 1994, Industrial gyrotrons from GYCOM. Conf. Digest 19th Int. Conf. on Infrared and Millimeter Waves, Sendai, JSAP Catalog No.: **AP 941228**, 351-352.
- [337] Zapevalov, V.E., Belousov, V.I., Bogdashov, A.A., Bykov, Yu.V., Chirkov, A.V., Denisov, G.G., Glyavin, M.Yu., Kuftin, A.N., Litvak, A.G., Lygin, V.K., Malygin, V.I., Malygin, O.V., Moiseev, M.A., Agapova, M.V., Gnedenkov, A.Ph., Iljin, V.N., Khmara, D.V., Kostyna, A.N., Kurbatov, V.I., Myasnikov, V.E., Nichiporenko, V.O., Popov, L.G., Usachev, S.V., Malygin, S.A., Solujanova, E.A., Tai, E.M., Roschin, Yu.V., Iljin, V.I., 2004, Evolution of Russian gyrotrons for fusion and technological application. Proc. 10th Int. Conf. Displays and Vacuum Electronics, Garmisch-Partenkirchen, ITG-Fachbericht **183**, 41-44.

- [338] Goldenberg, A.L., Litvak, A.G., 1995, Recent progress of high-power millimeter wavelength gyrodevices. *Phys. Plasmas*, **2**, 2562-2572 and private communications.
- [339] Kurbatov, V.I., Malygin, S.A., Orlov, V.B., Solujanova, E.A., Tai, E.M., 1999, 70-140 GHz 1 MW gyrotrons on their way to CW operation. Proc. 4th Int. Workshop on Strong Microwaves in Plasmas, Nizhny Novgorod, ed. A.G. Litvak, Inst. of Applied Physics, Russian Academy of Sciences, Nizhny Novgorod, 2000, **Vol. 2**, 641-650.
- [340] Belousov, V.I., Bogdashov, A.A., Denisov, G.G., Kurbatov, V.I., Malygin, V.I., Malygin, S.A., Orlov, V.B., Popov, L.G., Solujanova, E.A., Tai, E.M., Usachov, S.V., 2004, Test results of the 84 GHz / 200 kW / CW gyrotron. 13th Joint Workshop on Electron Cyclotron Emission and Electron Cyclotron Resonance Heating, Nizhny Novgorod, Russia, May 17-20, 2004.
- [341] Litvak, A.G., Agapova, M.V., Denisov, G.G., Kurbatov, V.I., Tai, E.M., Malygin, S.A., Myasnikov, V.E., Ilyin, V.I., Usachev, S., Zapevalov, V.E., 2002, New results in development of MW output power gyrotrons for fusion systems, Proc. 27th Int. Conf. on Infrared and Millimeter Waves, San Diego, USA, 295-296, and private communications, 2002.
- [342] Zapevalov, V.E., Kalynov, Khizhnjak, V.I., Yu.K., Lygin, V.K., Malygin, O.V., Malygin, S.A., Moiseev, M.A., Manuilov, V.N., Solujanova, E.A., Tai, E.M., 2004, Low frequency gyrotrons for fusion. Proc. 13th Joint Workshop on Electron Cyclotron Emission and Electron Cyclotron Resonance Heating, Nizhny Novgorod, Russia, 2005, 403-408.
- [343] Belousov, V.I., Bogdashov, A.A., Denisov, G.G., Kurbatov, V.I., Malygin, V.I., Malygin, S.A., Orlov, V.B., Popov, L.G., Solujanova, E.A., Tai, E.M., Usachev, S.V., 2004, Test results of the 84 GHz/200 kW/CW gyrotron. Proc. 13th Joint Workshop on Electron Cyclotron Emission and Electron Cyclotron Heating (EC13), ed. A. Litvak, Inst. of Applied Physics, Russian Academy of Sciences, Nizhny Novgorod, 2005, 388-392.
- [344] Denisov, G.G., Belousov, V.I., Chirkov, A.V., Litvak, A.G., Malygin, V.I., Shmelyov, M.Yu., Kurbatov, V.I., Kazanskiy, I.V., Solujanova, E.A., Tai, E.M., 2005, 200 kW/CW gyrotrons and transmission line components for fusion systems. Proc. 6th IEEE Int. Vacuum Electronics Conf. (IVEC 2005), Noordwijk, The Netherlands, 119-120.
- [345] Denisov, G.G., Litvak, A.G., Myasnikov, V.E., Tai, E.M., 2005, Recent results in Gycom/IAP development of high-power gyrotrons for fusion installations. Proc. 6th IEEE Int. Vacuum Electronics Conf. (IVEC 2005), Noordwijk, The Netherlands, 497-500.
- [346] Kurbatov, V.I., Malygin, S.A., Orlov, V.B., Solujanova, E.A., Tai, E.M., Bogdashov, A.A., Chirkov, A.V., Denisov, G.G., Malygin, V.I., Pavelev, A.B., 2005, CW gyrotrons and attendant components at 200 kW microwave power level. Proc. 6th Int. Workshop on Strong Microwaves in Plasmas, Nizhny Novgorod, ed. A.G. Litvak, Inst. of Applied Physics, Russian Academy of Sciences, Nizhny Novgorod, 2006, **Vol. 1**, 113-118.
- [347] Zapevalov, V.E., Manuilov, V.N., Malygin, O.V., Tsimring, Sh.E., 1994, High-power twin-beam gyrotrons operating at the second gyrofrequency harmonic. *Radiophys. and Quantum Electronics*, **37**, 237-240.
- [348] Chen, Z.-G., 1992, Luo, L., 2000, private communications, Institute of Electronics, Chinese Academy of Sciences (IEAS), Beijing, P.R. China and Guo, H., Wu, D.S., Liu, G., Miao, Y.H., Qian, S.Z., Qin, W.Z., 1990, Special complex open-cavity and low-magnetic field high power gyrotron. *IEEE Trans. on Plasma Science*, **PS-18**, 326-333.
- [349] Yao, X., Jiang, D., Feng, C., Yang, X., Zhang, H., Qi, X., Jiang, D., Li, Z., Wang, L., Zheng, S., 2000, Electron cyclotron wave current startup for ohmic discharges on the CT-6B tokamak. *IEEE Trans. on Plasma Science*, **PS-28**, 323-330.
- [350] Xu, S.-X., Wang, B., Geng, Z.-H., Wang, H., Gu, W., Su, Y.-N., Liu, P.-K., 2011, Study of a quasi-optical mode converter for W-band gyrotron oscillator, *IEEE Trans. on Plasma Science*, **39**, 3345-3350.

- [351] Barroso, J.J., Castro, P.J., Pimenta, A.A., Spassov, V.A., Corrêa, R.A., Idehara, T., Ogawa, I., 1997, Operation of a 32 GHz gyrotron. *Int. J. Infrared and Millimeter Waves*, **18**, 2147-2160.
- [352] Maekawa, T., Teremuchi, Y., Yoshimura, S., Matsunaga, K., 1996, ECH system using an 88 GHz gyrotron for the WT-3 tokamak. *Proc. 11th Topical Conference on RF in Plasmas, Palm Springs, AIP Conf. Proc.*, **355**, 437-440.
- [353] Idehara, T., 1995, private communication, Fukui University Japan.
- [354] Carmel, Y., Chu, K.R., Dialetis, D., Fliflet, A., Read, M.E., Kim, K.J., Arfin, B., Granatstein, V.L., 1982, Mode competition, suppression, and efficiency enhancement in overmoded gyrotron oscillators. *Int. J. on Infrared and Millimeter Waves*, **3**, 645-665.
- [355] Carmel, Y., Chu, K.R., Read, M., Ganguly, A.K., Dialetis, D., Seeley, R., Levine, J.S., Granatstein, V.L., 1983, Realization of a stable and highly efficient gyrotron for controlled fusion research. *Physical Review Letters*, **50**, 112-116.
- [356] Rhinewine, M., Read, M.E., 1986, A TE_{1,3} gyrotron at 85 GHz. *Int. J. Electronics*, **61**, 729-733.
- [357] Behm, K., Jensen, E., 1986, 70 GHz gyrotron development at Valvo. *Conf. Digest 11th Int. Conf. on Infrared and Millimeter Waves, Pisa*, 218-220.
- [358] Kas'yanenko, D.V., Louksha, O.I., Piosczyk, B., Sominski, G.G., Thumm, M., 2002, Low-frequency parasitic oscillations in the 74.2 GHz moderate-power pulse gyrotron. *Proc. 5th Int. Workshop on Strong Microwaves in Plasmas, Nizhny Novgorod*, ed. A.G. Litvak, Inst. of Applied Physics, Russian Academy of Sciences, Nizhny Novgorod, 2003, **Vol. 1**, 162-167.
- [359] Kas'yanenko, D.V., Louksha, O.I., Sominski, G.G., Piosczyk, B., Thumm, M., 2004, Experimental investigation of electron energy spectra in the collector region of moderate-power millimeter-wave gyrotron. *Proc. 10th Int. Conf. Displays and Vacuum Electronics, Garmisch-Partenkirchen, ITG-Fachbericht* **183**, 81-86.
- [360] Kas'yanenko, D., Louksha, O., Piosczyk, B., Sominski, G., Thumm, M., 2004, Measurements of electron beam characteristics in the moderate-power 4-mm gyrotron. *Conf. Digest 29th Int. Conf. on Infrared and Millimeter Waves and 12th Int. Conf. on Terahertz Electronics, Karlsruhe, Germany*, 661-662.
- [361] Kas'yanenko, D.V., Louksha, O.I., Piosczyk, B., Sominsky, G.G., Thumm, M., 2004, Low-frequency parasitic space-charge oscillations in the helical electron beam of a gyrotron. *Radiophysics and Quantum Electronics*, **47**, Nos. 5-6, 414-420.
- [362] Louksha, O.I., Piosczyk, B., Louksa, O.I., Piosczyk, B., Sominski, G.G., Thumm, M., Samsonov, D.B., 2005, Effect of electron emission inhomogeneity on electron beam characteristics and output parameters of a 4-mm gyrotron. *Proc. 6th Int. Workshop on Strong Microwaves in Plasmas, Nizhny Novgorod*, ed. A.G. Litvak, Inst. of Applied Physics, Russian Academy of Sciences, Nizhny Novgorod, 2006, **Vol. 1**, 135-140.
- [363] Louksha, O., Piosczyk, B., Samsonov, D., Sominski, G., Thumm, M., 2006, Improvement of gyrotron beam quality by suppression of parasitic low-frequency oscillations. *Conf. Digest 31st Int. Conf. on Infrared and Millimeter Waves and 14th Int. Conf. on Terahertz Electronics, Shanghai, China*, 85.
- [364] Louksha, O.I., Piosczyk, B., Sominski, G.G., Thumm, M.K., Samsonov, D.B., 2006, On potentials of gyrotron efficiency enhancement: measurements and simulations on a 4-mm gyrotron. *IEEE Trans. on Plasma Science*, **PS-34**, 502-511.
- [365] Louksha, O.I., Piosczyk, B., Samsonov, D.B., Sominski, G.G., Thumm, M.K., 2007, Experimental study of gyrotron efficiency enhancement by improvement of electron beam quality. *Conf. Digest Joint 32nd Int. Conf. on Infrared and Millimetre Waves and 15th Int. Conf. on TeraHertz Electronics, Cardiff, UK*, 880-881.

- [366] Mourier, G., 1990, Current gyrotron development at Thomson Tubes Electroniques. Proc. Int. Workshop on Strong Microwaves in Plasmas, Suzdal, Inst. of Applied Physics, Nizhny Novgorod, 1991, 751-764 and, 1993, private communication.
- [367] Kariya, T., Mitsunaka, Y., Imai, T., Saito, T., Tatematsu, Y., Sakamoto, K., Minami, R., Watanabe, O., Numakura, T., Endo, Y., 2007, Optimization of 28 GHz gyrotron output performance for ECRH experiment of the GAMMA 10. Trans. of Fusion Science and Technology, **51**, 397-399.
- [368] Ota, M., Kariya, T., Imai, T., Sakamoto, K., Minami, R., Endo, Y., Aoki, H., Iizumi, H., Kondou, H., 2011, Development of 28 GHz – 1 MW gyrotron for GAMMA10 ECRH. Trans. of Fusion Science and Technology, **59**, 238-240.
- [369] Kariya, T., Minami, R., Imai, T., Sakamoto, K., Kubo, S., Shimosuma, T., Takahashi, H., Ito, S., Mutoh, T., Mitsunaka, Y., Endo, Y., Shidara, H., Murofushi, N., Sakagoshi, Y., Yasutake, H., Okazaki, Y., 2009, Development of 28 GHz and 77 GHz 1 MW gyrotron for ECRH of magnetically confined plasma, Trans. of Fusion Science and Technology, **55**, 91-94.
- [370] Kariya, T., Minami, R., Imai, T., Ota, M., Endo, Y., Kubo, S., Shimosuma, T., Takahashi, T., Yoshimura, Y., Ito, S., Mutoh, T., Sakamoto, K., Mitsunaka, Y., 2011, Development of 28 GHz and 77 GHz, mega-watt gyrotrons for fusion devices, J. Infrared Milli Terahz Waves, **32**, 295-310.
- [371] Kubo, S., Nishiura, M., Tanaka, K., Shimosuma, T., Tatematsu, Y., Notake, T., Saito, T., Yoshimura, Y., Igami, H., Takahashi, H., Tamura, N., 2010, Collective Thomson scattering study using gyrotron in LHD. Plasma and Fusion Research: Regular Articles, **5**, S1038 (5 pp).
- [372] Takahashi, H., Shimosuma, T., Ito, S., Kubo, S., Yoshimura, Y., Igami, H., Nishiura, M., Kobayashi, S., Mizuno, Y., Okada, K., Takita, Y., Yamada, I., Yokoyama, M., Ido, T., Shimizu, A., Ida, K., Matsuoka, S., Satake, S., Mutoh, T. and the LHD experiment group, 2011, Study of high T_e plasma characteristics of LHD using high power 77 GHz gyrotrons, Proc. 8th Int. Workshop Strong Microwaves and Terahertz Waves: Sources and Applications, Nizhny Novgorod – St. Petersburg, Russia, July 9-16, 2011, pp. 41-42.
- [373] Shimosuma, T., Takahashi, H., Ito, S., Kobayashi, S., Kubo, S., Yoshimura, Y., Igami, H., Nishiura, M., Ogasawara, S., Makino, R., Okada, K., Takita, Y., Ito, Y., Mutoh, T., Minami, R., Kariya, T., Imai, T., 2011, Optimization of high power and high efficiency operation of 77 GHz gyrotrons for ECRH in the large helical device, Proc. 36th Int. Conf. on Infrared, Millimeter and Terahertz Waves (IRMMW-THz 2011), Houston, TX, USA, W2A.1.
- [374] Kariya, T., Minami, R., Imai, T., Kubo, S., Shimosuma, T., Takahashi, H., Yoshimura, Y., Ito, S., Mutoh, T., Ota, M., Endo, Y., Sakamoto, K., 2011, Development of mega-watt gyrotrons for fusion research. Trans. of Fusion Science and Technology, **59**, 241-243.
- [375] Ogasawara, S., Kubo, S., Nishiura, M., Tatematsu, Y., Saito, T., Tanaka, K., Shimosuma, T., Yoshimura, Y., Igami, H., Takahashi, H., Ito, S., Takita, Y., Kobayashi, S., Mizuno, Y., Okada, K., Minami, R., Kariya, T., Imai, T., 2012, Suppression of spurious mode oscillation in mega-watt 77-GHz gyrotron as a high quality probe beam source for the collective Thomson scattering in LHD. Review of Scientific Instruments, **83**, 10D731-1 (3 pages).
- [376] Li, H., Xie, Z., Wang, W., Luo, Y., Du, P., Den, X., Wang, H., Yu, S., Niu, X., Wang, L., Liu, S., 2002, 35 GHz third-harmonic gyrotron with a permanent magnet system. Proc. 27th Int. Conf. on Infrared and Millimeter Waves, San Diego, USA, 301-302.
- [377] Li, H., Xie, Z.-L., Wang, W., Luo, Y., Du, P., Den, X., Wang, H., Yu, S., Niu, X., Wang, L., Liu, S., 2003, A 35-GHz low-voltage third-harmonic gyrotron with a permanent magnet system. IEEE Trans. on Plasma Science, **PS-31**, 264-271.
- [378] Niu, X.-J., Wang, L., Li, H.-F., 2009, 94 GHz second-harmonic gyrotron with complex cavity, Proc. 10th IEEE Int. Vacuum Electronics Conference (IVEC 2009), Rome, Italy, pp. 469-470.

- [379] Niu, X.-J., Wang, L., Li, H.-F., 2009, Experimental investigation of 94 GHz second-harmonic gyrotrons, Proc. 10th IEEE Int. Vacuum Electronics Conference (IVEC 2009), Rome, Italy, pp. 485-486.
- [380] Niu, X.J., Li, W., Yu, S., Li, H.F., 2009, 94 GHz, 90 kW, CW, low-voltage gyrotron, Proc. 34th Int. Conf. on Infrared, Millimeter and Terahertz Waves, Busan, Korea, M5E52.0392.
- [381] Liu, Y.-H., Niu, X., Liu, H., Yao, J., Zhou, J., Lei, C., Jiang, H., Yang, Y., Sun, Y., 2012, Design and experiment demonstration of a W-band second-harmonic gyrotron with complex cavity, Proc. 13th IEEE Int. Vacuum Electronics Conference and 9th IEEE Int. Vacuum Electron Sources Conference (IVEC-IVESC 2012), Monterey, CA, USA, pp. 337-338.
- [382] Niu, X.J., Gu, L., 2012, Experiment of 94 GHz, CW, low-voltage gyrotron, Proc. 13th IEEE Int. Vacuum Electronics Conference and 9th IEEE Int. Vacuum Electron Sources Conference (IVEC-IVESC 2012), Monterey, CA, USA, pp. 507-508.
- [383] Felch, K., Chu, T.S., DeHope, W., Huey, H., Jory, H., Nielson, J., Schumacher, R., 1994, Recent test results on a high-power gyrotron with an internal, quasi-optical converter. Conf. Digest 19th Int. Conf. on Infrared and Millimeter Waves, Sendai, JSAP Catalog No.: **AP 941228**, 333-334.
- [384] Neilson, J.M., Felch, K., Chu, T.S., Feinstein, J., Hess, C., Huey, H.E., Jory, H.R., Mizuhara, Y.M., Schumacher, R., 1995, Design and tests of a gyrotron with a radially-extracted electron beam. IEEE Trans. on Plasma Science, **PS-23**, 470-480.
- [385] Felch, K., Borchard, P., Chu, T.S., Jory, H., Loring, Jr., C.M., Neilson, J., Lorbeck, J.A., Blank, M., 1995, Long-pulse tests on a high-power gyrotron with an internal, quasi-optical converter. Conf. Digest 20th Int. Conf. on Infrared and Millimeter Waves, Lake Buena Vista (Orlando), Florida, 191-192.
- [386] Felch, K., Blank, M., Borchard, P., Chu, T.S., Feinstein, J., Jory, H.R., Lorbeck, J.A., Loring, C.M., Mizuhara, Y.M., Nielson, J.M., Schumacher, R., Temkin, R.J., 1996, Long-pulse and CW tests of a 110 GHz gyrotron with an internal, quasi-optical converter. IEEE Trans. on Plasma Science, **PS-24**, 558-569.
- [387] Felch, K., Borchard, P., Cahalan, P., Chu, T.S., Jory, H., Loring Jr., C.M., Moeller, C.P., 1996, Status of 1 MW CW gyrotron development at CPI. Proc. 21st Int. Conf. on Infrared and Millimeter Waves, Berlin, AM16.
- [388] Felch, R., Borchard, P., Cauffman, S., Callis, R.W., Cahalan, P., Chu, T.S., Denison, D., Jory, H., Mizuhara, M., Remsen, D., Saraph, G., Temkin, R.J., 1998, Status report on a 110 GHz, 1 MW, CW gyrotron with a CVD diamond window. Conf. Digest 23rd Int. Conf. on Infrared and Millimeter Waves, Colchester, UK, 376-368.
- [389] Chu, S., Blank, M., Borchard, P., Cauffman, S., Felch, K., Jory, H., 2004, Development of a 1.5 MW gyrotron at 110 GHz. 5th IEEE Int. Vacuum Electronics Conf. (IVEC 2004), Monterey, CA, USA, 30-31.
- [390] Chu, T.S., Blank, M., Cahalan, P., Cauffman, S., Felch, K., Jory, H., 2005, High power testing of a 110 GHz gyrotron with a single-stage depressed collector. Proc. 6th IEEE Int. Vacuum Electronics Conf. (IVEC 2005), Noordwijk, The Netherlands, 117-118.
- [391] Felch, K., Blank, M., Borchard, P., Cahalan, P., Cauffman, S., Jory, H., Gorelov, Y., Lohr, J., 2008, Operating experience on six 110 GHz, 1 MW gyrotrons for ECH applications. Nucl. Fusion, **48**, 054008 (4pp).
- [392] Chu, T.S., Blank, M., Borchard, P., Cahalan, P., Cauffman, S., Felch, K., Jory, H., 2003, Development of high power gyrotrons at 110 GHz and 140 GHz. 4th IEEE Int. Vacuum Electronics Conf. (IVEC 2003), Seoul, Korea, 32-33.
- [393] Blank, M., Borchard, P., Cahalan, P., Cauffman, S., Chu, T.S., Felch, K., Jory, H., 2004, Development of long-pulse, megawatt-class gyrotron oscillators at 110 and 140 GHz. Proc. 13th Joint Workshop on Electron Cyclotron Emission and Electron Cyclotron Heating (EC13), ed. A. Litvak, Inst. of Applied Physics, Russian Academy of Sciences, Nizhny Novgorod, 2005, 383-387.

- [394] Felch, K., Blank, M., Borchard, P., Cahalan, P., Cauffman, S., Chu, T.S., Jory, H., 2005, Recent advances in increasing output power and pulse duration in gyrotron oscillators. Conf. Digest 30th Int. Conf. on Infrared and Millimeter Waves and 13th Int. Conf. on Terahertz Electronics, Williamsburg, VA, USA, 237-238.
- [395] Jory, H., Blank, M., Borchard, P., Cahalan, P., Cauffman, S., Chu, T.S., Felch, K., 2005, CPI gyrotrons for fusion EC heating. Proc. 7th Workshop on High Energy Density and High Power RF, AIP Conference Proceedings **807**, 2006, 180-190.
- [396] Blank, M., Borchard, P., Cahalan, P., Cauffman, S., Chu, T.S., Felch, K., Jory, H., 2005, High-power gyrotron oscillator and broadband gyro-amplifier development at CPI. Proc. 6th Int. Workshop on Strong Microwaves in Plasmas, Nizhny Novgorod, ed. A.G. Litvak, Inst. of Applied Physics, Russian Academy of Sciences, Nizhny Novgorod, 2006, **Vol. 1**, 46-57.
- [397] Lohr, J., Cengher, M., Deboo, J., Gorelov, I.A., Moeller, C.P., Neilson, J., Young, D., Ponce, D., 2009, Performance of the six gyrotron system on the DIII-D tokamak, Proc. 34th Int. Conf. on Infrared, Millimeter and Terahertz Waves, Busan, Korea, R4D03.0203.
Lohr, J., Cengher, M., Doane, J.L., Ellis, R.A., Gorelov, Y.A., Kolemen, E., Moeller, C.P., Noraky, S., Penaflor, B.G., Ponce, D.M., Prater, R., Shapiro, M., Tax, D., 2012, Performance, diagnostics, controls and plans for the gyrotron system on the DIII-D tokamak. EPJ Web of conferences, **32**, 02009/1-6.
- [398] Felch, K., Blank, M., Borchard, P., Cahalan, P., Cauffman, S., 2012, Gyrotrons for magnetic fusion applications at 110 GHz and 170 GHz. EPJ Web of Conferences, **32**, 04007/1-5.
- [399] Borie, E., Dammertz, G., Gantenbein, G., Kuntze, M., Möbius, A., Nickel, H.-U., Piosczyk, B., Thumm, M., 1993, 0.5 MW/140 GHz TE_{10,4} Gyrotron with built-in highly efficient quasi-optical converter. Conf. Digest 18th Int. Conf. on Infrared and Millimeter Waves, Colchester (Essex, UK), Proc., SPIE **2104**, 519-520.
- [400] Geist, T., Thumm, M., Wiesbeck, W., 1991, Linewidth measurement on a 140 GHz gyrotron. Conf. Digest 16th Int. Conf. on Infrared and Millimeter Waves, Lausanne, Proc., SPIE **1576**, 272-273.
- [401] Thumm, M., Borie, E., Dammertz, G., Kuntze, M., Möbius, A., Nickel, H.-U., Piosczyk, B., Wien, A., 1993, Development of high-power 140 GHz gyrotrons for fusion plasma applications. Proc. 2nd Int. Workshop on Strong Microwaves in Plasma, Moscow - Nizhny Novgorod - Moscow, Inst. of Applied Physics, Nizhny Novgorod, 1994, **Vol. 2**, 670-689.
- [402] Gantenbein, G., Borie, E., Dammertz, G., Kuntze, M., Nickel, H.-U., Piosczyk, B., Thumm, M., 1994, Experimental results and numerical simulations of a high power 140 GHz gyrotron. IEEE Trans. Plasma Science, **PS-22**, 861-870.
Dumbrajs, O., Thumm, M., Pretterebner, J., Wagner, D., 1992, A cavity with reduced mode conversion for gyrotrons. Int. J. Infrared and Millimeter Waves, **13**, 825-840.
- [403] Thumm, M., Borie, E., Dammertz, G., Höchtl, O., Kuntze, M., Möbius, A., Nickel, H.-U., Piosczyk, B., Semmler, C., Wien, A., 1994, Development of advanced high-power 140 GHz gyrotrons at KfK. Conf. Digest 19th Int. Conf. on Infrared and Millimeter Waves, Sendai, JSAP Catalog No.: **AP 941228**, 57-58.
- [404] Thumm, M., Braz, O., Dammertz, G., Iatrou, C.T., Kuntze, M., Piosczyk, B., Soudeé, G., 1995, Operation of an advanced, step-tunable 1 MW gyrotron at frequencies between 118 GHz and 162 GHz. Conf. Digest 20th Int. Conf. on Infrared and Millimeter Waves, Lake Buena Vista (Orlando), Florida, 199-200.
- [405] Dammertz, G., Braz, O., Iatrou, C.T., Kuntze, M., Möbius, A., Piosczyk, B., Thumm, M., 1995, Highly efficient long-pulse operation of an advanced 140 GHz, 0.5 MW gyrotron oscillator. Conf. Digest 20th Int. Conf. on Infrared and Millimeter Waves, Lake Buena Vista (Orlando), Florida, 285-286.
- [406] Piosczyk, B., Iatrou, C.T., Dammertz, G., Thumm, M., 1995, Operation of gyrotrons with single-stage depressed collectors. Conf. Digest 20th Int. Conf. on Infrared and Millimeter Waves, Lake Buena Vista (Orlando), Florida, 491-492.

- [407] Dammertz, G., Braz, O., Kuntze, M., Piosczyk B., Thumm, M., 1997, Step-tunable 1 MW broadband gyrotron with Brewster window. Proc. 10th Joint Workshop on Electron Cyclotron Emission and Electron Cyclotron Resonance Heating, Ameland, The Netherlands, 483-488.
- [408] Dammertz, G., Braz, O., Chopra, A.K., Koppenburg, K., Kuntze, M., Piosczyk, B., Thumm, M., 1999, Recent results of the 1-MW, 140-GHz, TE_{22,6}-mode gyrotron. IEEE Trans. on Plasma Science, **PS-27**, 330-339.
- [409] Koppenburg, K., Arnold, A., Borie, E., Dammertz, G., Drumm, O., Kartikeyan, M.V., Piosczyk, B., Thumm, M., Yang, X., 2002, Design of a multifrequency high power gyrotron at FZK. Proc. 27th Int. Conf. on Infrared and Millimeter Waves, San Diego, USA, 153-154.
- [410] Thumm, M., Arnold, A., Borie, E., Dammertz, G., Drumm, O., Heidinger, R., Kartikeyan, M.V., Koppenburg, K., Meier, A., Piosczyk, B., Wagner, D., Yang, X., 2003, Development of frequency step tunable 1 MW gyrotrons in D-band. 4th IEEE Int. Vacuum Electronics Conf. (IVEC 2003), Seoul, Korea, 30-31.
Yang, X., Drumm, O., Arnold, A., Borie, E., Dammertz, G., Koppenburg, K., Wagner, D., Thumm, M., 2003, Design of a quasi-optical mode converter for a frequency step-tunable gyrotron. Int. J. of Infrared and Millimeter Waves, **24**, 1599-1608.
- [411] Koppenburg, K., Arnold, A., Borie, E., Dammertz, G., Drumm, O., Kartikeyan, M.V., Piosczyk, B., Thumm, M., Yang, X., 2003, Recent results of the multifrequency high power gyrotron development at FZK. Conf. Digest 28th Int. Conf. on Infrared and Millimeter Waves, Otsu, Japan, 125-126.
- [412] Koppenburg, K., Arnold, A., Borie, E., Dammertz, G., Drumm, O., Kartikeyan, M.V., Piosczyk, B., Thumm, M., Yang, X., 2004, Design of a step-tunable 105-140 GHz, 1 MW gyrotron at FZK. Proc. 10th Int. Conf. Displays and Vacuum Electronics, Garmisch-Partenkirchen, ITG-Fachbericht **183**, 55-59.
- [413] Prinz, O., Arnold, A., Gantenbein, G., Liu, Y., Thumm, M., Wagner, D., 2009, Highly efficient quasi-optical mode converter for a multifrequency high-power gyrotron, IEEE Transactions on Electron Devices, **56**, 828-834.
Prinz, O., Gantenbein, G., Thumm, M., 2007, Matching the output beam of a multi-frequency gyrotron to a Brewster window with small aperture, Proc. 8th IEEE International Vacuum Electronics Conference (IVEC 2007), Kitakyushu, Japan, 49-50.
Prinz, O., Arnold, A., Dammertz, G., Flamm, F., Gantenbein, G., Jin, J., Piosczyk, B., Rzesnicki, T., Thumm, M., 2007, Quasi-optical mode converter for a multi-frequency D-band gyrotron, Conf. Digest Joint 32nd Int. Conf. on Infrared and Millimetre Waves and 15th Int. Conf. on Terahertz Electronics, Cardiff, UK, 888-889.
Arnold, A., Prinz, O., Wagner, D., Thumm, M. 2007, Operation of a quasi-optical multi-mode generator for 105-150 GHz, Conf. Digest Joint 32nd Int. Conf. on Infrared and Millimetre Waves and 15th Int. Conf. on Terahertz Electronics, Cardiff, UK, 434-435.
Prinz, O., Gantenbein, G., Thumm, M., 2008, Advanced quasi-optical mode converter for a multi-frequency gyrotron, Proc. 9th IEEE Int. Vacuum Electronics Conference (IVEC 2008), Monterey, CA, USA, 64-65.
- [414] Agapova, M.V., Alikae, V.V., Axenova, L.A., Bogdashov, A.A., Borshchegovsky, A.S., Keyer, A.P., Denisov, G.G., Flyagin, V.A., Fix, A.Sh., Ilyin, V.I., Ilyin, V.N., Khmara, V.A., Kostyna, A.N., Kufin, A.N., Myasnikov, V.E., Nichiporenko, V.O., Popov, L.G., Zapevalov, V.E., Zakirov, F.G., 1995, Long-pulse 110 GHz/1MW gyrotron. Conf. Digest 20th Int. Conf. on Infrared and Millimeter Waves, Lake Buena Vista (Orlando), Florida, 205-206.
- [415] Myasnikov, V.E., Agapova, M.V., Alikae, V.V., Bogdashov, A.A., Borshegovsky, A.A., Denisov, G.G., Flyagin, V.A., Fix, A.Sh., Ilyin, V.I., Ilyin, V.N., Khmara, V.A., Khmara, D.V., Kostyna, A.N., Nichiporenko, V.O., Popov, L.G., Zapevalov, V.E., 1997, Long-pulse operation of 110 GHz 1 MW gyrotron. Conf. Digest 22nd Int. Conf. on Infrared and Millimeter Waves, Wintergreen, Virginia, USA, 102-103.

- [416] Myasnikov, V.E., Agapova, M.V., Alikae, V.V., Borshchegovsky, A.S., Denisov, G.G., Flyagin, V.A., Fix, A.Sh., Ilyin, V.I., Ilyin, V.N., Keyer, A.P., Khmara, V.A., Khmara, D.V., Kostyna, A.N., Nichiporenko, V.O., Popov, L.G., Zapevalov, V.E., 1996, Megawatt power level long-pulses 110 GHz and 140 GHz gyrotrons. Proc. 3rd Int. Workshop on Strong Microwaves in Plasmas, Nizhny Novgorod, 1997, **Vol.2**, 577-598.
- [417] Zapevalov, V.E., 1996, Achievement of stable operation of powerful gyrotrons for fusion. Proc. 3rd Int. Workshop on Strong Microwaves in Plasmas, Nizhny Novgorod, 1997, Vol.2, 599-613 and private communications.
- [418] Glyavin, M.Yu., Kuftin, A.N., Venediktov, N.P., Zapevalov, V.E., 1997, Experimental investigation of a 110 GHz/1 MW gyrotron with the one-step depressed collector. Int. J. Infrared and Millimeter Waves, **18**, 2129-2136.
- [419] Myasnikov, V.E., Agapova, M.V., Nichiporenko, V.O., Popov, L.G., Usachev, S.V., Iljin, V.N., Khmara, V.A., Litvak, A.G., Denisov, G.G., Zapevalov, V.E., Flyagin, V.A., Fix, A.Sh., Alikae, V.V., Iljin, V.I., 1999, Development of 1-MW long-pulse/CW gyrotrons in 110-170 GHz frequency range. Proc. Int. University Conf. "Electronics and Radiophysics of Ultra-High Frequencies" (UHF-99), 1999, St. Petersburg, Russia, 138-141.
- [420] Myasnikov, V.E., Agapova, M.V., Nichiporenko, V.O., Popov, L.G., Usachev, S.V., Iljin, V.N., Khmara, V.A., Litvak, A.G., Denisov, G.G., Zapevalov, V.E., Flyagin, V.A., Fix, A.Sh., Alikae, V.V., Iljin, V.I., 1999, Development of 1-MW long-pulse/CW gyrotrons in 110-170 GHz frequency range. Proc. 4th Int. Workshop on Strong Microwaves in Plasmas, Nizhny Novgorod, ed. A.G. Litvak, Inst. of Applied Physics, Russian Academy of Sciences, Nizhny Novgorod, 2000, **Vol. 2**, 610-614.
- [421] Denisov, G.G., 1999, Development of 1 MW output power level gyrotrons for fusion systems. Proc. 4th Int. Workshop on Strong Microwaves in Plasmas, Nizhny Novgorod, ed. A.G. Litvak, Inst. of Applied Physics, Russian Academy of Sciences, Nizhny Novgorod, 2000, **Vol. 2**, 967-986.
- [422] Denisov, G.G., Zapevalov, V.E., Litvak, A.G., Myasnikov, V.E., 2003, Megawatt gyrotrons for ECR heating and current-drive systems in controlled-fusion facilities. Radiophysics and Quantum Electronics, **46**, 757-768.
- [423] Litvak, A.G., Denisov, G.G., Myasnikov, V.E., Tai, E.M, 2005, Recent results in Gycom/IAP development of high-power gyrotrons for fusion installations. Conf. Digest 30th Int. Conf. on Infrared and Millimeter Waves and 13th Int. Conf. on Terahertz Electronics, Williamsburg, VA, USA, 233-234.
- [424] Denisov, G.G., Kuftin, A.N., Malygin, V.I., Venediktov, N.P., Vinogradov, D.V., Zapevalov, V.E., 1992, 110 GHz gyrotron with a built-in high-efficiency converter. Int. J. Electronics, **72**, 1079-1091.
- [425] Venediktov, N.P., Glyavin, M.Y., Zapevalov, V.E., Kuftin, A.N., 1998, Experimental study of a 110-GHz/1-MW gyrotron with a single-stage depressed collector. Radiophysics and Quantum Electronics, **41**, 449-456.
- [426] Bogdashov, A.A., Chirkov, A.V., Denisov, G.G., Kuftin, A.N., Lygin, V.K., Moiseev, M.A., Zapevalov, V.E., 2000, Development of the step tunable 140/110 GHz 1 MW gyrotron for fusion. Conf. Digest 25th Int. Conf. on Infrared and Millimeter Waves, Beijing, P.R. China, 21-22, and, 2000, private communications.
- [427] Denisov, G.G., Belousov, V.I., Pavel'ev, A.B., Chirkov, A.V., Ilin, V.N., Kurbatov, V.I., Malygin, S.A., Myasnikov, V.E., Orlov, V.B., Soluyanov, E.A., Sokolov, E.V., Tai, D.M., 2006, Multi-frequency gyrotron with BN Brewster window. Conf. Digest 31st Int. Conf. on Infrared and Millimeter Waves and 14th Int. Conf. on Terahertz Electronics, Shanghai, China, 75.

- [428] Nichiporenko, V.O., Agapova, M.V., Denisov, G.G., Ilyin, V.I., Litvak, A.G., Malygin, S.A., Myasnikov, V.E., Popov, L.G., Solujanova, E.A., Zapevalov, V.E., Tai, E.M., 2006, State of the art of 1 MW/105-140 GHz/10 sec gyrotron project in GYCOM. Conf. Digest 31st Int. Conf. on Infrared and Millimeter Waves and 14th Int. Conf. on Terahertz Electronics, Shanghai, China, 338.
- [429] Nagashima, T., Sakamoto, K., Maebara, S., Tsuneoka, M., Okazaki, Y., Hayashi, K., Miyake, S., Kariya, T., Mitsunaka, Y., Itoh, Y., Sugawara, T., Okamoto, T., 1990, Test results of 0.5 MW gyrotron at 120 GHz and 1.5 MW at 2 GHz Klystron for fusion application. Proc. Int. Workshop on Strong Microwaves in Plasmas, Suzdal, Inst. of Applied Physics, Nizhny Novgorod, 1991, 739-750 and, Okazaki, Y., 1994, private communication, Toshiba, Ohtawara, Japan.
- [430] Sakamoto, K., Tsuneoka, M., Maebava, S., Kasugai, A., Fujita, H., Kikuchi, M., Yamamoto, T., Nagashima, T., Kariya, T., Okazaki, Y., Shirai, N., Okamoto, T., Hayashi, K., Mitsunaka, Y., Hirata, Y., 1992, Development of a high power gyrotron for ECH of tokamak plasma. Conf. Digest 17th Int. Conf. on Infrared and Millimeter Waves, Pasadena, SPIE **1929**, 188-189.
- [431] Sakamoto, K., Tsuneoka, M., Kasugai, A., Maebara, S., Nagashima, T., Imai, T., Kariya, T., Okazaki, Y., Shirai, N., Okamoto, T., Hayashi, K., Mitsunaka, Y., Hirata, Y., 1993, Development of a high power gyrotron for fusion application in JAERI. Proc. 2nd Int. Workshop on Strong Microwaves in Plasmas, Moscow - Nizhny Novgorod - Moscow, ed. A.G. Litvak, Inst. of Applied Physics, Nizhny Novgorod, 1994, **Vol. 2**, 601-615.
- [432] Sakamoto, K., Tsuneoka, M., Kasugai, A., Takahashi, K., Maebara, S., Imai, T., Kariya, T., Okazaki, Y., Hayashi, K., Mitsunaka, Y., Hirata, Y., 1994, Development of 110 GHz CPD gyrotron. Conf. Digest 19th Int. Conf. on Infrared and Millimeter Waves, Sendai, JSAP Catalog No.: **AP 941228**, 63-64.
- [433] Sakamoto, K., Tsuneoka, M., Kasugai, A., Imai, T., Kariya, T., Hayashi, K., Mitsunaka, Y., 1994, Major improvement of gyrotron efficiency with beam energy recovery. Phys. Rev. Lett., **73**, 3532-3535.
- [434] Hayashi, K., Hirata, Y., Mitsunaka, Y., 1996, Startup analysis of a gyrotron power supply system for depressed-collector operation. Proc. 21st Int. Conf. on Infrared and Millimeter Waves, Berlin, AM11.
- [435] Sakamoto, K., Kasugai, A., Tsuneoka, M., Takahashi, K., Ikeda, Y., Imai, T., Kariya, T., Mitsunaka, Y., 1998, Development of high power gyrotron with diamond window. Conf. Digest 23rd Int. Conf. on Infrared and Millimeter Waves, Colchester, UK, 363-364, and private communications.
- [436] Sakamoto, K., Kasugai, A., Takahashi, K., Tsunenoka, M., Ikeda, Yu., Ikeda, Yo., Imai, T., Kariya, T., Mitsunaka, Y., 1999, Status of high power gyrotron development for fusion application in JAERI. Conf. Digest 24th Int. Conf. on Infrared and Millimeter Waves, Monterey, California, USA, TU-A1.
- [437] Fujii, T., Imai, T., 1999, Development of ECRF components and system for ITER and JT-60U tokamak. Proc. 4th Int. Workshop on Strong Microwaves in Plasmas, Nizhny Novgorod, ed. A.G. Litvak, Inst. of Applied Physics, Russian Academy of Sciences, Nizhny Novgorod, 2000, **Vol. 2**, 615-628.
- [438] Sakamoto, K., Kasugai, A., Shoyama, H., Hayashi, K., Takahashi, K., Tsuneoka, M., Ikeda, Yu., Ikeda, Yo., Kajiwarra, K., Moriyama, S., Seki, M., Fujii, T., Kariya, T., Mitsunaka, Y., Imai, T., 2000, Development of 100 GHz band gyrotrons and its application for JT-60U and ITER. Conf. Digest 25th Int. Conf. on Infrared and Millimeter Waves, Beijing, P.R. China, 11-12.
- [439] Kajiwarra, K., Ikeda, Y., Sakamoto, K., Kasugai, A., Seki, M., Moriyama, S., Takahashi, K., Imai, T., Mitsunaka, Y., Fujii, T., 2003, High power operation of 110 GHz gyrotron at 1.2 MW on the JT-60 ECRF system. Fusion Eng. and Design, **65**, 493-499.

- [440] Kasugai, A., Sakamoto, K., Takahashi, K., Kajiwara, K., Shoyama, H., Ikeda, Yu., Tsuneoka, M., Ikeda, Y., Fujii, T., Kariya, T., Mitsunaka, Y., Imai, T., 2001, 1 MW and long pulse operation of Gaussian beam output gyrotron with CVD diamond window for fusion devices. *Fusion and Engineering and Design*, **53**, 399-406.
- [441] Sakamoto, K., Kasugai, A., Ikeda, Y., Hayashi, K., Takahashi, K., Tsuneoka, M., Kariya, T., Mitsunaka, Y., Imai, T., 2002, Development of 170 GHz and 110 GHz gyrotron for fusion application. *Proc. 3rd IEEE Int. Vacuum Electronics Conf. (IVEC 2002)*, Monterey, USA, 336-337, and private communications, 2002.
- [442] Sakamoto, K., 2003, Development of gyrotron and application to fusion research. *Conf. Digest 28th Int. Conf. on Infrared and Millimeter Waves*, Otsu, Japan, 11-12.
- [443] Sakamoto, K., Kasugai, A., Ikeda, Y., Hayashi, K., Takahashi, K., Moriyama, S., Seki, M., Kariya, T., Mitsunaka, Y., Fujii, T., Imai, T., 2003, Development of 170 and 110 GHz gyrotrons for fusion devices. *Nucl. Fusion*, **43**, 729-737.
- [444] Fujii, T., Seki, M., Moriyama, S., Terakado, M., Shinozaki, S., Hiranai, S., Shimono, S., Hasegawa, K., Yokokura, K., and the JT-60 team, 2005, Operational progress of the 110 GHz-4 MW ECRF heating system in JT-60U. *Journal of Physics: Conference Series*, **25**, 45-50.
- [445] Moriyama, S., Kobayashi, T., Isayama, A., and the JT-60 RF heating group, 2009, Development of linear motion antenna and 110 GHz gyrotron for 7 MW electron cyclotron range of frequency system in JT-60SA tokamak, *Proc. 34th Int. Conf. on Infrared, Millimeter and Terahertz Waves*, Busan, Korea, M5E47.0442.
- [446] Kobayashi, T., Moriyama, S., Seki, M., Sawahata, M., Terakado, M., Fujii, T., 2008, Achievement of 1.5 MW, 1 s oscillation by the JT-60U gyrotron, *Plasma and Fusion Research: Rapid Communications*, **3**, 014-1 – 014-3.
- [447] Kobayashi, T., Terakado, M., Sato, F., Yokokura, K., Shimono, Hasegawa, K., Sawahata, M., Suzuki, S., Hiranai, S., Igarashi, K., Wada, K., Suzuki, T., Kajiwara, K., Kasugai, A., Sakamoto, K., Isayama, A., Mitsuunaga, G., Moriyama, S., 2009, Development of high power gyrotron and power modulation technique using the JT-60U ECRF system, *Plasma and Fusion Research: Regular Articles*, **4**, 037-1 – 037-10.
- [448] Kobayashi, T., Isayama, K., Yokokura, K., Shimono, M., Hasegawa, K., Sawahata, M., Suzuki, S., Terakado, M., Hiranai, S., Sato, F., Wada, K., Hinata, J., Sato, Y., Ohzeki, M., Takahashi, K., Kajiwara, K., Oda, Y., Kasugai, A., Sakamoto, K., Hoshino, K., Moriyama, S., 2011, Progress of high-power and long-pulse ECRF system development in JT-60, *Nuclear Fusion*, **51**, 103037 (10 pp).
- [449] Sakamoto, K., Kajiwara, K., Oda, Y., Takahashi, K., Hayashi, K., 2011, Progress of gyrotron development in JAEA, *Proc. 8th Int. Workshop Strong Microwaves and Terahertz Waves: Sources and Applications*, Nizhny Novgorod – St. Petersburg, Russia, July 9-16, 2011, pp. 35-36.
- [450] Sakamoto, K., Kajiwara, K., Oda, Y., Takahashi, K., Hayashi, K., Kobayashi, N., 2011, Development of high power long pulse gyrotron in JAEA, *Proc. 36th Int. Conf. on Infrared, Millimeter and Terahertz Waves (IRMMW-THz 2011)*, Houston, TX, USA, W4A.5.
- [451] Kobayashi, T., Isayama, A., Sawahata, M., Suzuki, S., Terakado, M., Hiranai, S., Wada, K., Sato, Y., Hinata, J., Yokokura, K., Hoshino, K., Kajiwara, K., Sakamoto, K., Moriyama, S., 2012, Dual frequency gyrotron development for JT-60SA, *38th Int. Conf. on Infrared, Millimeter and Terahertz Waves (IRMMW-THz 2012)*, Wollongong, Australia, Sept 23-28, 2012, Mon-A-3-5.
- [452] Shimosuma, T., Kikunaga, T., Asano, H., Yasojima, Y., Miyamoto, K., Tsukamoto, T., 1993, A 120 GHz high-power whispering-gallery mode gyrotron. *Int. J. Electronics*, **74**, 137-151.
- [453] Asano, H., Kikunagu, T., Shimosuma, T., Yasojima, Y., Tsukamoto, T., 1994, Experimental results of a 1 Megawatt gyrotron. *Conf. Digest 19th Int. Conf. Of Infrared and Millimeter Waves*, Sendai, JSAP Catalog No.: **AP 941228**, 59-60.

- [454] Giguet, E., Dubrovin, A., Krieg, J.M., Thouvenin, Ph., Tran, C., Garin, P., Pain, M., Alberti, S., Tran, M.Q., Whaley, D.R., Borie, E., Braz, O., Möbius, A., Piosczyk, B., Thumm, M., Wien, A., 1995, Operation of a 118 GHz - 0.5 MW gyrotron with cryogenic window: design and long pulse experiments. Conf. Digest 20th Int. Conf. on Infrared and Millimeter Waves, Lake Buena Vista (Orlando), Florida, 339-340.
- [455] Alberti, S., Braz, O., Garin, P., Giguet, E., Pain, M., Thouvenin, P.H., Thumm, M., Tran, C., Tran, M.Q., 1996, Long pulse operation of a 0.5 MW - 118 GHz gyrotron with cryogenic window. Proc. 21st Int. Conf. on Infrared and Millimeter Waves, Berlin, AF1.
- [456] Pain, M., Garin, P., Tran, M.Q., Alberti, S., Thumm, M., Braz, O., Giguet, E., Thouvenin, P., Tran, C., 1996, Status of the 118 GHz - quasi-CW gyrotron of the Tore Supra and TCV tokamaks. Fusion Technology, **1996**, eds., C. Varandas, F. Serra. Elsevier Science Publishers B.V., 1997, 533-536.
- [457] Alberti, S., Arnold, A., Borie, E., Dammertz, G., Erckmann, V., Garin, P., Giguet, E., Illy, S., Le Cloarec, G., Le Goff, Y., Magne, R., Michel, G., Piosczyk, B., Thumm, M., Tran, C., Tran, M.Q., Wagner, D., 2001, European high-power CW gyrotron development for ECRH systems. Fusion Engineering and Design, **53**, 387-397.
- [458] Darbos, C., Magne, R., Alberti, S., Barbuti, A., Berger-By, G., Bouquey, F., Cara, P., Clary, J., Courtois, L., Dumont, R., Giguet, E., Gil, D., Giruzzi, G., Jung, M., Le Goff, Y., Legrand, F., Lennholm, M., Liévin, C., Peysson, Y., Roux, D., Thumm, M., Wagner, T., Tran, M.Q., Zou, X., 2001, The 118 GHz ECRH experiment on Tore Supra. Fusion Eng. and Design, **56-57**, 605-609.
- [459] Magne, R., Alberti, S., Barbuti, A., Bouquey, F., Clary, J., Darbos, C., Giguet, E., Hogge, J.Ph., Jung, M., Le Goff, Y., Lennholm, M., Liévin, Ch., Portafaix, Ch., Roux, D., Saoutic, B., Thumm, M., 2001, Very long pulse testing of the TH 1506 B 118 GHz gyrotron. Proc. 14th Top. Conf. on Radio Frequency Power in Plasmas, Oxnard, California, AIP Conference Proceedings, **Vol. 595**, 477-481.
- [460] Magne, R., Bouquey, F., Clary, J., Darbos, C., Jung, M., Lambert, R., Lennholm, M., Roux, D., Alberti, A., Hogge, J.P., Bariou, D., Legrand, F., Liévin, C., Arnold, A., Thumm, M., 2004, Improvement of the gyrotron TH 1506B for tore supra. 5th IEEE Int. Vacuum Electronics Conf. (IVEC 2004), Monterey, CA, USA, 32-33.
- [461] Darbos, C., Alberti, S., Arnold, A., Bariou, D., Bouquey, F., Clary, J., Hogge, J.P., Lennholm, M., Liévin, C., Magne, R., Thumm, M., 2004, New design of the gyrotron used for ECRH experiments on Tore Supra. Proc. 13th Joint Workshop on Electron Cyclotron Emission and Electron Cyclotron Heating (EC13), ed. A. Litvak, Inst. of Applied Physics, Russian Academy of Sciences, Nizhny Novgorod, 2005, 409-414.
- [462] Darbos, C., Arnold, A., Prinz, H.O., Thumm, M., Bouquey, F., Hogge, H.P., Lambert, R., Liévin, C., Magne, R., Traisne, E., 2007, Upgrade of the TH1506B 118 GHz gyrotron using modelling tools, Proc. 17th Topical Conf. on Radio Frequency Power in Plasmas, Clearwater, Florida, USA, AIP Conf. Proc., Vol. 933, 425-428.
- [463] Prinz, H.O., Arnold, A., Dammertz, G., Thumm, M., 2007, Analysis of a TE_{22,6} 118-GHz quasi-optical mode converter, IEEE Trans. on Microwave Theory and Techniques, **55**, 1697-1703.
- [464] Darbos, C., Magne, R., Arnold, A., Prinz, H.O., Thumm, M., Bouquey, F., Hogge, J.P., Lambert, R., Lennholm, M., Liévin, C., Traisnel, E., 2009, The 118-GHz electron cyclotron heating system on Tore Supra, Fusion Science and Technology, **56**, 1205-1218.
- [465] Blank, M., Felch, K., Borchard, P., Cahalan, P., Cauffman, S., Chu, T.S., Jory, H., 2003, Development of a 140 GHz, 1 MW, long-pulse gyrotron oscillator. Conf. Digest 28th Int. Conf. on Infrared and Millimeter Waves, Otsu, Japan, 123-124.
- [466] Jory, H., Blank, M., Borchard, P., Cahalan, P., Cauffman, S., Chu, T.S., Felch, K., 2003, Test results for a 140 GHz, 1 MW gyrotron. Proc. 6th Workshop of High Energy Density and High Power RF, Berkeley Springs, West Virginia, 224-233.

- [467] Blank, M., Felch, K., Borchard, P., Cahalan, P., Cauffman, S.R., Chu, T.S., Jory, H., 2004, Demonstration of a high-power long-pulse 140-GHz gyrotron oscillator. *IEEE Trans. on Plasma Science*, **PS-32**, 867-876.
- [468] Felch, K., Blank, M., Borchard, P., Cahalan, P., Cauffman, S., Chu, T.S., Jory, H., 2005, Recent ITER-relevant gyrotron tests. *Journal of Physics: Conference Series*, **25**, 13-23.
- [469] Borie, E., Gantenbein, G., Jödicke, B., Dammertz, G., Dumbrajs, O., Geist, T., Hochschild, G., Kuntze, M., Nickel, H.-U., Piosczyk, B., Thumm, M., 1992, Mode competition using TE₀₃ gyrotron cavities. *Int. J. Electronics*, **72**, 687-720.
- [470] Dammertz, G., Haubrich, G., Hochschild, G., Jödicke, B., Kitlinski, M., Kuntze, M., Möbius, A., Piosczyk, B., Stickel, H., 1988, First experimental results of the KfK 150 GHz gyrotron. *Int. J. Electronics*, **64**, 29-36.
- [471] Gantenbein, G., Borie, E., Möbius, A., Piosczyk, B., Thumm, M., 1991, Design of a high-power 140 GHz gyrotron oscillator operating in an asymmetric volume mode at KfK. *Conf. Digest 16th Int. Conf. on Infrared and Millimeter Waves, Lausanne, Proc.*, SPIE **1576**, 264-265.
- [472] Piosczyk, B., Kuntze, M., Borie, E., Dammertz, G., Dumbrajs, O., Gantenbein, G., Möbius, A., Nickel H.-U., Thumm, M., 1992, Development of high power 140 GHz gyrotrons at KfK for applications in fusion. *Fusion Technology* **1992**, eds. C. Ferro, M. Gasparotto, H. Knoepfel. Elsevier Science Publishers B.V., 1993, 618-622.
- [473] Gantenbein, G., Borie, E., Dumbrajs, O., Thumm, M., 1995, Design of a high order volume mode cavity for a 1 MW/140 GHz gyrotron. *Int. J. Electronics*, **78**, 771-782.
- [474] Dammertz, G., Braz, O., Iatrou, C.T., Kuntze, M., Möbius, A., Piosczyk, B., Thumm, M., 1996, Long-pulse operation of a 0.5 MW TE_{10,4} gyrotron at 140 GHz. *IEEE Trans. on Plasma Science*, **PS-24**, 570-578.
- [475] Piosczyk, B., Iatrou, C.T., Dammertz, G., Thumm, M., 1996, Single-stage depressed collectors for gyrotrons. *IEEE Trans. on Plasma Science*, **PS-24**, 579-585.
- [476] Dammertz, G., Braz, O., Kuntze, M., Piosczyk, B., Thumm, M., 1996, Design criteria for step tunable long-pulse gyrotrons. *Proc. 3rd Int. Workshop on Strong Microwaves in Plasmas, Nizhny Novgorod, 1997*, **Vol.2**, 660-666.
- [477] Dammertz, G., Braz, O., Kuntze, M., Piosczyk, B., Thumm, M., 1997, Influence of window reflections on gyrotron operation. *Conf. Digest 22nd Int. Conf. on Infrared and Millimeter Waves, Wintergreen, Virginia, USA*, 150-151.
- [478] Kuntze, M., Borie, E., Dammertz, G., Piosczyk, B., Thumm, M., 1999, 140 GHz gyrotron with 2.1 output power. *Conf. Digest 24th Int. Conf. on Infrared and Millimeter Waves, Monterey, California, USA*, W-A6.
- [479] Dammertz, G., Borie, E., Iatrou, C.T., Kuntze, M., Piosczyk, B., Thumm, M.K, 2000, 140-GHz gyrotron with multimewatt output power. *IEEE Trans. on Plasma Science*, **PS-28**, 561-566.
- [480] Piosczyk, B., Borie, E., Braz, O., Dammertz, G., Iatrou, C.T., Illy, S., Kern, S., Kuntze, M., Kartikeyan, M.V., Michel, G., Möbius, A., Thumm, M., 1996, Advanced high power gyrotrons for ECW application. *Fusion Technology* **1996**, eds., C. Varandas, F. Serra. Elsevier Science Publishers B.V., 1997, 545-548.
- [481] Kuntze, M., Borie, E., Braz, O., Dammertz, G., Illy, S., Michel, G., Möbius, A., Piosczyk, B., Thumm, M., 1998, Advanced high power gyrotrons for ECRH applications. *Proc. 20th Int. Symp. on Fusion Technology (SOFT), Marseille, France, Vol. 1*, 489-492.
- [482] Piosczyk, B., Arnold, A., Borie, E., Dammertz, G., Drumm, O., Dumbrajs, O., Illy, S., Kuntze, M., Koppenburg, K., Schmid, M., Thumm, M., 2001, Progress in the development of advanced high power gyrotrons. *Proc. 2nd IEEE Int. Vacuum Electronics Conf. (IVEC 2001), Noordwijk, Netherlands*, 327-330.

- [483] Piosczyk, B., Arnold, A., Borie, E., Dammertz, G., Drumm, O., Dumbrajs, O., Illy, S., Kuntze, M., Koppenburg, K., Schmid, M., Thumm, M., 2001, Advanced high power gyrotrons for fusion applications. Proc. 9th Int. Conf. Displays and Vacuum Electronics, Garmisch-Partenkirchen, ITG-Fachbericht **165**, 149-152.
- [484] Piosczyk, B., Arnold, A., Borie, E., Dammertz, G., Drumm, O., Dumbrajs, O., Illy, S., Kuntze, M., Koppenburg, K., Thumm, M., 2001, Development of advanced high power gyrotrons at Forschungszentrum Karlsruhe. Frequenz, **55**, 242-246.
- [485] Kuntze, M., Alberti, S., Dammertz, G., Giguet, E., Illy, S., Heidinger, R., Koppenburg, K., LeCloarec, G., LeGoff, Y., Leonhardt, W., Piosczyk, B., Schmid, M., Thumm, M.K., Tran, M.Q., 2003, Advanced high power gyrotrons. IEEE Trans. on Plasma Science, **PS-31**, 25-31.
- [486] Dammertz, G., Alberti, S., Arnold, A., Borie, E., Erckmann, V., Gantenbein, G., Giguet, E., Heidinger, R., Hogge, J.P., Illy, S., Kasperek, W., Koppenburg, K., Kuntze, M., Laqua, H., LeCloarec, G., Legrand, F., LeGoff, Y., Leonhardt, W., Lievin, C., Magne, R., Michel, G., Müller, G., Neffe, G., Piosczyk, B., Rzesnicki, T., Schmid, M., Thumm, M., Tran, M.Q., 2004, Development of multimewatt gyrotrons for fusion plasma heating and current drive. 5th IEEE Int. Vacuum Electronics Conf. (IVEC 2004), Monterey, CA, USA, 28-29.
- [487] Dammertz, G., Alberti, S., Arnold, A., Borie, E., Erckmann, V., Förster, W., Gantenbein, G., Garin, P., Giguet, E., Illy, S., Kasperek, W., Laqua, H., Le Cloarec, G., Le Goff, Y., Leonhardt, W., Magne, R., Michel, G., Müller, G., Kuntze, M., Piosczyk, B., Schmid, M., Thumm, M., Tran, M.Q., 2001, 1 MW, 140 GHz, CW gyrotron for Wendelstein 7-X. Proc. 9th Int. Conf. Displays and Vacuum Electronics, Garmisch-Partenkirchen, ITG-Fachbericht **165**, 143-147.
- [488] Dammertz, G., Alberti, S., Arnold, A., Borie, E., Erckmann, V., Gantenbein, G., Giguet, E., Hogge, J.-P., Illy, S., Kasperek, W., Koppenburg, K., Laqua, H., Le Cloarec, G., Le Goff, Y., Leonhardt, W., Liévin, Ch., Magne, R., Michel, G., Müller, G., Neffe, G., Kuntze, M., Piosczyk, B., Schmid, M., Thumm, M., Tran, M.Q., 2001, Development of a 140 GHz, 1 MW, continuous wave gyrotron for the W7-X stellarator. Frequenz, **55**, 270-275.
- [489] Dammertz, G., Alberti, S., Arnold, A., Borie, E., Erckmann, V., Gantenbein, G., Giguet, E., Heidinger, R., Hogge, J.P., Illy, S., Kasperek, W., Koppenburg, K., Kuntze, M., Laqua, H.P., LeCloarec, G., LeGoff, Y., Leonhardt, W., Lievin, C., Magne, R., Michel, G., Müller, G., Neffe, G., Piosczyk, B., Schmid, M., Schwörer, K., Thumm, M.K., Tran, M.Q., 2002, Development of a 140-GHz 1-MW continuous wave gyrotron for the W7-X stellarator. IEEE Trans. on Plasma Science, **PS-30**, 808-818.
- [490] Dammertz, G., Alberti, S., Arnold, A., Borie, E., Erckmann, V., Gantenbein, G., Giguet, E., Heidinger, R., Hogge, J.P., Illy, S., Kasperek, W., Koppenburg, K., Kuntze, M., Laqua, H., LeCloarec, G., Legrand, F., LeGoff, Y., Leonhardt, W., Lievin, C., Magne, R., Michel, G., Müller, G., Neffe, G., Piosczyk, B., Schmid, M., Thumm, M., Tran, M.P., 2002, 140 GHz, 1 MW, CW gyrotron for fusion plasma heating. Proc. 3rd IEEE Int. Vacuum Electronics Conf. (IVEC 2002), Monterey, USA, 330-331.
- [491] Dammertz, G., Alberti, S., Arnold, A., Borie, E., Erckmann, V., Gantenbein, G., Giguet, E., Heidinger, R., Hogge, J.P., Illy, S., Kasperek, W., Koppenburg, K., Kuntze, M., Laqua, H.P., LeCloarec, G., Legrand, F., Leonhardt, W., Lievin, C., Magne, R., Michel, G., Müller, G., Neffe, G., Piosczyk, B., Schmid, M., Schwörer, K., Thumm, M., Tran, M.Q., 2002, Progress of the 1 MW, 140 GHz, CW gyrotron for W7-X. Proc. 27th Int. Conf. on Infrared and Millimeter Waves, San Diego, USA, 3-4.

- [492] Dammertz, G., Alberti, S., Arnold, A., Borie, E., Erckmann, V., Gantenbein, G., Giguet, E., Heidinger, R., Hogge, J.P., Illy, S., Kasperek, W., Koppenburg, K., Kuntze, M., Laqua, H.P., LeCloarec, G., LeGoff, Y., Leonhardt, W., Lievin, C., Magne, R., Michel, G., Müller, G., Neffe, G., Piosczyk, B., Schmid, M., Thumm, M., Tran, M.Q., 2002, Status of the 1 MW, 140 GHz gyrotron for W7-X. Proc. 5th Int. Workshop on Strong Microwaves in Plasmas, Nizhny Novgorod, ed. A.G. Litvak, Inst. of Applied Physics, Russian Academy of Sciences, Nizhny Novgorod, 2003, **Vol. 1**, 16-28.
- [493] Dammertz, G., Alberti, S., Fasel, D., Giguet, E., Koppenburg, K., Kuntze, M., Legrand, F., Leonhardt, W., Lievin, C., Müller, G., Neffe, G., Piosczyk, B., Schmid, M., Sterk, A., Thumm, M., Tran, M.Q., Verhoeven, A.G.A., 2003, Power modulation capabilities of the 140 GHz/1MW gyrotron for the stellarator Wendelstein 7-X. Fusion Engineering and Design, **66-68**, 497-502.
- [494] Dammertz, G., Alberti, S., Arnold, A., Borie, E., Erckmann, V., Gantenbein, G., Giguet, E., Heidinger, R., Hogge, J.P., Illy, S., Kasperek, W., Koppenburg, K., Kuntze, M., Laqua, H., LeCloarec, G., Legrand, F., LeGoff, Y., Leonhardt, W., Lievin, C., Magne, R., Michel, G., Müller, G., Neffe, G., Piosczyk, B., Schmid, M., Thumm, M., Tran, M.Q., 2003, Progress in the development of a 1-MW, CW gyrotron at 140 GHz for fusion plasma heating. 4th IEEE Int. Vacuum Electronics Conf. (IVEC 2003), Seoul, Korea, 34-35.
- [495] Dammertz, G., Alberti, S., Arnold, A., Borie, E., Erckmann, V., Gantenbein, G., Giguet, E., Heidinger, R., Hogge, J.P., Illy, S., Kasperek, W., Koppenburg, K., Kuntze, M., Laqua, H.P., LeCloarec, G., Legrand, F., Leonhardt, W., Liévin, C., Magne, R., Michel, G., Müller, G., Neffe, G., Piosczyk, B., Schmid, M., Schwoerer, K., Thumm, M., Tran, M.Q., 2003, Prototype of a 1 MW, CW gyrotron at 140 GHz for Wendelstein 7-X. Conf. Digest 28th Int. Conf. on Infrared and Millimeter Waves, Otsu, Japan, 121-122.
- [496] Dammertz, G., Alberti, S., Arnold, A., Borie, E., Erckmann, V., Gantenbein, G., Giguet, E., Heidinger, R., Hogge, J.P., Illy, S., Kasperek, W., Koppenburg, K., Kuntze, M., Laqua, H.P., LeCloarec, G., Legrand, F., Leonhardt, W., Liévin, C., Magne, R., Michel, G., Müller, G., Neffe, G., Piosczyk, B., Schmid, M., Schwörer, K., Thumm, M., Tran, M.Q., 2004, The 140-GHz 1-MW CW gyrotron for the Stellarator W7-X, Proc. 10th Int. Conf. Displays and Vacuum Electronics, Garmisch-Partenkirchen, ITG-Fachbericht **183**, 35-39.
- [497] Dammertz, G., Alberti, S., Arnold, A., Brand, P., Braune, H., Borie, E., Erckmann, V., Gantenbein, G., Giguet, E., Heidinger, R., Hogge, J.-P., Illy, S., Kasperek, W., Koppenburg, K., Kuntze, M., Laqua, H., LeCloarec, G., Legrand, F., Leonhardt, W., Liévin, C., Magne, R., Michel, G., Müller, G., Neffe, G., Piosczyk, B., Schmid, M., Schwörer, K., Thumm, M., Tran, M.Q., 2004, Progress in the development of 1 MW CW gyrotrons for the stellarator W7-X. Proc. 13th Joint Workshop on Electron Cyclotron Emission and Electron Cyclotron Heating (EC13), ed. A. Litvak, Inst. of Applied Physics, Russian Academy of Sciences, Nizhny Novgorod, 2005, 371-376.
- [498] Dammertz, G., Alberti, S., Arnold, A., Borie, E., Brand, P., Braune, H., Erckmann, V., Gantenbein, G., Giguet, E., Heidinger, R., Hogge, J.P., Illy, S., Kasperek, W., Koppenburg, K., Kuntze, M., Laqua, H., LeCloarec, G., Legrand, F., Leonhardt, W., Lievin, C., Magne, R., Michel, G., Müller, G., Neffe, G., Piosczyk, B., Schmid, M., Thumm, M., Tran, M.Q., 2004, Status of the 1 MW, CW gyrotrons for the stellarator W7-X. Conf. Digest 29th Int. Conf. on Infrared and Millimeter Waves and 12th Int. Conf. on Terahertz Electronics, Karlsruhe, Germany, 113-114.
- [499] Dammertz, G., Alberti, S., Bariou, D., Brand, P., Braune, H., Erckmann, V., Gantenbein, G., Giguet, E., Heidinger, R., Hogge, J.P., Kasperek, W., Laqua, H.P., Liévin, C., Leonhardt, W., Michel, G., Müller, G., Neffe, G., Piosczyk, P., Schmid, M., Thumm, M., 2005, 140 GHz high-power gyrotron development for the stellarator W7-X. Fusion Eng. and Design, **74**, 217-221.

- [500] Dammertz, G., 2005, Development of a 1-MW, CW gyrotron at 140 GHz for electron-cyclotron-resonance-heating in fusion plasma devices. Proc. 6th IEEE Int. Vacuum Electronics Conf. (IVEC 2005), Noordwijk, The Netherlands, 113.
- [501] Dammertz, G., Alberti, S., Arnold, A., Bariou, D., Borie, E., Brand, P., Braune, H., Erckmann, V., Gantenbein, G., Giguet, E., Heidinger, R., Hogge, J.P., Illy, S., Kasperek, W., Koppenburg, K., Laqua, H., Legrand, F., Leonhardt, W., Lievin, C., Michel, G., Müller, G., Neffe, G., Piosczyk, B., Schmid, M., Thumm, M., Tran, M.Q., 2005, Experimental results on the 140 GHz, 1 MW, CW gyrotrons for the stellarator W7-X. Conf. Digest 30th Int. Conf. on Infrared and Millimeter Waves and 13th Int. Conf. on Terahertz Electronics, Williamsburg, VA, USA, 235-236.
- [502] Dammertz, G., Alberti, S., Arnold, A., Bariou, D., Brand, P., Braune, H., Erckmann, V., Gantenbein, G., Giguet, E., Heidinger, R., Hogge, J.-P., Illy, S., Jin, J., Kasperek, W., Koppenburg, K., Laqua, H.P., Legrand, F., Leonhardt, W., Lievin, C., Magne, R., Michel, G., Müller, G., Neffe, G., Piosczyk, P., Rzesnicki, T., Schmid, M., Thumm, M., Tran, M.Q., Yang, X., 2005, Development of multimewatt gyrotrons for fusion plasma heating and current drive. IEEE Trans. on Electron Devices, **52**, No. 5, 808-817.
- [503] Gantenbein, G., Dammertz, G., Alberti, S., Arnold, A., Erckmann, V., Giguet, E., Heidinger, R., Hogge, J.P., Illy, S., Kasperek, W., Koppenburg, K., Laqua, H., Legrand, F., Leonhardt, W., Liévin, C., Michel, G., Neffe, G., Piosczyk, B., Schmid, M., Thumm, M., Tran, M.Q., 2006, Status of the 1-MW, 140-GHz, CW gyrotron for W7-X. Proc. Int. Vacuum Electronics Conference and Int. Vacuum Electron Sources (IVEC/IVESC 2006), Monterey, California, USA, 533-534.
- [504] Dammertz, G., Alberti, S., Arnold, A., Erckmann, V., Gantenbein, G., Giguet, E., Heidinger, R., Hogge, J.P., Illy, S., Kasperek, W., Laqua, H., Legrand, F., Leonhardt, W., Liévin, C., Michel, G., Neffe, G., Piosczyk, B., Schmid, M., Thumm, M., Tran, M.Q., 2006, Status of the series production of 1-MW, 140-GHz, CW gyrotrons for W7-X. Conf. Digest 31st Int. Conf. on Infrared and Millimeter Waves and 14th Int. Conf. on Terahertz Electronics, Shanghai, China, 21.
- [505] Thumm, M., Alberti, S., Arnold, A., Dammertz, G., Erckmann, V., Gantenbein, G., Giguet, E., Heidinger, R., Hogge, J.-P., Illy, S., Kasperek, W., Laqua, H.P., Lievin, C., Magne, R., Michel, G., Piosczyk, B., Schwörer, K., Tran, M.Q., Yang, X., 2005, Status of 1 MW, 140 GHz, CW gyrotron for W7-X. Proc. 6th Int. Workshop on Strong Microwaves in Plasmas, Nizhny Novgorod, ed. A.G. Litvak, Inst. of Applied Physics, Russian Academy of Sciences, Nizhny Novgorod, 2006, **Vol. 1**, 33-45.
- [506] Gantenbein, G., Dammertz, G., Erckmann, V., Illy, S., Kasperek, W., Lechte, C., Legrand, F., Lietaer, G., Liévin, C., Piosczyk, B., Schmid, M., Thumm, M., 2007, Experimental results on high-power gyrotrons for the stellarator W7-X. Conf. Digest 32nd Int. Conf. on Infrared and Millimeter Waves and 15th Int. Conf. on Terahertz Electronics, Cardiff, UK, 102-103.
- [507] Braune, H., Brand, P., Dammertz, G., Erckmann, V., Gantenbein, G., Kasperek, W., Laqua, H.P., Lechte, C., Leonhardt, W., Mellein, D., Michel, G., Noke, F., Purps, F., Schlüter, K.-H., Schmid, M., Thumm, M., and the W7-X ECRH Teams at IPP, IPF and FZK, 2007, Extended operation of the 1 MW, CW gyrotrons for W7-X. Conf. Digest 32nd Int. Conf. on Infrared and Millimeter Waves and 15th Int. Conf. on Terahertz Electronics, Cardiff, UK, 104-105.
- [508] Thumm, M., Alberti, A., Arnold, A., Brand, P., Braune, H., Dammertz, G., Erckmann, V., Gantenbein, G., Giguet, E., Heidinger, R., Hogge, J.P., Illy, S., Kasperek, W., Laqua, H.P., Legrand, F., Leonhardt, W., Liévin, C., Michel, G., Neffe, G., Piosczyk, B., Schmid, M., Schwörer, K., Tran, M.Q., 2007, EU megawatt-class 140-GHz CW gyrotron, IEEE Trans. on Plasma Science, **35**, 143-153.

- [509] Schmid, M., Illy, S., Dammertz, G., Erckmann, V., Thumm, M., 2007, Transverse field collector sweep system for high power CW gyrotrons, *Fusion Engineering and Design*, **82**, 744-750.
- [510] Thumm, M., Brand, P., Braune, H., Dammertz, G., Erckmann, V., Gantenbein, G., Illy, S., Kasperek, W., Laqua, H.P., Lechte, C., Leonhardt, W., Michel, G., Neffe, G., Piosczyk, B., Schmid, M., Weissgerber, M., 2008, Progress in the 10-MW 140-GHz ECH system for the stellarator W7-X, *IEEE Trans. on Plasma Science*, **36**, 341-355.
- [511] Thumm, M., Braune, H., Dammertz, G., Erckmann, V., Gantenbein, G., Illy, S., Kern, S., Kasperek, W., Laqua, H.P., Lechte, C., Legrand, F., Leonhardt, W., Lievin, C., Michel, G., Piosczyk, B., Prinz, O., Schmid, M., 2008, 1 MW, 140 GHz series gyrotrons for the W7-X stellarator, *Proc. 7th Int. Workshop on Strong Microwaves: Sources and Applications*, Nizhny Novgorod, ed. A.G. Litvak, Inst. of Applied Physics, Russian Academy of Sciences, Nizhny Novgorod, 2009, **Vol. 1**, pp. 84-94.
- [512] Braune, H., Erckmann, V., Illy, S., Laqua, H.P., Noke, F., Purps, F., Schmid, M., 2008, Advanced transverse field collectors sweeping for high power gyrotrons, *Proc. 7th Int. Workshop on Strong Microwaves: Sources and Applications*, Nizhny Novgorod, ed. A.G. Litvak, Inst. of Applied Physics, Russian Academy of Sciences, Nizhny Novgorod, 2009, **Vol. 1**, pp. 149-153.
- [513] Kern, S., Schlaich, A., Flamm, J., Gantenbein, G., Latsas, G., Rzesnicki, T., Samartsev, A., Thumm, M., Tigelis, I., 2009, Investigations on parasitic oscillations in megawatt gyrotrons, *Proc. 34th Int. Conf. on Infrared, Millimeter and Terahertz Waves*, Busan, Korea, T4C01.0132.
- [514] Gantenbein, G., Dammertz, G., Flamm, J., Illy, S., Kern, S., Latsas, G., Piosczyk, B., Rzesnicki, T., Samartsev, A., Schlaich, A., Thumm, M., Tigelis, I., 2010, Experimental investigations and analysis of parasitic RF oscillations in high-power gyrotrons, *IEEE Trans. on Plasma Science*, **38**, 1168-1177.
- [515] Schlaich, A., Flamm, J., Gantenbein, G., Kern, S., Latsas, G., Rzesnicki, T., Samartsev, A., Thumm, M., Tigelis, I., 2010, Investigations on parasitic oscillations in megawatt gyrotrons, *Proc. 11th IEEE Int. Vacuum Electronics Conference (IVEC 2010)*, Monterey, USA, pp. 33-34.
- [516] Gantenbein, G., Erckmann, V., Illy, S., Kern, S., Kasperek, W., Lechte, C., Leonhardt, W., Liévin, C., Samartsev, A., Schlaich, A., Schmid, M., Thumm, M., 2011, 140 GHz, 1 MW CW gyrotron development for fusion applications – Progress and recent results. *J. of Infrared, Millimeter, and Terahertz Waves*, **32**, 320-328.
- [517] Thumm, M., Gantenbein, G., Erckmann, V., Illy, S., Kern, S., Kasperek, W., Lechte, C., Leonhardt, W., Liévin, C., Samartsev, A., Schlaich, A., Schmid, M., 2011, 140 GHz, 1 MW, CW gyrotron development for the ECRH system of the stellarator Wendelstein 7-X, *Proc. 12th IEEE Int. Vacuum Electronics Conference (IVEC 2011)*, Bangalore, India, 10.1, Invited Keynote Talk, pp. 105-106.
- [518] Thumm, M., Braune, H., Dammertz, G., Gantenbein, G., Erckmann, V., Illy, S., Kern, S., Kasperek, W., Lechte, C., Leonhardt, W., Liévin, C., Michel, G., Noke, F., Purps, F., Samartsev, A., Schlaich, A., Schmid, M., Schulz, T., 2011, Recent progress on the 1 MW, 140 GHz, CW series gyrotrons for W7-X, *Proc. 8th Int. Workshop Strong Microwaves and Terahertz Waves: Sources and Applications*, Nizhny Novgorod – St. Petersburg, Russia, July 9-16, 2011, pp. 45-46.
- [519] Gantenbein, G., Braune, H., Dammertz, G., Erckmann, V., Illy, S., Kern, S., Kasperek, W., Lechte, C., Leonhardt, W., Lievin, C., Michel, G., Noke, F., Purps, F., Samartsev, A., Schlaich, A., Schmid, M., Thumm, M., 2011, Status of 1 MW, 140 GHz series gyrotrons for W7-X, *Proc. 36th Int. Conf. on Infrared, Millimeter and Terahertz Waves (IRMMW-THz 2011)*, Houston, TX, USA, W4A.1.

- [520] Jelonnek, J., Braune, H., Dammertz, G., Erckmann, V., Flamm, J., Gantenbein, G., Hollmann, F., Jonitz, L., Kasperek, W., Kern, S., Laqua, H.P., Lechte, C., Légrand, F., Leonhardt, W., Lietaer, G., Michel, G., Noke, F., Purps, F., Samartsev, A., Schlaich, A., Schmid, M., Thumm, M., Uhren, P., 2012, Progress on 140 GHz, 1 MW, CW series gyrotrons for W7-X, 38th Int. Conf. on Infrared, Millimeter and Terahertz Waves (IRMMW-THz 2012), Wollongong, Australia, Sept 23-28, 2012, Thu-A-2-2.
- [521] Myasnikov, V.E., Cayer, A.P., Bogdanov, S.D., Kurbatov, V.I., 1991, Soviet industrial gyrotrons. Conf. Digest 16th Int. Conf. on Infrared and Millimeter Waves, Lausanne, SPIE **1576**, 127-128.
- [522] Flyagin, V.A., Goldenberg, A.L., Zapevalov, V.E., 1993, State of the art of gyrotron investigation in Russia. Conf. Digest 18th Int. Conf. on Infrared and Millimeter Waves, Colchester (Essex, UK), Proc., SPIE **2104**, 581-584.
- [523] Denisov, G.G., Flyagin, V.A., Goldenberg, A.L., Khizhnyak, V.I., Kuftin, A.N., Malygin, V.I., Pavelyev, A.B., Pylin, A.V., Zapevalov, V.E., 1991, Investigation of gyrotrons in IAP. Conf. Digest 16th Int. Conf. on Infrared and Millimeter Waves, Lausanne, SPIE **1576**, 632-635.
- [524] Agapova, M.V., Axenova, L.A., Alikaev, V.V., Cayer, A.P., Denisov, G.G., Flyagin, V.A., Fix, A.Sh., Iljin, V.I., Ilyin, V.N., Khmara, V.A., Kostyna, A.N., Kuftin, A.N., Mjasnikov, V.E., Popov, L.G., Zapevalov, V.E., 1994, Long-pulsed 140 GHz/0.5 MW gyrotron: problems and results. Conf. Digest 19th Int. Conf. on Infrared and Millimeter Waves, Sendai, JSAP Catalog No.: **AP 941228**, 79-80.
- [525] Mjasnikov, V.E., Agapova, M.V., Alikaev, V.V., Borshchegovsky, A.S., Denisov, G.G., Fljagin, V.A., Fix, A.Sh., Ilyin, V.I., Ilyin, V.N., Keyer, A.P., Khmara, V.A., Khmara, D.V., Kostyna, A.N., Nichiporenko, V.O., Popov, L.G., Zapevalov, V.E., 1996, Megawatt power long-pulse 140 GHz gyrotron. Proc. 21st Int. Conf. on Infrared and Millimeter Waves, Berlin, ATH1.
- [526] Zapevalov, V.E., Alikaev, V.V., Denisov, G.G., Flyagin, V.A., Fix, A.Sh., Kuftin, A.N., Kurbatov, V.I., Myasnikov, V.E., 1997, Development of 1 MW output power level gyrotron for ITER. Conf. Digest 22nd Int. Conf. on Infrared and Millimeter Waves, Wintergreen, Virginia, USA, 108-109.
- [527] Denisov, G.G., Flyagin, V.A., Kuftin, A.N., Lygin, V.K., Moiseev, M.A., Zapevalov, V.E., 1996, Development of the prototype 170 GHz/ 1 MW gyrotron for ITER at IAP. Proc. 3rd Int. Workshop on Strong Microwaves in Plasmas, Nizhny Novgorod, 1997, **Vol. 2**, 717-722.
- [528] Myasnikov, V.E., Agapova, M.V., Kostyna, A.N., Popov, L.G., Denisov, G.G., Bogdashov, A.A., Zapevalov, V.E., 1998, Development of 140 GHz/ 1 MW gyrotron with a dual RF beam output. Conf. Digest 23rd Int. Conf. on Infrared and Millimeter Waves, Colchester, UK, 375-376.
- [529] Myasnikov, V.E., Agapova, M.V., Ilyin, V.N., Khmara, D.V., Kostyna, A.N., Nichiporenko, V.O., Popov, L.G., Zakirov, F.G., Shamanova, N.A., Alikaev, V.V., Ilyin, V.I., Denisov, G.G., Zapevalov, V.E., Bogdashov, A.A., Kuftin, A.N., Lygin, V.K., Litvak, A.G., Chirkov, A.V., Moiseev, M.A., 2001, Status of the 140 GHz / 800 kW / 3-10 s gyrotron for textor tokamak. Proc. 2nd IEEE Int. Vacuum Electronics Conf. (IVEC 2001), Noordwijk, Netherlands, 321-323.
- [530] Myasnikov, V.E., Usachev, S.V., Agapova, M.V., Alikaev, V.V., Denisov, G.G., Fix, A.Sh., Flyagin, V.A., Gnedenkov, A. Ph., Ilyin, V.I., Kuftin, A.N., Popov, L.G., Zapevalov, V.E., 1998, Long-pulse operation of 170 GHz/1 MW gyrotron for ITER. Conf. Digest 23rd Int. Conf. on Infrared and Millimeter Waves, Colchester, UK, 24-25.
- [531] Myasnikov, V.E., Litvak, A.G., Usachev, S.V., Popov, L.G., Agapova, M.V., Alikaev, V.V., Denisov, G.G., Gnedenkov, A. Ph., Ilyin, V.I., Ilyin, V.N., Khmara, D.V., Kostyna, A.N., Nichiporenko, V.O., Zapevalov, V.E., 1999, Development of 170 GHz gyrotron with depressed collector and diamond window for ITER. Conf. Digest 24th Int. Conf. on Infrared and Millimeter Waves, Monterey, California, USA, TU-A8.

- [532] Zapevalov, V.E., Denisov, G.G., Flyagin, V.A., Fix, A.Sh., Kuftin, A.N., Litvak, A.G., Agapova, M.V., Iljin, V.N., Khmara, V.A., Myasnikov, V.E., Nichiporenko, V.O., Popov, L.G., Usachev, S.V., Alikaev, V.V., Iljin, V.I., 2001, Development of 170 GHz / 1 MW Russian gyrotron for ITER. *Fusion Engineering and Design*, **53**, 377-385.
- [533] Myasnikov, V.E., Litvak, A.G., Usachev, S.V., Popov, L.G., Agapova, M.V., Alikaev, V.V., Denisov, G.G., Gnedenkov, A.Ph., Ilyin, V.I., Ilyin, V.N., Khmara, D.V., Kostyna, A.N., Nichiporenko, V.O., Zapevalov, V.E., 2002, Development of 170 GHz gyrotron for ITER. *Proc. 3rd IEEE Int. Vacuum Electronics Conf. (IVEC 2002)*, Monterey, USA, 334-335.
- [534] Denisov, G.G., 2002, Megawatt gyrotrons for fusion research. State of the art and trends of development. *Proc. 5th Int. Workshop on Strong Microwaves in Plasmas*, Nizhny Novgorod, ed. A.G. Litvak, Inst. of Applied Physics, Russian Academy of Sciences, Nizhny Novgorod, 2003, **Vol. 1**, 29-45.
- [535] Litvak, A.G., Denisov, G.G., 2003, Gyrotron oscillator for fusion reactor. *4th IEEE Int. Vacuum Electronics Conf. (IVEC 2003)*, Seoul, Korea, 352-353.
- [536] Denisov, G.G., Bogdashov, A.A., Belousov, V.I., Chirkov, A.V., Kalynova, G.I., Kuftin, A.N., Litvak, A.G., Lygin, V.K., Malygin, V.I., Moiseev, M.A., Zapevalov, V.E., Kurbatov, V.I., Malygin, S.A., Orlov, V.B., Tai, E.M., Ilyin, V.N., Popov, L.G., Myasnikov, V.E., Sokolov, E.V., Apagova, M.V., Usachev, S.V., Soluyanov, E.V., Gnedenkov, A.F., Khmara, D.V., Kostyna, A.N., Nichiporenko, V.O., Manuilov, V.N., Ilyin, V.I., 2003, New results in development of MW output power gyrotrons for fusion systems. *4th IEEE Int. Vacuum Electronics Conf. (IVEC 2003)*, Seoul, Korea, 28-29.
- [537] Zapevalov, V.E., Belousov, V.I., Bogdashov, A.A., Chirkov, A.V., Denisov, G.G., Kuftin, A.N., Litvak, A.G., Lygin, V.K., Malygin, V.I., Moiseev, M.A., Agapova, M.V., Gnedenkov, A.Ph., Iljin, V.N., Khmara, D.V., Kostyna, A.N., Myasnikov, V.E., Nichiporenko, V.O., Popov, L.G., Usachev, S.V., Roschin, Yu.V., Iljin, V.I., 2003, Evolution of 170 GHz/1 MW Russian gyrotron for ITER. *Conf. Digest 28th Int. Conf. on Infrared and Millimeter Waves*, Otsu, Japan, 165-166.
- [538] Usachev, S.V., Litvak, A.G., Myasnikov, V.E., Popov, L.G., Agapova, M.V., Nichiporenko, V.O., Denisov, G.G., Bogdashov, A.A., Gnedenkov, A.Ph., Ilyin, V.I., Ilyin, V.N., Khmara, D.V., Kostyna, A.N., Kuftin, A.N., Kurbatov, V.I., Lygin, V.K., Moiseev, M.A., Malygin, V.I., Zapevalov, V.E., Tai, E.M., 2004, Development of 170 GHz/1 MW/CW gyrotron for ITER. *Proc. 13th Joint Workshop on Electron Cyclotron Emission and Electron Cyclotron Heating (EC13)*, ed. A. Litvak, Inst. of Applied Physics, Russian Academy of Sciences, Nizhny Novgorod, 2005, 398-402.
- [539] Litvak, A.G., Myasnikov, V.E., Usachev, S.V., Popov, L.G., Agapova, M.V., Nichiporenko, V.O., Denisov, G.G., Bogdashov, A.A., Gnedenkov, A.Ph., Ilyin, V.I., Ilyin, V.N., Khmara, D.V., Kostyna, A.N., Kuftin, A.N., Lygin, V.K., Moiseev, M.A., Malygin, V.I., Solujanova, E.A., Zapevalov, V.E., Tai, E.M., 2004, Development of 170 GHz/1MW/50%/CW gyrotron for ITER. *Conf. Digest 29th Int. Conf. on Infrared and Millimeter Waves and 12th Int. Conf. on Terahertz Electronics*, Karlsruhe, Germany, 111-112.
- [540] Denisov, G.G., Litvak, A.G., Myasnikov, V.E., Tai, E.M., Ilin, V.I., Zapevalov, V.E., 2005, Megawatt-power gyrotrons for fusion. *Proc. 6th Int. Workshop on Strong Microwaves in Plasmas*, Nizhny Novgorod, ed. A.G. Litvak, Inst. of Applied Physics, Russian Academy of Sciences, Nizhny Novgorod, 2006, **Vol. 1**, 62-75.
- [541] Agapova, M.V., Bogdashov, A.A., Chirkov, A.V., Denisov, G.G., Gnedenko, A.Ph., Ilyin, V.I., Ilyin, V.N., Khmara, D.V., Kostyna, A.N., Kuftin, A.N., Kurbatov, V.I., Litvak, A.G., Lygin, V.K., Malygin, V.I., Malygin, S.A., Moiseev, M.A., Myasnikov, V.E., Nichiporenko, V.O., Popov, L.G., Soluyanov, E.A., Shamanova, N.A., Tai, E.M., Usachev, S.V., Zapevalov, V.E., 2005, Development status of 1 MW and 1.5-1.7 MW / 170 GHz gyrotrons for ITER. *Proc. 6th Int. Workshop on Strong Microwaves in Plasmas*, Nizhny Novgorod, ed. A.G. Litvak, Inst. of Applied Physics, Russian Academy of Sciences, Nizhny Novgorod, 2006, **Vol. 1**, 107-112.

- [542] Agapova, M.V., Denisov, G.G., Ilyin, V.I., Litvak, A.G., Myasnikov, V.E., Popov, L.G., Usachev, S.V., Zapevalov, V.E., Tai, E.M., 2006, Recent results in the development of 170 GHz/CW gyrotrons for ITER. Conf. Digest 31st Int. Conf. on Infrared and Millimeter Waves and 14th Int. Conf. on Terahertz Electronics, Shanghai, China, 516.
- [543] Denisov, G.G., Litvak, A.G., Myasnikov, V.E., Tai, E.M., Zapevalov, V.E., 2007, Recent results of development in Russia of high power gyrotrons, Proc. 8th IEEE Int. Vacuum Electronics Conference (IVEC 2007), Kitakyushu, Japan, 43-44.
- [544] Litvak, A.G., Denisov, G.G., Il'in, V.N., Myasnikov, V.E., Tai, E.M., Vikharev, A.L., Zapevalov, V.E., 2007, Recent results of development in Russia of high power gyrotrons. Conf. Digest 32nd Int. Conf. on Infrared and Millimeter Waves and 15th Int. Conf. on Terahertz Electronics, Cardiff, UK, 41-43.
- [545] Usachev, S.V., Agapova, M.V., Bogdashov, A.A., Chirkov, A.V., Denisov, G.G., Gnedenkov, A.Ph., Ilyin, V.N., Kostyna, A.N., Kuftin, A.N., Litvak, A.G., Malygin, V.I., Myasnikov, V.E., Nichiporenko, V.O., Popov, L.G., Soluyanov, E.A., Tai, E.M., Zapevalov, V.E., 2007, New test results of 170 GHz/1 MW/50%/CW gyrotron for ITER. Conf. Digest 32nd Int. Conf. on Infrared and Millimeter Waves and 15th Int. Conf. on Terahertz Electronics, Cardiff, UK, 44-45.
- [546] Popov, L.G., Denisov, G.G., Litvak, A.G., Agapova, M. V., Gnedenkov, A.Ph., Kostyna, A.N., Nichiporenko, V.O., Myasnikov, V.E., Tai, E.M., Usachev, S.V., Zapevalov, V.E., Chirkov, A.V., Ilin, V.I., Ilin, V.N., Kuftin, A.N., Malygin, S.A., Malygin, V.I., Parshin, V.V., Pavel'ev, A.B., Rukavishnikova, V.G., Roschin, Yu.V., Sokolov, E.V., Solyanova, E.A., Vikharev, A.L., 2008, Development in Russia of 170 GHz gyrotron for ITER, Proc. 33rd Int. Conf. on Infrared, Millimeter and Terahertz Waves, Pasadena, CA, USA, W4U4.1472.
- [547] Popov, L.G., Usachev, S.V., Agapova, M.V., Chirkov, A.V., Denisov, G.G., Gnedenkov, A.Ph., Ilyin, V.I., Ilyin, V.N., Kostyna, A.N., Kuftin, A.N., Litvak, A.G., Malygin, S.A., Malygin, V.I., Myasnikov, V.E., Nichiporenko, V.O., Roschin, Yu.V., Rukavishnikova, V.G., Soluyanov, E.A., Tai, E.M., Yakunin, A.N., Yashnov, Yu.M., Zapevalov, V.E., 2008, Test results of 170 GHz / 1 MW / 50% gyrotron for ITER, Proc. 7th Int. Workshop on Strong Microwaves: Sources and Applications, Nizhny Novgorod, ed. A.G. Litvak, Inst. of Applied Physics, Russian Academy of Sciences, Nizhny Novgorod, 2009, **Vol. 1**, pp. 95-99.
- [548] Litvak, A.G., Denisov, G.G., Agapova, M.V., Gnedenkov, A.Ph., Kostyna, A.N., Nichiporenko, V.O., Myasnikov, V.E., Popov, L.G., Tai, E.M., Usachev, S.V., Zapevalov, V.E., Chirkov, A.V., Ilin, V.I., Ilin, V.N., Kuftin, A.N., Malygin, S.A., Malygin, V.I., Parshin, V.V., Pavel'ev, A.B., Rukavishnikova, V.G., Roschin, Yu.V., Sokolov, E.V., Soluyanov, E.A., Vikharev, A.L., 2009, Development in Russia of 170 GHz gyrotron for ITER, Proc. 10th IEEE Int. Vacuum Electronics Conference (IVEC 2009), Rome, Italy, pp. 281-282.
- [549] Litvak, A.G., Denisov, G.G., Agapova, M.V., Gnedenkov, A.Ph., Kostyna, A.N., Nichiporenko, V.O., Myasnikov, V.E., Popov, L.G., Tai, E.M., Usachev, S.V., Zapevalov, V.E., Chirkov, A.V., Ilin, V.I., Ilin, V.N., Kuftin, A.N., Malygin, S.A., Malygin, V.I., Parshin, V.V., Zavolsky, N.A., Pavel'ev, A.B., Rukavishnikova, V.G., Roschin, Yu.V., Sokolov, E.V., Soluyanov, E.A., Usov, V.G., Vikharev, A.L., 2009, Development in Russia of 170 GHz gyrotron for ITER, Proc. 34th Int. Conf. on Infrared, Millimeter and Terahertz Waves, Busan, Korea, R4D02.0065.
- [550] Litvak, A.G., Denisov, G.G., Agapova, M.V., Myasnikov, V.E., Popov, L.G., Tai, E.M., Usachev, S.V., Zapevalov, V.E., Chirkov, A.V., Ilin, V.I., Kuftin, A.N., Malygin, V.I., Sokolov, E.V., Soluyanov, E.A., 2010, Recent results of development in Russia of 170 GHz gyrotron for ITER, Proc. 35th Int. Conf. on Infrared, Millimeter and Terahertz Waves, Rome, Italy, Tu-E1.1.

- [551] Usachev, S.V., Popov, L.G., Ilin, V.I., Agapova, M.V., Denisov, G.G., Gnednikov, A.Ph., Ilin, V.N., Khvostenko, A.P., Kostyna, A.N., Kuftin, A.N., Litvak, A.G., Malygin, V.I., Myasnikov, V.E., Nichiporenko, V.O., Novikov, V.N., Rukavishnikova, V.G., Sokolov, E.V., Soluyanov, E.A., Tai, E.M., Usov, V.G., Yashnon, Yu.M., Zapevalov, V.E., 2011, Last test results of 170 GHz / 1 MW / 50% / CW gyrotron for ITER, Proc. 8th Int. Workshop Strong Microwaves and Terahertz Waves: Sources and Applications, Nizhny Novgorod – St. Petersburg, Russia, July 9-16, 2011, pp. 136-137.
- [552] Litvak, A., Denisov, G., Agapova, M.V., Myasnikov, V., Popov, L., Tai, E.M., Usachev, S.V., Zapevalov, V.E., Chirkov, A., Ilin, V.I., Kuftin, A.N., Malygin, V.I., Sokolov, E.V., Solyanova, E., 2011, Development in Russia of 170 GHz gyrotron for ITER, Proc. 36th Int. Conf. on Infrared, Millimeter and Terahertz Waves (IRMMW-THz 2011), Houston, TX, USA, Th2A.1.
- [553] Sakamoto, K., Kasugai, A., Tsuneoka, M., Takahashi, K., Imai, T., Kariya, T., Okazaki, Y., Hayashi, K., Mitsunaka, Y., Hirata, Y., 1995, Development of 170 GHz gyrotron for ITER. Conf. Digest 20th Int. Conf. on Infrared and Millimeter Waves, Lake Buena Vista (Orlando), Florida, 269-270.
- [554] Sakamoto, K., Kasugai, A., Tsuneoka, M., Takahashi, K., Imai, T., Kariya, T., Okazaki, Y., Hayashi, K., Mitsunaka, Y., Hirata, Y., 1996, Development of 170 GHz high power long pulse gyrotron for ITER. Proc. 21st Int. Conf. on Infrared and Millimeter Waves, Berlin, AT1.
- [555] Sakamoto, K., Kasugai, A., Takahashi, K., Tsuneoka, M., Imai, T., Kariya, T., Hayashi, K., 1996, Stable, single-mode oscillation with high-order volume mode at 1 MW, 170 GHz gyrotron. J. of Physical Society of Japan, **65**, 1888-1890.
- [556] Sakamoto, K., Kasugai, A., Tsuneoka, M., Takahashi, K., Ikeda, Yu., Imai, T., Nagashima, T., Ohta, M., T., Kariya, T., Hayashi, K., Mitsunaka, Y., Hirata, Y., Ito, Y., Okazaki, Y., 1997, Development of 170 GHz/500 kW gyrotrons. Int. J. of Infrared and Millimeter Waves, **18**, 1637-1654.
- [557] Tsuneoka, M., Fujita, H., Sakamoto, K., Kasugai, A., Imai, T., Nagashima, T., Asaka, T., Kamioka, N., Yasuda, M., Iiyama, T., Yoshida, T., Nara, H., Ishibashi, M., 1997, Development of d.c. power supply for gyrotron with energy recovery system. Fusion Eng. and Design, **36**, 461-469.
- [558] Sakamoto, K., Kasugai, A., Tsuneoka, M., Takahashi, K., Imai, T., 1999, High power 170 GHz gyrotron with synthetic diamond window. Rev. Sci. Instrum., **70**, 208-212.
- [559] Sakamoto, K., Hayashi, K., Shoyama, H., Kasugai, A., Takahashi, K., Tsuneoka, M., Ikeda, Y., Kariya, T., Mitsunaka, T., Imai, T., 2001, Development of 170 GHz long pulse gyrotron for ITER. Conf. Digest, 26th Int. Conf. on Infrared and Millimeter Waves, Toulouse, France, 5-59-5-63.
- [560] Shoyama, H., Sakamoto, K., Hayashi, K., Kasugai, A., Tsuneoka, M., Tokahashi, K., Ideda, Y., Kariya, T., Mitsunaka, Y., Imai, T., 2002, High-efficiency oscillation of 170 GHz high-power gyrotron at TE_{31,8} mode using depressed collector. Jpn. J. Appl. Phys., **40**, L906-L908.
- [561] Kasugai, A., Sakamoto, K., Minami, R., Takahashi, K., Imai, T., 2004, Study of millimeter wave high-power. Nucl. Instruments & Methods in Physics Research, **A528**, 110-114.
Sakamoto, K., Kasugai, A., Minami, R., Takahashi, K., Kobayashi, N., Imai, T., 2004, Development of high power 170 GHz gyrotron for ITER. Conf. Digest 29th Int. Conf. on Infrared and Millimeter Waves and 12th Int. Conf. on Terahertz Electronics, Karlsruhe, Germany, 109-110.
- [562] Sakamoto, K., Kasugai, A., Minami, R., Takahashi, K., Kobayashi, N., 2005, Development of long pulse and high power 170 GHz gyrotron. Journal of Physics: Conference Series, **25**, 8-12.

- [563] Kasugai, A., Minami, R., Takahashi, M., Kobayashi, N., Sakamoto, K., 2005, Development of a 170 GHz high-power and CW gyrotron for fusion application. Conf. Digest 30th Int. Conf. on Infrared and Millimeter Waves and 13th Int. Conf. on Terahertz Electronics, Williamsburg, VA, USA, 287-288.
- [564] Minami, R., Kasugai, A., Takahashi, K., Kobayashi, N., Sakamoto, K., 2005, Development of high power gyrotron for ITER. Proc. 6th Int. Workshop on Strong Microwaves in Plasmas, Nizhny Novgorod, ed. A.G. Litvak, Inst. of Applied Physics, Russian Academy of Sciences, Nizhny Novgorod, 2006, **Vol. 1**, 100-106.
- [565] Kasugai, A., Takahashi, K., Kobayashi, N., Sakamoto, K., 2006, Development of 170 GHz gyrotron for ITER. Conf. Digest 31st Int. Conf. on Infrared and Millimeter Waves and 14th Int. Conf. on Terahertz Electronics, Shanghai, China, 202.
- [566] Sakamoto, K., Kasugai, A., Takahashi, K., Minami, R., Kobayashi, N., Kajiwara, K., 2007, Achievement of robust high-efficiency 1 MW oscillation in the hard-self-excitation region by a 170 GHz continuous-wave gyrotron. Nature Physics, **3**, 411-414.
- [567] Shoyama, H., Sakamoto, K., Hayashi, K., Kasugai, A., Tsuneoka, M., Takahashi, K., Ikeda, Y., Kariya, T., Mitsunaka, Y., Imai, T., 2001, High-efficiency oscillation of 170 GHz high-power gyrotron at TE_{31,8} mode using depressed collector. Jpn. J. Appl. Phys., **40**, L 906 – L 908.
- [568] Kasugai, A., Kajiwara, K., Takahashi, K., Kobayashi, N., Kariya, T., Mitsunaka, Y., Sakamoto, K., 2007, Steady state operation of high power gyrotron for ITER, Proc. 8th IEEE Int. Vacuum Electronics Conference (IVEC 2007), Kitakyushu, Japan, 37-40.
- [569] Sakamoto, K., 2007, Gyrotrons and mm wave technology for ITER. Conf. Digest 32nd Int. Conf. on Infrared and Millimeter Waves and 15th Int. Conf. on Terahertz Electronics, Cardiff, UK, 4-7.
- [570] Sakamoto, K., Kasugai, A., Kajiwara, K., Takahashi, K., Kobayashi, N., 2007, Demonstration of high efficiency 1 MW oscillation by 170 GHz CW gyrotron. Conf. Digest 32nd Int. Conf. on Infrared and Millimeter Waves and 15th Int. Conf. on Terahertz Electronics, Cardiff, UK, 708-709.
- [571] Sakamoto, K., Kajiwara, K., Kasugai, A., Oda, Y., Kobayashi, T., Takahashi, K., Kobayashi, N., Moriyama, S., Fujii, T., 2008, High power gyrotron development for fusion application, Proc. 33rd Int. Conf. on Infrared, Millimeter and Terahertz Waves, Pasadena, CA, USA, R4A1.1695.
- [572] Kasugai, A., Sakamoto, K., Takahashi, K., Kajiwara, K., Kobayashi, N., 2008, Steady-state operation of 170 GHz-1 MW gyrotron for ITER. Nucl. Fusion, **48**, 054009 (6pp).
- [573] Sakamoto, K., Kajiwara, K., Kasugai, A., Takahashi, K., Kobayashi, N., Oda, Y., 2008, High power 170 GHz gyrotron development in JAEA, Proc. 7th Int. Workshop on Strong Microwaves: Sources and Applications, Nizhny Novgorod, ed. A.G. Litvak, Inst. of Applied Physics, Russian Academy of Sciences, Nizhny Novgorod, 2009, **Vol. 1**, 7-14.
- [574] Sakamoto, K., Kasugai, A., Kajiwara, K., Oda, Y., Takahashi, K., Hayashi, K., Ideda, Y., Okazaki, Y., Kobayashi, N., 2009, Progress of high power gyrotron development in JAEA, Proc. 34th Int. Conf. on Infrared, Millimeter and Terahertz Waves, Busan, Korea, R4D01.0427.
- [575] Sakamoto, K., Kasugai, A., Kajiwara, K., Takahashi, K., Oda, Y., Hayashi, K., Kobayashi, N., 2009, Progress of high power 170 GHz gyrotron in JAEA, Nucl. Fusion, **49**, 095019 (6pp).
- [576] Kajiwara, K., Kasugai, A., Oda, Y., Takahashi, K., Kobayashi, N., Sakamoto, K., 2009, Long pulse and high power repetitive operation of the 170 GHz ITER gyrotron, Plasma and Fusion Research: Letters, **4**, 006-1 – 006-3.
- [577] Kajiwara, K., Oda, Y., Kasugai, A., Takahashi, K., Sakamoto, K., 2010, Reliability test of the ITER 170 GHz gyrotron and development of the two-frequency gyrotron, Proc. 11th IEEE Int. Vacuum Electronics Conference (IVEC 2010), Monterey, USA, pp. 31-32.

- [578] Sakamoto, K., Kajiwara, K., Takahashi, K., Oda, Y., Kasugai, A., Kobayashi, T., Kobayashi, N., Henderson, M., Darbos, C., 2010, Development of high power gyrotron for ITER application, Proc. 35th Int. Conf. on Infrared, Millimeter and Terahertz Waves, Rome, Italy, Tu-E1.6.
- [579] Kajiwara, K., Kasugai, A., Oda, Y., Takahashi, K., Sakamoto, K., Darbos, C., Henderson, M., 2011, Reliability test of the 170 GHz gyrotron for ITER, J. of Infrared Milli Terahz Waves, **32**, 329-336.
- [580] Kajiwara, K., Oda, Y., Kasugai, A., Takahashi, K., Sakamoto, K., Darbos, C., Henderson, M.A., 2011, Repetitive gyrotron operation for ITER. Fusion Engineering and Design, **86**, 955-958.
Kajiwara, K., Oda, Y., Kasugai, A., Takahashi, K., Sakamoto, K., 2012, Progress of the development of gyrotron and gyrotron system for ITER, Proc. 13th IEEE Int. Vacuum Electronics Conference and 9th IEEE Int. Vacuum Electron Sources Conference (IVEC-IVESC 2012), Monterey, CA, USA, pp. 107-108.
- [581] Hayashi, K., Mitsunaka, Y., Hirata, Y., Kariya, T., Okazaki, Y., Yamazaki, C., Saito, F., 2001, Design and tests of 168-GHz, 500-kW gyrotrons and power supply system. Fusion Engineering and Design, **53**, 457-464.
- [582] Shimozuma, T., Kubo, S., Yoshimura, Y., Igami, H., Takahashi, H., Kobayashi, S., Ito, S., Mizumo, Y., Okada, K., Takita, Y., Mutoh, T., Idei, H., Minami, R., Kariya, T., Imai, T., 2010, Progress of a multi-megawatt gyrotron system for electron cyclotron heating on the large helical device, Proc. 35th Int. Conf. on Infrared, Millimeter and Terahertz Waves, Rome, Italy, Tu-P.04.
- [583] Flyagin, V.A., Khishnyak, V.I., Manuilov, V.N., Pavelyev, A.B., Pavelyev, V.G. Piosczyk, B., Dammertz, G., Höchtl, O., Iatrou, C., Kern, S., Nickel, H.-U., Thumm, M., Wien, A., Dumbrajs, O., 1994, Development of a 1.5 MW coaxial gyrotron at 140 GHz. Conf. Digest 19th Int. Conf. on Infrared and Millimeter Waves, Sendai, JSAP Catalog No.: **AP 941228**, 75-76.
- [584] Piosczyk, B., Braz, O., Dammertz, G., Iatrou, C.T., Kern, S., Möbius, A., Thumm, M., Wien, A., Zhang, S.C., Flyagin, V.A., Khishnyak, V.I., Kuftin, A.N., Manuilov, V.N., Pavelyev, A.B., Pavelyev, V.G., Postnikova, A.N., Zapevalov, V.E., 1995, Development of a 1.5 MW, 140 GHz coaxial gyrotron. Conf. Digest 20th Int. Conf. on Infrared and Millimeter Waves, Lake Buena Vista (Orlando), Florida, 423-424.
- [585] Piosczyk, B., Braz, O., Dammertz, G., Iatrou, C.T., Kern, S., Kuntze, M., Möbius, A., Thumm, M., Flyagin, V.A., Khishnyak, V.I., Kuftin, A.N., Malygin, V.I., Pavelyev, A.B., Zapevalov, V.E., 1996, A 140 GHz, 1.5 MW, TE_{28,16}-coaxial cavity gyrotron. Proc. 21st Int. Conf. on Infrared and Millimeter Waves, Berlin, AM2.
- [586] Iatrou, C.T., Braz, O., Dammertz, G., Kern, S., Kuntze, M., Piosczyk, B., Thumm, M., 1996, Operation of a megawatt coaxial gyrotron at 165 GHz. Proc. 21st Int. Conf. on Infrared and Millimeter Waves, Berlin, ATh15.
- [587] Thumm, M., Braz, O., Dammertz, G., Iatrou, C.T., Kern, S., Kuntze, M., Möbius, A., Piosczyk, B., Flyagin, V.A., Khishnyak, V.I., Malygin, V.I., Pavelyev, A.B., Zapevalov, V.E., 1996, Experimental results of 1.5 MW coaxial cavity gyrotrons in the frequency range 115-170 GHz. Proc. 3rd Int. Workshop on Strong Microwaves in Plasmas, Nizhny Novgorod, 1997, **Vol.2**, 614-633.
- [588] Piosczyk, B., Braz, O., Dammertz, G., Iatrou, C.T., Kern, S., Kuntze, M., Michel, G., Möbius, A., Thumm, M., Flyagin, V.A., Khishnyak, V.I., Pavelyev, A.B., Zapevalov, V.E., 1997, Operation of a coaxial gyrotron with a dual RF-beam output. Conf. Digest 22nd Int. Conf. on Infrared and Millimeter Waves, Wintergreen, Virginia, USA, 114-115.
- [589] Piosczyk, B., Braz, O., Dammertz, G., Iatrou, C.T., Kern, S., Kuntze, M., Möbius, A., Thumm, M., Flyagin, V.A., Khishnyak, V.I., Malygin, V.I., Pavelyev, A.B., Zapevalov, V.E., 1997, A 1.5-MW, 140-GHz, TE_{28,16}-coaxial cavity gyrotron. IEEE Trans. on Plasma Science, **PS-25**, 460-469.

- [590] Iatrou, C.T., Braz, O., Dammertz, G., Kern, S., Kuntze, M., Piosczyk, B., M. Thumm, 1997, Design and experimental operation of a 165-GHz, 1.5-MW, coaxial-cavity gyrotron with axial rf output. *IEEE Trans. on Plasma Sciences*, **PS-25**, 470-479.
- [591] Piosczyk, B., Braz, O., Dammertz, G., Iatrou, C.T., Illy, S., Kuntze, M., Michel, G., Möbius, A., Thumm, M., Flyagin, V.A., Khishnyak, V.I., Pavelyev, A.B., Zapevalov, V.E., 1998, Coaxial cavity gyrotron with dual RF beam output. *IEEE Trans. on Plasma Science*, **PS-26**, 393-401.
- [592] Piosczyk, B., Braz, O., Dammertz, G., Iatrou, C.T., Kuntze, M., Michel, G., Möbius, A., Thumm, M., 1998, 165 GHz, TE_{31,17} - coaxial cavity gyrotron with quasi-optical RF-output. *Conf. Digest 23rd Int. Conf. on Infrared and Millimeter Waves*, Colchester, UK, 168-169.
- [593] Piosczyk, B., Braz, O., Dammertz, G., Iatrou, C.T., Illy, S., Kuntze, M., Michel, G., Thumm, M., 1999, 165 GHz, 1.5 MW-Coaxial cavity gyrotron with depressed collector. *IEEE Trans. on Plasma Science*, **PS-27**, 484-489.
- [594] Dumbrajs, O., Khizhnyak, V.I., Pavelyev, A.B., Piosczyk, B., Thumm, M., 1999, Design of rapid frequency-step-tunable powerful coaxial-cavity harmonic gyrotrons. *Conf. Digest 24th Int. Conf. on Infrared and Millimeter Waves*, Monterey, California, USA, TU-A6.
Dumbrajs, O., Anderer, J., Illy, S., Piosczyk, B., Thumm, M., Zavolsky, N.A., 1999, Multifrequency operation of a gyrotron. *IEEE Trans. on Plasma Science*, **PS-27**, 327-329.
Dumbrajs, O., Gandel, Y.V., Zaginaylov, G.I., 2002, Full wave analysis of coaxial gyrotron cavity with corrugated insert. *Proc. 27th Int. Conf. on Infrared and Millimeter Waves*, San Diego, USA, 185-186.
- [595] Piosczyk, B., Braz, O., Dammertz, G., Kuntze, M., Michel, G., Lamba, O.S., Thumm, M., 1999, Progress report on the 165 GHz coaxial cavity gyrotron. *Conf. Digest 24th Int. Conf. on Infrared and Millimeter Waves*, Monterey, California, USA, TU-A9.
- [596] Michel, G., Kuntze, M., Piosczyk, B., Thumm, M., 1999, Considerations on multimode quasi-optical converters. *Conf. Digest 24th Int. Conf. on Infrared and Millimeter Waves*, Monterey, California, USA, PS-8.
- [597] Piosczyk, B., Braz, O., Dammertz, G., Kuntze, M., Michel, G., Thumm, M., 1999, Status of the 1.5 MW, 165 GHz coaxial cavity gyrotron. *Proc. 4th Int. Workshop on Strong Microwaves in Plasmas*, Nizhny Novgorod, ed. A.G. Litvak, Inst. of Applied Physics, Russian Academy of Sciences, Nizhny Novgorod, 2000, **Vol. 2**, 629-634.
- [598] Piosczyk, B., Arnold, A., Dammertz, G., Dumbrajs, O., Kuntze, M., Leonhardt, W., Pavelyev, A.B., Schmid, M., Thumm, M., 2000, 2.2 MW, 165 GHz coaxial cavity gyrotron. *Conf. Digest 25th Int. Conf. on Infrared and Millimeter Waves*, Beijing, P.R. China, 19-20.
- [599] Piosczyk, B., Arnold, A., Dammertz, G., Kuntze, M., Michel, G., Lamba, O.S., Thumm, M.K., 2000, Step-frequency operation of a coaxial cavity from 134 to 169.5 GHz. *IEEE Trans. on Plasma Science*, **PS-28**, 918-923.
- [600] Dumbrajs, O., Khizhnyak, V.I., Pavelyev, A.B., Piosczyk, B., Thumm, M.K., 2000, Design of rapid-frequency step-tunable powerful coaxial-cavity harmonic gyrotrons. *IEEE Trans. on Plasma Science*, **PS-28**, 681-687.
- [601] Piosczyk, B., Arnold, A., Dammertz, G., Dumbrajs, O., Kuntze, M., Thumm, M.K., 2002, Coaxial cavity gyrotron-recent experimental results. *IEEE Trans. on Plasma Science*, **PS-30**, 819-827.
- [602] Ling, G., Piosczyk, B., Thumm, M.K., 2000, A new approach for a multistage depressed collector for gyrotrons. *IEEE Trans. on Plasma Science*, **PS-28**, 606-613.
- [603] Piosczyk, B., Arnold, A., Budig, H., Dammertz, G., Dumbrajs, O., Drumm, O., Kartikeyan, M.V., Kuntze, M., Thumm, M., Yang, X., 2002, A 2 MW, CW coaxial cavity gyrotron. Experimental and technical conditions. *Proc. 5th Int. Workshop on Strong Microwaves in Plasmas*, Nizhny Novgorod, ed. A.G. Litvak, Inst. of Applied Physics, Russian Academy of Sciences, Nizhny Novgorod, 2003, **Vol. 1**, 104-110.

- [604] Piosczyk, B., Budig, H., Dammertz, G., Dumbrajs, O., Drumm, O., Illy, S., Jin, J., Thumm, M., 2003, Coaxial cavity gyrotron – recent results and ongoing development work. Conf. Digest 28th Int. Conf. on Infrared and Millimeter Waves, Otsu, Japan, 167-168.
- [605] Piosczyk, B., Dammertz, G., Dumbrajs, O., Kartikeyan, M.V., Thumm, M.K., Yang, X., 2004, 165-GHz coaxial cavity gyrotron. *IEEE Trans. on Plasma Science*, **PS-32**, 853-860.
- [606] Piosczyk, B., Arnold, A., Budig, H., Dammertz, G., Dumbrajs, O., Drumm, O., Kartikeyan, M.V., Kuntze, M., Thumm, M., Yang, X., 2003, Towards a 2 MW, CW, 170 GHz coaxial cavity gyrotron for ITER. *Fusion Engineering and Design*, **66-68**, 481-485.
- [607] Piosczyk, B., Arnold, A., Budig, H., Dammertz, G., Dumbrajs, O., Illy, S., Jin, J., Michel, G., Rzesnicki, T., Thumm, M., Wagner, D., 2004, 2 MW, CW, 170 GHz coaxial cavity gyrotron. Proc. 10th Int. Conf. Displays and Vacuum Electronics, Garmisch-Partenkirchen, ITG-Fachbericht **183**, 45-49, Invited Paper.
- [608] Piosczyk, B., Arnold, A., Borie, E., Dammertz, G., Dumbrajs, O., Heidinger, R., Illy, S., Jin, J., Koppenburg, K., Michel, G., Rzesnicki, T., Thumm, M., Yang, X., 2004, Development of advanced high power gyrotrons for EC H&CD applications in fusion plasmas. Proc. 13th Joint Workshop on Electron Cyclotron Emission and Electron Cyclotron Heating (EC13), ed. A. Litvak, Inst. of Applied Physics, Russian Academy of Sciences, Nizhny Novgorod, 2005, 377-382.
- [609] Piosczyk, B., Rzesnicki, T., Arnold, A., Budig, H., Dammertz, G., Dumbrajs, O., Illy, S., Jin, J., Koppenburg, K., Leonhardt, W., Michel, G., Schmid, M., Thumm, M., Yang, X., 2004, Progress in the development of the 170 GHz coaxial cavity gyrotron. Conf. Digest 29th Int. Conf. on Infrared and Millimeter Waves and 12th Int. Conf. on Terahertz Electronics, Karlsruhe, Germany, 107-108.
- [610] Piosczyk, B., Dammertz, G., Dumbrajs, O., Drumm, O., Illy, S., Jin, J., Thumm, M., 2004, A 2-MW, 170-GHz coaxial cavity gyrotron. *IEEE Trans. on Plasma Science*, **PS-32**, 413-417.
- [611] Piosczyk, B., Dammertz, G., Dumbrajs, O., Illy, S., Jin, J., Leonhardt, W., Michel, G., Prinz, O., Rzesnicki, T., Schmid, M., Thumm, M., Yang, X., 2005, A 2 MW, 170 GHz coaxial cavity gyrotron – experimental verification of the design of main components. *Journal of Physics: Conference Series*, **25**, 24-32.
- [612] Hogge, J.-P., Alberti, S., Arnold, A., Bariou, D., Beunas, A., Bonicelli, T., Chavan, R., Cirani, S., Dumbrajs, O., Drumm, O., Fasel, D., Giguet, E., Goodman, T., Henderson, M., Illy, S., Jin, J., LeCloarec, G., Lievin, C., Magne, R., Mondino, P.-L., Piosczyk, B., Porte, L., Rzesnicki, T., Santinelli, M., Sterck, A.B., Thumm, M., Tran, M.Q., Verhoeven, A.G.A., Yovchev, I., 2004, Development of a 2 MW, CW, 170 GHz coaxial cavity gyrotron for ITER. Proc. 13th Joint Workshop on Electron Cyclotron Emission and Electron Cyclotron Heating (EC13), ed. A. Litvak, Inst. of Applied Physics, Russian Academy of Sciences, Nizhny Novgorod, 2005, 393-397.
- [613] Hogge, J.-P., Alberti, S., Arnold, A., Bariou, D., Benin, P., Bonicelli, T., Bruschi, A., Chavan, R., Cirant, S., Dumbrajs, O., Fasel, D., Gandini, F., Giguet, E., Goodman, T., Heidinger, R., Henderson, M., Illy, S., Jin, J., Lievin, C., Magne, R., Marmillod, P., Mondino, P.-L., Perez, A., Piosczyk, B., Porte, L., Rzesnicki, T., Santinelli, M., Thumm, M., Tran, M.Q., Yovchev, I., 2005, Development of a 2-MW, CW coaxial gyrotron at 170 GHz and test facility for ITER. *Journal of Physics: Conference Series*, **25**, 33-44.
- [614] Lievin, C., Alberti, S., Arnold, A., Bariou, D., Benin, P., Bonicelli, T., Dammertz, G., Dumbrajs, O., Fasel, D., Giguet, E., Goodman, T., Heidinger, R., Henderson, M., Hogge, J.P., Illy, S., Jin, J., Mondino, P.L., Piosczyk, B., Porte, L., Rzesnicki, T., Thumm, M., Tran, M.Q., Yovchev, I., 2005, Development of a 2-MW, CW coaxial gyrotron at 170 GHz for electron-cyclotron-resonance-heating in ITER. Proc. 6th IEEE Int. Vacuum Electronics Conf. (IVEC 2005), Noordwijk, The Netherlands, 21-24.

- [615] Piosczyk, B., Rzesnicki, T., Dammertz, G., Dumbrajs, O., Illy, S., Jin, J., Leonhardt, W., Michel, G., Schmid, M., Thumm, M., Yang, X., 2005, 170 GHz, 2 MW, CW coaxial cavity gyrotron – experimental verification of the design – . Conf. Digest 30th Int. Conf. on Infrared and Millimeter Waves and 13th Int. Conf. on Terahertz Electronics, Williamsburg, VA, USA, 289-290.
- [616] Piosczyk, B., Alberti, S., Bariou, D., Benin, P., Bonicelli, T., Dammertz, G., Dumbrajs, O., Fasel, D., Giguet, E., Goodman, T., Heidinger, R., Henderson, M., Hogge, J.P., Illy, S., Jin, J., Lievin, C., Michel, G., Mondino, P.L., Porte, L., Rzesnicki, T., Thumm, M., Tran, M.Q., Yang, X., Yovchev, I., 2005, Progress in the development of the 170 GHz coaxial cavity gyrotron for ITER. Proc. 6th Int. Workshop on Strong Microwaves in Plasmas, Nizhny Novgorod, ed. A.G. Litvak, Inst. of Applied Physics, Russian Academy of Sciences, Nizhny Novgorod, 2006, **Vol. 1**, 91-99.
- [617] Piosczyk, B., Alberti, S., Benin, P., Bonicelli, T., Dammertz, G., Dumbrajs, O., Gantenbein, G., Giguet, E., Goodman, T., Hogge, J.P., Illy, S., Lievin, C., Michel, G., Porte, L., Rzesnicki, T., Schmid, M., Thumm, M., Tran, M.Q., 2006, Progress in development of the 170 GHz, 2 MW coaxial cavity gyrotron for ITER. Conf. Digest 31st Int. Conf. on Infrared and Millimeter Waves and 14th Int. Conf. on Terahertz Electronics, Shanghai, China, 197.
- [618] Bonicelli, T., S. Alberti, S. Cirant, O. Dormicchi, D. Fasel, J.P. Hogge, S. Illy, J. Jin, C. Lievin, P.L. Mondino, B. Piosczyk, T. Rzesnicki, M. Santinelli, G. Taddia, M. Thumm, M.Q. Tran, 2007, EC power sources: European technological developments towards ITER, *Fusion Engineering and Design*, **82**, 619-626.
- [619] Rzesnicki, T., Piosczyk, B., Dammertz, G., Gantenbein, G., Thumm, M., Michel, G., 2007, 170 GHz, 2 MW coaxial cavity gyrotron – investigation of the parasitic oscillations and efficiency of the RF-output system -, Proc 8th IEEE International Vacuum Electronics Conference (IVEC 2007), Kitakyushu, Japan, 45-46.
- [620] Rzesnicki, T., Piosczyk, B., Flamm, J., Jin, J., Kern, S., Prinz, O., Thumm, M., 2008, 170 GHz, 2 MW coaxial cavity gyrotron - experimental investigations on the pre-prototype tube -, Proc. 9th IEEE Int. Vacuum Electronics Conference (IVEC 2008), Monterey, CA, USA, 30-31.
- [621] Rzesnicki, T., Piosczyk, B., Flamm, J., Jin, J., Kern, S., Prinz, O., Thumm, M., 2008, Recent experimental results on the 170 GHz, 2 MW coaxial cavity pre-prototype gyrotron for ITER, Proc. 33rd Int. Conf. on Infrared, Millimeter and Terahertz Waves, Pasadena, CA, USA, W4U5.1521.
- [622] Alberti, S., Albajar, F., Avramides, K.A., Benin, P., Bin, W., Bonicelli, T., Bruschi, A., Cirant, S., Droz, E., Dumbrajs, O., Fasel, D., Gandini, F., Goodman, T., Hogge, J.-P., Illy, S., Jawla, S., Jin, J., Kern, S., Lievin, C., Marlétaz, B., Marmillod, Ph., Pagonakis, I., Perez, A., Piosczyk, B., Porte, L., Rzesnicki, T., Siravo, U., Thumm, M., Tran, M.Q., 2008, Status of development of the 2 MW, 170 GHz coaxial-cavity gyrotron for ITER, Proc. 33rd Int. Conf. on Infrared, Millimeter and Terahertz Waves, Pasadena, CA, USA, F2A1.1413.
- [623] Hogge, J.-P., Goodman, T.P., Alberti, S., Albajar, F., Avramides, K.A., Benin, P., Bethuys, S., Bin, W., Bonicelli, T., Bruschi, A., Cirant, S., Droz, E., Dumbrajs, O., Fasel, D., Gandini, F., Gantenbein, G., Illy, S., Jawla, S., Jin, J., Kern, S., Lavanchy, P., Liévin, C., Marlétaz, B., Marmillod, P., Perez, A., Piosczyk, B., Pagonakis, I., Porte, L., Rzesnicki, T., Siravo, U., Thumm, M., Tran, M.Q., 2009, First experimental results from the European Union 2-MW coaxial cavity ITER gyrotron prototype, *Fusion Science and Technology*, **55**, 204-212.
- [624] Rzesnicki, T., Piosczyk, B., Gantenbein, G., Jin, J., Kern, St., Samartsev, A., Thumm, M., 2009, 170 GHz, 2 MW coaxial cavity gyrotron for ITER – recent results obtained with a short pulse tube –, Proc. 10th IEEE Int. Vacuum Electronics Conference (IVEC 2009), Rome, Italy, pp. 277-278.

- [625] Rzesnicki, T., Piosczyk, B., Gantenbein, G., Jin, J., Kern, S., Samartsev, A., Thumm, M., 2009, Major progress in the development of the 2 MW coaxial-cavity gyrotron for ITER, Proc. 34th Int. Conf. on Infrared, Millimeter and Terahertz Waves, Busan, Korea, R4D04.0032.
- [626] Rzesnicki, T., Piosczyk, B., Kern, S., Illy, S., Jin, S., Samartsev, A., Schlaich, A., Thumm, M., 2010, 2.2-MW record power of the 170-GHz European preprototype coaxial-cavity gyrotron for ITER, IEEE Trans. on Plasma Science, **38**, 1141-1149.
- [627] Rzesnicki, T., Piosczyk, B., Kern, S., Illy, S., Jin, J., Samartsev, A., Schlaich, A., Thumm, M., 2010, Experiments with the European 2 MW coaxial-cavity pre-prototype gyrotron for ITER, Proc. 11th IEEE Int. Vacuum Electronics Conference (IVEC 2010), Monterey, USA, pp. 27-28.
- [628] Rzesnicki, T., Piosczyk, B., Roy Choudhury, A., Illy, S., Jin, J., Kern, S., Samartsev, A., Schlaich, A., Thumm, M., 2010, Recent results with the European 2 MW coaxial-cavity pre-prototype gyrotron for ITER, Proc. 35th Int. Conf. on Infrared, Millimeter and Terahertz Waves, Rome, Italy, Tu-E1.2.
- [629] Rzesnicki, T., Piosczyk, B., Illy, S., Jin, J., Kern, S., Pagonakis, I.Gr., Samartsev, A., Schlaich, A., Thumm, M., 2011, 2 MW, 170 GHz coaxial-cavity gyrotron for ITER: Results obtained with a short pulse pre-prototype at KIT, Proc. 8th Int. Workshop Strong Microwaves and Terahertz Waves: Sources and Applications, Nizhny Novgorod – St. Petersburg, Russia, July 9-16, 2011, pp. 121-122.
- [630] Rzesnicki, T., Piosczyk, B., Illy, S., Jin, J., Kern, S., Pagonakis, I., Samartsev, A., Schlaich, A., Thumm, M., 2011, Status of experiments with the 2 MW coaxial-cavity pre-prototype gyrotron for ITER, Proc. 36th Int. Conf. on Infrared, Millimeter and Terahertz Waves (IRMMW-THz 2011), Houston, TX, USA, Th2A.3.
- [631] Kern, S., Hogge, J.P., Alberti, S., Avramides, K., Gantenbein, G., Illy, S., Jelonnek, J., Jin, J., Li, F., Pagonakis, I.Gr., Piosczyk, B., Rzesnicki, T., Thumm, M.K., Tigelis, I., Tran, M.Q., and the whole EU home team of EGYC, 2012, Experimental results and recent developments on the EU 2 MW 170 GHz coaxial cavity gyrotron for ITER. EPJ Web of Conferences, **32**, 04009/1-6.
- [632] Rzesnicki, T., Piosczyk, B., Gantenbein, G., Illy, S., Jelonnek, J., Jin, J., Kern, S., Pagonakis, I.Gr., Samartsev, A., Schlaich, A., Thumm, M., 2012, 2 MW coaxial-cavity pre-prototype gyrotron for ITER – recent experiments with the modified gyrotron setup -, 38th Int. Conf. on Infrared, Millimeter and Terahertz Waves (IRMMW-THz 2012), Wollongong, Australia, Sept 23-28, 2012, Mon-A-3-3.
- [633] Vlasov, S.N., Zagryadskaya, L.I., Orlova, I.M., 1976, Open coaxial resonators for gyrotrons. Radio Eng. Electron. Phys., **21**, 96-102.
- [634] Gaponov, A.V., Flyagin, V.A., Goldenberg, A.L., Nusinovich, G.S., Tsimring, Sh.E., Usov, V.G., Vlasov, S.N., 1981, Powerful millimeter-wave gyrotrons. Int. J. Electronics, **51**, 277-302.
- [635] Flyagin, V.A., Khizhnyak, V.I., Kuftin, A.N., Manuilov, V.N., Pavelyev, A.B., Pavelyev, V.G., Zapevalov, V.E., 1997. Investigation of coaxial gyrotrons at IAP RAS. Conf. Digest 22nd Int. Conf. on Infrared and Millimeter Waves, Wintergreen, Virginia, USA, 112-113.
- [636] Pavelyev, A.B., Flyagin, V.A., Khizhnyak, V.I., Manuilov, V.N., Zapevalov, V.E., 1999, Investigations of advanced coaxial gyrotrons at IAP RAS. Proc. Int. University Conf. "Electronics and Radiophysics of Ultra-High Frequencies" (UHF-99), 1999, St. Petersburg, Russia, 142-145.
- [637] Khizhnyak, V.I., Manuilov, V.N., Pavelyev, A.B., Zapevalov, V.E., 2000, Investigations of advanced coaxial gyrotrons at IAP RAS, Conf. Digest 25th Int. Conf. on Infrared and Millimeter Waves, Beijing, P.R. China, 117-118.
- [638] Zapevalov, V.E., Pavelyev, A.B., Khizhnyak, V.I., 2000, Experimental test of the natural scheme of electron beam energy recovery in a coaxial gyrotron. Radiophysics and Quantum Electronics, **43**, 671-674.

- [639] Khizhnyak, V.I., Manuilov, V.N., Pavelyev, A.B., Zapevalov, V.E., 2001, Natural scheme of electron beam energy recovery in coaxial gyrotron. Proc. 9th Int. Conf. Displays and Vacuum Electronics, Garmisch-Partenkirchen, ITG-Fachbericht **165**, 153-157.
- [640] Zapevalov, V.E., Khizhnyak, V.I., Moiseev, M.A., Pavelyev, A.B., Zavolsky, N.A., 2002, Advantages of coaxial cavity gyrotrons. Proc. 5th Int. Workshop on Strong Microwaves in Plasmas, Nizhny Novgorod, ed. A.G. Litvak, Inst. of Applied Physics, Russian Academy of Sciences, Nizhny Novgorod, 2003, **Vol. 1**, 111-115.
- [641] Flyagin, V.A., Khizhnyak, V.I., Manuilov, V.N., Moiseev, M.A., Pavelyev, A.B., Zapevalov, V.E., Zavolsky, N.A., 2003, Investigations of advanced coaxial gyrotrons at IAP RAS. Int. J. of Infrared and Millimeter Waves, **24**, 1-17.
- [642] Hogge, J.P., Kreisler, K.E., Read, M.E., 1995, Results of testing a 3 MW, 140 GHz gyrotron with a coaxial cavity. Conf. Digest 20th Int. Conf. on Infrared and Millimeter Waves, Lake Buena Vista (Orlando), Florida, 417-418.
- [643] Kimura, T., Hogge, J.P., Advani, R., Denison, D., Kreisler, K.E., Temkin, R.J., 1996, Investigation of megawatt power level gyrotrons for ITER. Proc. 21st Int. Conf. on Infrared and Millimeter Waves, Berlin, AM1.
- [644] Advani, R., Hogge, J.P., Kreisler, K.E., Pedrozzi, M., Read, M.E., Sirigiri, J.R., Temkin, R.J., 2002, Experimental investigation of a 140 GHz coaxial gyrotron oscillator. IEEE Trans. on Plasma Science, **PS-29**, 943-950.
- [645] Beringer, M.H., Illy, S., Jin, J., Kern, S., Rode, J.C., Thumm, M., 2009, Further design steps towards a 4 MW 170 GHz coaxial-cavity gyrotron, Proc. 34th Int. Conf. on Infrared, Millimeter and Terahertz Waves, Busan, Korea, T4C04.0154.
- [646] Beringer, M.H., Illy, S., Jin, J., Kern, S., Lievin, C., Thumm, M., 2010, Design of major components for a 4 MW 170 GHz coaxial-cavity gyrotron, Proc. 11th IEEE Int. Vacuum Electronics Conference (IVEC 2010), Monterey, USA, pp. 35-36.
- [647] Hargreaves, T.A., Fliflet, A.W., Fischer, R.P., Barsanti, M.L., 1990, Depressed collector performance on the NRL quasi-optical gyrotron. Conf. Digest 15th Int. Conf on Infrared and Millimeter Waves, Orlando, Proc., SPIE **1514**, 330-332.
- [648] Nichiporenko, V., Popov, L., Myasnikov, V., Agapova, M., Belov, Yu., Gnedenkov, A., Ilyin, V., Irkhin, V., Kazansky, I., Kruglov, A., Rukavishnikova, V., Shamanova, N., Soluyanov, E., Tai, E., Usachev, S., Litvak, A., Chirkov, A., Denisov, G., Kuftin, A., Malygin, V., Zapevalov, V., Zohm, H., Stober, J., Wagner, D., Leuterer, F., Monaco, F., Munich, M., Schuetz, H., 2010, Multi-frequency gyrotron for ASDEX Upgrade, Proc. 35th Int. Conf. on Infrared, Millimeter and Terahertz Waves, Rome, Italy, Tu-P.05.
- [649] Anderson, J.P., Shapiro, M.A., Temkin, R.J., Mastovsky, I., 2003, Operation of a 1.5 MW, 110 GHz gyrotron experiment. Conf. Digest 28th Int. Conf. on Infrared and Millimeter Waves, Otsu, Japan, 171-172.
- [650] Anderson, J.P., Shapiro, M.A., Temkin, R.J., Mastovsky, I., 2004, Recent results for the 1.5-MW, 110-GHz gyrotron experiment. 5th IEEE Int. Vacuum Electronics Conf. (IVEC 2004), Monterey, CA, USA, 34-35.
Anderson, J.P., Shapiro, M.A., Temkin, R.J., Mastovsky, I., 2004, Operation of a 1.5-MW, 110-GHz gyrotron depressed collector experiment. Conf. Digest 29th Int. Conf. on Infrared and Millimeter Waves and 12th Int. Conf. on Terahertz Electronics, Karlsruhe, Germany, 155-156.
- [651] Choi, E.M., Marchewka, C., Mastovsky, I., Shapiro, M.A., Sirigiri, J.R., Temkin, R.J., 2005, Megawatt power level 120 GHz gyrotrons for ITER start-up. Journal of Physics: Conference Series, **25**, 1-7.
- [652] Anderson, J.P., Shapiro, M.A., Temkin, R.J., Mastovsky, I., Cauffman, S.R., 2004, Studies of the 1.5-MW 110 GHz gyrotron experiment. IEEE Trans. on Plasma Science, **PS-32**, 877-883.

- [653] Choi, E.M., Sirigiri, J.R., Shapiro, M.A., Temkin, R.J., 2005, Recent results from the 1.5 MW, 110 GHz gyrotron experiment at MIT. Proc. 6th IEEE Int. Vacuum Electronics Conf. (IVEC 2005), Noordwijk, The Netherlands, 115-116.
- [654] Choi, E.M., Marchewka, C., Sirigiri, J.R., Shapiro, M.A., Temkin, R.J., 2005, Experimental results for a 1.5 MW, 110 GHz gyrotron with an improved cavity. Conf. Digest 30th Int. Conf. on Infrared and Millimeter Waves and 13th Int. Conf. on Terahertz Electronics, Williamsburg, VA, USA, 241-242.
- [655] Choi, E.M., Cerfon, A.J., Mastovsky, I., Shapiro, M.A., Sirigiri, J.R., Temkin, R.J., 2007, Efficiency enhancement of a 1.5-MW, 110-GHz gyrotron with a single-stage depressed collector. *Fusion Science and Technology*, **52**, 334-339.
- [656] Choi, E., Cerfon, A.J., Mastovsky, I., Mulligan, W., Shapiro, M.A., Sirigiri, J.R., Temkin, R.J., 2007, Experimental study of a 1.5 MW, 110 GHz gyrotron with a single-stage depressed collector. Conf. Digest 32nd Int. Conf. on Infrared and Millimeter Waves and 15th Int. Conf. on Terahertz Electronics, Cardiff, UK, 98-99.
- [657] Häfner, H.E., Bojarsky, E., Norajitra, P., Reiser, 1992, H. Cryocooled windows for high frequency plasma heating. *Fusion Technology 1992*, eds. C. Ferro, M. Gasparotto, H. Knoepfel (Elsevier Science Publishers B.V. 1992), 520-523.
- [658] Häfner, H.E., Bojarsky, E., Heckert, K., Norajitra, P., Reiser, H., 1994, Liquid nitrogen cooled window for high frequency plasma heating. *Journal of Nuclear Materials*, **212-215**, 1035-1038.
- [659] Häfner, H.E., Heckert, K., Norajitra, P., Vouriot, R., Hofmann, A., Münch, N., Nickel, H.-U., Thumm, M., Erckmann, V., 1994, Investigations of liquid nitrogen cooled windows for high power millimeter wave transmission. Conf. Digest 19th Int. Conf. on Infrared and Millimeter Waves, Sendai, JSAP Catalog No.: **AP 941228**, 281-282.
- [660] Heidinger, R., Link, G., 1995, The mm-wave absorption in sapphire and its description by the 2-phonon model. Conf. Digest 20th Int. Conf. on Infrared and Millimeter Waves, Lake Buena Vista (Orlando), Florida, 16-17.
- [661] Norajitra, P., Häfner, H.E., Thumm, M., 1995, Alternatives for edge cooled single disk windows with 1 MW transmission power. Conf. Digest 20th Int. Conf. on Infrared and Millimeter Waves, Lake Buena Vista (Orlando), Florida, 475-476.
- [662] Saitoh, Y., Itoh, K., Yoshiyuki, T., Ebisawa, K., Yokokura, K., Nagashima, T., Yamamoto, T., 1992, Cryogenic window for millimeter-wave transmission. *Fusion Technology 1992*, eds. C. Ferro, M. Gasparotto, H. Knoepfel (Elsevier Science Publishers B.V. 1992), 632-636.
- [663] Fix, A.S., Sushilin, P.B., 1993, Calculation and experimental investigation of cryogenic window. Proc. 5th Russian-German Meeting on ECRH and Gyrotrons, Karlsruhe, 389-392 and, 1994, Proc. 6th Russian-German Meeting on ECRH and Gyrotrons, Moscow, 1994, **Vol. 2**, 244-247.
- [664] Kasugai, A., Yokokura, K., Sakamoto, K., Tsuneoka, M., Yamamoto, T., Imai, T., Saito, Y., Ito, K., Yoshiyuki, T., Ebisawa, K., 1994, High power tests of the cryogenic window for millimeter wave. Conf. Digest 19th Int. Conf. on Infrared and Millimeter Waves, Sendai, JSAP Catalog No.: **AP 941228**, 295-296.
- [665] Garin, P., Bon-Mardion, G., Pain, M., Heidinger, R., Thumm, M., Dubrovin, A., Giguet, E., Tran, C., 1995, Cryogenically cooled window: a new step toward gyrotron CW operation. Conf. Digest 20th Int. Conf. on Infrared and Millimeter Waves, Lake Buena Vista (Orlando), Florida, 271-272.
- [666] Parshin, V.V., Heidinger, R., Andreev, B.A., Gusev, A.V., Shmagin, V.B., 1995, Silicon with extra low losses for megawatt output gyrotron windows. Conf. Digest 20th Int. Conf. on Infrared and Millimeter Waves, Lake Buena Vista (Orlando), Florida, 22-23, and Parshin, V.V., 1998, private communication.

- [667] Shimosuma, T., Sato, M., Takita, Y., Kubo, S., Idei, H., Ohkubo, K., Watari, T., Morimoto, S., Tajima, K., 1995, Development of elongated vacuum windows for high power CW millimeter waves. Conf. Digest 20th Int. Conf. on Infrared and Millimeter Waves, Lake Buena Vista (Orlando), Florida, 273-274.
- [668] Shimosuma, T., Morimoto, S., Sato, M., Takita, Y., Ito, S., Kubo, S., Idei, H., Okhubo, K., Watari, T., 1997, A forced gas-cooled single disk window for high power cw millimeter waves. Conf. Digest 22nd Int. Conf. on Infrared and Millimeter Waves, Wintergreen, Virginia, USA, 146-147.
- [669] Petelin, M.I., Kasperek, W., 1991, Surface corrugation for broadband matching of windows in powerful microwave generators. *Int. J. Electronics*, **71**, 871-873.
- [670] Nickel, H.-U., Ambrosy, U., Thumm, M., 1992, Vacuum windows for frequency-tunable high-power millimeter wave systems. Conf. Digest 17th Int. Conf. on Infrared and Millimeter Waves, Pasadena, Proc., SPIE **1929**, 462-463.
- [671] Nickel, H.-U., Massler, H., Thumm, M., 1993, Development of broadband vacuum windows for high-power millimeter wave systems. Conf. Digest 18th Int. Conf. on Infrared and Millimeter Waves, Colchester (Essex, UK), Proc., SPIE **2104**, 172-173.
- [672] Shang, C.C., Caplan, M., Nickel, H.-U., Thumm, M., 1993, Electrical analysis of wideband and distributed windows using time-dependent field codes. Conf. Digest 18th Int. Conf. on Infrared and Millimeter Waves, Colchester (Essex, UK), Proc., SPIE **2104**, 178-179.
- [673] Moeller, C.P., Doane, J.L., DiMartino, M., 1994, A vacuum window for a 1 MW CW 110 GHz gyrotron. Conf. Digest 19th Int. Conf. on Infrared and Millimeter Waves, Sendai, Conf. Digest 19th Int. Conf. on Infrared and Millimeter Waves, Sendai, JSAP Catalog No.: **AP 941228**, 279-280.
- [674] Shapiro, M.A., Moeller, C.P., Temkin, R.J., 2002, Electromagnetic analysis and cold test of a distributed window for a high power gyrotron. *Int. J. Infrared and Millimeter Waves*, **20**, 533-542.
- [675] Heidinger, R., 1994, Dielectric property measurements on CVD diamond grades for advanced gyrotron windows. Conf. Digest 19th Int. Conf. on Infrared and Millimeter Waves, Sendai, JSAP Catalog No.: **AP 941228**, 277-278.
- [676] Heidinger, R., Schwab, R., Spörl, R., Thumm, M., 1997, Dielectric loss measurements in CVD diamond windows for gyrotrons. Conf. Digest 22nd Int. Conf. on Infrared and Millimeter Waves, Wintergreen, Virginia, USA, 142-143.
- [677] Braz, O., Kasugai, A., Sakamoto, K., Takahashi, K., Tsuneoka, M., Imai, T., Thumm, 1997, High power 170 GHz test of CVD diamond for ECH window. *Int. J. Infrared and Millimeter Waves*, **18**, 1495-1503.
- [678] Thumm, M., 1998, Development of output windows for high-power long-pulse gyrotrons and EC wave applications. *Int. J. Infrared and Millimeter Waves*, **19**, 3-14.
- [679] Heidinger, R., Spörl, R., Thumm, M., Brandon, J.R., Sussmann, R.S., Dodge, C.N., 1998, CVD diamond windows for high power gyrotrons. Conf. Digest 23rd Int. Conf. on Infrared and Millimeter Waves, Colchester, U.K., 223-225.
- [680] Kasugai, A., Sakamoto, K., Takahashi, K., Tsuneoka, M., Kariya, T., Imai, T., Braz, O., Thumm, M., Brandon, J.R., Sussmann, R.S., Beale, A., Ballington, D.C., 1998, Chemical vapor deposition diamond for high-power and long-pulse millimeter wave transmission. *Rev. Scientific Instruments*, **69**, 2160-2165.
- [681] Thumm, M., Braz, O., Heidinger, R., Makowski, M., Spörl, R., 1999, Design and optimization of the ITER ECRF window unit. Conf. Digest 24th Int. Conf. on Infrared and Millimeter Waves, Monterey, California, USA, PS-5.
- [682] Spörl, R., Heidinger, R., Schwab, R., 1999, Dielectric characterisation of CVD diamond windows at elevated temperatures. Conf. Digest 24th Int. Conf. on Infrared and Millimeter Waves, Monterey, California, USA, F-A9.

- [683] Thumm, M., Alberti, S., Arnold, A., Borie, E., Dammertz, G., Erckmann, V., Garin, P., Giguet, E., Illy, S., Le Cloarec, G., Le Goff, Y., Magne, R., Michel, G., Piosczyk, B., Tran, M.Q., Wagner, D., 1999, 1 MW, 140 GHz, CW gyrotron for Wendelstein-7-X. Conf. Digest 24th Int. Conf. on Infrared and Millimeter Waves, Monterey, California, USA, Plenary W-2.
- [684] Thumm, M., Arnold, A., Heidinger, R., Rohde, M., Schwab, R., Spoerl, R., 2001, Status report on CVD diamond window development for high power ECRH. Fusion Engineering and Design, **53**, 517-524.
- [685] Brandon, J.R., Coe, S.E., Sussmann, R.S., Sakamoto, K., Spoerl, R., Heidinger, R., Hanks, S., 2001, Development of CVD diamond r.f. windows for ECRH. Fusion Engineering and Design, **53**, 553-559.
- [686] Heidinger, R., Meier, A., Rohde, M., Spörl, R., Thumm, M., Arnold, A., 2000, Millimeter wave characterisation of large area MPACVD diamond windows. Conf. Digest 25th Int. Conf. on Infrared and Millimeter Waves, Beijing, P.R. China, 389-390.
- [687] Petelin, M.I., 1999, Microwave applications of gratings. Proc. 4th Int. Workshop on Strong Microwaves in Plasmas, Nizhny Novgorod, ed. A.G. Litvak, Inst. of Applied Physics, Russian Academy of Sciences, Nizhny Novgorod, 2000, **Vol. 2**, 930-941.
- [688] Thumm, M., 2001, MPACVD-diamond windows for high-power and long-pulse millimeter wave transmission. Diamond and Related Materials, **10**, 1692-1699.
- [689] Heidinger, R., Meier, A., Thumm, M., 2001, Dielectric loss studies in diamond window components for megawatt gyrotrons. Proc. 2nd IEEE Int. Vacuum Electronics Conference (IVEC 2001), Noordwijk, Netherlands, 227-230.
- [690] Heidinger, R., Meier, A., Thumm, M., Arnold, A., 2001, MPACVD diamond discs characterised as window components for megawatt gyrotrons. Proc. 9th Int. Conf. Displays and Vacuum Electronics, Garmisch-Partenkirchen, ITG-Fachbericht **165**, 357-362.
- [691] Heidinger, R., Dammertz, G., Meier, A., Thumm, M.K., 2002, CVD diamond windows studied with low- and high-power millimeter waves. IEEE Trans. on Plasma Science, **PS-30**, 800-807.
- [692] Yang, X., Wagner, D., Piosczyk, B., Koppenburg, K., Borie, E., Heidinger, R., Leuterer, F., Dammertz, G., Thumm, M., 2003, Analysis of transmission characteristics for single and double disk windows. Int. J. of Infrared and Millimeter Waves, **24**, 619-628.
- [693] Yang, X., Piosczyk, B., Heidinger, R., Thumm, M., 2003, A double disk window for the JET EP ECRH system. Fusion Engineering and Design, **66-68**, 633-637.
- [694] Yang, X., Borie, E., Dammertz, G., Heidinger, R., Koppenburg, K., Leuterer, F., Piosczyk, B., Wagner, D., Thumm, M., 2003, The influence of window parameters on the transmission characteristics of millimeter waves. Int. J. of Infrared and Millimeter Waves, **24**, 1805-1813.
- [695] Yang, X., Dammertz, G., Heidinger, R., Koppenburg, K., Leuterer, F., Meier, A., Piosczyk, B., Wagner, D., Thumm, M., 2005, Design of an ultra-broadband single-disk output window for a frequency step-tunable 1 MW gyrotron. Fusion Eng. and Design, **74**, 489-493.
- [696] Danilov, I., Heidinger, R., Meier, A., Thumm, M., 2004, Design and thermo-mechanical analysis of a double disk window for step-tuneable gyrotrons. Proc. 10th Int. Conf. Displays and Vacuum Electronics, Garmisch-Partenkirchen, ITG-Fachbericht **183**, 301-304.
- [697] Takahashi, K., Illy, S., Heidinger, R., Kasugai, A., Minami, R., Sakamoto, K., Thumm, M., Imai, T., 2005, Development of reliable diamond window for EC launcher on fusion reactors. Fusion Eng. and Design, **74**, 305-310.
- [698] Danilov, I., Heidinger, R., Meier, A., Piosczyk, B., Schmid, M., Späh, P., Bongers, W., Graswinckel, M., Lamers, B., Verhoeven, A.G.A., 2007, High-power short-pulse, mechanical, and thermohydraulic tests of the window prototype for remote steering launcher. Fusion Science and Technology, **52**, 250-255.

- [699] Heidinger, R., Danilov, I., Meier, A., Piosczyk, B., Späh, P., Thumm, M., Bongers, W., Graswinckel, M., Henderson, M., Leuterer, F., Verhoeven, A.G.A., Wagner, D., 2007, Development of high power window prototypes or ECH&CD launchers, *Fusion Engineering and Design*, **82**, 693-699.
- [700] Heidinger, R., Danilov, I., Meier, A., Arnold, A., Flamm, J., Thumm, M., Leuterer, F., Stober, J., Wagner, D., 2007, Low power mm-wave transmission characteristics of a frequency tuneable double disk CVD-diamond, *Conf. Digest Joint 32nd Int. Conf. on Infrared and Millimetre Waves and 15th Int. Conf. on Terahertz Electronics*, Cardiff, UK, pp. 877-879, Invited Paper.
- [701] Flamm, J., Schlaich, A., Arnold, A., Prinz, O., Heidinger, R., Thumm, M., 2008, Characterization of windows for fusion applications using a D-band network analyzer, *Proc. 33rd Int. Conf. on Infrared, Millimeter and Terahertz Waves*, Pasadena, CA, USA, T4A2.1535.
- [702] Scherer, T.A., Heidinger, R., Meier, A., Strauss, D., Takahashi, K., Kajiwara, K., Sakamoto, K., 2008, Experimental and theoretical thermal analysis of CVD diamond window units for the ITER upper launcher, *Proc. 33rd Int. Conf. on Infrared, Millimeter and Terahertz Waves*, Pasadena, CA, USA, T5D32.1206.
- [703] Belousov, V.I., Denisov, G.G., Filchenkov, S.E., Kovalev, N.F., Petelin, M.I., 2009, Broad band matched windows for gyrotrons, *Proc. 34th Int. Conf. on Infrared, Millimeter and Terahertz Waves*, Busan, Korea, R3D06.0183.
- [704] Yu, G., Dutta, J.M., Jones, C.R., 2004, Potentials of SiC as a gyrotron window material. *Conf. Digest 29th Int. Conf. on Infrared and Millimeter Waves and 12th Int. Conf. on Terahertz Electronics*, Karlsruhe, Germany, 299-300.
- [705] Dutta, J.M., Jones, C.R., Parshin, V.V., Garin, B., Polyakov, V.I., Rukovishnikov, A., 2008, Electrically active defects and dielectric loss in silicon carbide, *Proc. 33rd Int. Conf. on Infrared, Millimeter and Terahertz Waves*, Pasadena, CA, USA, M5D4.1629.
- [706] Jones, C.R., Dutta, J., Yu, G., Gao, Y., 2011, Measurement of dielectric properties for low-loss materials at millimeter wavelengths, *J. Infrared Milli Terahz Waves*, **32**, 838-847.
- [707] Mocheneva, O.S., Parshin, V.V., 2006, The scattering of subMM waves by microcaverns in CVD-diamond windows. *Conf. Digest 31st Int. Conf. on Infrared and Millimeter Waves and 14th Int. Conf. on Terahertz Electronics*, Shanghai, China, 182.
- [708] Scherer, T.A., Aiello, G., Grossetti, G., Meier, A., Schreck, S., Spaeh, P., Strauss, D., Vaccaro, A., Siegel, M., Meckbach, J.M., Scheuring, A., 2012, Reduction of surface losses of CVD diamond by passivation methods, *38th Int. Conf. on Infrared, Millimeter and Terahertz Waves (IRMMW-THz 2012)*, Wollongong, Australia, Sept 23-28, 2012, Tue-B-22.
- [709] Read, M., Lawrence Ives, R., Neilson, J., Tax, D., Temkin, R., Doane, J., 2012, A wide-band window in HE_{1,1} guide for gyrotrons, *38th Int. Conf. on Infrared, Millimeter and Terahertz Waves (IRMMW-THz 2012)*, Wollongong, Australia, Sept 23-28, 2012, Tue-Pos-30.
- [710] Bohlen, H., Eisen, E., Felch, K., Jory, H., Lenci, S., Wright, E., 1998, New high-power microwave tubes for scientific industrial and broadcast applications. *Proc. 8th ITG-Conference on Displays and Vacuum Electronics*, Garmisch-Partenkirchen, ITG-Fachbericht **150**, 248-256.
Jory, H., 1997, *Communications & Power Industries*, Palo Alto, private communication.
- [711] Zaytsev, N.I., Pankratova, T.P., Petelin, M.I., Flyagin, V.A., 1974, Millimeter- and submillimeter-wave gyrotrons. *Radio Eng. and Electronic Phys.*, **19**, 103-107.

- [712] Spira-Hakkarainen, S.E., Kreischer, K.E., Temkin, R.J., 1990, Submillimeter-wave harmonic gyrotron experiment. *IEEE Trans. Plasma Science*, **PS-18**, 334-342.
Kreischer, K.E., Grimm, T.L., Guss, W.C., Temkin, R.J., Xu, K.Y., 1990, Research at MIT on high frequency gyrotrons for ECRH. *Proc. Int. Workshop on Strong Microwaves in Plasmas*, Suzdal, Inst. of Applied Physics, Nizhny Novgorod, 1991, 713-725.
- [713] Kreischer, K., Farrar, C., Griffin, R., Temkin, R., Viereg, J., 1999, The development of a 250 GHz cw gyrotron for EPR and NMR spectroscopy. *Conf. Digest 24th Int. Conf. on Infrared and Millimeter Waves*, Monterey, California, USA, TU-A3.
- [714] Yan, Y.Y., Fu, W.F., Li, X.L., Yuan, X.Y., Liu, S.L., 2010, Experimental results of a 0.42 THz harmonic gyrotron, *Proc. 35th Int. Conf. on Infrared, Millimeter and Terahertz Waves*, Rome, Italy, Th-P.50.
- [715] Idehara, T., Tatsukawa, T., Ogawa, I., Tanabe, H., Mori, T., Wada, S., Brand, G.F., Brennan, M.H., 1992, Development of a second cyclotron harmonic gyrotron operating at submillimeter wavelengths. *Phys. Fluids* **B4**, 267-273 and 1993, *Phys. Fluids* **B5**, 1377-1379.
- [716] Shimizu, Y., Makino, S., Ichikawa, K., Kanemaki, T., Tatsukawa, T., Idehara, T., Ogawa, I., 1995, Development of submillimeter wave gyrotron using 12 T superconducting magnet. *Phys. Plasmas*, **2**, 2110-2116.
- [717] Idehara, T., Shimizu, Y., Ichikawa, K., Makino, S., Shibutani, K., Kurahashi, K., Tatsukawa, T., Ogawa, I., Okazaki, Y., Okamoto, T., 1995, Development of a medium power, submillimeter wave gyrotron using a 17 T superconducting magnet. *Phys. Plasmas*, **2**, 3246-3248.
- [718] Idehara, T., Tatsukawa, T., Ogawa, I., Shimizu, Y., Kurahashi, K., Nishida, N., Yoshida, K., 1996, Development of terahertz gyrotron using a 17T superconducting magnet. *Proc. 21st Int. Conf. on Infrared and Millimeter Waves*, Berlin, AT9.
- [719] Idehara, T., Nishida, N., Yoshida, K., Ogawa, I., Tatsukawa, T., Wagner, D., Gantenbein, G., Kasperek, W., Thumm, M., 1998, High frequency and high mode purity operations of gyrotron FU IVA. *Int. J. Infrared and Millimeter Waves*, **19**, 919-930.
- [720] Idehara, T., Ogawa, I., Mitsudo, S., Pereyaslavets, M.L., Tsuchida, T., Ui, M., 1998, Development of a submillimeter wave gyrotron (gyrotron FU V). *Conf. Digest 23rd Int. Conf. on Infrared and Millimeter Waves*, Colchester, UK, 398-399.
- [721] Idehara, T., Ogawa, I., Mitsudo, S., Pereyaslavets, M., Nishida, N., Yoshida, K., 1999, Development of frequency tunable, medium power gyrotrons (Gyrotron FU Series) as submillimeter wave radiation sources. *IEEE Trans. on Plasma Science*, **PS-27**, 340-354.
- [722] Ogawa, I., Idehara, T., Iwata, Y., Pavlichenko, R., Mitsudo, S., Wagner, D., Thumm, M., 2002, High quality operation of high frequency gyrotron. *Proc. 27th Int. Conf. on Infrared and Millimeter Waves*, San Diego, USA, 293-294.
Wagner, D., Gantenbein, G., Kasperek, W., Thumm, M., 1995, Improved gyrotron cavity with high quality factor. *Int. J. Infrared and Millimeter Waves*, **16**, 1481-1489.
- [723] Idehara, T., Mitsudo, S., Pavlichenko, R., Ogawa, I., Wagner, D., Thumm, M., 2002, Development of submillimeter wave gyrotron FU series. *Proc. 5th Int. Workshop on Strong Microwaves in Plasmas*, Nizhny Novgorod, ed. A.G. Litvak, Inst. of Applied Physics, Russian Academy of Sciences, Nizhny Novgorod, 2003, **Vol. 1**, 116-128.
- [724] Idehara, T., Ogawa, I., Mitsudo, S., 2003, Present status of gyrotron FU series. *Conf. Digest 28th Int. Conf. on Infrared and Millimeter Waves*, Otsu, Japan, 251-252.
- [725] Ogawa, I., Idehara, T., Itakura, Y., Wagner, D., Thumm, M., 2003, High purity mode operation of gyrotron FU VA and generation of intense gaussian beam. *Conf. Digest 28th Int. Conf. on Infrared and Millimeter Waves*, Otsu, Japan, 289-290.
- [726] Ogawa, I., Idehara, T., Itakura, Y., Hori, T., Wagner, D., Thumm, M., 2004, Conversion of gyrotron output into Gaussian beam and its application to plasma diagnostics. *Proc. 10th Int. Conf. Displays and Vacuum Electronics*, Garmisch-Partenkirchen, ITG-Fachbericht **183**, 201-204.

- [727] Ogawa, I., Idehara, T., Sasagawa, H., Kimura, A., Mitsudo, S., Hori, T., Wagner, D., Thumm, M., 2004, High quality operation of gyrotron aiming toward the convenient radiation source in the submillimeter wave length range. Proc. 10th Int. Conf. Displays and Vacuum Electronics, Garmisch-Partenkirchen, ITG-Fachbericht **183**, 371-374.
- [728] Idehara, T., Ogawa, I., Iwata, Y., Kanemaki, T., Ohashi, K., Kobayashi, H., Yokoyama, T., Glyavin, M., Sabchevski, S., 2003, Development of a large orbit gyrotron (LOG). Conf. Digest 28th Int. Conf. on Infrared and Millimeter Waves, Otsu, Japan, 285-286.
- [729] Idehara, T., Ogawa, I., Mitsudo, S., Watanabe, S., Sato, N., Ohashi, K., Kobayashi, H., Yokoyama, T., Zapevalov, V., Glyavin, M., Kuftin, A., Malygin, O., Sabchevski, S., 2004, A high harmonic gyrotron and a gyro-peniotron with an axis-encircling electron beam and a permanent magnet. Proc. 10th Int. Conf. Displays and Vacuum Electronics, Garmisch-Partenkirchen, ITG-Fachbericht **183**, 51-54.
- [730] Idehara, T., Watanabe, O., Kamada, M., Agusu, L., Yatsui, K., Jiang, W., Manuilov, V.N., Glyavin, M.Yu., 2004, Powerful large orbit gyrotron of submillimeter wavelength range. Conf. Digest 29th Int. Conf. on Infrared and Millimeter Waves and 12th Int. Conf. on Terahertz Electronics, Karlsruhe, Germany, 625-626.
- [731] Idehara, T., Ogawa, I., Mitsudo, S., Iwata, Y., Watanabe, S., Itakura, Y., Ohashi, K., Kobayashi, H., Yokoyama, T., Zapevalov, V.E., Glyavin, M.Yu., Kuftin, A.N., Malygin, O.V., Sabchevski, S.P., 2004, A high harmonic gyrotron with an axis-encircling electron beam and a permanent magnet. IEEE Trans. on Plasma Science, **PS-32**, 903-909.
- [732] Idehara, T., Ogawa, I., Mitsudo, S., Iwata, Y., Watanabe, S., Itakura, Y., Ohashi, K., Kobayashi, H., Yokoyama, T., Zapevalov, V., Glyavin, M., Kuftin, A., Malygin, O., Sabchevski, S., 2005, Development of a high harmonic gyrotron with an axis-encircling electron beam and a permanent magnet. Vacuum, **77**, 539-546.
- [733] Idehara, T., Ogawa, I., Mitsudo, S., Iwata, Y., Watanabe, S., Itakura, Y., Agusu, L., Ohashi, K., Kobayashi, H., Yokoyama, T., Zapevalov, V., Glyavin, M., Kuftin, A., Malygin, O., Sabchevski, S., 2005, Development of a large orbit gyrotron (LOG) operating at higher harmonics. Conf. Digest 30th Int. Conf. on Infrared and Millimeter Waves and 13th Int. Conf. on Terahertz Electronics, Williamsburg, VA, USA, 525-526.
- [734] Bratman, V.L., Kalynov, Y.K., Manuilov, V.N., 2009, A 1-THz third-harmonic large-orbit gyrotron, Proc. 34th Int. Conf. on Infrared, Millimeter and Terahertz Waves, Busan, Korea, M4D01.0118.
- [735] Xu, K.Y., Kreisler, K.E., Guss, W.C., Grimm, T.L., Temkin, R.J., 1990, Efficient operation of a megawatt gyrotron. Conf. Digest 15th Int. Conf. on Infrared and Millimeter Waves, Orlando, Proc., SPIE **1514**, 324-326.
- [736] Grimm, T.L., Kreisler, K.E., Guss, W.C., Temkin, R.J., 1992, Experimental study of a megawatt 200-300 GHz gyrotron oscillator. Fusion Technology, **21**, 1648-1657 and, 1993, Phys. Fluids, **B5**, 4135-4143.
- [737] Grimm, T.L., Borchard, P.M., Kreisler, K.E., Guss, W.C., Temkin, R.J., 1992, High power operation of a 200-300 GHz gyrotron oscillator and multimewatt gyrotrons for ITER. Conf. Digest 17th Int. Conf. on Infrared and Millimeter Waves, Pasadena, Proc., SPIE **1929**, 190-191 and 194-195.
- [738] Kimura, T., Danly, B.G., Kreisler, K.E., Temkin, R.J., 1995, Development of a 1 MW, 170 GHz gyrotron with internal mode converter. Conf. Digest 20th Int. Conf. on Infrared and Millimeter Waves, Lake Buena Vista (Orlando), Florida, 201-202.
- [739] Sirigiri, J.R., Kreisler, K.E., Machuzak, J., Mastovsky, I., Shapiro, M.A., Temkin, R.J., 2001, Photonic-band-gap resonator gyrotron. Phys. Rev. Lett., **86**, 5628-5631.
- [740] Choi, E.M., Shapiro, M.A., Sirigiri, J.R., Temkin, R.J., 2006, Experimental study of a high efficiency 1.5 MW, 110 GHz gyrotron. Proc. Int. Vacuum Electronics Conference and Int. Vacuum Electron Sources (IVEC/IVESC 2006), Monterey, California, USA, 417-418.

- [741] Choi, E.M., Shapiro, M.A., Sirigiri, J.R., Temkin, R.J., 2006, Single-stage depressed collector experimental results from a 110 GHz 1.5 MW gyrotron at MIT. Conf. Digest 31st Int. Conf. on Infrared and Millimeter Waves and 14th Int. Conf. on Terahertz Electronics, Shanghai, China, 22.
- [742] Choi, E.M., Marchewka, C.D., Mastovsky, I., Sirigiri, J.R., Shapiro, M.A., Temkin, R.J., 2006, Experimental results for a 1.5 MW, 110 GHz gyrotron oscillator with reduced mode competition. *Physics of Plasmas*, **13**, 023103-1-023103-7.
- [743] Hidaka, Y., Choi, E.M., Shapiro, M.A., Sirigiri, J.R., Temkin, R.J., 2008, Study of after cavity interaction in a high efficiency 1.5 MW, 110 GHz gyrotron, Proc. 9th IEEE Int. Vacuum Electronics Conference (IVEC 2008), Monterey, CA, USA, 66-67.
- [744] Hikada, Y., Choi, E.M., Mastovsky, I., Shapiro, M.A., Sirigiri, J.R., Temkin, R.J., 2008, Effects of after cavity interaction in a 1.5 MW, 110 GHz gyrotron with a depressed collector, Proc. 33rd Int. Conf. on Infrared, Millimeter and Terahertz Waves, Pasadena, CA, USA, T2A4.1545.
- [745] Tax, D.S., Choi, E.M., Hidaka, Y., Mastovsky, I., Shapiro, M.A., Sirigiri, J.R., Tempin, R.J., Torrezan, A.C., Neilson, J., 2010, Operation of a 1.5 MW, 110 GHz gyrotron with an advanced internal mode converter, Proc. 11th IEEE Int. Vacuum Electronics Conference (IVEC 2010), Monterey, USA, pp. 313-314.
- [746] Tax, D.S., Choi, E.M., Mastovsky, I., Neilson, J.M., Shapiro, M.A., Sirigiri, J.R., Temkin, R.J., Torrezan, A.C., 2011, Experimental results on a 1.5 MW, 110 GHz gyrotron with a smooth mirror mode converter, *J. of Infrared Milli Terahz Waves*, **32**, 358-370.
- [747] Fu, W., Yan, Y., Li, X., Liu, S., 2010, The experiment of a 220 GHz gyrotron with a pulse magnet, *J Infrared Milli Terahz Waves*, **31**, 404-410.
- [748] Brand, G.F., Fekete, P.W., Hong, K., Moore, K.J., Idehara, T., 1990, Operation of a tunable gyrotron at the second harmonic of the electron cyclotron frequency. *Int. J. Electronics*, **68**, 1099-1111.
- [749] Hong, K.D., Brand, G.F., 1993, A 150-600 GHz step-tunable gyrotron. *J. Appl. Phys.*, **74**, 5250-5258.
- [750] Idehara, T., Kamada, M., Tsuchiya, H., Hayashi, T., Agusu, La, Mitsudo, S., Ogawa, I., Manuilov, V.N., Naito, K., Yuyama, T., Jiang, W., Yatsui, K., 2005, Development of an ultra high frequency gyrotron with a pulsed magnet. Proc. 7th Workshop on High Energy Density and High Power RF, AIP Conference Proceedings **807**, 2006, 197-205.
- [751] Idehara, T., Tsuchiya, H., L. Agusu, Mori, H., Murase, H., Watanabe, O., Saito, T., Ogawa, I., Mitsudo, S., 2006, Development of a THz gyrotron. Conf. Digest 31st Int. Conf. on Infrared and Millimeter Waves and 14th Int. Conf. on Terahertz Electronics, Shanghai, China, 509.
- [752] Idehara, T., Tsuchiya, H., Agusu, La, Mitsudo, S., Murase, H., Mori, H., Kanemaki, T., Saito, T., 2006, Development of a THz gyrotron with 20 T pulsed magnet. *Journal of Physics: Conference Series*, **51**, 553-556.
- [753] Idehara, T., Tsuchiya, H., Agusu, L., Mori, H., Murase, H., Saito, T., Ogawa, I., Mitsudo, S., 2007, Development of CW THz gyrotrons in FIR FU, Proc. 8th IEEE Int. Vacuum Electronics Conference (IVEC 2007), Kitakyushu, Japan, 341-342.
- [754] Agusu, L., Tsuchiya, H., Mori, H., Idehara, T., Saito, T., Ogawa, I., Mitsudo, S., 2007, The experimental results and theoretical analysis of a THz gyrotron using a 21 T pulse magnet at FIR FU, Proc. 8th IEEE Int. Vacuum Electronics Conference (IVEC 2007), Kitakyushu, Japan, 343-344.
- [755] Idehara, T., Tsuchiya, H., Agusu, L., Mori, H., Murase, H., Saito, T., Ogawa, I., Mitsudo, S., 2007, The 1 THz gyrotron at Fukui University. Conf. Digest 32nd Int. Conf. on Infrared and Millimeter Waves and 15th Int. Conf. on Terahertz Electronics, Cardiff, UK, 309-311.

- [756] Denisov, G.G., Antakov, I.I., Gachev, I.G., Lygin, V.K., Sokolov, E.V., Zasyupkin, E.V., 2005, Studying of the 95/285 GHz gyrotron with frequency multiplication. Conf. Digest 30th Int. Conf. on Infrared and Millimeter Waves and 13th Int. Conf. on Terahertz Electronics, Williamsburg, VA, USA, 435-436.
- [757] Bandurkin, I.V., Bratman, V.L., Denisov, G.G., Savilov, A.V., 2005, Frequency multiplication in gyro-oscillators. Proc. 6th Int. Workshop on Strong Microwaves in Plasmas, Nizhny Novgorod, ed. A.G. Litvak, Inst. of Applied Physics, Russian Academy of Sciences, Nizhny Novgorod, 2006, **Vol. 1**, 156-161.
- [758] Antakov, I.I., Gachev, I.G., Denisov, G.G., Lygin, V.K., Zasyupkin, E.V., 2005, Development and experimental study of a two-cavity 285 GHz CW gyrotron-multiplier. Proc. 6th Int. Workshop on Strong Microwaves in Plasmas, Nizhny Novgorod, ed. A.G. Litvak, Inst. of Applied Physics, Russian Academy of Sciences, Nizhny Novgorod, 2006, **Vol. 1**, 162-166.
- [759] Bandurkin, I.V., Bratman, V.L., Denisov, G.G., Gachev, I.G., Kalynov, Yu.K., Savilov, A.V., 2006, New schemes of high-harmonic gyro-devices with frequency multiplication. Conf. Digest 31st Int. Conf. on Infrared and Millimeter Waves and 14th Int. Conf. on Terahertz Electronics, Shanghai, China, 83.
- [760] Bandurkin, I.Y., Bratman, V.L., Kalynov, Y.K., Manuilov, V.N., Samsonov, S.V., Savilov, A.V., 2008, Terahertz high-harmonic gyrotrons and gyro-multipliers, Proc. 33rd Int. Conf. on Infrared, Millimeter and Terahertz Waves, Pasadena, CA, USA, M2A4.1449.
- [761] Bandurkin, I.V., Bratman, V.L., Savilov, A.V., Samsonov, S.V., Volkov, A.B., 2009, Progress in studying a self-excited gyromultiplier, Proc. 34th Int. Conf. on Infrared, Millimeter and Terahertz Waves, Busan, Korea, M4D02.0342.
- [762] Bandurkin, I.V., Bratman, V.L., Savilov, A.V., Samsonov, S.V., Volkov, A.B., 2009, Experimental study of a fourth-harmonic gyromultiplier, *Physics of Plasmas*, **16**, 070701-1 – 070701-3.
- [763] Antakov, I.I., Gachev, I.G., Kurbatov, V.I., Sokolov, E.V., Solujanova, E.A., Zasyupkin, E.V., 1996, A Ka-band 10 kW CW efficient compact gyrotron for materials processing. Proc. 21st Int. Conf. on Infrared and Millimeter Waves, Berlin, AM3.
- [764] Antakov, I.I., Gachev, I.G., Kurbatov, V.I., Sokolov, E.V., Solujanova, E.A., Zasyupkin, E.V., 1996, Ka-band and W-band 10 kW CW high efficiency gyrotrons for materials processing. Proc. 3rd Int. Workshop on Strong Microwaves in Plasmas, Nizhny Novgorod, 1997, **Vol.2**, 679-687.
- [765] Flyagin, V.A., Kuftin, A.N., Lygin, V.K., Luchinin, A.G., Malygin, O.V., Manuilov, V.N., Tsimring, Sh.E., Zapevalov, V.E., 1996, CW 10 kW technological gyrotron in the range 15-50 GHz. Proc. 3rd Int. Workshop on Strong Microwaves in Plasmas, Nizhny Novgorod, 1997, **Vol.2**, 711-716.
- [766] Zasyupkin, E.V., Antakov, I.I., Gachev, I.G., Vlasov, S.N., Sokolov, E.V., 1998, Continuously tunable 35-190 GHz powerful gyrotrons at GYCOM. Conf. Digest 23rd Int. Conf. on Infrared and Millimeter Waves, Colchester, UK, 323-324.
Zasyupkin, E.V., Moiseev, M.A., Nemirovskaya, L.L., 1998, Expansion of a frequency tuning band in a frequency band in a gyrotron with coupled cavities. *Int. J. Electronics*, **85**, 207-216.
- [767] Möbius, A., 1995, A permanent magnet system for gyrotrons. Conf. Digest 20th Int. Conf. on Infrared and Millimeter Waves, Lake Buena Vista (Orlando), Florida, and Millimeter Waves, Lake Buena Vista (Orlando), Florida, 487-488.
- [768] Glyavin, M., Goldenberg, A., Flyagin, V., Kuftin, A., Luchinin, A., Lygin, V., Malygin, O., Manuilov, V., Moiseev, M., Zavolsky, N., Zapevalov, V., 1999, Experimental investigation of technological gyrotrons. Proc. Int. University Conf. "Electronics and Radiophysics of Ultra-High Frequencies" (UHF-99), 1999, St. Petersburg, Russia, 112.

- [769] Bykov, Yu., Glyavin, M., Goldenberg, A., Luchinin, A., Lygin, V., Zavol'skii, N., 1999, Efficient 24-30 GHz CW gyrotrons for technological applications. Proc. 4th Int. Workshop on Strong Microwaves in Plasmas, Nizhny Novgorod, ed. A.G. Litvak, Inst. of Applied Physics, Russian Academy of Sciences, Nizhny Novgorod, 2000, **Vol. 2**, 747-750.
- [770] Bykov, Y., Glyavin, M., Denisov, G., Holoptsev, V., Ereemeev, A., Plotnikov, I., Pavlov, V., 2001, 3.5 kW 24 GHz compact gyrotron system for microwave processing of materials. Proc. 8th Int. Conf. on Microwave and High Frequency Heating, Bayreuth, 89.
- [771] Denisov, G.G., Bykov, Yu.V., Ereemeev, A.G., Holoptsev, V.V., Glyavin, M.Yu., Luchinin, A.G., Kalynova, G.I., Plotnikov, I.V., Samsonov, S.V., 2005, Development of gyrotron-based technological systems at Gycom / IAP. Conf. Digest 30th Int. Conf. on Infrared and Millimeter Waves and 13th Int. Conf. on Terahertz Electronics, Williamsburg, VA, USA, 28-29.
- [772] Morozkin, M.V., Glyavin, M.Yu., Denisov, G.G., Luchinin, A.G., 2008, A high-efficiency second-harmonic gyrotron with a depressed collector. Int. J. Infrared and Millimeter Waves, **29**, 1004-1010.
- [773] Bykov, Yu.V., Denisov, G.G., Glyavin, M.Yu., Goldenberg, A.L., Luchinin, A.G., Morozkin, M.V., Sobolev, D.I., 2008, The second harmonic gyrotron with record efficiency, Proc. 7th Int. Workshop on Strong Microwaves: Sources and Applications, Nizhny Novgorod, ed. A.G. Litvak, Inst. of Applied Physics, Russian Academy of Sciences, Nizhny Novgorod, 2009, **Vol. 1**, pp. 134-138.
- [774] Glyavin, M.Yu., Denisov, G.G., Luchinin, A.G., Morozkin, M.V., Sobolev, D.I., 2009, Experimental study of a gyrotron operated at the second gyrofrequency harmonic with the single-stage energy recovery, Radiophysics and Quantum Electronics, **51**, 768-771.
- [775] Glyavin, M.Yu., Luchinin, A.G., Morozkin, M.V., 2011, Technological gyrotron with the wide-band fast frequency sweeping, Proc. 8th Int. Workshop Strong Microwaves and Terahertz Waves: Sources and Applications, Nizhny Novgorod – St. Petersburg, Russia, July 9-16, 2011, pp. 107-108.
- [776] Glyavin, M., Luchinin, A., Morozkin, M., 2012, The Ka-band 10-kW continuous wave gyrotron with wide-band fast frequency sweep. Review of Scientific Instruments, **83**, 074706 (3 pp).
- [777] Huey, H., 2010, Micramics, Inc., San Jose, CA, USA, private communication.
- [778] Kikunaga, T., Asano, H., Hemmi, K., Sato, F., Tsukamoto, T., 1995, A 28 GHz gyrotron with a permanent magnet system. Conf. Digest 20th Int. Conf. on Infrared and Millimeter Waves, Lake Buena Vista (Orlando), Florida, 485-486.
- [779] Takada, T., Ohashi, K., Honshima, M., Kikunaga, T., 1995, Nd-Te-B permanent magnet circuit for a 28 GHz CW gyrotron. Conf. Digest 20th Int. Conf. on Infrared and Millimeter Waves, Lake Buena Vista (Orlando), Florida, and Millimeter Waves, Lake Buena Vista (Orlando), Florida, 489-490.
- [780] Asano, H., Kikunaga, K., Hemmi, K., Sato, F., Tsukamoto, T., 1996, A 28 GHz gyrotron with a permanent magnet system for industry applications. Proc. 21st Int. Conf. on Infrared and Millimeter Waves, Berlin, AM5.
- [781] Wang, W., Yu, G., Xu, M., Gong, Y., 2003, 8mm TE₁₃ mode gyrotron. Int. J. of Infrared and Millimeter Waves, **24**, 661-668.
- [782] Zapevalov, V.E., Lygin, V.K., Malygin, O.V., Moiseev, M.A., Khizhnjak, V.I., Karpov, V.P., Tai, E.M., Idehara, T., Ogawa, I., Mitsudo, S., 2005, Development of the 300 GHz/4 kW/CW gyrotron. Proc. 6th IEEE Int. Vacuum Electronics Conf. (IVEC 2005), Noordwijk, The Netherlands, 121-122.
- [783] Hoshizuki, H., Matsuura, K., Mitsuso, S., Idehara, T., Malygin, O.V., Khizhnjak, V.I., Zapevalov, V.E., Ueda, T., Furuiti, M., Kitano, A., Nishi, H., Ishibashi, J., 2005, Development of the material processing system by using a 300 GHz gyrotron. Conf. Digest 30th Int. Conf. on Infrared and Millimeter Waves and 13th Int. Conf. on Terahertz Electronics, Williamsburg, VA, USA, 375-376.

- [784] Zapevalov, V.E., Lygin, V.K., Malygin, O.V., Moiseev, M.A., Karpov, V.P., Khizhnjak, V.I., Tai, E.M., Idehara, T., Ogawa, I., Mitsudo, S., 2005, Development of the 300 GHz /4 kW/CW gyrotron. Proc. 6th Int. Workshop on Strong Microwaves in Plasmas, Nizhny Novgorod, ed. A.G. Litvak, Inst. of Applied Physics, Russian Academy of Sciences, Nizhny Novgorod, 2006, **Vol. 1**, 167-172.
- [785] Saito, T., Idehara, T., Mitsudo, S., Ogawa, I., Hoshizuki, H., Murase, H., Sakai, K., Zapevalov, V.E., Malygin, O.V., Khizhnjak, V.I., Karpov, V.P., Tai, E.M., 2006, Oscillation characteristics of CW 300 GHz gyrotron FU CWI. Conf. Digest 31st Int. Conf. on Infrared and Millimeter Waves and 14th Int. Conf. on Terahertz Electronics, Shanghai, China, 24.
- [786] Mitsudo, S., Sakai, K., Idehara, T., Saito, T., 2006, 300 GHz gyrotron material processing system. Conf. Digest 31st Int. Conf. on Infrared and Millimeter Waves and 14th Int. Conf. on Terahertz Electronics, Shanghai, China, 572.
- [787] Saito, T., Nakano, T., Hoshizuki, H., Sakai, K., Tatematsu, Y., Mitsudo, S., Ogawa, I., Idehara, T., Zapevalov, V.E., 2007, Performance test of CW 300 GHz gyrotron FU CWI. Int. J. Infrared and Millimeter Waves, **28**, 1063-1078.
- [788] Saito, T., Nakano, T., Tatematsu, Y., Mitsudo, S., Idehara, T., Zapevalov, V.E., 2008, Operation improvement of CW 300 GHz gyrotron FU CWI, Proc. 33rd Int. Conf. on Infrared, Millimeter and Terahertz Waves, Pasadena, CA, USA, F2A3.1207.
- [789] Zapevalov, V.E., Lygin, V.K., Malygin, O.V., Moiseev, M.A., Khizhnyak, V.I., Karpov, V.P., Tai, E.M., Idehara, T., Mitsudo, S., Ogawa, I., Saito, T., 2007, High-power oscillator of continuous electromagnetic radiation with a frequency of 300 GHz, Radiophysics and Quantum Electronics, **50**, 420-428.
- [790] Bratman, V.L., Ginzburg, N.S., Nusinovich, G.S., Petelin, M.I., Strelkov, P.S., 1981, Relativistic gyrotrons and cyclotron autoresonance masers. Int. J. Electronics, **51**, 541-567.
- [791] Bratman, V.L., Denisov, G.G., Ofitserov, M.M., Korovin, S.D., Polevin, S.D., Rostov, V.V., 1987, Millimeter-wave HF relativistic electron oscillators. IEEE Trans. on Plasma Science, **PS-15**, 2-15.
- [792] Zaitsev, N.I., Ginzburg, N.S., Zavolskii, N.A., Zapevalov, V.E., Ilyakov, E.V., Kulagin, I.S., Kuftin, A.N., Lygin, V.K., Moiseev, M.A., Novozhilova, Yu.V., Rozental, R.M., Tsalolokhin, V.I., 2001, Highly efficient relativistic SHF gyrotron with a microsecond pulse width. Tech. Phys. Lett., **27**, 266-270.
- [793] Zaitsev, N.I., Ginzburg, S., Ilyakov, E.V., Kulagin, I.S., Lygin, V.K., Manuilov, V.N., Moiseev, M.A., Rosenthal, R.M., Zapevalov, V.E., Zavolsky, N.A., 2002, X-band high-efficiency relativistic gyrotron. IEEE Trans. on Plasma Science, **PS-30**, 840-845.
- [794] Ilyakov, E.V., Kulagin, I.S., Kuzikov, S.V., Lygin, V.K., Manuilov, V.N., Moiseev, M.A., Petelin, M.I., Rozental, R.M., Zaitsev, N.I., Zapevalov, V.E., Zavolsky, N.A., 2003, 10-MW, Ka-band gyrotron. Conf. Digest 28th Int. Conf. on Infrared and Millimeter Waves, Otsu, Japan, 325-326.
- [795] Ilyakov, E., Krasnykh, A., Kulagin, I., Kuzikov, S., Lygin, V., Moiseev, M., Petelin, M., Zaitsev, N., 2004, K_a band – 10 MW gyro-devices: an experiment and a project. 5th IEEE Int. Vacuum Electronics Conf. (IVEC 2004), Monterey, CA, USA, 61-62.
- [796] Zaitsev, N.I., Zavolsky, N.A., Zapevalov, V.E., Ilyakov, E.V., Kulagin, I.S., Lygin, V.K., Moiseev, M.A., Nechaev, V.E., Petelin, M.I., Rozental, R.M., 2003, Ten-megawatt pulsed gyrotron with a 1-cm wavelength and a 50% efficiency. Radiophysics and Quantum Electronics, **46**, 816-819.
- [797] Rozental, R.M., Zaitsev, N.I., Kulagin, I.S., Ilyakov, E.V., Ginzburg, N.S., 2004, Nonstationary Processes in an X-band relativistic gyrotron with delayed feedback. IEEE Trans. on Plasma Science, **PS-32**, 418-421.

- [798] Kremontsov, V.I., Petelin, M.I., Rabinovich, M.S., Rukhadze, A.A., Strelkov, P.S., Shkvarunets, A.G., 1978, Plasma-filled gyrotron with a relativistic supervacuum electron beam. *Sov.Phys. JETP*, **48**, 1084-1085.
- [799] Ginzburg, N.S., Kremontsov, V.I., Petelin, M.I., Strelkov, P.S., Shkvarunets, A.G., 1979, Experimental investigation on a high-current relativistic cyclotron maser. *Sov. Phys. Tech. Phys.*, **24**, 218-222.
- [800] Voronkov, S.N., Kremontsov, V.I., Strelkov, P.S., Shkvarunets, A.G., 1982, Stimulated cyclotron radiation and millimeter wavelengths from high-power relativistic electron beams. *Sov. Phys. Tech. Phys.*, **27**, 68-69.
- [801] Kolyada, Yu.E., Fainberg, Ya.B., Kornilov, E.A., Ognivenko, V.V., Kiyashko, V.A., 1976, Interaction of a high-current electron beam with a plasma in open cavity in a mirror system. *Sov. Tech. Phys. Lett.*, **2**, 348-350.
- [802] Gilgenbach, R.M., Wang, J.G., Choi, J.J., Outten, C.A., Spencer, T.A., 1988, Intense electron beam cyclotron masers with microsecond pulse lengths. *Conf. Digest 13th Int. Conf. on Infrared and Millimeter Waves, Honolulu, Hawaii, Proc., SPIE 1039*, 362-363.
- [803] Gilgenbach, R.M., Hochman, J.M., Jaynes, R., Walter, M.T., Rintamaki, J., Lash, J.S., Luginsland, J., Lau, Y.Y., Spencer, T.A., 1995, Rectangular interaction structures in high power gyrotron devices. *Conf. Digest 20th Int. Conf. on Infrared and Millimeter Waves, Lake Buena Vista (Orlando), Florida*, 528-529.
- [804] Hochman, J.M., Gilgenbach, R.M., Jaynes, R.L., Rintamaki, J.I., Lau, Y.Y., Spencer, T.A., 1997, High power microwave emission of large and small orbit rectangular cross section gyrotrons. *Conf. Digest 22nd Int. Conf. on Infrared and Millimeter Waves, Wintergreen, Virginia, USA*, 315-316.
- [805] Hochman, J.M., Gilgenbach, R.M., Jaynes, R.L., Rintamaki, J.I., Lau, Y.Y., Cohen, W.E., Peters, C.W., Spencer, T.A., 1998, Polarization control of microwave emission from high power rectangular cross-section gyrotron devices. *IEEE Trans. on Plasma Science*, **PS-26**, 383-392.
- [806] Jaynes, R.L., Gilgenbach, R.M., Cohen, W.E., Lopez, M.R., Peters, C.W., Hochman, J.M., Lau, J.J., Spencer, T.A., 1999, High power microwave production in a coaxial, large orbit, axis encircling gyrotron oscillator. *Conf. Digest 24th Int. Conf. on Infrared and Millimeter Waves, Monterey, California, USA, TU-A4*.
- [807] Jaynes, R.L., Gilgenbach, R.M., Peters, C.W., Cohen, W.E., Lopez, M.R., Lau, Y.Y., Williams, W.J., Spencer, T.A., 2000, Long-pulse, high-power, large-orbit, coaxial gyrotron oscillator experiments. *IEEE Trans. on Plasma Science*, **PS 28**, 945-952.
- [808] Gilgenbach, R.M., Jaynes, R.L., Cohen, W.E., Peters, C.W., Lopez, M.R., Lau, Y.Y., Williams, W.J., Spencer, T.A., 2000, Experiments on slotted, coaxial, high power gyrotrons. *Conf. Dig. Intense Microwave Pulses VII., Orlando, Florida, USA, SPIE-4031*, 8-18.
- [809] Granatstein, V.L., Herndon, M., Sprangle, P., Carmel, Y., Nation, J.A., 1975, Gigawatt microwave emission from an intense relativistic electron beam. *Plasma Physics*, **17**, 23-28.
- [810] Gold, S.H., Fliflet, A.W., Manheimer, W.M., McCowan, R.B., Black, W.M., Lee, R.C., Granatstein, V.L., Kinkead, A.K., Hardesty, D.L., Sucey, M., 1987, High peak power Ka-band gyrotron oscillator experiment. *Phys. Fluids*, **30**, 2226-2238.
- [811] Gold, S.H., Fliflet, A.W., Manheimer, W.M., McCowan, R.B., Lee, R.C., Granatstein, V.L., Hardesty, D.L., Kinkead, A.K., Sucey, M., 1988, High peak power Ka-band gyrotron oscillator experiments with slotted and unslotted cavities. *IEEE. Trans. Plasma Science*, **PS-16**, 142, and, Gold, S.H., 1998, private communication.
- [812] Black, W.M., Gold, S.H., Fliflet, A.W., Kirkpatrick, D.A., Manheimer, W.M., Lee, R.C., Granatstein, V.L., Hardesty, D.L., Kinkead, A.K., Sucey, M., 1990, Megavolt Multikiloamp Ka-band gyrotron oscillator experiment. *Phys. Fluids*, **B2**, 193.

- [813] Didenko, A.N., Zherlitsyn, A.G., Zelentsov, V.I., Sulakshin, A.S., Fomenko, G.P., Shtein, Yu.G., Yushkov, Yu.G., 1976, Generation of gigawatt microwave pulses in the nanosecond range. *Sov. J. Plasma Phys.*, **2**, 283-285.
- [814] Minami, K., Hayatsu, Y., Sato, T., Sanmonji, M., Granatstein, V.L., 2002, Experiment on a cold cathode gyrotron. 29th IEEE Int. Conf. on Plasma Science (ICOPS 2002), Banff, Canada, May 26-30, 3P09.
- [815] Cross, A.W., Spark, S.N., Phelps, A.D.R., 1988, Gyrotron experiments using cavities of different ohmic Q. *Conf. Digest 17th Int. Conf. on Infrared and Millimeter Waves, Pasadena, Proc., SPIE* **1929**, 392-393.
- [816] Cross, A.W., Spark, S.N., Phelps, A.D.R., 1995, Gyrotron experiments using cavities of different ohmic Q. *Int. J. Electronics*, **79**, 481-493.
- [817] Cross, A.W., MacGregor, S.J., Phelps, A.D.R., Ronald, K., Spark, S.N., Turnbull, S.M., 1995, Megawatt, 1 kHz PRF tunable gyrotron experiments. *Conf. Digest 20th Int. Conf. on Infrared and Millimeter Waves, Lake Buena Vista (Orlando), Florida*, 530-531.
- [818] Ronald, K., Cross, A.W., Phelps, A.D.R., He, W., 2001, Observations of dynamic behaviour in an electron cyclotron maser oscillator. *Appl. Phys.*, **34**, L17-L22.
- [819] Ronald, K., Phelps, A.D.R., Cross, A.W., He, W., 2001, Observations of non-stationary behaviour in electron cyclotron masers. *Proc. 9th Int. Conf. Displays and Vacuum Electronics, Garmisch-Partenkirchen, ITG-Fachbericht* **165**, 159-162.
- [820] Ronald, K., Cross, A.W., Phelps, A.D.R., He, W., Whyte, C.G., Thomson, R., Rafferty, E., 2003, ECM automodulation experiments. *Conf. Digest 28th Int. Conf. on Infrared and Millimeter Waves, Otsu, Japan*, 255-256.
- [821] Bratman, V.L., Kalynov, Yu.K., Kolganov, N.G., Manuilov, V.N., Ofitserov, M.M., Savilov, A.V., Samsonov, S.V., Volkov, A.B., 1996, Cyclotron autoresonance masers and relativistic gyrotrons. *Proc. 3rd Int. Workshop on Strong Microwaves in Plasmas, Nizhny Novgorod, 1997*, **Vol.2**, 745-761.
- [822] Bratman, V.L., Kalynov, Yu.K., Ofitserov, M.M., Samsonov, S.V., Savilov, A.V., 1997, CARMs and relativistic gyrotrons as effective sources and millimeter and submillimeter waves. *Conf. Digest 22nd Int. Conf. on Infrared and Millimeter Waves, Wintergreen, Virginia, USA*, 58-60.
- [823] Bratman, V.L., Fedotov, A.E., Kalynov, Yu.K., Manuilov, V.N., Ofitserov, M.M., Samsonov, S.V., Savilov, A.V., 1998, Gyrotron on the 5th cyclotron harmonic. *Conf. Digest 23rd Int. Conf. on Infrared and Millimeter Waves, Colchester, UK*, 325-326.
- [824] Bratman, V.L., Fedotov, A.E., Kalynov, Y.K., Manuilov, V.N., Ofitserov, M.M., Samsonov, V., Savilov, A.V., 1999, Moderately relativistic high-harmonic gyrotrons for millimeter/submillimeter wavelength band. *IEEE Trans. on Plasma Science*, **PS-27**, 456-461, and private communications, 2002.
- [825] Bratman, V.L., Dumesh, B.S., Fedotov, A.E., Manuilov, V.N., Kalynov, Yu.K., Ofitserov, M.M., Rusin, F.S., Samsonov, S.V., 2002, Powerful sources of coherent submillimeter-wave radiation. *Proc. 5th Int. Workshop on Strong Microwaves in Plasmas, Nizhny Novgorod*, ed. A.G. Litvak, Inst. of Applied Physics, Russian Academy of Sciences, Nizhny Novgorod, 2003, **Vol. 1**, 135-143.
- [826] Bratman, V.L., Dumesh, B.S., Fedotov, A.E., Grishin, Yu.A., Kalynov, Yu.K., Manuilov, V.N., Rusin, F.S., Samsonov, S.V., 2004, New sources of coherent submillimeter-wave radiation. *Conf. Digest 29th Int. Conf. on Infrared and Millimeter Waves and 12th Int. Conf. on Terahertz Electronics, Karlsruhe, Germany*, 193-194.
- [827] Bratman, V.L., Kalynov, Yu.K., Manuilov, V.N., Samsonov, S.V., 2005, Large orbit gyrotron at submillimeter waves. *Conf. Digest 30th Int. Conf. on Infrared and Millimeter Waves and 13th Int. Conf. on Terahertz Electronics, Williamsburg, VA, USA*, 443-444.

- [828] Bratman, V.L., Kalynov, Yu.K., Manuilov, V.N., Samsonov, S.V., 2005, Large-orbit gyrotron operation at submillimeter waves. Proc. 6th Int. Workshop on Strong Microwaves in Plasmas, Nizhny Novgorod, ed. A.G. Litvak, Inst. of Applied Physics, Russian Academy of Sciences, Nizhny Novgorod, 2006, **Vol. 1**, 150-155.
- [829] Bratman, V.L., Bandurkin, I.V., Dumesh, B.S., Fedotov, A.E., Kalynov, Y.K., Kolganov, N.G., Manuilov, V.N., Rusin, F.S., Samsonov, S.V., Savilov, A.V., 2005, Sources of coherent terahertz radiation. Proc. 7th Workshop on High Energy Density and High Power RF, AIP Conference Proceedings **807**, 2006, 356-366.
- [830] Hogge, J.P., Cao, H., Kasperek, W., Tran, T.M., Tran, M.Q., Paris, P.J., 1991, Ellipsoidal diffraction grating as output coupler for quasi-optical gyrotrons. Conf. Digest 16th Int. Conf. on Infrared and Millimeter Waves, Lausanne, Proc., SPIE **1576**, 540-541.
- [831] Vlasov, S.N. Koposova, E.V., Paveleyev, A.B., Khizhnyak, V.I. 1996, Gyrotrons with echelette resonators. Radiophys. and Quantum Electronics, **39**, 458-462.
- [832] Hu, W., Shapiro, M.A., Kreisler, K.E., Temkin, R.J., 1997, 140 GHz confocal cavity gyrotron experiment. Conf. Digest 22nd Int. Conf. on Infrared and Millimeter Waves, Wintergreen, Virginia, USA, 116-117.
- [833] Hu, W., Shapiro, M.A., Kreisler, K.E., Temkin, R.J., 1998, 140-GHz gyrotron experiments based on a confocal cavity. IEEE Trans. on Plasma Science, **PS-26**, 366-374.
- [834] Gapochka, M.G., Korolev, A.F., Kostienko, A.I., Sukhorukov, A.P., Sheludchenkov, A.V., Golenitski, I.I., Evtushenko, O.V., Pulino, A., 1996, Compact low-voltage quasioptical millimeter-wave generators. Proc. 25th European Microwave Conference, Prague, 144-145.
- [835] Fliflet, A.W., Hargreaves, T.A., Fischer, R.P., Manheimer, W.M., Sprangle, P., 1990, Review of quasi-optical gyrotron development. J. Fusion Energy, **9**, 31-58.
- [836] Fischer, R.P., Fliflet, A.W., Manheimer, W.M., Levush, B., Antonsen Jr., T.M., 1993, Mode priming an 85 GHz quasioptical gyrotron. Conf. Digest 18th Int. Conf. on Infrared and Millimeter Waves, Colchester (Essex, UK), Proc., SPIE **2104**, 330-331.
- [837] Bratman, V.L., Denisov, G.G., 1992, Cyclotron autoresonance masers - recent experiments and prospects. Int. J. Electronics, **72**, 969-981.
- [838] Bratman, V.L., Denisov, G.G., Ofitserov, M.M., Samsonov, S.V., Arkhipov, O.V., Kazacha, V.I., Krasnykh, A.K., Perelstein, E.A., Zamrij, A.V., 1992, Cyclotron autoresonance maser with high Doppler frequency up-conversion. Int. J. Infrared and Millimeter Waves, **13**, 1857-1873.
- [839] Bratman, V.L., Denisov, G.G., Samsonov, S.V., 1993, Cyclotron autoresonance masers: achievements and prospects of advance to the submillimeter wavelength range. Proc. 2nd Int. Workshop on Strong Microwaves in Plasmas, Moscow - Nizhny Novgorod -Moscow, Inst. of Applied Physics, Nizhny Novgorod, 1994, **Vol. 2**, 690-711.
- [840] Bratman, V.L., Denisov, G.G., Kol'chugin, B.D., Samsonov, S.V., Volkov, A.B., 1995, Experimental demonstration of high-efficiency cyclotron-autoresonance-maser operation. Phys. Rev. Lett., **75**, 3102-3105.
- [841] Ginzburg, N.S., Zotova, I.V., Sergeev, A.S., Konoplev, I.V., 1997, Experimental observation of cyclotron superradiance under group synchronism conditions. Phys. Rev. Letters, **78**, 2365-2368.
- [842] Ginzburg, N.S., Zotova, I.V., Sergeev, A.S., Phelps, A.D.R., Cross, A.W., Shapk, V.G., Yaladin, M.I., Tarakanov, V.P., 1999, Generation of ultrashort microwave pulses based on cyclotron superradiance. IEEE Trans. on Plasma Science, **PS-27**, 462-469.
- [843] Bratman, V.L., Denisov, G.G., Kalynov, Yu.K., Samsonov, S.V., Savilov, A.V., Cross, A.W., He, W., Phelps, A.D.R., Ronald, K., Whyte, C.G., Young, A.R., 1999, Novel types of cyclotron resonance devices. Proc. 4th Int. Workshop on Strong Microwaves in Plasmas, Nizhny Novgorod, ed. A.G. Litvak, Inst. of Applied Physics, Russian Academy of Sciences, Nizhny Novgorod, 2000, **Vol. 2**, 683-702.

- [844] Bratman, V.L., Fedotov, A.E., Kolganov, N.G., Samsonov, S.V., Savilov, A.V., 2000, Effective co-generation of opposite and forward waves in cyclotron-resonance masers. *Phys. Rev. Lett.*, **85**, 3424-3427.
- [845] Bratman, V.L., Fedotov, A.E., Savilov, A.V., 2000, A gyrodevice based on simultaneous excitation of opposite and forward waves (Gyrotron BWO-TWT). *IEEE Trans. on Plasma Science*, **PS-28**, 1742-1746.
- [846] Bratman, V.L., Fedotov, A.E., Kolganov, N.G., Samsonov, S.V., Savilov, A.V., 2001, Experimental study of CRM with simultaneous excitation of traveling and near-cutoff waves (CARM-Gyrotron). *IEEE Trans. on Plasma Science*, **PS-29**, 609-612.
- [847] Caplan, M., Kulke, B., Westenskow, G.A.; McDermott, D.B., Luhmann, Jr., N.C., 1992, Induction-linac-driven, millimeter-wave CARM oscillator. Laboratory Report **UCRL-53689-80**, Lawrence Livermore National Laboratory, Livermore, California.
- [848] Danly, B.G., Hartemann, F.V., Chu, T.S., Legorburn, P., Menninger, W.L., Temkin, R.J., 1992, Long-pulse millimeter-wave free-electron laser and cyclotron autoresonance maser experiments. *Phys. Fluids*, **B4**, 2307-2314.
- [849] Alberti, S., Danly, B.G., Gulotta, G., Giguet, E., Kimura, T., Menninger, W.L., Rullier, J.L., Temkin, R.J., 1993, Experimental study of a 28 GHz high-power long-pulse cyclotron autoresonance maser oscillator. *Phys. Rev. Lett.*, **71**, 2018-2021.
- [850] Wang, J.G., Gilgenbach, R.M., Choi, J.J., Outten, C.A., Spencer, T.A., 1989, Frequency-tunable, high-power microwave emission from cyclotron autoresonance maser oscillation and gyrotron interactions. *IEEE Trans. Plasma Science*, **17**, 906-908.
- [851] Choi, J.J., Gilgenbach, R.M., Spencer, T.A., 1992, Mode competition in Bragg resonator cyclotron resonance maser experiments driven by a microsecond intense electron beam. *Int. J. Electronics*, **72**, 1045-1066.
- [852] Cooke, S.J., Cross, A.W., He, W., Phelps, A.D.R., 1995, The operation of a second harmonic CARM oscillator. *Conf. Digest 20th Int. Conf. on Infrared and Millimeter Waves*, Lake Buena Vista (Orlando), Florida, 427-428.
- [853] Cooke, S.J., Cross, A.W., He, W., Phelps, A.D.R., 1996, Experimental operation of a cyclotron autoresonance maser oscillator at the second harmonic. *Phys. Rev. Lett.*, **77**, 4836-4839.
- [854] Young, A.R., He, W., Ronald, K., Cross, A.W., Whyte, C.G., Phelps, A.D.R., 1998, Cold and thermionic cathode CARM experiments. *Conf. Digest 23rd Int. Conf. on Infrared and Millimeter Waves*, Colchester, UK, 448-449.
- [855] Felch, K., James, B.G., Borchard, P., Cahalan, P., Chu, T.S., Hargreaves, T.A., Blank, M., Pershing, D.E., Calame, J.P., Nguyen, K., Danly, B.G., Levush, B., 1999, Recent test results for a 10 kW average power W-band gyrokystron amplifier. *Conf. Digest 24th Int. Conf. on Infrared and Millimeter Waves*, Monterey, California, USA, M-A5.
- [856] Blank, M., Danly, G., Levush, B., Calame, J.P., Nguyen, K., Pershing, D., Petillo, J., Hargreaves, T.A., True, R.B., Theiss, J., Good, G.R., Felch, K., James, B.G., Borchard, P., Cahalan, P., Chu, T.S., Jory, H., Lawson, W.G., Antonsen, Jr., T.M., 1999, Demonstration of a 10 kW average power 94 GHz gyrokystron amplifier. *Phys. of Plasmas*, **6**, 4405-4409.
- [857] Blank, M., Felch, K., James, B.G., Borchard, P., Cahalan, P., Chu, T.S., Jory, H., Hargreaves, T.A., True, R.B., Theiss, A.J., Good, G.R., Danly, B.G., Levush, B., Calame, J.P., Nguyen, K., Pershing, D., Petillo, J., Lawson, W.G., Antonsen, T.M. jr., 1999, Experimental demonstration of a high-average power W-band gyrokystron amplifier. *Proc. 4th Int. Workshop on Strong Microwaves in Plasmas*, Nizhny Novgorod, ed. A.G. Litvak, Inst. of Applied Physics, Russian Academy of Sciences, Nizhny Novgorod, 2000, **Vol. 2**, 703-712.

- [858] Blank, M., Felch, K., James, B.G., Borchard, P., Cahalan, P., Chu, T.S., Danly, B.G., Pershing, D.E., Nguyen, K., Calame, J.P., Levush, B., 2000, Demonstration of high average power W-band gyro-amplifiers. Conf. Digest 25th Int. Conf. on Infrared and Millimeter Waves, Beijing, P.R. China, 113-114.
- [859] Blank, M., Danly, B.G., Levush, B., 2000, Experimental demonstration of W-band gyro-klystron amplifiers with improved gain and efficiency. IEEE Trans. on Plasma Science, **PS-28**, 706-711.
- [860] Blank, M., Felch, K., James, B.G., Borchard, P., Cahalan, P., Chu, T.S., Jory, H., Danly, B.G., Levush, B., Calame, J.P., Nguyen, K.T., Pershing, D.E., 2002, Development and demonstration of high-average power W-band gyro-amplifiers for radar applications. IEEE Trans. on Plasma Science, **PS-30**, 865-875.
- [861] Danly, B.G., Blank, M., Calame, J.P., Levush, B., Nguyen, K.T., Pershing, D.E., Parker, R.K., Felch, K.L., James, B.G., Borchard, P., Cahalan, P., Chu, T.S., Jory, H.R., Hargreaves, T.A., True, R.B., Lawson, W.G., Antonsen, T.M., 2000, Development and testing of a high-average power, 94-GHz gyro-klystron. IEEE Trans. on Plasma Science, **PS-28**, 713-726.
- [862] Blank, M., Borchard, P., Cauffman, S., Felch, F., 2006, Broadband W-band gyrotron amplifier development. Conf. Digest 31st Int. Conf. on Infrared and Millimeter Waves and 14th Int. Conf. on Terahertz Electronics, Shanghai, China, 198.
- [863] Antakov, I.I., Zasyrkin, E.V., Sokolov, E.V., Yulpatov, V.K., Keyer, A.P., Musatov, V.S., Myasnikov, V.E., 1993, 35 GHz radar gyro-klystrons. Conf. Digest 18th Int. Conf. on Infrared and Millimeter Waves, Colchester (Essex, UK), Proc., SPIE **2104**, 338-339.
- [864] Antakov, I.I., Gaponov, A.V., Zasyrkin, E.V., Sokolov, E.V., Yulpatov, V.K., Aksenova, L.A., Keyer, A.P., Musatov, V.S., Myasnikov, V.E., Popov, L.G., Levitan, B.A., Tolkachev, A.A., 1993, Gyro-klystrons: millimeter wave amplifiers of the highest power. Proc. 2nd Int. Workshop on Strong Microwaves in Plasmas, Moscow - Nizhny Novgorod - Moscow, ed. A.G. Litvak, Inst. of Applied Physics, Nizhny Novgorod, 1994, **Vol. 2**, 587-596.
- [865] Antakov, I.I., Aksenova, L.A., Zasyrkin, E.V., Moiseev, M.A., Popov, L.G., Sokolov, E.V., Yulpatov, V.K., 1990, Multicavity phase-locked gyrotrons for lower-hybrid heating in toroidal plasmas. Proc. Int. Workshop on Strong Microwaves in Plasmas, Suzdal, Inst. of Applied Physics, Nizhny Novgorod, 1991, 773-782.
- [866] Antakov, I.I., Moiseev, M.A., Sokolov, E.V., Zasyrkin, E.V., 1993, Theoretical and experimental investigation of X-band two-cavity gyro-klystron. Conf. Digest 18th Int. Conf. on Infrared and Millimeter Waves, Colchester (Essex, UK), Proc., SPIE **2104**, 336-337.
- [867] Antakov, I.I., Moiseev, M.A., Sokolov, E.V., Zasyrkin, E.V., 1994, Theoretical and experimental investigation of X-band two-cavity gyro-klystron. Int. J. of Infrared and Millimeter Waves, **15**, 873-887.
- [868] Zasyrkin, E.V., Moiseev, M.A., Sokolov, E.V., Yulpatov, V.K., 1995, Effect of penultimate cavity position and tuning on three-cavity gyro-klystron amplifier performance. Int. J. Electronics, **78**, 423-433.
- [869] Zasyrkin, E.V., Moiseev, M.A., Gachev, I.G., Antakov, I.I., 1996, Study of high-power Ka-band second-harmonic gyro-klystron amplifier. IEEE Trans. on Plasma Science, **PS-24**, 666-670.
- [870] Antakov, I.I., Gachev, I.G., Sokolov, E.V., 1995, Experimental study of two-cavity gyrotron with feedback between cavities. Proc. Conf.: Intense Microwave-Pulses III, San Diego, Proc. SPIE **2557**, 380-385.
- [871] Antakov, I.I., Zasyrkin, E.V., Sokolov, E.V., 1993, Design and performance of 94 GHz high power multicavity gyro-klystron amplifier. Conf. Digest 18th Int. Conf. on Infrared and Millimeter Waves, Colchester (Essex, UK), Proc., SPIE **2104**, 466-467 and Proc. 2nd Int. Workshop on Strong Microwaves in Plasmas, Moscow - Nizhny Novgorod - Moscow, ed. A.G. Litvak, Inst. of Applied Physics, Nizhny Novgorod, 1994, **Vol. 2**, 754-758.

- [872] Zasyupkin, E.V., Gachev, I.G., Antakov, I.I., Moiseev, M.A., Lygin, V.K., Sokolov, E.V., 1998, Development of a W-band 120 kW gyrokystron at IAP. Conf. Digest 23rd Int. Conf. on Infrared and Millimeter Waves, Colchester, UK, 183.
- [873] Zasyupkin, E.V., Gachev, I.G., Antakov, I.I., Moiseev, M.A., Zavolsky, N.A., 1999, Study of a W-band pulsed 200 kW gyrokystron amplifier. Conf. Digest 24th Int. Conf. on Infrared and Millimeter Waves, Monterey, California, USA, W-A2.
- [874] Gachev, I.G., Antakov, I.I., Moiseev, M.A., Sokolov, E.V., Zavolsky, N.A., Zasyupkin, E.V., 1999, 200 kW pulsed W-band gyrokystron amplifier. Proc. 4th Int. Workshop on Strong Microwaves in Plasmas, Nizhny Novgorod, ed. A.G. Litvak, Inst. of Applied Physics, Russian Academy of Sciences, Nizhny Novgorod, 2000, **Vol. 2**, 713-717.
- [875] Gachev, I.G., Antakov, I.I., Zasyupkin, E.V., 2000, Status of a W-band pulsed 200 kW gyrokystron experiment. Conf. Digest 25th Int. Conf. on Infrared and Millimeter Waves, Beijing, P.R. China, 181-182.
- [876] Zasyupkin, E.V., Gachev, I.G., Antakov, I.I., Sokolov, E.V., 2001, W-band pulsed 300 kW gyrokystron amplifier. Conf. Digest, 26th Int. Conf. on Infrared and Millimeter Waves, Toulouse, France, 5-89-5-91.
- [877] Gachev, I.G., Antakov, I.I., Lygin, V.K., Moiseev, M.A., Sokolov, E.V., Zasyupkin, E.V., 2002, A Ka-Band second harmonic gyrokystron with a permanent magnet. Proc. 5th Int. Workshop on Strong Microwaves in Plasmas, Nizhny Novgorod, ed. A.G. Litvak, Inst. of Applied Physics, Russian Academy of Sciences, Nizhny Novgorod, 2003, **Vol. 1**, 151-155.
- [878] Liu, P.K., Zhang, S.C., Xu, S.X., Su, Y.N., Quin, W.Z., Jin, F., Gu, W., Yue, Q.Z., Geng, Z.H., 2007, Recent results in the development of a Ka-band second harmonic gyrokystron amplifier, Proc. 8th IEEE Int. Vacuum Electronics Conference (IVEC 2007), Kitakyushu, Japan, 237-238 and Liu, P.K., IECAS Beijing, private communication.
- [879] Liu, P.-K., Zhang, S.C., Xu, S.X., Su, Y.N., Qin, W.Z., Geng, Z.H., Gu, W., Xue, Q.Z., Jin, F., Han, B., 2010, Experimental studies of a Ka-band second harmonic gyrokystron amplifier, Proc. 35th Int. Conf. on Infrared, Millimeter and Terahertz Waves, Rome, Italy, Mo-E3.2.
- [880] Xu, S.X., Liu, P.K., Zhang, S., Su, Y., Geng, Z.H., Gu, W., Xue, Q., Han, B., 2012, A Ka-band second harmonic gyrokystron amplifier. IEEE Trans. on Plasma science, **40**, 2099-2104.
- [881] Choi, J.J., Kim, H.J., Na, Y.H., Kim, W.C., Kwon, M., Temkin, R., 2002, Initial hot-tests on a 28 GHz five-cavity gyrokystron amplifier. Proc. 3rd IEEE Int. Vacuum Electronics Conf. (IVEC 2002), Monterey, USA, 367-368.
- [882] Choi, J.J., McCurdy, A.H., Wood, F., Kyser, Calame, J., Nguyen, K., Danly, B.G., Levush, B., Parker, R.K., 1997, High power 35 GHz gyrokystron amplifiers. Conf. Digest 22nd Int. Conf. on Infrared and Millimeter Waves, Wintergreen, Virginia, USA, 229-230.
- [883] Choi, J.J., McCurdy, A.H., Wood, F.N., Kyser, R.H., Calame, J.P., Nguyen, K.T., Danly, B.G., Antonsen, T.M., Levush, B., Parker, R.K., 1998, Experimental investigation of a high power, two-cavity, 35 GHz gyrokystron amplifier. IEEE Trans. on Plasma Science, **PS-26**, 416-425.
- [884] Garven, M., Calame, J.P., Choi, J.J., Danly, B.G., Nguyen, K.T., Wood, F., 1998, Experimental 35 GHz multi-cavity gyrokystron amplifiers. Conf. Digest 23rd Int. Conf. on Infrared and Millimeter Waves, Colchester, UK, 28-29.
- [885] Garven, M., Calame, J.P., Danly, B.G., Levush, B., Nguyen, K.T., Wood, F.N., 1999, Experimental studies of a high gain 35 GHz gyrokystron amplifier. Conf. Digest 24th Int. Conf. on Infrared and Millimeter Waves, Monterey, California, USA, M-A6.
- [886] Calame, J.P., Graven, M., Choi, J.J., Nguyen, K., Wood, F., Blank, M., Danly, B.G., Levush, B., 1999, Experimental studies of bandwidth and power production in a three-cavity 35 GHz gyrokystron amplifier. Phys. of Plasmas, **6**, 285-297.

- [887] Garven, M., Calame, J.P., Nguyen, K.T., Danly, B.G., Levush, B., Wood, F.N., 2000, Experimental studies of a four-cavity, 35 GHz gyrokystron amplifier. *IEEE Trans. on Plasma Science*, **PS-28**, 672-680.
- [888] Blank, M., Danly, B.G., Levush, B., Latham, P.E., Pershing, D.E., 1997, Experimental demonstration of a W-band gyrokystron amplifier. *Phys. Rev. Lett.*, **79**, 4485-4488.
- [889] Blank, M., Danly, B.G., Levush, B., Pershing, D.E., 1998, Experimental investigation of W-band (93 GHz) gyrokystron amplifiers. *IEEE Trans. on Plasma Science*, **PS-26**, 409-415.
- [890] Blank, M., Danly, B.G., Levush, B., 1998, Experimental demonstration of W-band gyroamplifiers with improved performance. *Conf. Digest 23rd Int. Conf. on Infrared and Millimeter Waves*, Colchester, UK, 26-27.
- [891] Danly, B.G., Blank, M., Calame, J.P., Levush, B., Nguyen, K., Pershing, D., Petillo, J., Hargreaves, T.A., True, R.B., Theiss, A.J., Good, G.R., Felch, K., Chu, T.S., Jory, H., Borchard, P., James, B.G., Lawson, W.G., Antonsen, T.M., 1998, Development of a W-band gyrokystron for radar applications. *Conf. Digest 23rd Int. Conf. on Infrared and Millimeter Waves*, Colchester, UK, 32-33.
- [892] Burke, J.M., Czarnaski, M.A., Fischer, R.P., Giangrave, M., Fliflet, A.W., Manheimer, W.M., 1991, 85 GHz TE₁₃ phase-locked gyrokystron oscillator experiment. *Conf. Digest 13th Int. Conf. on Infrared and Millimeter Waves*, Honolulu, Hawaii, Proc., SPIE **1039**, 228-229.
- [893] Fischer, R.P., Fliflet, A.W., Manheimer, W.M., 1992, The NRL 85 GHz quasioptical gyrokystron experiment. *Conf. Digest 17th Int. Conf. on Infrared and Millimeter Waves*, Pasadena, Proc., SPIE **1039**, 254-255.
- [894] Li, H., UESTC, Chengdu, China, private communication.
- [895] Ilyakov, E.V., Kulagin, I.S., Kuzikov, S.V., Moiseev, M.A., Petelin, M.I., Rozental, R.M., Zaitsev, N.I., Zavolsky, N.A., 2004, Ka-band gyrokystron operating at a combination of high-order modes. *Proc. 15th Int. Conf. on High-Power Particle Beams (BEAMS'2004)*, St. Petersburg, Russia, 525-527.
- [896] Ilyakov, E.V., Kulagin, I.S., Kuzikov, S.V., Moiseev, M.A., Petelin, M.I., Shevchenko, A.S., Zaitsev, N.I., 2005, Gyrokystron operating at a sequence of high-order modes. *Proc. 6th Int. Workshop on Strong Microwaves in Plasmas*, Nizhny Novgorod, ed. A.G. Litvak, Inst. of Applied Physics, Russian Academy of Sciences, Nizhny Novgorod, 2006, **Vol. 1**, 58-61.
- [897] Zaitsev, N.I., Ilyakov, E.V., Kuzikov, S.V., Kulagin, I.S., Lygin, V.K., Moiseev, M.A., Petelin, M.I., Shevchenko, A.S., 2005, Pulsed high-order volume mode gyrokystron. *Radiophysics and Quantum Electronics*, **48**, 737-740.
- [898] Zaitsev, N.I., Kulagin, I.S., Kuzikov, S.V., Plotkin, M.E., Syratcev, I., 2007, Microwave components for 30 GHz high-power gyrokystron. *Conf. Digest 32nd Int. Conf. on Infrared and Millimeter Waves and 15th Int. Conf. on Terahertz Electronics*, Cardiff, UK, 369-370.
- [899] Petelin, M., Danilov, Y., Pavelyev, V., Zasytkin, E., Zaitsev, N., 2010, A research to a high-order-mode gyrokystron, *Proc. 11th IEEE Int. Vacuum Electronics Conference (IVEC 2010)*, Monterey, USA, pp. 191-192.
- [900] Zaitsev, N.I., Danilov, Yu.Yu., Gvozdev, A.K., Kuzikov, S.V., Moiseev, M.A., Petelin, M.I., Plotkin, M.E., Zapevalov, S.A., 2011, A pulsed multimewatt gyrokystron, *Proc. 8th Int. Workshop Strong Microwaves and Terahertz Waves: Sources and Applications*, Nizhny Novgorod – St. Petersburg, Russia, July 9-16, 2011, p. 140.
- [901] Tantawi, S.G., Main, W.T., Latham, P.E., Nusinovich, G.S., Lawson, W.G., Striffler, C.D., Granatstein, V.L., 1992, High-power X-band amplification from an overmoded three-cavity gyrokystron with a tunable penultimate cavity. *IEEE Trans. Plasma Science*, **PS-20**, 205-215.
- [902] Lawson, W., Calame, J.P., Hogan, P., Skopec, M., Striffler, C.D., Granatstein, V.L., 1992, Performance characteristics of a high-power X-band two-cavity gyrokystron. *IEEE Trans. Plasma Science*, **PS-20**, 216-223.

- [903] Matthews, H.W., Lawson, W., Calame, J.P., Flaherty, M.K.E., Hogan, B., Cheng, J., Latham, P.E., 1994, Experimental studies of stability and amplification in a two-cavity second harmonic gyrokystron. *IEEE Trans. Plasma Science*, **PS-22**, 825-833.
- [904] Lawson, W., Hogan, B., Calame, J.P., Cheng, J., Latham, P.E., Granatstein, V.L., 1994, Experimental studies of 30 MW fundamental mode and harmonic gyro-amplifiers. *Conf. Digest 19th Int. Conf. on Infrared and Millimeter Waves, Sendai, JSAP Catalog No.: AP 941228*, 421-422.
- [905] Park, G.-S., Granatstein, V.L., Park, S.Y., Armstrong, C.M., Ganguly, A.K., 1992, Experimental study of efficiency optimization in a three-cavity gyrokystron amplifier. *IEEE Trans. on Plasma Science*, **PS-20**, 224-231.
- [906] Lawson, W., Hogan, B., Flaherty, M.K.E., Metz, H., 1996, Design and operation of a two-cavity third harmonic Ka-band gyrokystron. *Appl. Phys. Lett.*, **63**, 1849-1851.
- [907] Lawson, W., Cheng, J., Calame, J.P., Castle, M., Hogan, B., Granatstein, V.L., Reiser, M., Saraph, G.P., 1998, High power operation of a three-cavity X-band coaxial gyrokystron. *Phys. Rev.Lett.*, **81**, 3030-3033.
- [908] Lawson, W., Cheng, J., Hogan, B., Granatstein, V.L., Xu, X., 1998, High power operation of an 8.6 GHz coaxial gyrokystron. *Conf. Digest 23rd Int. Conf. on Infrared and Millimeter Waves, Colchester, UK*, 373-374.
- [909] Cheng, J., Xu, X., Lawson, J., Calame, J.P., Castle, M., Hogan, B.P., Granatstein, V.L., Nusinovich, G.S., Reiser, M., 1999, Experimental studies of a high-power, X-band, coaxial gyrokystron. *IEEE Trans. on Plasma Science*, **PS-27**, 1175-1187.
- [910] Lawson, W., Hogan, B., Gouveia, S., Huebschman, B., Granatstein, V.L., 2002, Development of Ku-band frequency-doubling coaxial gyrokystrons for accelerator applications. *Proc. 3rd IEEE Int. Vacuum Electronics Conf. (IVEC 2002), Monterey, USA*, 1-82.
- [911] Lawson, W., Hogan, B., Gouveia, E.S., Hübschman, B., Granatstein, V.L., 2002, Improved of a frequency doubling Ku-band gyrokystron experiment. *Proc. 27th Int. Conf. on Infrared and Millimeter Waves, San Diego, USA*, 203-204.
- [912] Lawson, W., Gouveia, S., Hogan, B., Granatstein, V.L., 2003, Experimental results of four-cavity 17 GHz gyrokystron. *4th IEEE Int. Vacuum Electronics Conf. (IVEC 2003), Seoul, Korea*, 344-345.
- [913] Gouveia, E.S., Lawson, W., Hogan, B., Bharathan, K., Granatstein, V.L., 2003, Current status of gyrokystron research at the University of Maryland. *Proc. 6th Workshop of High Energy Density and High Power, Berkeley Springs, West Virginia*, 79-88.
- [914] Liu, B., Wang, E., Qian, L., Li, Z., Feng, J., 2010, Experimental study of a Ka band gyro-TWT with the mode-selective circuits, *J. Infrared Milli Terahz Waves*, **31**, 1463-1468.
- [915] Liu, B., Wang, E.F., Qian, L.J., Li, Z.I., Feng, J.J., Experimental study of a Ka band gyro-TWT with the mode-selective circuits, *Proc. 35th Int. Conf. on Infrared, Millimeter and Terahertz Waves, Rome, Italy*, Mo-E3.4.
- [916] Liu, B., Feng, J., Wang, E., Li, Z., Zeng, X., Qian, L., Wang, H., 2011, Design and experimental study of a Ka-band gyro-TWT with periodic dielectric loaded circuits, *IEEE Trans. on Plasma Science*, **39**, 1665-1672.
- [917] Wang, E.F., Zeng, X., Liu, B.T., Li, Z.L., Feng, J.J., 2012, Experimental study of 290 kW Ka-band gyrotron-traveling wave-tube, *Proc. 13th IEEE Int. Vacuum Electronics Conference and 9th IEEE Int. Vacuum Electron Sources Conference (IVEC-IVESC 2012), Monterey, CA, USA*, pp. 215-216.
- [918] Ferguson, E., Symons, R.S., 1981, A gyro-TWT with a space-charged limited gun. *Proc. Int. Electron Device Meeting*, 198-201.
- [919] Eckstein, J.N., Latshaw, D.W., Stone, D.S., 1983, 95 GHz gyro traveling wave tube. *VARIAN Assoc., Final Rep. Contract DASG60-79-C-005 MOD P003 (BMDACTC)*, and Bohlen, H.P., Felch, K., 1996, private communication, CPI, Palo Alto.

- [920] Blank, M., Borchard, P., Cauffman, S., Felch, K., 2005, Development and demonstration of a broadband W-band gyro-TWT amplifier. Conf. Digest 30th Int. Conf. on Infrared and Millimeter Waves and 13th Int. Conf. on Terahertz Electronics, Williamsburg, VA, USA, 652-653.
- [921] Blank, M., Borchard, P., Cauffman, S., Felch, K., 2006, Demonstration of a broadband W-band gyro-TWT amplifier. Proc. Int. Vacuum Electronics Conference and Int. Vacuum Electron Sources (IVEC/IVESC 2006), Monterey, California, USA, 459-460.
- [922] Duffield, M.J., North, R., 2011, Manufacture and evaluation of a GyroTWA amplifier. Proc. 12th IEEE Int. Vacuum Electronics Conference (IVEC 2011), Bangalore, India, 17.1, pp. 333.
- [923] Bratman, V.L., Cross, A.W., Denisov, G.G., He, W., Phelps, A.D.R., Ronald, K., Samsonov, S.V., Whyte, C.G., Young, A.R., 2000, Efficient wide-band gyro-TWT with a helically grooved waveguide. Conf. Digest 25th Int. Conf. on Infrared and Millimeter Waves, Beijing, P.R. China, 175-176.
- [924] Denisov, G.G., 2001, Development of frequency-tunable high-power gyro-devices. Conf. Digest, 26th Int. Conf. on Infrared and Millimeter Waves, Toulouse, France, 5-42-5-47.
- [925] Denisov, G.G., Bratman, V.L., Manuilov, V.N., Kalynova, G.I., Ofitserov, M.M., Samsonov, S.V., Volkov, A.B., 2002, New test results on broad-band gyro-TWT and gyro-BWO with helically grooved operating waveguides. Proc. 27th Int. Conf. on Infrared and Millimeter Waves, San Diego, USA, 197-198.
- [926] Bratman, V.L., Denisov, G.G., Kalynova, G.I., Manuilov, V.N., Ofitserov, M.M., Samsonov, S.V., Volkov, A.B., 2002, Broadband efficient low-relativistic gyro-TWT with helically grooved waveguide. Proc. 3rd IEEE Int. Vacuum Electronics Conf. (IVEC 2002), Monterey, USA, 359-360.
- [927] Samsonov, S.V., Bogdashov, A.A., Denisov, G.G., Ereemeev, A.G., Gachev, I.G., Holoptsev, V.V., Ivanov, V.Yu., Kalynova, G.I., Kornishin, S.Yu., Kurkin, V.S., Manuilov, V.N., Maslov, V.V., Mishakin, S.V., Plotnikov, I.V., Smirnova, T.M., 2011, Development of helical-waveguide gyro-TWT at IAP, Proc. 8th Int. Workshop Strong Microwaves and Terahertz Waves: Sources and Applications, Nizhny Novgorod – St. Petersburg, Russia, July 9-16, 2011, pp. 123-124.
- [928] Bratman, V.L., Cross, A.W., Denisov, G.G., Glyavin, M.Yu., He, W., Luchinin, A.G., Lygin, V.K., Manuilov, V.N., Phelps, A.D.R., Samsonov, S.V., Thumm, M., Volkov, A.B., 2002, Broadband gyro-TWTs and gyro-BWOs with helically rippled waveguides. Proc. 5th Int. Workshop on Strong Microwaves in Plasmas, Nizhny Novgorod, ed. A.G. Litvak, Inst. of Applied Physics, Russian Academy of Sciences, Nizhny Novgorod, 2003, **Vol. 1**, 46-57.
- [929] Denisov, G.G., Bratman, V.L., Glyavin, M.Yu., Lygin, V.K., Luchinin, A.G., Manuilov, V.N., Ofitserov, M.M., Samsonov, S.V., Thumm, M., Volkov, A.B., 2003, Recent test results on broad-band gyro-TWT and gyro-BWO with helically grooved operating waveguides. 4th IEEE Int. Vacuum Electronics Conf. (IVEC 2003), Seoul, Korea, 338-339.
- [930] Bratman, V.L., Denisov, G.G., Samsonov, S.V., Cross, A.W., Phelps, A.D.R., He, W., 2007, High-efficiency wideband gyro-TWTs and gyro-BWOs with helically corrugated waveguides, Radiophysics and Quantum Electronics, **50**, 95-107.
- [931] Samsonov, S.V., Bratman, V.L., Denisov, G.G., Gachev, I.G., Glyavin, M.Yu., Manuilov, V.N., 2007, Gyro-TWTs and gyro-BWOs with helically corrugated waveguides. Conf. Digest 32nd Int. Conf. on Infrared and Millimeter Waves and 15th Int. Conf. on Terahertz Electronics, Cardiff, UK, 578-580.
- [932] Samsonov, S.V., Denisov, G.G., Gachev, I.G., Kalynova, G.I., Manuilov, V.N., Mishakin, S.V., Bykov, Yu.V., Ereemeev, A.G., Holoptsev, V.V., 2009, Development of helical-waveguide gyro-TWT and gyro-BWO, Proc. 34th Int. Conf. on Infrared, Millimeter and Terahertz Waves, Busan, Korea, M3D03.0269.

- [933] Samsonov, S.V., Denisov, G.G., Gachev, I.G., Ereemeev, A.G., Fiks, A.S., Kholoptsev, V.V., Kalynova, G.I., Manuilov, V.N., Mishakin, S.V., Sokolov, E.V., 2012, CW Ka-band kilowatt-level helical-waveguide Gyro-TWT. *IEEE Trans. on Electron Devices*, **59**, 2250-2255.
- [934] Xue, Q.Z., Du, C.H., Liu, P.K., Zhang, S.C., Liu, P.K., Gu, W., Su, Y.L., Xu, S.X., Geng, Z.H., Wang, S.J., 2012, Research Progress of Ka band gyro-TWTs in IECAS, *Proc. 13th IEEE Int. Vacuum Electronics Conference and 9th IEEE Int. Vacuum Electron Sources Conference (IVEC-IVESC 2012)*, Monterey, CA, USA, p. 421.
- [935] Sirigiri, J.R., Shapiro, M.A., Temkin, R.J., 2002, Initial experimental results from the MIT 140 GHz quasioptical gyro-TWT. *Proc. 3rd IEEE Int. Vacuum Electronics Conf. (IVEC 2002)*, Monterey, USA, 83-84.
- [936] Sirigiri, J.R., Shapiro, M.A., Temkin, R.J., 2002, Experimental results from the MIT 140 GHz quasioptical Gyro-TWT, *Proc. 27th Int. Conf. on Infrared and Millimeter Waves*, San Diego, USA, 235-236.
- [937] Sirigiri, J.R., Shapiro, M.A., Temkin, R.J., 2003, A novel 140 GHz quasioptical gyro-TWT. *Conf. Digest 28th Int. Conf. on Infrared and Millimeter Waves*, Otsu, Japan, 207-208.
- [938] Joye, C.D., Shapiro, M.A., Sirigiri, J.R., Temkin, R.J., Torrezan, A.C., 2008, Operation of a wideband 140 GHz, 1 kW confocal gyro-traveling wave amplifier, *Proc. 9th IEEE Int. Vacuum Electronics Conference (IVEC 2008)*, Monterey, CA, USA, 89-90.
- [939] Joye, C.D., Shapiro, M.A., Sirigiri, J.R., Temkin, R.J., 2008, A wideband 140 GHz, 1 kW, confocal gyro-traveling wave amplifier, *Proc. 33rd Int. Conf. on Infrared, Millimeter and Terahertz Waves*, Pasadena, CA, USA, F2A2.1347.
- [940] Kim, H., Joye, C.D., Shapiro, M.A., Sirigiri, J.R., Temkin, R.J., Woskov, P.P., Maly, T., Griffin, R.G., 2009, An overmoded 140 GHz, 1 kW quasioptical gyro-TWT with an internal mode converter, *Proc. 34th Int. Conf. on Infrared, Millimeter and Terahertz Waves*, Busan, Korea, T5E50.0072.
- [941] Joye, C.D., Shapiro, M.A., Sirigiri, J.R., Temkin, R.J., 2009, Demonstration of a 140-GHz 1-kW confocal gyro-traveling-wave amplifier, *IEEE Trans. on Electron Devices*, **56**, 818-827.
- [942] Kim, H.J., Nanni, E.A., Shapiro, M.A., Sirigiri, J.R., Woskov, P.P., Temkin, R.J., 2010, Amplification of picosecond pulses in a 140-GHz gyrotron-traveling wave tube, *Physical Review Letter*, **105**, 135101-1 135101-4.
- [943] Kim, H., Nanni, E.A., Shapiro, M.A., Sirigiri, J.R., Temkin, R.J., Woskov, P.P., 2010, Experimental measurement of picosecond pulse amplification in a 140 GHz gyro-TWT, *Proc. 11th IEEE Int. Vacuum Electronics Conference (IVEC 2010)*, Monterey, USA, pp. 193-194.
- [944] Nanni, E.A., Kim, H.J., Shapiro, M.A., Woskov, P.P., Temkin, R.J., 2010, Amplification of picosecond pulses in a 140 GHz gyro-TWT, *Proc. 35th Int. Conf. on Infrared, Millimeter and Terahertz Waves*, Rome, Italy, Tu-E3.2.
- [945] Park, G.S., Park, S.Y., Kyser, R.H., Armstrong, C.M., Ganguly, A.K., Parker, R.K., 1994, Broadband operation of a Ka-band tapered gyro-traveling wave amplifier. *IEEE Trans. Plasma Science*, **PS-22**, 536-543.
- [946] Park, G.S., Choi, J.J., Park, S.J., Armstrong, C.M., Ganguly, A.K., Kyser, R.H., Parker, R.K., 1995, Gain broadening of two-stage tapered gyrotron traveling wave tube amplifier. *Phys.Rev.Lett.*, **74**, 2399-2402.
- [947] Choi, J.J., Park, G.S., Ganguly, A.K., Armstrong, C.M., Calise, F., Wood, F., Sobocinski, B., Parker, R.K., 1995, Experimental investigation on broadband millimeter wave gyro-TWT amplifiers. *Conf. Digest 20th Int. Conf. on Infrared and Millimeter Waves*, Lake Buena Vista (Orlando), Florida, 343-344.
- [948] Garven, M., Calame, J.P., Danly, B.G., Nguyen, K.T., Levush, B., Wood, F.N., Pershing, D.E., 2002, A gyrotron-traveling-wave tube amplifier experiment with a ceramic loaded interaction region. *IEEE Trans. on Plasma Science*, **PS-30**, 885-893.

- [949] Garven, M., Calame, J.P., Danly, G., Nguyen, K.T., Levush, B., Wood, F.N., 2002, Experimental studies of a Gyro-TWT amplifier with a lossy ceramic interaction region. 29th IEEE Int. Conf. on Plasma Science (ICOPS 2002), Banff, Canada, May 26-30, 2B0607.
- [950] Calame, J.P., Garven, M., Danly, B.G., Levush, B., Nguyen, K.T., 2003, Gyrotron-traveling wave-tube circuits based on lossy ceramics. IEEE Trans. on Electron Devices, **ED-49**, 1469-1477.
- [951] Pershing, D.E., Nguyen, K.T., Calame, J.P., Danly, B.G., Levush, B., Wood, F.N., Garven, M., 2004, A TE_{11} K_a -band gyro-TWT amplifier with high-average power compatible distributed loss. IEEE Trans. on Plasma Science, **PS-32**, 947-956.
- [952] Leou, K.C., McDermott, D.B., Luhmann, Jr., N.C., 1992, Design of experimental dielectric loaded wideband Gyro-TWT. Conf. Digest 17th Conf. on Infrared and Millimeter Waves, Pasadena, Proc., SPIE **1929**, 326-327.
- [953] Leou, K.C., Wang, Q.S., Chong, C.K., Balkcum, A.J., Fochs, S.N., Garland, E.S., Pretterebner, J., Lin, A.T., McDermott, D.B., Hartemann, F., Luhmann, Jr., N.C., 1993, Gyro-TWT amplifiers at UCLA. Conf. Digest 18th Int. Conf. on Infrared and Millimeter Waves, Colchester (Essex, UK), Proc., SPIE **2104**, 531-532.
- [954] Wang, Q.S., Leou, K.C., Chong, C.K., Balkeum, A.J., McDermott, D.B., Luhmann, Jr., N.C., 1994, Gyro-TWT amplifier development at UCD. Conf. Digest 19th Int. Conf. on Infrared and Millimeter Waves, Sendai, JSAP Catalog No.: **AP 941228**, 415-416.
- [955] Wang, Q.S., McDermott, D.B., Luhmann, Jr., N.C., 1995, Stable operation of a 200 kW second harmonic TE_{21} gyro-TWT amplifier. Conf. Digest 20th Int. Conf. on Infrared and Millimeter Waves, Lake Buena Vista (Orlando), Florida, 347-348.
- [956] Wang, Q.S., McDermott, D.B., Luhmann, Jr., N.C., 1995, Demonstration of marginal stability by a 200 kW second-harmonic gyro-TWT amplifier. Phys. Rev. Lett. **75**, 4322-4325.
- [957] Wang, Q.S., McDermott, D.B., Luhmann, Jr., N.C., 1996, Operation of a stable 200-kW second-harmonic gyro-TWT amplifier. IEEE Trans. on Plasma Science, **PS-24**, 700-706.
- [958] Leou, K.C., McDermott, D.B., Luhmann, Jr., N.C., 1996, Large-signal characteristics of a wide-band dielectric-loaded gyro-TWT amplifier. IEEE Trans. on Plasma Science, **PS-24**, 718-726.
- [959] Furano, D.S., McDermott, D.B., Kou, C.S., Luhman, Jr., N.C., Vitello, P., 1989, Theoretical and experimental investigation of a high-harmonic gyro-TWT amplifier. Phys. Rev. Lett., **62**, 1314-1317.
- [960] Chong, C.K., McDermott, D.B., Luhmann, Jr., N.C., 1998, Large-signal operation of a third-harmonic slotted gyro-TWT amplifier. IEEE Trans. on Plasma Science, **PS-26**, 500-507.
- [961] Song, H.H., Barnett, L.R., McDermott, D.B., Hirata, Y., Hsu, H.I., Marandos, P.S., Lee, J.S., Chang, T.H., Chu, K.R., Luhmann, Jr., N.C., 2003, W-band heavily loaded TE_{01} gyrotron traveling wave amplifier. 4th IEEE Int. Vacuum Electronics Conf. (IVEC 2003), Seoul, Korea, 348-349.
- [962] Song, H.H., McDermott, D.B., Hirata, Y., Barnett, L.R., Domier, C.W., Hsu, H.L., Chang, T.H., Tsai, W.C., Chu, K.R., Luhmann, Jr., N.C., 2003, Theory and experiment of a 95 GHz gyrotron traveling wave amplifier. Conf. Digest 28th Int. Conf. on Infrared and Millimeter Waves, Otsu, Japan, 205-206.
- [963] Song, H.H., McDermott, D.B., Hirata, Y., Barnett, L.R., Domier, C.W., Hsu, H.L., Chang, T.H., Tsai, W.C., Chu, K.R., Luhmann, Jr., N.C., 2004, Theory and experiment of a 94 GHz gyrotron traveling-wave amplifier. Physics of Plasmas, **11**, 2935-2941.
- [964] Barnett, L.R., Luhmann, N.C., Jr., Chiu, C.C., Chu, K.R., Yan, Y.C., 2007, Advances in W-Band TE_{01} gyro-TWT amplifier design, Proc. 8th IEEE Int. Vacuum Electronics Conference (IVEC 2007), Kitakyushu, Japan, 233.

- [965] Chu, K.R., Barnett, L.R., Lau, W.K., Chang, L.H., Chen H.Y., 1990, A wide-band millimeter-wave gyrotron traveling-wave amplifier experiment. *IEEE Trans. Electron. Devices*, **ED-37**, 1557-1560.
- [966] Chu, K.R., Barnett, L.R., Chen, H.Y., Chen, S.H., Wang, CH., Yeh, Y.S., Tsai, Y.C., Yang, T.T., Dawn, T.Y., 1995, Stabilization of absolute instabilities in the gyrotron traveling wave amplifier. *Phys. Rev. Lett.*, **74**, 1103-1106 and, 1997, private communication.
- [967] Chu, K.R., Chen, H.Y., Hung, C.L., Chang, T.H., Barnett, L.R., Chen, S.H., Yang, T.T., An ultra high gain gyrotron travelling wave amplifier. 1998, *Conf. Digest 23rd Int. Conf. on Infrared and Millimeter Waves*, Colchester, UK, 30-31.
- [968] Chu, K.R., Chen, H.Y., Hung, C.L., Chang, T.H., Barnett, L.R., Chen, S.H., Yang, T.T., 1998, Ultrahigh gain gyrotron travelling wave amplifier. *Phys. Rev. Lett.*, **81**, 4760-4763.
- [969] Chu, K.R., Chang, T.H., Chen, H.Y., Hung, C.L., Barnett, L.R., Chen, S.H., Yang, T.T., 1999, Physics and technology issues of the gyrotron traveling wave amplifier. *Proc. 4th Int. Workshop on Strong Microwaves in Plasmas*, Nizhny Novgorod, ed. A.G. Litvak, Inst. of Applied Physics, Russian Academy of Sciences, Nizhny Novgorod, 2000, **Vol. 2**, 718-727.
- [970] Barnett, L.R., Tsai, W.C., Hsu, H.L., Luhmann, Jr., N.C., Chiu, C.C., Pao, K.F., Chu, K.R., 2006, 140 kW W-band TE₀₁ ultra high gain gyro-TWT amplifier. *Proc. Int. Vacuum Electronics Conference and Int. Vacuum Electron Sources (IVEC/IVESC 2006)*, Monterey, California, USA, 461-462.
- [971] Chiu, C.C., Pao, K.F., Yan, Y.C., Chu, K.R., Barnett, L.R., Luhmann, N.C., 2008, Nonlinearly driven oscillations in the gyrotron traveling-wave amplifier, *Proc. 33rd Int. Conf. on Infrared, Millimeter and Terahertz Waves*, Pasadena, CA, USA, T5D23.1185.
- [972] Wang, H., Li, H., Luo, Y., Yan, R., 2011, Theoretical and experimental investigation of a Ka-band Gyro-TWT with lossy interaction structure, *J. Infrared Milli Terahz Waves*, **32**, 172-185.
- [973] Wang, H., Li, H., Luo Y., Yan, R., 2011, Theoretical and experimental investigation of a Ka-band gyro-TWT with lossy interaction structure, *J. Infrared Milli Terahz Waves*, **32**, 172-185.
- [974] Yan, R., Luo, Y., Liu, G., Pu, Y., 2012, Design and experiment of a Q-band gyro-TWT loaded with lossy dielectric. *IEEE Trans. on Electron Devices*, **59**, 3612-3617.
- [975] Kesar, A., Blank, D., Jerby, E., 2002, Amplitude locking in a gyro TWT amplifier with a delayed feedback. *29th IEEE Int. Conf. on Plasma Science (ICOPS 2002)*, Banff, Canada, May 26-30, 3P18.
- [976] Denisov, G.G., Bratman, V.L., Cross, A.W., He, W., Phelps, A.D.R., Ronald, K., Samsonov, S.V., Whyte, C.G., 1998, Experimental results from a helical waveguide gyro-TWT. *Conf. Digest 23rd Int. Conf. on Infrared and Millimeter Waves*, Colchester, UK, 170-172.
- [977] Denisov, G.G., Bratman, V.L., Cross, A.W., He, W., Phelps, A.D.R., Ronald, K., Samsonov, S.V., Whyte, C.G., 1998, Gyrotron traveling wave amplifier with a helical interaction waveguide. *Phys. Rev. Letters*, **81**, 5680-5683.
- [978] Bratman, V.L., Cross, A.W., Denisov, G.G., He, W., Phelps, A.D.R., Ronald, K., Samsonov, S.V., Whyte, C.G., Young, A.R., 1999, Frequency-broadband gyro-travelling wave amplifier operating with eigenwaves of helically rippled waveguides. *Conf. Digest 24th Int. Conf. on Infrared and Millimeter Waves*, Monterey, California, USA, M-4A, and private communication.
- [979] Bratman, V.L., Cross, A.W., Denisov, G.G., He, W., Phelps, A.D.R., Ronald, K., Samsonov, S.V., Whyte, C.G., Young, A.R., 2000, High-gain wide-band gyrotron travelling wave amplifier with a helically corrugated waveguide. *Phys. Rev. Lett.*, **84**, 2746-2749.

- [980] Phelps, A.D.R., Bratman, V.L., Cross, A.W., Denisov, G.G., He, W., Ronald, K., Samsonov, S.V., Whyte, C.G., Young, A.R., 2001, A broadband, efficient, gyrotron amplifier. Proc. 9th Int. Conf. Displays and Vacuum Electronics, Garmisch-Partenkirchen, ITG-Fachbericht **165**, 193-198.
- [981] Menninger, W.L., Danly, B.G., Temkin, R.J., 1996, Multimegawatt relativistic harmonic gyrotron traveling-wave tube amplifier experiments. IEEE Trans. on Plasma Science, **PS-24**, 687-699.
- [982] Gold, S.H., Fliflet, A.W., Kirkpatrick, D.A., 1989, High-power millimeter-wave gyro-traveling-wave amplifier. Conf. Digest 14th Int. Conf. on Infrared and Millimeter Waves, Würzburg, SPIE **1240**, 332-333.
- [983] Gold, S.H., Kirkpatrick, D.A., Fliflet, A.W., McCowan, R.B., Kinkaed, A.K., Hardesty, D.L., Sucky, M., 1991, High voltage millimeter-wave gyro-travelling-wave amplifier. J. Appl. Phys., **69**, 6696-6698, and Gold, S.H., 1998, private communication.
- [984] Young, A.R., Phelps, A.D.R., He, W., Whyte, C.G., Cross, A.W., Ronald, K., Robertson, C.W., Rafferty, E.G., Thomson, J., 2004, Operation of a thermionic gyro-TWT with a helical interaction waveguide. 5th IEEE Int. Vacuum Electronics Conf. (IVEC 2004), Monterey, CA, USA, 55-56.
- [985] Phelps, A.D.R., Ronald, K., He, W., Young, A.R., Rafferty, E.G., Cross, A.W., Whyte, C.G., Thomson, J., Robertson, C.W., 2004, Results from thermionic cathode gyro-TWA experiments. Conf. Digest 29th Int. Conf. on Infrared and Millimeter Waves and 12th Int. Conf. on Terahertz Electronics, Karlsruhe, Germany, 273-274.
- [986] Young, A.R., Whyte, C.G., Rafferty, E.G., Thomson, J., Robertson, C.W., Phelps, A.D.R., He, W., Cross, A.W., Ronald, K., 2006, Comparison of broadband gyro-TWA simulations with experiments. Conf. Digest 31st Int. Conf. on Infrared and Millimeter Waves and 14th Int. Conf. on Terahertz Electronics, Shanghai, China, 342.
- [987] Cross, A.W., He, W., Phelps, A.D.R., Ronald, K., Whyte, C.G., Young, A.R., Robertson, C.W., Rafferty, E.G., Thomson, J., 2007, Helically corrugated waveguide gyrotron traveling wave amplifier using a thermionic cathode electron gun. Applied Physics Letters, **90**, 253501-1 – 253501-3.
- [988] Rowlands, D.H., Phelps, A.D.R., Young, A.R., Whyte, C.G., He, W., Cross, A.W., Robertson, C.W., Ronald, K., 2007, A cusp gun gyro-TWA with helical interaction region, Proc. 8th IEEE Int. Vacuum Electronics Conference (IVEC 2007), Kitakyushu, Japan, 235-236.
- [989] Whyte, C.G., Young, A.R., Rowlands, D.H., Robertson, C.W., Phelps, A.D.R., He, W., Cross, A.W., Ronald, K., 2008, Broadband gyro-TWA with thermionic CUSP gun: simulations and comparison with experiment, Proc. 9th IEEE Int. Vacuum Electronics Conference (IVEC 2008), Monterey, CA, USA, 91-92.
- [990] Blank, M., Danly, B.G., Levush, B., 1999, Experimental demonstration of a W-band (94 GHz) gyrotwystron amplifier. IEEE Trans. on Plasma Science, **PS-27**, 405-411.
- [991] Zasytkin, E.V., Levush, B., Blank, M., Sokolov, E.V., Antakov, I.I., 1997, Study of X-band three-stage gyrotwystron amplifier. Conf. Digest 22nd Int. Conf. on Infrared and Millimeter Waves, Wintergreen, Virginia, USA, 281-282.
- [992] Blank, M., Zasytkin, E.V., Levush, B., 1998, An investigation of X-band gyrotwystron amplifiers. IEEE Trans. on Plasma Science, **PS-26**, 577-581.
- [993] Liu, B.T., Zhang, Y.S., Zheng, L., 2006, A Ka-Band phigtron with a novel coupled ball-cavity as output. Conf. Digest 31st Int. Conf. on Infrared and Millimeter Waves and 14th Int. Conf. on Terahertz Electronics, Shanghai, China, 201.
- [994] Luo, J., Yuan, G., Luan, Y., Guo, W., Zhu, M., Jiao, C., Zhang, Y., Lou, X., Zheng, L., Wu, E., Liu, B., 2006, First experiment and design of a harmonic multiplying gyrotron traveling wave amplifier with the TE₀₂ mode output. Conf. Digest 31st Int. Conf. on Infrared and Millimeter Waves and 14th Int. Conf. on Terahertz Electronics, Shanghai, China, 339.

- [995] Luo, J., Yuan, G., Zhang, Y., Liu, B., Zheng, L., Guo, W., Zhu, M., Jiao, C., Luan, Y., Lou, X., 2007, A harmonic multiplying gyrotron traveling wave amplifier with the TE₀₂ mode output, Proc. 8th IEEE Int. Vacuum Electronics Conference (IVEC 2007), Kitakyushu, Japan, 229-230 and Liu, P.K., IECAS Beijing, private communication.
- [996] Luo, J., Yuan, G., Zhang, Y., Guo, W., Zhu, M., Jiao, C., Li, Y., Zhang, T., Sun, H., Luan, Y., Zhang, C., Cui, J., 2008, Research progress of the harmonic multiplying gyrotron traveling wave amplifier at Ka Band in IECAS, Proc. 9th IEEE Int. Vacuum Electronics Conference (IVEC 2008), Monterey, CA, USA, 93-94.
- [997] Luo, J., Yuan, G., Zhang, Y., Guo, W., Zhu, M., Jiao, C., Li, Y., Zhang, T., Sun, H., Luan, Y., Zhang, C., Cui, J., 2008, A harmonic multiplying gyrotron traveling wave amplifier at Ka band developed in IECAS, Proc. 33rd Int. Conf. on Infrared, Millimeter and Terahertz Waves, Pasadena, CA, USA, W5D30.1232.
- [998] Luo, J., Zhang, Y., Guo, W., Zhu, M., Yuan, G., Zhou, W., Zhang, C., Cui, J., Zhang, Y., 2009, 8 mm band, 75 kW harmonic multiplying gyrotron traveling amplifier with the bandwidth of more than 1%, Proc. 34th Int. Conf. on Infrared, Millimeter and Terahertz Waves, Busan, Korea, M3D02.0033.
- [999] Luo, J., Jiao, C., Luan, Y., Yuan, G., Guo, W., Zhu, M., Zhang, Y., 2010, Operation of a Ka-band harmonic-multiplying gyrotron traveling-wave tube, IEEE Trans. on Electron Devices, **57**, 27682773.
- [1000] Luo, J., Zhang, Y., Guo, W., Zhu, M., Yuan, G., Cui, J., Zhang, Y., Ren, L., Yang, J., 2010, Operation of a Ka-band harmonic multiplying gyrotron traveling wave tube, Proc. 35th Int. Conf. on Infrared, Millimeter and Terahertz Waves, Rome, Italy, Mo-P.07.
- [1001] Baik, Ch.W., Jeon, S.G., Kim, D.H., Sato, N., Yokoo, K., Park, G.S., 2005, Third-harmonic frequency multiplication of a two-stage tapered gyrotron TWT amplifier. IEEE Trans. on Electron Devices, **52**, 829-838.
- [1002] Guo, H., Chen, S.-H., Granatstein, V.L., Rodgers, J., Nusinovich, G.S., Walter, M.T., Zhao, J., Chen, W., 1998, Operation of a high performance, harmonic-multiplying, inverted gyrotwystron. IEEE Trans. on Plasma Science, **PS-26**, 451-460.
- [1003] Guo, H., Chen, S.H., Granatstein, V.L., Rodgers, J., Nusinovich, G. Walter, M., Levush, B., Chen, W.J., 1997, Operation of a highly overmoded, harmonic-multiplying gyrotron amplifier. Phys. Rev. Lett, **79**, 515-518.
- [1004] Rodgers, J., Guo, H., Granatstein, V.L., Chen, S.H., Nusinovich, G.S., Walter, M., Zhao, J., 1999, High efficiency, phase-locked operation of the harmonic-multiplying inverted gyrotwystron oscillator. IEEE Trans. on Plasma Science, **PS-27**, 412-421.
- [1005] Guo, H., Rodgers, J., Zhao, J., Miao, Y.Y., Chen, W.J., Granatstein, V.L., 2000, Latest progress in studies of harmonic multiplying gyro-amplifiers. Conf. Digest 25th Int. Conf. on Infrared and Millimeter Waves, Beijing, P.R. China, 317-318.
- [1006] Guo, H., Miao, Y.Y., Rodgers, J., Granatstein, V.L., Wu, R.S., Luo, J.R., Wu, D.S., Yin, Y.L., Miao, H., Zhang, Y.S. Cai, Z.P., Zheng, L., Su, Y.N., Guo, W., Luan, Y.T., Ding, Y.G., 2002, A new triplet gyrotron amplifier, the gyrotriotron. Proc. 3rd IEEE Int. Vacuum Electronics Conf. (IVEC 2002), Monterey, USA, 119-120.
- [1007] Guo, H., Miao, Y.Y., Rodgers, F., Granatstein, V.L., Wu, R.S., Luo, J.R., Wu, D.S., Yin, Y.L., Miao, Y.H., Zhang, Y.S., Cai, Z.P., Zheng, L., Su, Y.N., Guo, W., Luan, Y.T., Ding, Y.G., 2002, Initial experimental results of a new triplet harmonic-multiplying gyrotron amplifier (gyrotriotron). Proc. 27th Int. Conf. on Infrared and Millimeter Waves, San Diego, USA, 205-206.
- [1008] Lawson, W., Latham, P.E., Calame, J.P., Cheng, J., Hogan, B., Nusinovich, G.S., Irwin, V., Granatstein, V.L., Reiser, M., 1995, High power operation of first and second harmonic gyrotwystrons. J. Appl. Phys., **78**, 550-559.

- [1009] He, W., Cross, A.W., Whyte, C.G., Young, A.R., Phelps, A.D.R., Ronald, K., Rafferty, E.G., Thomson, J., Robertson, C.W., Speirs, D.C., Samsonov, S.V., Bratman, V.L., Denisov, G.G., 2004, Gyro-BWO experiment using a helical interaction waveguide. 5th IEEE Int. Vacuum Electronics Conf. (IVEC 2004), Monterey, CA, USA, 206-207.
- [1010] He, W., Cross, A.W., Whyte, C.G., Young, A.R., Phelps, A.D.R., Ronald, K., Rafferty, E.G., Thomson, J., Robertson, C.W., Speirs, D.C., 2004, Thermionic gyro-BWO experiment using a helical interaction waveguide. Conf. Digest 29th Int. Conf. on Infrared and Millimeter Waves and 12th Int. Conf. on Terahertz Electronics, Karlsruhe, Germany, 233-234.
- [1011] He, W., Ronald, K., Young, A.R., Cross, A.W., Phelps, A.D.R., Whyte, C.G., Rafferty, E.G., Thomson, J., Robertson, C.W., Speirs, D.V., Samsonov, S.V., Bratman, V.L., Denisov, G.G., 2005, Gyro-BWO experiments using a helical interaction waveguide. IEEE Trans. on Electron Devices, **52**, 839-844.
- [1012] He, W., Whyte, C.G., Cross, A.W., Young, A.R., Phelps, A.D.R., Ronald, K., Rafferty, E.G., Thomson, J., Robertson, C.W., Samsonov, S.V., Bratman, V.L., Denisov, G.G., 2005, Experiments and simulations of a gyro-BWO using a helical interaction waveguide. Proc. 6th Int. Workshop on Strong Microwaves in Plasmas, Nizhny Novgorod, ed. A.G. Litvak, Inst. of Applied Physics, Russian Academy of Sciences, Nizhny Novgorod, 2006, **Vol. 1**, 125-134.
- [1013] Denisov, G.G., Samsonov, S.V., Bratman, V.L., Bogdashov, A.A., Glyavin, M.Yu., Luchinin, A.G., Lygin, V.K., Thumm, M., 2004, Frequency-tunable CW gyro-BWO with a helically rippled operating waveguide. Conf. Digest 29th Int. Conf. on Infrared and Millimeter Waves and 12th Int. Conf. on Terahertz Electronics, Karlsruhe, Germany, 235-236.
- [1014] Samsonov, S.V., Denisov, G.G., Bratman, V.L., Bogdashov, A.A., Glyavin, M.Yu., Luchinin, A.G., Lygin, V.K., Thumm, M.K., 2004, Frequency-tunable CW gyro-BWO with a helically rippled operating waveguide. IEEE Trans. on Plasma Science, **PS-32**, 884-889.
- [1015] Liu, B.-T., Jiao, C.-Q., Zhang, Y.S., Yuan, G.-J., Guo, W., Zheng, L., 2007, Experimental study of a Ku-Band gyrotron backward-wave oscillator with a single stage depressed collector. IEEE Trans. on Plasma Science, **PS-35**, 1065-1069.
- [1016] Liu, B., 2006, Experimental study of a Ku-Band gyrotron backward-wave oscillator with a single stage depressed collector and linear-mode output. Conf. Digest 31st Int. Conf. on Infrared and Millimeter Waves and 14th Int. Conf. on Terahertz Electronics, Shanghai, China, 80.
- [1017] Basten, M.A., Guss, W.C., Kreischer, K.E., Temkin, R.T., Caplan, M., 1995, Experimental investigation of a 140 GHz gyrotron-backward wave oscillator. Int. J. Infrared and Millimeter Waves, **16**, 880-905.
- [1018] Park, S.Y., Kyser, R.H., Armstrong, C.M., Parker, R.K., Granatstein, V.L., 1990, Experimental Study of a Ka-band gyrotron backward-wave oscillator. IEEE Trans. on Plasma Science, **PS-18**, 321-325.
- [1019] Kou, C.S., Chen, S.H., Barnett, L.R., Chu, K.R., 1993, Experimental study of an injection locked gyrotron backward wave oscillator. Phys. Rev. Lett., **70**, 924-927.
- [1020] Chang, T.H., Chen, S.H., Cheng, F.H., Kou, C.S., Chu, K.R., 1999, Experimental study of an injection locked gyro-BWO. Conf. Digest 24th Int. Conf. on Infrared and Millimeter Waves, Monterey, California, USA, M-A2.
- [1021] Chu, K.R., Chen, S.H., Chang, T.H., 2000, Review of the gyrotron backward wave oscillator. Conf. Digest 25th Int. Conf. on Infrared and Millimeter Waves, Beijing, P.R. China, 9-10.
- [1022] Fan, C.T., Chang, T.H., Pao, K.F., Chen, S.H., Chu, K.R., 2006, Stability and tunability of a gyrotron backward-wave oscillator. Conf. Digest 31st Int. Conf. on Infrared and Millimeter Waves and 14th Int. Conf. on Terahertz Electronics, Shanghai, China, 517.

- [1023] Chang, T.H., Fan, C.T., Pao, K.F., Chu, K.R., Chen, S.H., 2007, Stability and tunability of the gyrotron backward-wave oscillator. *Applied Physics Letters*, **90**, 191501-1 – 19150-3.
- [1024] Fan, C.T., Chang, T.H., Pao, K.F., Chu, K.R., Chen, S.H., 2007, Stable, high efficiency gyrotron backward-wave oscillator, *Physics of Plasmas*, **14**, 093102 – 093102-8.
- [1025] Pao, K.F., Tan, C.T., Chang, T.H., Chiu, C.C., Chu, K.R., 2007, Selective suppression of high order axial modes of the gyrotron backward-wave oscillator, *Physics of Plasmas*, **14**, 093301-1 - 093301-7.
- [1026] Chen, N.C., Yu, C.F., Yuan, C.P., Chang, T.H., 2009, A mode-selective circuit for TE₀₁ gyrotron backward-wave oscillator with wide-tuning range, *Proc. 34th Int. Conf. on Infrared, Millimeter and Terahertz Waves*, Busan, Korea, M3D01.0369.
- [1027] Chen, N.C., Yu, C.F., Yuan, C.P., Chang, T.H., 2009, A mode-selective circuit for TE₀₁ gyrotron backward-wave oscillator with wide-tuning range, *Applied Physics Letters*, **94**, 101501-1 – 101501-3.
- [1028] He, W., Donaldson, C.R., Cross, A.W., Li, F., Phelps, A.D.R., Zhang, L., Ronald, K., Robertson, C.W., Whyte, C.G., Young, A.R., 2009, Experiment of a high power W-band gyro-BWO using a helically corrugated waveguide, *Proc. 34th Int. Conf. on Infrared, Millimeter and Terahertz Waves*, Busan, Korea, M5E60.0363.
- [1029] Donaldson, C.R., He, W., Cross, A.W., Li, F., Phelps, A.D.R., Zhang, L., Ronald, K., Robertson, C.W., Whyte, C.G., McElhinney, P., 2010, Experimental demonstration of a W-band gyro-BWO using a helically corrugated waveguide, *Proc. 11th IEEE Int. Vacuum Electronics Conference (IVEC 2010)*, Monterey, USA, pp. 195-196.
- [1030] Donaldson, C.R., He, W., Phelps, A.D.R., Li, F., Zhang, L., Cross, A.W., Ronald, K., Robertson, C.W., Whyte, C.G., Young, A.R., 2010, Experimental demonstration of a W-band gyro-BWO using a helically corrugated waveguide, *Proc. 35th Int. Conf. on Infrared, Millimeter and Terahertz Waves*, Rome, Italy, Mo-E3.1.
- [1031] Schriever, R.L., Johnson, C.C., 1966, A rotating beam waveguide oscillator. *Proc. of the IEEE*, 2029-2030.
- [1032] Bratman, V.L., Denisov, G.G., Phelps, A.D.R., Samsonov, S.V., 1998, Gyro-TWTs and gyro-BWOs with helical waveguides. *Proc. Research Workshop of the Israel Science Foundation on Cyclotron Resonance Masers and Gyrotrons*, Kibbutz Ma'ale Hachamisha, Israel, 252-264.
- [1033] Bratman, V.L., Fedotov, A.E., Savilov, A.V., 1999, A new type of gyro-BWO (gyro-BWT-TWT). *Conf. Digest 24th Int. Conf. on Infrared and Millimeter Waves*, Monterey, California, USA, TH-E6.
- [1034] Kamada, K., Nawashiro, K., Tamagawa, F., Igarashi, H., Kizu, S., Lee, C.-Y., Kawasaki, S., Ando, R., Masuzaki, M., 1998, Backward wave oscillator experiments with a relativistic electron beam using an X-band rectangular waveguide. *Int. J. of Infrared and Millimeter Waves*, **19**, 1317-1324.
- [1035] Kamada, K., Nawashiro, K., Tamagawa, F., Lee, C.-Y., Yoshida, H., Kawasaki, S., Ando, R., Masuzaki, M., 2000, Dependence of output power on cavity length in a gyrotron backward wave oscillator. *Int. J. of Infrared and Millimeter Waves*, **21**, 1441-1449.
- [1036] Walter, M.T., Gilgenbach, R.M., Menge, P.R., Spencer, T.A., 1994, Effects of tapered tubes on long-pulse microwave emission from intense e-beam gyrotron-backward-wave oscillators. *IEEE Trans. Plasma Sciences*, **PS-22**, 578-584.
- [1037] Walter, M.T., Gilgenbach, R.M., Luginsland, J.W., Hochman, J.M., Rintamaki, J.I., Jaynes, R.L., Lau, Y.Y., Spencer, T.A., 1996, Effects of tapering on gyrotron backward-wave oscillators. *IEEE Trans. on Plasma Science*, **PS-24**, 636-647.
- [1038] Spencer, T.A., Arman, M.J., Hendricks, K.J., Hackett, K.E., Stump, M., Gilgenbach, R.M., 1995, Non-axisymmetric mode competition in a high current, high voltage TE₀₁ gyrotron-backward-wave oscillator experiment. *Conf. Digest 20th Int. Conf. on Infrared and Millimeter Waves*, Lake Buena Vista (Orlando), Florida, 536-537.

- [1039] Spencer, T.A., Davis, C.E., Hendricks, K.J., Agee, F.J., Gilgenbach, R.M., 1996, Results from gyrotron backward wave oscillator experiments utilizing a high-current high-voltage annular electron beam. *IEEE Trans. on Plasma Science*, **PS-24**, 630-635.
- [1040] Dressman, L.J., McDermott, D.B., Luhmann, N.C., Jr., Gallagher, D.A., 2007, UCD 34 GHz harmonic peniotron, *Proc. 8th IEEE Int. Vacuum Electronics Conference (IVEC 2007)*, Kitakyushu, Japan, 253-254.
- [1041] Ono, S., Yamanouchi, K., Shibata, Y., Koike, Y., 1962, Cyclotron fast-wave tube using spatial harmonic interaction- the traveling wave peniotron. *Proc. 4th Int. Congress Microwave Tubes*, Scheveningen, 355-363.
- [1042] Ono, S., Tsutaki, K., Kageyama, T., 1984, Proposal of a high efficiency tube for high power millimetre or submillimetre wave generation: The gyro-peniotron. *Int. J. Electronics*, **56**, 507-519.
- [1043] Yokoo, K., Razeghi, M., Sato, N., Ono, S., 1988, High efficiency operation of the modified peniotron using TE₁₁ rectangular waveguide cavity. *Conf. Digest, 13th Int. Conf. on Infrared and Millimeter Waves*, Honolulu, Hawaii, *Proc.*, SPIE **1039**, 135-136
- [1044] Yokoo, K., Musyoki, S., Nakazato, Y., Sato, N., Ono, S., 1990, Design and experiments of auto-resonant peniotron oscillator. *Conf. Digest 15th Int. Conf on Infrared and Millimeter Waves*, Orlando, *Proc.*, SPIE **1514**, 10-12.
- [1045] Yokoo, K., Shimawaki, H., Tadano, H., Ishihara, T., Sagae, N., Sato, N., Ono, S., 1992, Design and experiments of higher cyclotron harmonic peniotron oscillators. *Conf. Digest 17th Int. Conf. on Infrared and Millimeter Waves*, Pasadena, *Proc.*, SPIE **1929**, 498-499.
- [1046] Musyoki, S., Sagae, K., Yokoo, K., Sato, N., Ono, S., 1992, Experiments on highly efficient operation of the auto-resonant peniotron oscillator. *Int. J. Electronics*, **72**, 1067-1077.
- [1047] Yokoo, K., Ishihara, T., Sagae, K., Shimawaki, H., Sato, N., 1997, Experiments of space harmonic peniotron for cyclotron high harmonic operation. *Conf. Digest 22nd Int. Conf. on Infrared and Millimeter Waves*, Wintergreen, Virginia, USA, 206-207.
- [1048] Yokoo, K., Ishihara, T., Sagae, K., Sato, N., Shimawaki, H., 1998, Efficient operation of high harmonic peniotron in millimeter wave region. *Proc. 8th ITG-Conference on Displays and Vacuum Electronics*, Garmisch-Partenkirchen, *ITG-Fachbericht* **150**, 447-452.
- [1049] Ishihara, T., Sagae, K., Sato, N., Shimawaki, H., Yokoo, K., 1999, Highly efficient operation of space harmonic peniotron at cyclotron high harmonics. *IEEE Trans. on Electron Devices*, **ED-46**, 798-802.
- [1050] Ono, S., Ansai, H., Sato, N., Yokoo, K., Henmi, K., Idehara, T., Tachikawa, T., Okazaki, I., Okamoto, T., 1986, Experimental study of the 3rd harmonic operation of gyro-peniotron at 70 GHz. *Conf. Digest 11th Int. Conf. on Infrared and Millimeter Waves*, Pisa, 37-39, and Okazaki, Y., 1994, private communication, Toshiba, Otawara, Japan.
- [1051] Ostreiko, G.N., Kozyrev, E.V., Makarov, I.G., Nezhevenko, O.A., Persov, B.Z., Serdobintsev, G.V., Shchelkunoff, S.V., Tarnetsky, V.V., Yakolov, V.P., Zapryagaev, I.A., 1996, The results of 7 GHz pulse magnicon investigation. *Proc. 3rd Int. Workshop on Strong Microwaves in Plasmas*, Nizhny Novgorod, 1997, Vol.2, 861-870.
- [1052] Kozyrev, E.V., Nezhevenko, O.A., Nikiforov, A.A., Ostreiko, G.N., Persov, B.Z., Serdobintsev, G.V., Shchelkunoff, S.V., Tarnetsky, V.V., Yakovlev, V.P., Zapryagaev, I.A., 1999, 7 GHz 55 MW pulsed magnicon. *Proc. 4th Int. Workshop on Strong Microwaves in Plasmas*, Nizhny Novgorod, ed. A.G. Litvak, Inst. of Applied Physics, Russian Academy of Sciences, Nizhny Novgorod, 2000, **Vol. 2**, 740-746.
- [1053] Kozyrev, E.V., Nezhevenko, O.A., Nikiforov, A.A., Ostreiko, G.N., Shchelkunoff, S.V., Serdobintsev, G.V., Tarnetsky, V.V., Yakovlev, V.P., Zapryagaev, I.A., 1998, Present status of Budker INP 7 GHz pulsed magnicon. *Proc. Radio Frequency Workshop (RF 98)*, High Energy Density Microwaves, Pajaro Dunes, California, USA, *AIP Conference Proceedings* **474**, 1999, 187-194.

- [1054] Gold, S.H., Kinkead, A.K., Fliflet, A.W., Hafiza, B., Manheimer, W.A., 1996, Initial operation of a high-power frequency-doubling X-band magnicon amplifier. *IEEE Trans. on Plasma Science*, **PS-24**, 947-956.
- [1055] Gold, S.H., Nezhevenko, O.A., Yakovlev, V.P., Kinkead, A.K., Fliflet, A.W., Kozyrev, E.V., True, R., Hansen, R.J., Hirshfield, J.L., Status report on the 11.424-GHz magnicon amplifier. Ed. R.M. Phillips, *High Energy Density Microwaves*, 1999, **AICP-CP474**, 179-186.
- [1056] Nezhevenko, O.A., LaPointe, M.A., Yakovlev, V.P., Hirshfield, J.L., 2003, 34 GHz, 45 MW pulsed magnicon: first results. *Proc. 6th Workshop of High Energy Density and High Power RF*, Berkeley Springs, West Virginia, 89.
- [1057] Hirshfield, J.L., Nezhevenko, O.A., LaPointe, M.A., Yakovlev, V.P., 2004, Technology developments for a future millimeter-wave high-gradient linear accelerator. *Conf. Digest 29th Int. Conf. on Infrared and Millimeter Waves and 12th Int. Conf. on Terahertz Electronics*, Karlsruhe, Germany, 529-530.
- [1058] Gold, S.H., Fliflet, A.W., Hornstein, M.K., Kinkead, A.K., 2008, Observation of mode competition in an 11.4-GHz magnicon amplifier, *IEEE Trans. on Plasma Science*, **36**, 597-605.
- [1059] Nezhevenko, O.A., Yakovlev, V.P., Hirshfield, J.L., LaPointe, M.A., Kozyrev, E.V., Gold, S.H., Fliflet, A.W., Kinkead, A.K., Shchelkunov, S.V., 2005, High-power millimeter- and centimeter-wave magnicons for particle accelerator applications. *Proc. 7th Workshop on High Energy Density and High Power RF*, AIP Conference Proceedings **807**, 2006, 146-157.
- [1060] Nezhevenko, O.A., LaPointe, M.A., Yakovlev, V.P., Hirshfield, J.L., 2004, Commissioning of the 34-GHz, 45-MW pulsed magnicon. *IEEE Trans. on Plasma Science*, **PS-32**, 994-1001.
- [1061] Hirshfield, J.L., Bogdashov, A.A., Chirkov, A.V., Denisov, G.G., Fix, A.S., Kuzikov, S.V., LaPointe, M.A., Litvak, A.G., Lukovnikov, D.A., Malygin, V.I., Nezhevenko, O.A., Petelin, M.I., Rodin, Yu.V., Serdobintsev, G.V., Shmelyov, M.Y., Yakovlev, V.P., 2005, Transmission line components for a future millimeter-wave high-gradient linear accelerator. In: *Quasi-Optical Control of Intense Microwave Transmission*, eds. J.L. Hirshfield and M.I. Petelin, 147-163.
- [1062] Nezhevenko, O.A., Yakovlev, V.P., LaPointe, M.A., Kozyrev, E.V., Shchelkunov, S.V., Hirshfield, J.L., 2005, High-power millimeter-wave magnicon amplifier. *Conf. Digest 30th Int. Conf. on Infrared and Millimeter Waves and 13th Int. Conf. on Terahertz Electronics*, Williamsburg, VA, USA, 95-96.
- [1063] LaPointe, M.A., Hirshfield, J.L., Kozyrev, E.V., Nezhevenko, O.A., Shchelkunov, S.V., Yakovlev, V.P., 2006, 34 GHz magnicon for a Ka-band test facility. *Conf. Digest 31st Int. Conf. on Infrared and Millimeter Waves and 14th Int. Conf. on Terahertz Electronics*, Shanghai, China, 127.
- [1064] Bottolier-Curtet, H., Gardelle, J., Bardy, J., Bonnafond, C., Devin, A., Gardent, D., Germain, G., Gouard, Ph., Labrousche, J., Launspach, J., Le Taillandier, P., de Mascureau, J., 1992, Progress in free electron maser experiments at CESTA. *Nucl. Instr. Meth.*, **A318**, 131-134.
- [1065] Rullier, J.L., Gardelle, J., Labrousche, J., Le Taillandier, P., 1995, Strong coupling operation of a FEL amplifier with an axial magnetic field. *Nucl. Instr. Meth.*, **A358**, 118-121, and 1996, *Phys. Rev. E*, **53**, 2787-2794.
- [1066] Gardelle, J., Labrousche, J., Marchese, G., Rullier, J.L., Villate, D., 1996, Analysis of the beam bunching produced by a free electron laser. *Physics of Plasmas*, **3**, 4197-4206.
- [1067] Gardelle, J., Lefevre, T., Marchese, G., Rullier, J.L., Donohue, J.T., 1997, High-power operation and strong bunching at 3 GHz produced by a 35-GHz free-electron-laser amplifier. *Phys. Rev. Lett.*, **79**, 3905-3908.

- [1068] Gardelle, J., Lefevre, T., Marchese, G., Rullier, J.L., Donohue, J.T., 1997, Measurements of microwave power and frequency in a pulsed free electron laser amplifier. *IEEE Trans. on Plasma Science*, **PS-25**, 1419-1424.
- [1069] Donohue, J.T., Gardelle, J., Lefevre, T., Marchese, G., Padois, M., Rullier, J.L., 1999, Comparison of beam bunching in amplifier and SASE modes at the CEA-CESTA free-electron laser. *Nucl. Instr. Meth. in Phys. Research*, **A 429**, 202-208.
- [1070] Lefevre, T., Gardelle, J., Marchese, G., J.L. Rullier, Donohue, J.T., 1999, Self-amplified spontaneous emission and bunching at 3 GHz in a microwave free-electron laser. *Phys. Rev.Lett.*, **82**, 323-326.
- [1071] Donohue, J.T., Gardelle, J., Lefevre, T., Rullier, J.L., Vermare, C., Lidia, S.M., Meurdesoif, Y., 2000, Power generation in a resonant cavity using a beam bunched at 35 GHz by a free electron laser. *Nucl. Instr. and Meth. in Phys. Res.*, **A 445**, 307-312.
- [1072] Lefevre, T., Gardelle, J., Rullier, J.L., Vermare, C., Donohue, J.T., Meurdesoif, Y., Lidia, S.M., 2000, Free-electron laser as a driver for a resonant cavity at 35 GHz. *Phys. Rev. Lett.*, **84**, 1188-1191.
- [1073] Lefevre, T., Gardelle, J., Rullier, J.-L., Donohue, J.T., Lidia, S.M., 2000, Microwave production by a free-electron laser bunched beam driving a resonant cavity at 35 GHz. *IEEE Trans. on Plasma Science*, **PS-28**, 812-820.
- [1074] Gardelle, J., Modin, P., Courtois, L., Donohue, J.T., 2009, Progress of the microwave coherent Smith-Purcell experiment at CESTA, *IEEE 36th Int. Conf. on Plasma Science and 23rd Symp. on Fusion Eng.*, San Diego, Paper IP3D-13.
- [1075] Dodd, J.W., Marshall, T.C., 1990, Spiking Radiation in the Columbia free electron laser. *IEEE Trans. Plasma Science*, **PS-18**, 447-450.
- [1076] Marshall, T.C., Cecere, M.A., 1994, A measurement of space-charge fields in a microwave free electron laser. *Physica Scripta*, **T52**, 58-60.
- [1077] Cecere, M., Marshall, T.C., 1994, A free electron laser experiment on angular steering. *IEEE Trans. Plasma Science*, **PS-22**, 654-658.
- [1078] Renz, G. Spindler, G., 1995, Status of the Stuttgart Raman free-electron laser project. *Nucl. Instr. Meth.*, **A358**, ABS13.
- [1079] Ciocci, F., Bartolini, R., Doria, A., Gallerano, G.P., Giovenale, E., Kimmitt, M.F., Messina, G., Renieri, A., 1993, Operation of a compact free-electron laser in the millimeter-wave region with a bunched electron beam. *Phys. Rev. Lett.*, **70**, 928-931.
- [1080] Gallerano, G.P., 1994, The free electron laser: state of the art, developments and applications. *Nucl. Instr. Meth.*, **A340**, 11-16.
- [1081] Doria, A., Gallerano, G.P., Giovenale, G., Kimmitt, M.F., Messina, G., 1996, The ENEA F-CUBE facility: trends in rf driven compact FELs and related diagnostics. *Nucl. Instr. Meth.*, **A375**, ABS11-ABS13.
- [1082] Gallerano, G.P., Doria, A., Giovenale, E., Messina, G., Spassovsky, I., 2003, Long wavelength THz compact free electron lasers. *Conf. Digest 28th Int. Conf. on Infrared and Millimeter Waves*, Otsu, Japan, 57-58.
- [1083] Doria, A., Gallerano, G.P., Giovenale, E., Messina, G., Petralia, A., Spassovsky, I., 2009, The ENEA activity on compact FAR infrared FELs, *Proc. 10th IEEE Int. Vacuum Electronics Conference (IVEC 2009)*, Rome, Italy, pp. 544-545.
- [1084] Hartemann, F., Buzzi, J.M., 1988, Experimental studies of a millimeter-wave free-electron laser. *Proc. 7th Int. Conf. on High-Power Particle Beams*, Karlsruhe 1988, eds., Bauer, W., Schmidt, W., **Vol. II**, 1287-1292.
- [1085] Bongers, W.A., Militsyn, B.L., Bratman, V.L., Caplan, M., Denisov, G.G., van der Geer, C.A.J., Manintveld, P., Oomens, A.A.M., Plomp, J., Pluygers, J., Poelman, A.J., Riet, M., Savilov, A.V., Smeets, P.H.M., Tito, C.J., Turk, G.H.B., Varfolomeev, A.A., Verhoeven, A.G.A., Urbanus, W.H., 2001, New results of the fusion-FEM in long-pulse set up. *Conf. Digest, 26th Int. Conf. on Infrared and Millimeter Waves*, Toulouse, France, 6-24-6-27.

- [1086] Bratman, V.L., Denisov, G.G., Ofitserov, M.M., Korovin, S.D., Polevin, S.D., Rostov, V.V., 1987, Millimeter-wave hf relativistic electron oscillators. *IEEE Trans. Plasma Science*, **PS-15**, 2-15.
- [1087] Peskov, N.Yu., Bratman, V.L., Ginzburg, N.S., Denisov, G.G., Kolchugin, B.D., Samsonov, S.V., Volkov, A.B., 1996, Experimental study of a high-current FEM with a broadband microwave system. *Nucl. Instr. Meth.*, **A375**, 377-380.
- [1088] Bratman, V.L., Denisov, G.G., Ginzburg, N.S., Kol'chugin, B.D., Peskov, N.Y., Samsonov, S.V., Volkov, A.B., 1996, Experimental study of an FEM with a microwave system of a new type. *IEEE Trans. on Plasma Science*, **PS-24**, 744-749.
- [1089] Arzhannikov, A.V., Bobylev, V.B., Sinitsky, S.L., Tarasov, A.V., Ginzburg, N.S., Peskov, N.Yu., 1995, Ribbon-FEL experiments at one-dimension distributed feedback. *Nucl. Instr. Meth.*, **A358**, 112-113.
- [1090] Agafonov, M.A., Arzhannikov, A.V., Ginzburg, N.S., Peskov, N.Yu., Sinitsky, S.L., Tarasov, A.V., 1996, Powerful FEM generator driven by microsecond sheet beam. *Proc. 11th Conf. on High Power Particle Beams, Prague, BEAMS-96*, **Vol. 1**, 213-216.
- [1091] Agafonov, M.A., Arzhannikov, A.V., Ginzburg, N.S., Ivanenko, V.G., Kalinin, P.V., Kuznetsov, S.A., Peskov, N.Yu., Sinitsky, S.L., 1997, Generation of hundred joules RF-pulse at 4 mm wavelength by FEL with sheet beam. *Digest of Technical Papers, Workshop on High Power Microwave Generation and Pulse Shortening, Edinburgh, UK*, 195-190.
- [1092] Agafonov, M.A., Arzhannikov, A.V., Ginzburg, N.S., Ivanenko, V.G., Kalinin, P.V., Kuznetsov, S.A., Peskov, N.Yu., Sinitsky, S.L., 1998, Generation of hundred joules RF-pulse at 4 mm wavelength by FEM with sheet electron beam. *IEEE Trans. on Plasma Science*, **PS-26**, 531-535.
- [1093] Agarín, N.V., Arzhannikov, A.V., Bobylev, V.B., Ginzburg, N.S., Ivanenko, V.G., Kalinin, P.V., Kuznetsov, S.A., Peskov, N.Yu., Sergeev, A.S., Sinitsky, S.L., Stepanov, V.D., 1999, Generation of hundred joules pulses of 4-mm radiation by planar FEM with two-dimensional distributed feedback. *Proc. 4th Int. Workshop on Strong Microwaves in Plasmas, Nizhny Novgorod*, ed. A.G. Litvak, Inst. of Applied Physics, Russian Academy of Sciences, Nizhny Novgorod, 2000, **Vol. 2**, 802-814.
- [1094] Agarín, N.V., Arzhannikov, A.V., Bobylev, V.B., Ginzburg, N.S., Ivanenko, V.G., Kalinin, P.V., Kuznetsov, S.A., Peskov, N.Yu., Sergeev, A.S., Sinitsky, S.L., Stepanov, V.D., 2000, First operation of a powerful FEL with two-dimensional distributed feedback. *Nucl. Instr. and Meth. in Phys. Res.*, **A 445**, 222-229.
- [1095] Arzhannikov, A.V., Astrelín, V.T., Bobylev, V.B., Ginzburg, N.S., Kalinin, P.V., Kuznetsov, S.A., Peskov, N.Yu., Petrov, P.V., Sergeev, A.S., Sinitsky, S.L., Stepanov, V.D., Thumm, M., 2002, Generation of powerful coherent radiation in single- and multi-modules planar FEMs with 2-D distributed feedback: results and prospects. *Proc. 5th Int. Workshop on Strong Microwaves in Plasmas, Nizhny Novgorod*, ed. A.G. Litvak, Inst. of Applied Physics, Russian Academy of Sciences, Nizhny Novgorod, 2003, **Vol. 1**, 203-210.
- [1096] Arzhannikov, A.V., Ginzburg, N.S., Kalinin, P.V., Kuznetsov, A.S., Kuznetsov, S.A., Peskov, N.Yu., Sergeev, A.S., Sinitsky, S.L., Thumm, M., 2004, Planar FEM resonator with reflectors composed by Bragg gratings. *Proc. 10th Int. Conf. Displays and Vacuum Electronics, Garmisch-Partenkirchen, ITG-Fachbericht 183*, 193, Invited Paper.
- [1097] Arzhannikov, A.V., Ginzburg, N.S., Kalinin, P.V., Kuznetsov, A.S., Kuznetsov, S.A., Peskov, N.Yu., Sergeev, A.S., Sinitsky, S.L., Stepanov, V.D., Zaslavsky, V.Yu., Thumm, M., 2004, Frequency spectrum generated by planar FEM at ELMI-device. *Conf. Digest 29th Int. Conf. on Infrared and Millimeter Waves and 12th Int. Conf. on Terahertz Electronics, Karlsruhe, Germany*, 565-566.

- [1098] Arzhannikov, A.V., Ginzburg, N.S., Kalinin, P.V., Kuznetsov, S.A., Peskov, N.Yu., Rozental, R.M., Sergeev, A.S., Sinitsky, S.L., Stepanov, V.D., Thumm, M., Zaslavsky, V.Yu., Zotova, I.V., 2005, Intercavity scattering scheme for two-stage generation of submillimeter radiation on the base of planar 2D Bragg FEM. Proc. 6th Int. Workshop on Strong Microwaves in Plasmas, Nizhny Novgorod, ed. A.G. Litvak, Inst. of Applied Physics, Russian Academy of Sciences, Nizhny Novgorod, 2006, **Vol. 1**, 228-232.
- [1099] Peskov, N.Yu., Ginzburg, N.S., Denisov, G.G., Kuzikov, S.V., Sergeev, A.S., Arzhannikov, A.V., Kalinin, P.V., Rozental, R.M., Sinitsky, S.L., Thumm, M., Zaslavsky, V.Yu., 2005, Peculiarities of mode spectrum of planar 2D Bragg resonator (theory and experiment). Proc. 6th Int. Workshop on Strong Microwaves in Plasmas, Nizhny Novgorod, ed. A.G. Litvak, Inst. of Applied Physics, Russian Academy of Sciences, Nizhny Novgorod, 2006, **Vol. 1**, 321-329.
- [1100] Peskov, N.Yu., Ginzburg, N.S., Denisov, G.G., Zaslavskii, V.Yu., Kuzikov, S.V., Sergeev, A.S., Arzhannikov, A.V., Kalinin, P.V., Sinitskii, S.L., Thumm, M., 2007, Experimental observation of high-Q modes at the center of a resonance band of two-dimensional Bragg structures, *Techn. Phys. Letters*, **33**, 117-121.
- [1101] Ginzburg, N.S., Peskov, N.Yu., Sergeev, A.S., Zaslavsky, V.Yu., Arzhannikov, A.V., Kalinin, P.V., Sinitsky, A.L., Phelps, A.D.R., Konoplev, I.V., Cross, A.W., Thumm, M., 2007, Two dimensional Bragg structures (Modeling and experimental testing of selective properties), *Conf. Digest Joint 32nd Int. Conf. on Infrared and Millimetre Waves and 15th Int. Conf. on Terahertz Electronics*, Cardiff, UK, 833-834.
- [1102] Arzhannikov, A.V., Astrelin, V.T., Ginzburg, N.S., Kalinin, P.V., Kuznetsov, A.S., Kuznetsov, S.A., Peskov, N.Yu., Sergeev, A.S., Sinitsky, S.L., Stepanov, V.D., Zaslavsky, V.Yu., Zotova, I.V., 2007, Submillimeter radiation production by intercavity stimulated scattering in planar FEM at the ELMI-device. *Conf. Digest 32nd Int. Conf. on Infrared and Millimeter Waves and 15th Int. Conf. on Terahertz Electronics*, Cardiff, UK, 835-836.
- [1103] Ginzburg, N.S., Peskov, N.Yu., Sergeev, A.S., Denisov, G.G., Kuzikov, S.V., Zaslavsky, V.Yu., Arzhannikov, A.V., Kalinin, P.V., Sinitsky, S.L., Thumm, M., 2008, Observation of the high-Q modes inside the resonance zone of two-dimensional Bragg structures, *Applied Physics Letters*, **92**, 103512-1-3.
- [1104] Ginzburg, N.S., Peskov, N.Yu., Sergeev, A.S., Zaslavsky, V.Yu., Konoplev, I.V., Fisher, L., Ronald, K., Phelps, A.D.R., Cross, A.W., Thumm, M., 2009, *Journal of Applied Physics*, **105**, 124519-1 – 124519-10.
- [1105] Arzhannikov, A.V., Cross, A.W., Ginzburg, N.S., He, Wenlong, Kalinin, P.V., Konoplev, I.V., Kuznetsov, S.A., Peskov, N.Yu., Phelps, A.D.R., Robertson, C.W., Ronald, K., Sergeev, A.S., Sinitsky, S.L., Stepanov, V.S., Thumm, M., Whyte, C.G., Zaslavsky, V.Yu., 2009, Production of powerful spatially coherent radiation in planar and coaxial exploiting two-dimensional distributed feedback, *IEEE Transactions on Plasma Science*, **37**, 1791-1800.
- [1106] Ginzburg, N.S., Peskov, N.Yu., Sergeev, A.S., Zaslavsky, V.Yu., Arzhannikov, A.V., Kalinin, P.V., Sinitsky, S.L., Stepanov, V.D., Kuznetsov, S.A., Cross, A.W., He, W., Konoplev, I.V., Phelps, A.D.R., Robertson, C.W., Ronald, K., Whyte, C.G., Thumm, M., 2008, Generation of powerful coherent radiation in FEM exploiting two-dimensional distributed feedback, Proc. 7th Int. Workshop on Strong Microwaves: Sources and Applications, Nizhny Novgorod, ed. A.G. Litvak, Inst. of Applied Physics, Russian Academy of Sciences, Nizhny Novgorod, 2009, **Vol. 1**, pp. 154-161.
- [1107] Arzhannikov, A.V., Ginzburg, N.S., Zaslavskii, V.Yu., Ivanenko, V.G., Ivanov, I.A., Kalinin, P.V., Kuznetsov, A.S., Kuznetsov, S.A., Peskov, N.Yu., Sergeev, A.S., Sinitskii, S.L., Stepanov, V.D., 2008, Generation of spatially coherent radiation in free-electron masers with two-dimensional distributed feedback, *JETP Letters*, **87**, 618-622.

- [1108] Ginzburg, N.S., Golubev, I.I., Golubykh, S.M., Zaslavskii, V.Yu., Zotova, I.V., Kaminsky, A.K., Kozlov, A.P., Malkin, A.M., Peskov, N.Yu., Perel'shtein, E.A., Sedykh, S.N., Sergeev, A.S., 2010, Free-electron maser with high-selectivity Bragg resonator using coupled propagating and trapped modes, *Technical Physics Letters*, **36**, 952-956.
- [1109] Ginzburg, N.S., Peskov, N.Yu., Sergeev, A.S., Arzhannikov, A.V., Kalinin, P.V., Sinitsky, S.L., Thumm, M., 2011, Powerful masers and lasers with two-dimensional distributed feedback, *Proc. 8th Int. Workshop Strong Microwaves and Terahertz Waves: Sources and Applications*, Nizhny Novgorod – St. Petersburg, Russia, July 9-16, 2011, pp. 57-58.
- [1110] Sinitsky, S.L., Arzhannikov, A.V., Astrelin, V.T., Ginzburg, N.S., Kalinin, P.V., Kuznetsov, S.A., Peskov, N.Yu., Sergeev, A.S., Stepanov, V.D., Thumm, M., Zaslavsky, V.Yu., 2011, Planar FEM driven by two microsecond sheet e-beams, *Proc. 8th Int. Workshop Strong Microwaves and Terahertz Waves: Sources and Applications*, Nizhny Novgorod – St. Petersburg, Russia, July 9-16, 2011, pp. 131-132.
- [1111] Ginzburg, N.S., Peskov, N.Yu., Sergeev, A.S., Zaslavsky, V.Yu., Arzhannikov, A.V., Kalinin, P.V., Sinitsky, S.L., Thumm, M., 2012, High selective two-dimensional Bragg resonators of planar geometry: theoretical, computational, and experimental study. *J. of Applied Physics*, **112**, 114504/1-12.
- [1112] Ginzburg, N.S., Peskov, N.Yu., Zotova, I.V., Sergeev, A.S., Phelps, A.D.R., Cross, A.W., He, W., Ronald, K., Shpak, V.G., Yalandin, M.I., Shunailov, S.A., Ulmaskulov, M.R., 1999, Experimental observation of wiggler superradiance under group synchronism condition. *Nucl. Instr. Meth. in Phys. Research*, **A 429**, 94-100.
- [1113] Ginzburg, N.S., Sergeev, A.S., Zotova, I.V., Shpak, V.G., Yalandin, M.I., Phelps, A.D.R., Cross, A.W., Wiggins, S.M., Tarakanov, V.P., 1999, Generation of powerful subnanosecond microwave pulses based on superradiance. *Proc. Int. University Conf. "Electronics and Radiophysics of Ultra-High Frequencies" (UHF-99)*, 1999, St. Petersburg, Russia, 194-197.
- [1114] Ginzburg, N.S., Zotova, I.V., Novozhilova, Yu.V., Sergeev, A.S., Phelps, A.D.R., Cross, A.W., Wiggins, S.M., Ronald, K., Shpak, V.G., Yalandin, M.I., Shunailov, S.A., Ulmaskulov, M.R., Tarakanov, V.P., 1999, Superradiance as method of generation of ultrashort microwave pulses. *Proc. 4th Int. Workshop on Strong Microwaves in Plasmas*, Nizhny Novgorod, ed. A.G. Litvak, Inst. of Applied Physics, Russian Academy of Sciences, Nizhny Novgorod, 2000, **Vol. 2**, 787-801.
- [1115] Kaminsky, A.K., Kaminsky, A.A., Sarantsev, V.P., Sedykh, S.N., Sergeev, A.P., Ginzburg, N.S., Peskov, N.Yu., Sergeev, A.S., 1996, High efficiency FEL-oscillator with Bragg resonator operated in reversed guide field regime. *Nucl. Instr. Meth.*, **A375**, 215-218.
- [1116] Ginzburg, N.S., Kaminsky, A.A., Kaminsky, A.K., Peskov, N.Yu., Sedykh, S.N., Sergeev, A.P., Sergeev, A.S., 1996, High-efficiency operation of the JINR-IAP Ka-band FEL-oscillator. *Proc. 3rd Int. Workshop on Strong Microwaves in Plasmas*, Nizhny Novgorod, 1997, Vol.2, 782-790, and, 1998, *Nucl. Instr. Meth.*, **A407**, 167-171.
- [1117] Ginzburg, N.S., Kaminsky, A.K., Kaminsky, A.A., Peskov, N.Yu., Sedykh, S.N., Sergeev, A.P., Sergeev, A.S., 1998, Theoretical and experimental comparison of FEL-oscillators with conventional and reversed guide field. *IEEE Trans. on Plasma Science*, **PS-26**, 536-541.
- [1118] Ginzburg, N.S., Kaminsky, A.K., Kaminsky, A.A., Peskov, N.Yu., Sedykh, S.N., Sergeev, A.P., Sergeev, A.S., 1998, Single-mode and multimode operation conditions in JINR-IAP millimeter-wave FEL-oscillator. *IEEE Trans. on Plasma Science*, **PS-26**, 542-547.
- [1119] Peskov, N.Yu., Ginzburg, N.S., Kaminskii, A.A., Kaminskii, A.K., Sedykh, S.N., Sergeev, A.P., Sergeev, A.S., 1999, High-efficiency narrow-band free-electron maser using a Bragg cavity with a phase discontinuity in the ripples. *Techn. Phys. Lett.*, **25**, 429-432.

- [1120] Ginzburg, N.S., Kaminsky, A.K., Peskov, N.Yu., Sedykh, S.N., Sergeev, A.P., Sergeev, A.S., 1999, Development of high-efficiency FEL-oscillator for feeding high-gradient accelerating structures. Proc. 4th Int. Workshop on Strong Microwaves in Plasmas, Nizhny Novgorod, ed. A.G. Litvak, Inst. of Applied Physics, Russian Academy of Sciences, Nizhny Novgorod, 2000, **Vol. 2**, 815-820.
- [1121] Ginzburg, N.S., Goldenberg C.A., Kaminsky, A.k., Peskov, N.Yu., Sedykh, S.N., Sergeev, A.P., 2000, Millimeter-wave FEL-oscillator with a new type Bragg resonator: advantages in efficiency and selectivity. Nucl. Instr. and Meth. in Phys. Res., **A 445**, 253-256.
- [1122] Ginzburg, N.S., Kaminsky, A.A., Kaminsky, A.K., Peskov, N.Yu., Sedykh, S.N., Sergeev, A.P., Sergeev, A.S., 2000, High-efficiency single-mode free-electron maser oscillator based on a Bragg resonator with step of phase of corrugation. Phys. Rev. Lett., **84**, 3574-3577.
- [1123] Elzhov, A.V., Ganichev, A.V., Ginzburg, N.S., Kaminsky, A.K., Perelstein, E.A., Peskov, N.Yu., Sedykh, S.N., Sergeev, A.P., Sergeev, A.S., 2002, Possible ways of improvement of a FEM-oscillator with bragg resonator, JINR-IAP FEM oscillator with a Bragg resonator: experimental investigation and application. Proc. 5th Int. Workshop on Strong Microwaves in Plasmas, Nizhny Novgorod, ed. A.G. Litvak, Inst. of Applied Physics, Russian Academy of Sciences, Nizhny Novgorod, 2003, **Vol. 1**, 190-194.
- [1124] Elzhov, A.V., Ginzburg, N.S., Ilyakov, E.V., Ivanov, I.N., Kaminsky, A.K., Kosukhin, V.V., Kulagin, I.S., Kuzikov, S.V., Perelstein, E.A., Peskov, N.Yu., Petelin, M.I., Sedykh, S.N., Sergeev, A.P., Sergeev, A.S., Zaitsev, N.I., 2002, JINR-IAP FEM oscillator with a Bragg resonator: experimental investigation and application. Proc. 5th Int. Workshop on Strong Microwaves in Plasmas, Nizhny Novgorod, ed. A.G. Litvak, Inst. of Applied Physics, Russian Academy of Sciences, Nizhny Novgorod, 2003, **Vol. 1**, 184-189.
- [1125] Ginzburg, N.S., Elzhov, A.V., Kaminsky, A.K., Kuzikov, S.V., Peskov, N.Yu., Perelstein, E.A., Sedykh, S.N., Sergeev, A.P., Sergeev, A.S., 2004, Repetitive 30 GHz free-electron maser applicable for RF testing properties of materials. 15th Int. Conf. on High-Power Particle Beams (BEAMS'2004), St. Petersburg, Russia, 139.
- [1126] Peskov, N.Yu., Saviolov, A.V., Kalynov, Yu.K., Kuzikov, S.V., Shchegol'kov, D.Yu., Elzhov, A.V., Kaminsky, A.K., Kozlov, A.P., Perelstein, E.A., Sedykh, S.N., 2006, Progress in development of powerful sub-mm Bragg FEM based on moderately relativistic electron beam. Conf. Digest 31st Int. Conf. on Infrared and Millimeter Waves and 14th Int. Conf. on Terahertz Electronics, Shanghai, China, 573.
- [1127] Peskov, N.Yu., Kaminsky, A.K., Kalynov, Yu.K., Kuzikov, S.V., Kornishin, S.Yu., Perelstein, E.A., Saviolov, A.V., Sedykh, S.N., 2007, Sub-millimeter Bragg FEM based on moderately relativistic electron beam: project and first experiments. Conf. Digest 32nd Int. Conf. on Infrared and Millimeter Waves and 15th Int. Conf. on Terahertz Electronics, Cardiff, UK, 837-838.
- [1128] Akiba, T., Tanaka, K., Mokuno, M., Miyamoto, S., Mima, K., Nakai, S., Kuruma, S., Imasaki, K., Yamanaka, C., Fukuda, M., Ohigashi, N., Tsunawaki, Y., 1990, Helical distributed feedback free-electron laser. Appl. Phys.Lett., **56**, 503-505.
- [1129] Asakawa, M., Sakamoto, N., Inoue, N., Yamamoto, T., Mima, K., Nakia, S., Chen, J., Eujita, M., Imasaki, K., Yamanaka, C., Agari, T., Asakuma, T., Ohigashi, N., Tsunawaki, Y., 1994, Experimental study of a waveguide free-electron laser using the coherent synchrotron radiation emitted from electron bunches. Appl. Phys.Lett. **64**, 1601-1603.
- [1130] Mizuno, T., Ootuki, T., Ohshima, T., Saito, H., 1995, Experimental mode analysis of the circular free electron laser. Nucl. Instr. Meth., **A358**, 131-134.

- [1131] Sakamoto, K., Kishimoto, Y., Watanabe, A., Kobayashi, T., Musyoki, S., Oda, H., Tokuda, S., Nakamura, Y., Kawasaki, S., Ishizuka, H., Sato, M., Nagashima, T., Shiho, M., 1992, MM wave FEL experiment with focusing wiggler, Course and Workshop on High Power Microwave Generation and Applications. Int. School of Plasma Physics, Varenna, 1991, eds., D. Akulina, E. Sindoni, C. Wharton, Editrice Compositori Bologna, 597-604.
- [1132] Sakamoto, K., Kobayashi, T., Kawasaki, S., Kishimoto, Y., Musyoki, S., Watanabe, A., Takahashi, M., Ishizuka, H., Sato, M., Shiho, H., 1994, Millimeter wave amplification in a free electron laser with a focusing wiggler. *J. Appl. Phys.*, **75**, 36-42.
- [1133] Lee, B.C., Kim, S.K., Jeong, Y.U., Cho, S.O., Cha, B.H., Lee, J., 1996, First lasing of the KAERI millimeter-wave free electron laser. *Nucl. Instr. Meth.*, **A375**, 28-31.
- [1134] Jeong, Y.U., Lee, B.C., Kim, S.K., Cho, S.O., Cha, B.H., Lee, J., Kazakevitch, G.M., Vobly, P.D., Gavrilov, N.G., Kubarev, V.V., Kulipanov, G.N., 2002, First lasing of the KAERI compact far-infrared free-electron laser driven by a magnetron-based microtron. *Nucl. Instr. Meth.*, **A475**, 47-50.
- [1135] Jeong, Y.U., Kazakevitch, G.M., Lee, B.C., Kim, S.K., Cho, S.O., Gavrilov, N.G., Lee, J., 2002, Status and prospects of a compact FIR FEL driven by a magnetron-based microtron. *Nucl. Instr. Meth.*, **A483**, 195-199.
- [1136] Ozaki, T., Ebihara, K., Hiramatsu, S., Kimura, Y., Kishiro, J., Monaka, T., Takayama, K., Whittum, D.H., 1992, First result of the KEK X-band free electron laser in the ion channel guiding regime. *Nucl. Instr. Meth.*, **A318**, 101-104.
- [1137] Takayama, K., Kishiro, J., Ebihara, K., Ozaki, T., Hiramatsu, S., Katoh, H., 1994, 1.5 MeV ion-channel guided X-band free-electron laser amplifier. *Conf. Digest 19th Int. Conf. on Infrared and Millimeter Waves*, Sendai, JSAP Catalog No.: AP 941228, 3-4.
- [1138] Takayama, K., Kishiro, J., Ebihara, K., Ozaki, T., Hiramatsu, S., Katoh, H., 1995, Experimental results on the 1.5 MeV ion channel guided X-band free electron laser. *Nucl. Instr. Meth.*, **A358**, 122-125.
- [1139] Saito, K., Takayama, K., Ozaki, T., Kishiro, J., Ebihara, K., Hiramatsu, S., 1996, X-band prebunched FEL-amplifier. *Nucl. Instr. Meth.*, **A375**, 237-240.
- [1140] Takayama, K., Monaka, T., 1996, Ion-channel guided X-band free-electron laser amplifier. *AIP Conference Proceedings*, **No. 356**, 212-232.
- [1141] Taccetti, J.M., Jackson, R.H., Freund, H.P., Pershing, D.E., Granatstein, V.L., 1999, A Ka-band CHI-wiggler free-electron maser: experimental results. *Nucl. Instr. Meth. in Phys. Research*, **A 429**, 116-120.
- [1142] Orzechowski, T.J., Anderson, B.R., Clark, J.G., Fawley, W.M., Paul, A.C., Prosnitz, D., Scharlemann, E.T., Yarema, S.M., Hopkins, D.B., Sessler, A.M., Wurtele, J.S., 1986, High-efficiency extraction of microwave radiation from a tapered-wiggler free-electron laser. *Phys. Rev. Lett.*, **57**, 2172-2175.
- [1143] Allen, S.L., Scharlemann, E.T., *Proc. 9th Int. Conf. on High-Power Particle Beams*, edited by D. Mosher and G. Cooperstein (available from the National Technical Information Service, Springfield, VA22151), 247.
- [1144] Allen, S.L., Lasnier, C.J., Felker, B., Fenstermacher, M., Ferguson, S.W., Fields, S., Hooper, E.B., Hulsey, S., Makowski, M., Moller, J., Meyer, W., Petersen, D., Scharlemann, E.T., Stallard, B., Wood, R., 1993, Generation of high power 140 GHz microwaves with an FEL for the MTX experiment. *Proc. 1993 Particle Accelerator Conf.*, ed. S.T. Corneliussen, IEEE Piscataway, NJ, **Vol. 2**, 1551-1553.
- [1145] Lasnier, C.J., Allen, S.L., Felker, B., Fenstermacher, M.E., Ferguson, S.W., Hulsey, S.D., Hooper, E.B., Jackson, M.C., Makowski, M.A., Meyer, W.H., Moller, J.M., Petersen, D.E., Sampayan, S.E., Stallard, B.W., Fields, W.F., Oasa, K., 1993, Burst mode FEL with the ETA-III induction linac. *Proc. 1993 Particle Accelerator Conf.*, ed. S.T. Corneliussen, IEEE Piscataway, NJ, **Vol. 2**, 1554-1556.

- [1146] Allen, S.L., Brown, M.D., Byers, J.A., Casper, T.A., Cohen, B.I., Cohen, R.H., Fenstermacher, M.E., Foote, J.H., Hooper, E.B., Hoshino, K., Lasnier, C.J., Lopez, P., Makowski, M.A., Marinak, M.M., Meyer, W.H., Moller, J.M., Nevins, W.M., Oasa, K., Oda, T., Odajima, K., Ogawa, T., Ohgo, T., Rice, B.W., Rognlien, T.D., Stallard, B.W., Scharlemann, E.T., Thomassen, K.I., Wood, R.D., 1994, Nonlinear absorption of high power free-electron-laser-generated microwaves at electron cyclotron resonance heating frequencies in the MTX tokamak. *Phys. Rev. Lett.*, **72**, 1348-1351.
- [1147] Allen, S.L., Casper, T.A., Fenstermacher, M.E., Foote, J.H., Hooper, E.B., Hoshino, K., Lasnier, C.J., Lopez, P., Makowski, M.A., Marinak, M.M., Meyer, W.H., Moller, J.M., Oasa, K., Oda, T., Odajima, K., Ogawa, T., Ogo, T., Rice, B.W., Rognlien, T., Stallard, B.W., Thomassen, K.I., Wood, R.D., 1992, Electron cyclotron resonance heating in the microwave tokamak experiment. *Proc. 14th Int. Conf. on Plasma Physics and Controlled Nuclear Fusion Research, Würzburg*, **Vol. 1**, 617-625, (IAEA-CN-56/E-1-4).
- [1148] Hartemann, F., Legorburu, P.P., Chu, T.S., Danly, B.G., Temkin, R.J., Faillon, G., Mourier, G., Trémeau, T., Bres, M., 1992, Long pulse high gain 35 GHz free-electron maser amplifier experiments. *Nucl. Instr. Meth.*, **A318**, 87-93.
- [1149] Chu, T.S., Hartemann, F., Legorburu, P.P., Danly, B.G., Temkin, R.J., Faillon, G., Mourier, G., Trémeau, T., Bres, M., 1992, High-power millimeter-wave Bragg free-electron maser oscillator experiments. *Nucl. Instr. Meth.*, **A318**, 94-100.
- [1150] Conde, M.E., Bekefi, G., 1992, Amplification and superradiant emission from a 33.3 GHz free electron laser with a reversed axial guide magnetic field. *IEEE Trans. Plasma Science*, **20**, 240-244 and *Nucl. Instr. Meth.*, **A318**, 109-113.
- [1151] Volfbeyn, P., Ricci, K., Chen, B., Bekefi, G., 1994, Measurement of the temporal and spatial phase variations of a pulsed free electron laser amplifier. *IEEE Trans. Plasma Science*, **22**, 659-665.
- [1152] Pasour, J.A., Gold, S.H., 1985, Free electron laser experiments with and without a guide magnetic field: a review of millimeter-wave free electron laser research at the NRL. *IEEE J. Quantum Electronics*, **QE-21**, 845-858.
- [1153] Pershing, D.E., Seeley, R.D., Jackson, R.H., Freund, H.P., 1995, Amplifier performance of the NRL ubitron. *Nucl. Instr. Meth.*, **A358**, 104-107.
- [1154] Karbushev, N.I., Mirnov, P.V., Sazhin, V.D., Shatkus, A.D., 1992, Generation of microwave radiation by an intense microsecond electron beam in an axisymmetric wiggler. *Nucl. Instr. Meth.*, **A318**, 117-119.
- [1155] Liu, S., 1992, Recent development of FEL research activities in P.R. China. *Conf. Digest 17th Int. Conf. on Infrared and Millimeter Waves, Pasadena, Proc.*, **SPIE 1929**, 441 and private communication.
- [1156] Chen, J., Wang, M.C., Wang, Z., Lu, Z., Zhang, L., Feng, B., 1991, Study of a Raman free-electron laser oscillator with Bragg reflection resonators. *IEEE J. Quantum Electron.*, **QE-27**, 477-495.
- [1157] Feng, B., Lu, Z., Zhang, L., Wang, M., 1994, Investigation of Raman free-electron lasers with a bifilar helical small-period wiggler. *IEEE J. Quantum Electron.*, **QE-30**, 2682-2687.
- [1158] Boehmer, H., Christensen, T., Camponi, M.Z., Hauss, B., 1990, A long-pulse millimeter-wave free electron maser experiment. *IEEE Trans. Plasma Science*, **PS-18**, 392-398.
- [1159] Chen, J., Zheng, L., Zhang, Y., Yang, Z., 2000, A novel Smith-Purcell FEL. *Int. J. of Infrared and Millimeter Waves*, **21**, 1563-1567.
- [1160] Chen, J., Zheng, L., Zhang, Y., Yang, Z., 2001, A novel smith-purcell free electron laser. *Int. J. Electronics*, **88**, 467-471.
- [1161] Cheng, S., Granatstein, V.L., Destler, W.W., Levush, B., Rodgers, J., Antonsen, T.M., Jr., 1996, Experimental study of high-power, saturated amplification in a sheet-beam-small-period-wiggler FEL. *Nucl. Instr. Meth.*, **A357**, 160-163.

- [1162] Cheng, S., Destler, W.W., Granatstein, V.L., Antonsen, T.M., Jr., Levush, B., Rodgers, J., Zhang, Z.X., 1996, A high-power millimeter-wave sheet beam free-electron laser amplifier. *IEEE Trans. on Plasma Sciences*, **PS-24**, 750-757.
- [1163] Elias, L.R., Ramian, G., Hu, J., Amir, A., 1986, Observation of single mode operation of a free electron laser. *Phys. Rev. Lett.*, **57**, 424-427.
- [1164] Ramian, G., 1992, The new UCSB free-electron lasers. *Nucl. Instr. Meth.*, **A318**, 225-229.
- [1165] Takahashi, S., Ramian, G., Sherwin, M.S., 2009, Cavity dumping of an injection-locked free-electron laser. *Applied Physics Letters*, **95**, 234102-1 – 234102-3.
- [1166] Wiggins, S.M., Whyte, C.G., He, W., Jaroszynski, D.A., Phelps, A.D.R., Cross, A.W., Ronald, K., 1999, Pulse propagation experiments in a free-electron maser. *Conf. Digest 24th Int. Conf. on Infrared and Millimeter Waves*, Monterey, California, USA, TU-E7.
- [1167] Whyte, C.G., Jaroszynski, D.A., Cross, A.W., He, W., Ronald, K., Young, A., Phelps, A.D.R., 2000, Free electron maser amplifier experiments. *Nucl. Instr. and Meth. in Phys. Res.*, **A 445**, 272-275.
- [1168] Whyte, C.G., Cross, A.W., Jaroszynski, D.A., He, W., Ronald, K., Phelps, A.D.R., 2002, Free electron maser amplifier energy recovery experiments. *Proc. 3rd IEEE Int. Vacuum Electronics Conf. (IVEC 2002)*, Monterey, USA, 91-92 and *Proc. 5th Int. Workshop on Strong Microwaves in Plasmas*, Nizhny Novgorod, ed. A.G. Litvak, Inst. of Applied Physics, Russian Academy of Sciences, Nizhny Novgorod, **Vol. 1**, 2003, 275-278.
- [1169] Phelps, A.D.R., Cross, A.W., Jaroszynski, D.A., He, W., Whyte, C., Ginzburg, N.S., Peskov, N.Yu., 1997, A Ka-band Bragg free electron maser oscillator with axial guide magnetic field. *Conf. Digest 22nd Int. Conf. on Infrared and Millimeter Waves*, Wintergreen, Virginia, USA, 17-18.
- [1170] Ginzburg, N.S., Sergeev, A.S., Zotova, I.V., Novozhilova, Yu.V., Peskov, N.Yu., Konoplev, I.V., Phelps, A.D.R., Cross, A.W., Cooke, S.J., Aitken, P., Shpak, V.G., Yalandin, M.I., Shunailov, C.A., Ulmaskulov, M.P., 1997, Experimental observation of superradiance in millimeter-wave band. *Nucl. Instr. Meth.*, **A393**, 352-355.
- [1171] Cross, A.W., Ginzburg, N.S., He, W., Jaroszynski, D.A., Peskov, N.Yu., Phelps, A.D.R., Whyte, C.G., 1998, A 32 GHz Bragg free electron maser (FEM) oscillator with axial guide magnetic field. *Nucl. Instr. Meth.*, **A407**, 181-186.
- [1172] Phelps, A.D.R., Konoplev, I.V., Cross, A.W., He, W., Whyte, C.G., Ronald, K., Ginzburg, N.S., Peskov, N.Yu., Sergeev, A.S., Thumm, M., 2004, Experimental study of a high power free electron maser band on a two-dimensional Bragg cavity. *Proc. 10th Int. Conf. Displays and Vacuum Electronics*, Garmisch-Partenkirchen, ITG-Fachbericht 183, 187-191.
- [1173] Whyte, C.G., Ronald, K., Phelps, A.D.R., Konoplev, I.V., McGrane, P., Cross, A.W., He, W., Robertson, C.W., Ginzburg, N.S., Peskov, N.Yu., Sergeev, A.S., Thumm, M., 2004, Experimental study of a high power free electron maser based on a co-axial two-dimensional bragg cavity. *Proc. 15th Int. Conf. on High-Power Particle Beams (Beams 2004)*, St. Petersburg, Russia, 446-449.
- [1174] Konoplev, I.V., McGrane, P., Ronald, K., Cross, A.W., He, W., Whyte, C.G., Phelps, A.D.R., Robertson, C.W., Speirs, D.C., Ginzburg, N.S., Peskov, N.Yu., Sergeev, A.S., Thumm, M., 2004, Free electron maser experiments based on a coaxial 2D Bragg cavity. *Conf. Digest 29th Int. Conf. on Infrared and Millimeter Waves and 12th Int. Conf. on Terahertz Electronics*, Karlsruhe, Germany, 569-570.
- [1175] McGrane, P., Konoplev, I.V., Cross, A.W., He, W., Phelps, A.D.R., Ronald, K., Whyte, C.G., 2005, Operation of a free-electron maser based on two-dimensional distributed feedback. *Proc. 6th IEEE Int. Vacuum Electronics Conf. (IVEC 2005)*, Noordwijk, The Netherlands, 439-440.

- [1176] Konoplev, I.V., McGrane, P., Ronald, K., Cross, A.W., He, W., Whyte, C.G., Phelps, A.D.R., Robertson, C.W., Speirs, D.C., Ginzburg, N.S., Peskov, N.Yu., Sergeev, A.S., Thumm, M., 2005, Experimental study of a FEM based on a 2D distributed feedback cavity. Conf. Digest 30th Int. Conf. on Infrared and Millimeter Waves and 13th Int. Conf. on Terahertz Electronics, Williamsburg, VA, USA, 499-500.
- [1177] Phelps, A.D.R., Konoplev, I.V., McGrane, P., Cross, A.W., He, W., Whyte, C.G., Ronald, K., Thumm, M.K., Ginzburg, N.S., Peskov, N.Yu., Sergeev, A.S., 2005, Co-axial Ka-band free electron maser using two-dimensional feedback. Proc. 7th Workshop on High Energy Density and High Power RF, AIP Conference Proceedings **807**, 2006, 238-245.
- [1178] Konoplev, I.V., Cross, A.W., Ginzburg, N.S., He, W., McGrane, P., Peskov, N.Yu., Phelps, A.D.R., Robertson, C.W., Ronald, K., Sergeev, A.S., Thumm, M., Whyte, C.G., Zaslavsky, V.Yu., 2005, Study of co-axial free electron maser based on two-dimensional distributed feedback. Proc. 6th Int. Workshop on Strong Microwaves in Plasmas, Nizhny Novgorod, ed. A.G. Litvak, Inst. of Applied Physics, Russian Academy of Sciences, Nizhny Novgorod, 2006, **Vol. 1**, 208-213.
- [1179] Cross, A.W., Konoplev, I.V., He, W., McInnes, P., Phelps, A.D.R., Ronald, K., Whyte, C.G., Robertson, C.W., 2006, First operation of free-electron maser based on a combined two-mirror cavity based on 2D and 1D Bragg structures. Proc. Int. Vacuum Electronics Conference and Int. Vacuum Electron Sources (IVEC/IVESC 2006), Monterey, California, USA, 469-470.
- [1180] Konoplev, I.V., Cross, A.W., Phelps, A.D.R., He, W., Ronald, K., Whyte, C.G., Robertson, C.W., MacInnes, P., Ginzburg, N.S., Peskov, N.Y., Sergeev, A.S., Zaslavsky, V.Y., Thumm, M., 2007, Experimental and theoretical studies of a coaxial free-electron maser based on two-dimensional distributed feedback, Physical Review E, **76**, 056406/1-12.
- [1181] Phelps, A.D.R., Konoplev, I.V., Cross, A.W., MacInnes, P., He, W., Ronald, K., Whyte, C.G., Robertson, C.W., Thumm, M., 2007, Free-electron maser based on two-dimensional distributed feedback. Conf. Digest 32nd Int. Conf. on Infrared and Millimeter Waves and 15th Int. Conf. on Terahertz Electronics, Cardiff, UK, 830-832.
- [1182] Konoplev, I.V., Cross, A.W., Phelps, A.D.R., He, W., Ronald, K., Whyte, C.G., Robertson, C.W., MacInnes, P., Ginzburg, N.S., Peskov, N.Y., Sergeev, A.S., Zaslavsky, V.Y., Thumm, M., 2007, Experimental and theoretical studies of a coaxial free-electron maser based on two-dimensional distributed feedback, Physical Review E, **76**, 056406/1-12.
- [1183] Konoplev, I.V., Cross, A.W., MacInnes, P., He, W., Phelps, A.D.R., Whyte, C.G., Ronald, K., Robertson, C.W., 2008, Free-electron maser based on a cavity with two- and one-dimensional distributed feedback. Applied Physics Letters, **92**, 211501-1 – 211501-3.
- [1184] Cohen, M., Eichenbaum, A., Arbel, M., Ben-Haim, D., Kleinman, H., Draznin, M., Kugel, A., Yacover, I.M., Gover, A., 1995, Masing and single-mode locking in a free-electron maser employing prebunched electron beam. Phys. Rev. Lett., **74**, 3812-3815 and, 1996, Nucl. Instr. Meth., **A375**, 17-20.
- [1185] Abramovich, A., Arensburg, A., Chairman, D., Eichenbaum, A., Draznin, M., Gover, A., Kleinman, H., Merhasin, I., Pinhasi, Y., Sokolowski, J.S., Yakover, Y.M., Cohen, M., Levin, L.A., Shahal, O., Rosenberg, A., Schnitzer, I., Shiloh, J., 1997, Lasing and radiation-mode dynamics in a Van de Graaff accelerator-free-electron laser with an internal cavity. Appl. Phys. Lett., **71**, 3776-3778 and, 1998, Nucl. Instr. Meth., **A407**, 16-20.
- [1186] Abramovich, A., Canter, M., Gover, A., Sokolowski, J., Yakover, Y.M., Pinhasi, Y., Schnitzer, I., Shiloh, J., 1999, High spectral coherence in long-pulse and continuous free-electron laser: Measurements and theoretical limitations. Phys. Rev. Lett., **82**, 5257-5260.
- [1187] Arbel, M., Eichenbaum, A.L., Pinhasi, Y., Lurie, Y., Tecimer, M., Abramovich, A., Kleinman, H., Yakover, I.M., Gover, A., 2000, Super-radiance in a prebunched beam free electron maser. Nucl. Instr. and Meth. in Phys. Res., **A 445**, 247-252.

- [1188] Abramovich, A., Kleinman, H., Eichenbaum, A., Yakover, Y.M., Gover, A., Pinhasi, Y., 2000, Efficiency enhancement of free electron maser oscillator by mode selection with a prebunched electron beam. *Appl. Phys. Lett.*, **76**, 16-18.
- [1189] Van der Slot, P.J.M., Wittemann, W.J., 1993, Energy and frequency measurements on the Twente Raman free-electron laser. *Nucl. Instr. Meth.*, **A331**, 140-143.



Gyrotron oscillators are mainly used as high power millimeter wave sources for electron cyclotron resonance heating (ECRH), electron cyclotron current drive (ECCD), stability control and diagnostics of magnetically confined plasmas for generation of energy by controlled thermonuclear fusion. The maximum pulse length of commercially available 140 GHz, megawatt-class gyrotrons employing synthetic diamond output windows is 30 minutes (CPI and European KIT-CRPP-CEA-TED collaboration). The world record parameters of the European megawatt-class 140 GHz gyrotron are: 0.92 MW output power at 30 min. pulse duration, 97.5% Gaussian mode purity and 44% efficiency, employing a single-stage depressed collector (SDC) for energy recovery. A maximum output power of 1.5 MW in 4.0 s pulses at 45% efficiency was generated with the JAEA-TOSHIBA 110 GHz gyrotron. The Japan 170 GHz ITER gyrotron achieved 1 MW, 800 s at 55% efficiency and holds the energy world record of 2.88 GJ (0.8 MW, 60 min.) and the efficiency record of 57% for tubes with an output power of more than 0.5 MW. The Russian 170 GHz ITER gyrotron achieved 0.9 MW with a pulse duration of 1000 s and 55% efficiency. The prototype tube of the European 2 MW, 170 GHz coaxial-cavity gyrotron for ITER achieved in short pulses the record power of 2.05 MW at 46% efficiency and 96% Gaussian mode purity. Russian gyrotrons for plasma diagnostics or spectroscopy applications deliver $P_{\text{out}} = 40$ kW with $\tau = 40$ μs at frequencies up to 650 GHz ($\eta \geq 4\%$), $P_{\text{out}} = 5.3$ kW at 1 THz ($\eta = 6.1\%$), and $P_{\text{out}} = 0.5$ kW at 1.3 THz ($\eta = 0.6\%$). Gyrotron oscillators have also been successfully used in materials processing. Such technological applications require gyrotrons with the following parameters: $f > 24$ GHz, $P_{\text{out}} = 4\text{-}50$ kW, CW, $\eta > 30\%$. This paper gives an update of the experimental achievements related to the development of high power gyrotron oscillators for long pulse or CW operation and pulsed gyrotrons for various applications. In addition, this work gives a short overview of the present development status of coaxial-cavity multi-megawatt gyrotrons, gyrotrons for technological and spectroscopy applications, relativistic gyrotrons, quasi-optical gyrotrons, fast- and slow-wave cyclotron autoresonance masers (CARMs), gyroklystrons, gyro-TWT amplifiers, gyrotwystron amplifiers, gyro-BWO's, gyropeniotrons, magnicons, gyroharmonic converters, free electron masers (FEMs) and of vacuum windows for such high-power mm-wave sources.