

# Stability Investigation of Combustion Chambers with LES

Balázs Pritz and Martin Gabi

*Karlsruhe Institute of Technology, Department of Fluid Machinery  
Germany*

## 1. Introduction

Our primary energy consumption is supported in 81% by the combustion of fossil energy commodities (IEA, 2010). The demand on energy will grow by about 60% in the near future (Shell, 2008). The efficiency of the combustion processes is crucial for the environment and for the use of the remaining resources. At the Karlsruhe Institute of Technology the long-term project Collaborative Research Centre (CRC) 606: “Non-stationary Combustion: Transport Phenomena, Chemical Reactions, Technical Systems” was founded to investigate the basics of combustion and for the implementations relevant processes coupled to combustion (Bockhorn et al., 2003; SFB 606, 2002).

Modern combustion concepts comprise lean premixed (LP) combustion, which allows for the reduction of the pollutant emissions, in particular oxides of nitrogen ( $\text{NO}_x$ ) (Lefebvre, 1995). Lean premixed combustors are, however, prone to combustion instabilities with both low and high frequencies. These instabilities result in higher emission, acoustical load of the environment and even in structural damage of the system.

A subproject in CRC 606 was dedicated to investigate low frequency instabilities in combustion systems. The main goal of this subproject was to validate an analytical model, which was developed to describe the resonant characteristics of combustion systems consisting of Helmholtz resonator type components (burner plenum, combustion chamber) (Büchner, 2001). The subproject included experimental and numerical investigations as well. The goal of the numerical part was to find a reliable tool in order to predict the damping ratio of the system. The damping ratio is a very important input of the analytical model. The combination of the numerical prediction of the damping ratio and the analytical model enables the stability investigation of a system during the design phase.

In the numerical part Large Eddy Simulation (LES) was used to predict the damping ratio as previous investigations with unsteady Reynolds-averaged Navier-Stokes simulation (URANS) failed to predict the damping ratio satisfactorily (Rommel, 1995). The results of LES showed a very good agreement with the experimentally measured damping ratio. The focus of this chapter is to show results of further numerical investigations, which sheds light on a very important source of self-excited combustion instabilities, and to show how can provide LES the eigenfrequencies of a system.

In this chapter firstly a short description to combustion instabilities is given. After it the experimental and the numerical investigations of the resonant characteristics of the combustion systems will be shown briefly. In these investigations the system was excited

with a sinusoidal mass flow rate at the inlet and the system response was captured at the outlet. Contrarily in the ensuing numerical investigations there is no excitation at the inlet and the system is still pulsating. The source of this pulsation and the consequences will be discussed.

It is important to notice that in these investigations the flow is non-reacting. There is no combustion, thus no flame in the combustion chamber. Hence there is no self-excited thermo-acoustic oscillation. In the subproject of CRC 606 the investigations of the low-frequency oscillations in the range of a few *Hz* up to several 100 *Hz* were focused on the passive parts of the system: the combustion chamber and the burner plenum. The determination of the flame resonant characteristics is the object of other works (Büchner, 2001; Giauque et al., 2005; Lohrmann et al., 2004; Lohrmann & Büchner, 2004, 2005), and also of another subproject within the CRC 606.

It is also important to clarify here that in these investigations the ignition stability of the flame will not be concerned. The combustion instabilities mentioned here are driven by thermo-acoustic self-excited oscillations. If there is no pulsation in the combustion chamber the flame is stable. Furthermore pulse combustors designed for oscillations are also not dealt within this chapter (Reynst, 1961; Zinn, 1996).

On the other hand, if the flow in a combustion system without flame is investigated the mostly used terms to express this are "cold flow", "non-reacting flow" or "isothermal condition". The last one neglects any changes in the temperature of the gas beyond the one occurred by the heat release of the flame. This is however misleading for peoples who do not investigate flames and physically incorrect. The LES results showed temperature changes due to the pulsation nearly 100 K in the exhaust gas pipe, which is then in the range of 10% of the temperature changes produced by the flame.

## 2. Combustion instabilities

It is an indispensable prerequisite for the successful implementation of advanced combustion concepts to avoid periodic combustion instabilities in combustion chambers of turbines and in industrial combustors (Büchner et al., 2000; Külsheimer et al., 1999). For the elimination of the undesirable oscillations it is important to know the mechanisms of feedback of periodic perturbations in the combustion system. If the transfer characteristics of the subsystems (in a simple case burner, flame and chamber) furthermore of the coupled subsystems are known, the oscillation disposition of the combustion system can be evaluated during the design phase for different, realistic operation conditions (desired load range, air ratio, fuel type, fuel quality and temperature).

In order to get a high density of heat release flux i.e. power density and simultaneously low NO<sub>x</sub> emission highly turbulent lean premixed or partially premixed flames are mostly used (Lefebvre, 1995). Significant property of these flames is that any disturbances in the equivalence ratio through turbulence or in the air/fuel mixture supply produce a very fast change in the heat release. Compared to axial jet flames the premixed swirl flames can significantly amplify the disturbances (Büchner & Külsheimer, 1997). The combustion process is increasingly sensitive to perturbation in the equivalence ratio under lean operating conditions.

Unsteady heat release involves pressure and velocity pulsation in the combustion chamber. These can result in thrust/torque oscillation, enhanced heat transfer and thermal stresses to combustor walls and other system components, oscillatory mechanical loads that results in

low- and high-cycle fatigue of system components (Joos, 2006; Lieuwen & Yang, 2005). The oscillation of flow parameters can increase the amplitude of flame movements. This can cause blowoff of the flame or, in worst case, a flashback of the flame into the burner plenum. There are several mechanisms suspected of leading to combustion instabilities, such as periodic inhomogeneities in the mixture fraction, pressure sensitivity of the flame speed and the formation of large-scale turbulent structures.

The coupling of flame and acoustics can produce self-excited thermo-acoustic pulsation. The pulsation will be amplified then to the "limit cycle". Thermo-acoustic or thermal acoustic oscillations (TAO) were observed at first by Higgins in 1777 during his investigation of a "singing flame" (Higgins, 1802). The computation of self-excited thermo-acoustic oscillations began with the investigation of the Rijke-tube in (Lehmann, 1937). A short overview about the history of simulations of TAO is given in (Hantschk, 2000). It shows that most of the investigators wanted to compute oscillations excited by the flame or the system with flames excited by an external force at least. Because of the complexity of the problem many computations could not predict the limit cycle.

Lord Rayleigh proposed for the first time a criterion, which, regardless of the source of the instabilities, describes the necessary condition for instabilities to occur (Rayleigh, 1878). The criterion expresses that a pressure oscillation is amplified if heat is added at a point of maximum amplitude or extracted at a point of minimum amplitude. If the opposite occurs, a pressure oscillation is damped. The mathematical representation of this criterion was first proposed in (Putnam, 1971) as:

$$\int_0^T \tilde{q}(t) \cdot \tilde{p}(t) dt > 0 \quad (1)$$

where  $\tilde{q}$  and  $\tilde{p}$  are the fluctuating parts of the heat release rate and the pressure, respectively,  $t$  is the time and  $T$  is the period of the pulsation. The condition will be satisfied for a given frequency if the phase difference between the heat release oscillation and the pressure oscillation is less than  $\pm 90^\circ$ . Additionally, the amplitude of the pressure oscillation will be amplified if the losses through the damping effects are less than the energy fed into the oscillation. More appropriate forms of the Rayleigh criterion and similar criterions can be found in (Poinsot & Veynant, 2005).

## 2.1 Suppression of combustion-driven oscillations

In combustion systems of highly complex shape there can be more various modes: low frequency bulk mode, transversal, tangential, radial and longitudinal modes. In such a combustion system it is almost impossible today to predict all the unstable operating points. There are more strategies in practice to suppress the combustion oscillations in the unstable operating points. These can be grouped into passive and active control methods.

Passive or static control methods tune the resonance characteristics of the combustion system with additional devices as quarter-wave tube, Helmholtz resonators, sound-absorbing batting, orifice, ports and baffles (Putnam, 1971). Resonators can be placed in the fuel system (Richards & Robey, 2008), in the combustor (Gysling et al., 2000) or in other components. Perforates can be used at the premixer inlet (Tran et al., 2009), which is also an additional resonator to tune the resonant characteristics of the system. Instabilities can also be suppressed by means of injection of aluminium (Heidmann & Povinelli, 1967). Passive or

static control strategies methods are more robust and need a minimum of maintenance. Their disadvantage is that while an unstable operating point is removed, another may arise. An overview about theory and practice of active control methods is given in (Annaswamy & Ghoniem, 2002). Active control methods can be subdivided into open-loop (Richards et al., 2007) and closed-loop design (Kim et al., 2005). Active control is achieved by a sensor in the combustion chamber, which measures frequency and phase of the combustion oscillation. The measured signal is analyzed and a proper periodic response is determined. The response is either an acoustic perturbation (Sato et al., 2007) or a modulation of the fuel injection (Guyot et al., 2008). Active control is able to suppress combustion instabilities substantially and is already in use for numerous practical applications. However, the apparatus is rather expensive and needs continuous maintenance. A failure of the control system can lead to a break down of the combustion system.

Based on the investigations of combustion instabilities (Culick, 1971; Zinn, 1970) there is also an approach to keep off unstable regimes during altering operation conditions. Online prediction of the onset of the combustion instabilities can help the operator to avoid, that the system becoming unstable (Johnson et al., 2000; Lieuwen, 2005; Yi & Gutmark, 2008). This technique is very useful if the ambient conditions vary in wide range e.g. for aircraft gas turbine. For stationary gas turbines with approximately constant ambient conditions, however, this cannot help to design the system for operation conditions, where combustion instabilities are not present.

## 2.2 System analysis

In order to analyse the stability of the system control theory can be used. The combustion system can be divided in subsystems as burner plenum, flame and combustion chamber (Baade, 1974; Büchner, 2001; Lenz, 1980; Priesmeier, 1987). The simplified feedback loop of these subsystems is depicted in Fig. 1. A perturbation of the pressure in the combustion chamber influences the mass flow rate at the burner outlet. This changes the heat release rate of the flame, which results in an alteration of the pressure in the combustion chamber. The transfer function of this closed loop and the subsystems can be determined by system identification furthermore the stability can be investigated by e.g. the Nyquist criterion (Deuker, 1994; Sattelmayer & Polifke, 2003a, 2003b).

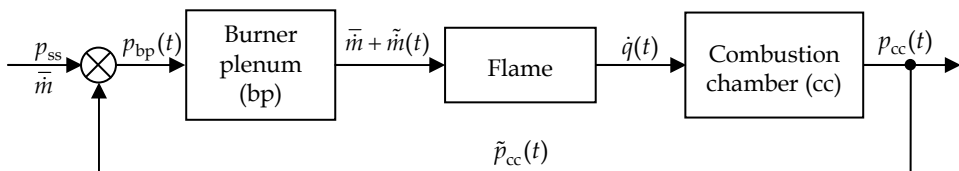

Fig. 1. Feedback loop of a combustion system with mass flow rate, pressure and heat release rate signals

If the system is built from these elements, a thermoacoustic network can be modelled to predict the unstable modes (Bellucci, 2005). Here, however, some information from measurement is needed.

If the phase shift and gain of the components is known the amplification of the pulsation can be predicted by means of the Rayleigh criterion. This shows that the accurate knowledge of

the phase and gain relationship between pressure and heat release oscillation is a key issue to design stable combustion systems.

### 2.3 Helmholtz resonator

Helmholtz resonators are mostly used as passive devices for attenuations of pulsations in combustion systems. Furthermore the resonance behaviour of the combustion system can be described if it bears analogy to this resonator.

If a cavity is coupled to the ambient through a port (Fig. 2), the gas in this system can be forced into resonance if excited with a certain frequency. Such a geometrical configuration is named Helmholtz resonator after Hermann von Helmholtz, who investigated such devices in the 1850s. The port is the resonator neck, the cavity is the resonator.

The mechanical counterpart of the Helmholtz resonator is a mass-spring-damper system (Fig. 2). The gas in the neck acts as the mass, the gas in the cavity acts as the spring. The identification of the damping is more difficult. There are linear and non-linear effects in the flow. Damping is provided by the bulk viscosity during the pressure-volume work, the laminar viscosity in the oscillating boundary layer in the resonator neck, the vortex shedding at the ends of the resonator neck at the inflow and outflow and the dissipation of the kinetic energy through turbulence generation. Which source is dominating in the pulsating flow in the combustion system is discussed in (Pritz, 2010).

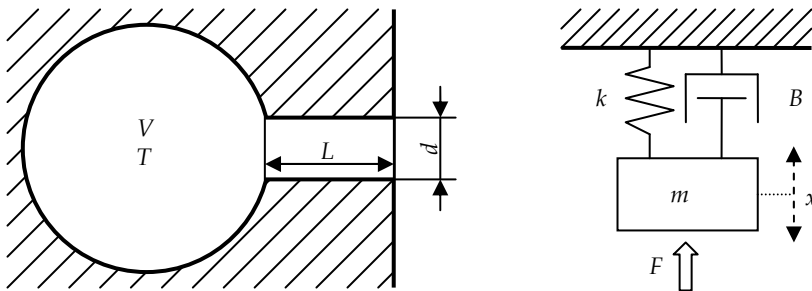

Fig. 2. The Helmholtz resonator and a mass-spring-damper system

The eigenfrequency of the Helmholtz resonator can be predicted as:

$$f_0 = \frac{c}{2 \cdot \pi} \cdot \sqrt{\frac{A}{V \cdot \left( L + \frac{\pi}{4} \cdot d \right)}} \quad (2)$$

where  $c$  is the speed of sound and can be calculated from the temperature  $T$ , the specific heat ratio  $\gamma$  and the specific gas constant  $R$  of an ideal gas as:

$$c = \sqrt{\gamma RT} . \quad (3)$$

Furthermore in Eq. (2)  $d$  is the diameter,  $L$  is the length and  $A$  is the cross section area of the neck,  $V$  is the volume of the resonator. The second term in the parenthesis in the denominator is a length correction term, which can be different for Helmholtz resonators with different geometries.

In order to describe the resonance behaviour of combustion systems, they can be treated as single or coupled Helmholtz resonators. In combustion systems the combustion chamber, the burner plenum or other components with larger volume act as resonators. The exhaust gas pipe and the components coupling the resonator volumes together are resonator necks. In industrial combustors the identification of the components of the Helmholtz resonators is easier, in gas turbines more difficult. It is very important which components are assumed to be coupled and which are decoupled. Wrong assumptions can lead to predicting modes incorrectly or even it is impossible to predict certain modes.

## 2.4 The reduced physical model

The suppression of the combustion oscillations is not a universal solution. The main goal is to design the combustion system not to be prone to combustion instabilities.

For the prediction of the stability of combustion systems regarding the development and maintaining of self-sustained combustion instabilities the knowledge of the periodic-non-stationary mixing and reacting behaviour of the applied flame type and a quantitative description of the resonance characteristics of the gas volumes in the combustion chamber is conclusively needed. In order to describe the periodic combustion instabilities many attempts have been made to assign the dominant frequency of oscillation to the geometry of the combustion chamber. For the description of the geometry-dependent resonance frequency of the system the equations were derived under the assumption of undamped oscillation (e.g.  $\frac{1}{4}$  wave resonator, Helmholtz resonator). These models predict the resonance frequency quite accurate since the shift due to the moderate damping in the system is negligible. Such a simplified model, however, is not applicable for a quantitative prediction of the stability limit of a real combustion system. On one hand it predicts infinite amplification at the resonance frequency. On the other hand the frequency-dependent phase shift between input and output is described by a step function, hence it cannot be used for the application of a phase criterion (Rayleigh or Nyquist criterion), which is used to predict the occurrence of pressure and heat release oscillations in real combustion systems.

A reduced physical model was developed in (Büchner, 2001), which is able to describe the resonance characteristics of combustion chambers, if their geometry satisfies the geometrical conditions of a Helmholtz resonator (Arnold & Büchner, 2003; Büchner, 2001; Lohrmann et al., 2001; Petsch et al., 2005; Russ & Büchner, 2007). The reduced physical model was derived similar to the resonance behaviour of a mass-spring-damper system, which provides a continuous transfer function of the amplification and the phase shift. First the model was developed to describe a single resonator, later it was extended to a coupled system of two resonators. For this reduced physical model scaling laws were developed based on experimental data. The influence of the amplitude of pulsation, the mean mass flow rate, the temperature of the gas and the geometry were investigated.

In this model the damping in the system is expressed by an integral value. The damping factor cannot be determined by analytical solution. The accurate determination of the damping based on the 2<sup>nd</sup> Rayleigh-Stokes problem is not possible because of the complexity and non-linearity of the flow motion in the chamber and in the exhaust gas pipe. It was, however, possible to derive a scaling law for the damping in function of the gas temperature. A scaling law for the dependency of the damping on the length of the exhaust gas pipe could be also derived but its prediction is less accurate (Büchner, 2001).

There is a possibility to determine the integral value of the damping ratio by one measurement e.g. at the resonance frequency predicted by the undamped Helmholtz

resonator model. This is, however, feasible only if the combustion system already exists. In order to determine the value of the damping factor in the design stage numerical simulation should be carried out.

### 3. Resonant characteristics of combustion systems

As mentioned in the Introduction the investigations focused on the passive parts of the system: burner plenum and combustion chamber (including exhaust gas pipe). Here two configurations will be discussed. A single combustion chamber as a single resonator, and a coupled system of burner plenum and combustion chamber as coupled resonators.

#### 3.1 Experimental setup

Former experimental investigations showed that the combustion chamber has specific impact on the stability of the overall system. As first approximation, if the components upstream to the combustion chamber are decoupled by the pressure loss of the coupling element (e.g. burner), the only vibratory component is the combustion chamber, and the system can be treated as a single resonator.

In Fig. 3 the sketch of the experimental setup is shown. In the experiments the transfer function of the combustion chamber was calculated from the input signal measured with the hot-wire probe 1 at the inlet of the chamber and from the output signal measured with the hot-wire probe 2 at the exit cross section of the exhaust gas pipe (Arnold & Büchner, 2003). An alternative output signal was the pressure measured with a microphone probe at the middle of the side wall in the combustion chamber (Büchner, 2001).

The model of the single Helmholtz resonator describes combustion systems sufficiently precise only in a first approximation, since real combustion systems in general have more vibratory gas volumes in addition to the combustion chamber (mixing device, air/fuel supply, burner plenum and exhaust gas system). The linking of these vibratory subsystems results in a significantly more complex vibration behaviour of the overall system compared to the single combustion chamber. To get closer to real combustion systems the model of the single Helmholtz resonator must be extended to describe more resonators coupled to each other.

For modelling a coupled system the burner plenum was added upstream to the combustion chamber. The reduced physical model was extended for the coupled system of burner and combustion chamber (Russ & Büchner, 2007). In order to prove the prediction of the model for the coupled system different geometric parameters (burner volume, resonator geometry) and operating parameters (mean mass flow rate) were varied in the experimental part. In each case the flow was non-reacting. The transfer function was calculated from the input signal (inlet of the burner plenum) and output signal (exit cross section of the exhaust gas pipe) similar to the case of the single resonator. The sketch of the experimental setup and the analogy of a mass-spring-damper system are shown in Fig. 4.

In order to excite the system at different discrete frequencies a pulsator unit was used. This unit could produce a sinusoidal component of the mass flow rate with prescribed amplitude and frequency (Büchner, 2001). For example in the case of the coupled Helmholtz-resonators in Fig. 4 the mean volume flow rate is partially pulsated by the pulsator unit. The pulsating flow passes through the burner plenum (bp), reaches the combustion chamber (cc) through the resonator neck and leaves the system at the end of the exhaust gas pipe (egp).

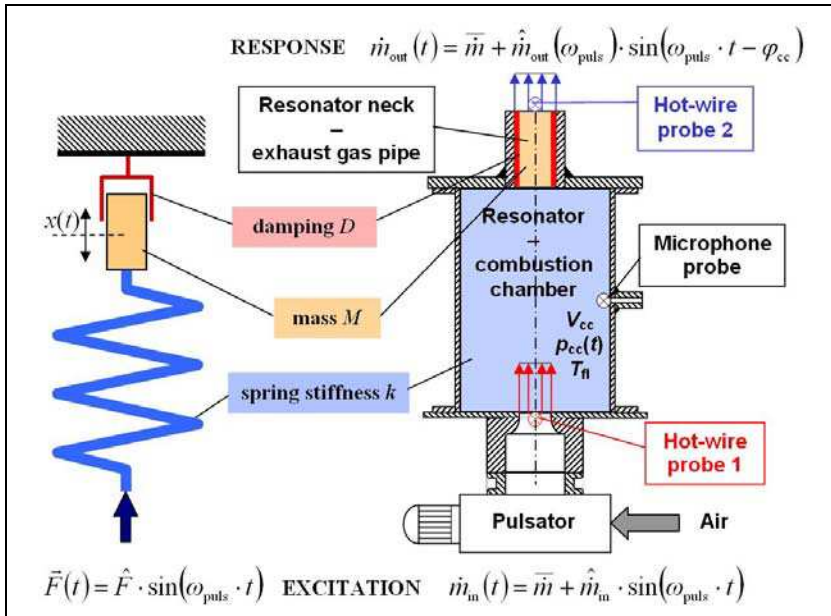

Fig. 3. The sketch of the test rig and the analogy of the mass-spring-damper system and the combustion chamber as Helmholtz resonator

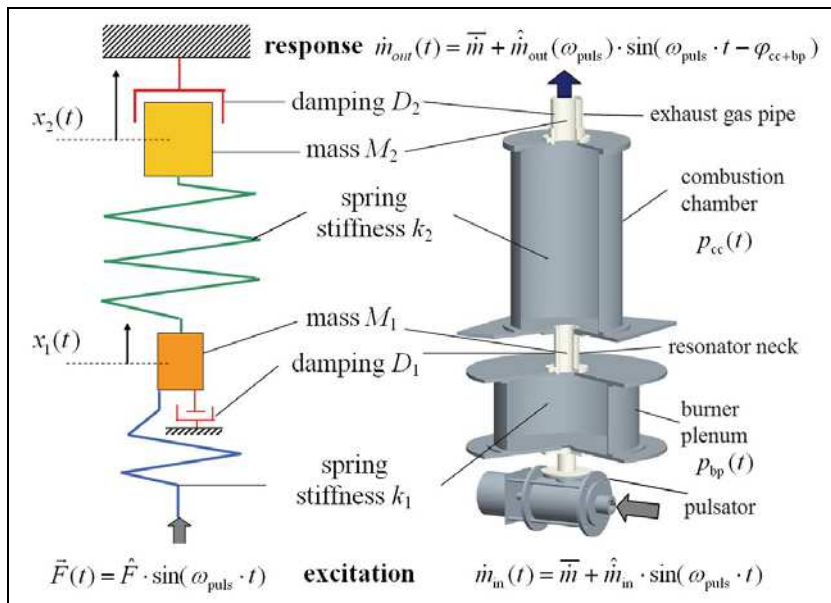

Fig. 4. Coupled Helmholtz-resonators and oscillating masses connected with springs and damping elements



### 3.2 Numerical setup

In order to compute the resonance characteristics of the system a series of LESs at discrete forcing frequencies had to be completed.

In the case of the single resonator these were taken for a basic configuration corresponding to the experiments, for variation of the geometry of the resonator neck and for variation of the fluid temperature. The compressible flow in the chamber of the basic geometry was simulated for five different frequencies in the vicinity of the resonance frequency. A detailed description of the investigated cases is omitted here as it is not in the focus of this chapter and it can be found in (Magagnato et al., 2005).

In the case of the coupled resonators one configuration was investigated. Ten LESs were calculated at different excitation frequencies, because the domain of interest is a broader frequency range than in the case of the single resonator. A detailed description of this investigation can be found in (Pritz et al., 2009).

#### 3.2.1 Numerical method

The main goal of the numerical investigation was to predict the damping coefficient of the system which is an important input for the reduced physical model. In order to provide an insight into the flow mechanics inside the system LES were carried out. LES is an approach to simulate turbulent flows based on resolving the unsteady large-scale motion of the fluid while the impact of the small-scale turbulence on the large scales is accounted for by a sub-grid scale model. By the prediction of flows in complex geometries, where large, anisotropic vortex structures dominate, the statistical turbulence models often fail. The LES approach is for such flows more reliable and more attractive as it allows more insight into the vortex dynamics. In recent years the rapid increase of computer power has made LES accessible to a broader scientific community. This is reflected in an abundance of papers on the method and its applications.

The solution of the fully compressible Navier-Stokes equations was essential to capture the physical response of the pulsation amplification, which is mainly the compressibility of the gas volume in the chamber. Viscous effects play a crucial role in the oscillating boundary layer in the neck of the Helmholtz resonator and, hereby, in the damping of the pulsation. The pulsation and the high shear in the resonator neck produce highly anisotropic swirled flow. Therefore it is improbable that a URANS can render such flow reliably.

The LESs of this system were carried out with the in-house developed parallel flow solver called SPARC (Structured PARallel Research Code) (Magagnato, 1998). The code is based on three-dimensional block structured finite volume method and parallelized with the message passing interface (MPI).

In the case of the combustors the fully compressible Navier-Stokes equations are solved. The spatial discretization is a second-order accurate central difference formulation. The temporal integration is carried out with a second-order accurate implicit dual-time stepping scheme (Zou & Xu, 2000). For the inner iterations the 5-stage Runge-Kutta scheme was used. The time step was  $\Delta t = 2 \cdot 10^{-5} \text{ s}$  and  $\Delta t = 2 \cdot 10^{-6} \text{ s}$  for the single resonator and for the coupled resonators, respectively. This was a compromise in order to resolve the turbulent scales and compute the pulsation cycles within the permitted time. The Smagorinsky-Lilly model was chosen as subgrid-scale model (Lilly, 1967). Later investigations with MILES approach and dynamic Smagorinsky model show no significant difference in the results. This proves that the mesh was sufficiently fine in the regions which are responsible for the damping of the pulsation, thus the modelling of the SGS structures has a minor influence there.

The Full Multigrid (FMG) method is used with four grid levels to achieve faster the statistically stationary state. The FMG method implies grid sequencing and a convergence acceleration technique. The number of cells on a grid level is eight time less then on the next finer grid level.

### 3.2.2 Computational domain and boundary conditions

If the flow in the combustion chamber and the resonator neck has to be simulated (grey area in Fig. 5) attention should be paid to some difficulties by the definition of the boundary conditions.

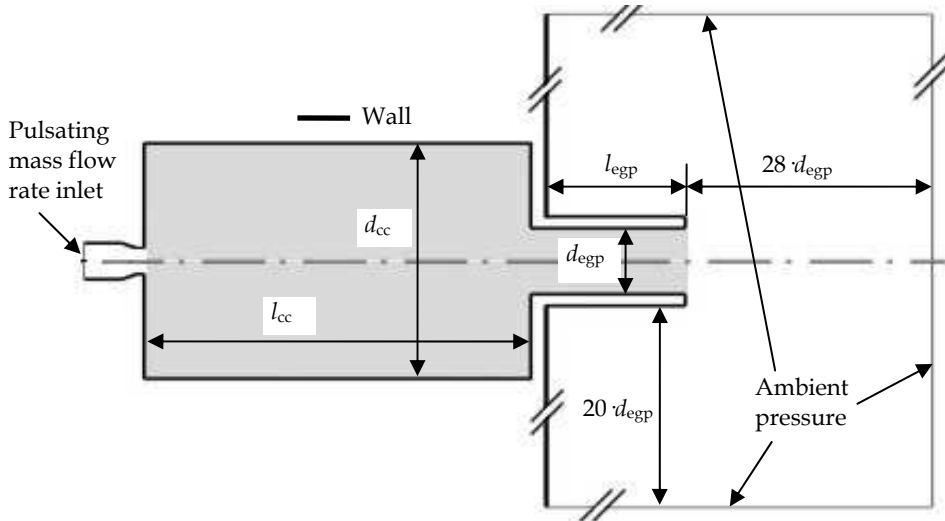

Fig. 5. Sketch of the computational domain and boundary conditions of the single resonator

Even though the geometry of the chamber is axisymmetric no symmetry or periodic condition could be used because the vortices in the flow are three-dimensional and they are mostly on the symmetry axis of the chamber. In the present simulations an O-type grid is used to avoid singularity at the symmetry axis.

At the inflow boundary the fluctuation components should be prescribed for a LES. Furthermore, the boundary must not produce unphysical reflections, if the pressure fluctuations, which move in the chamber back and forth, go through the inlet. A conventional boundary condition can reflect up to 60% of the incident waves back into the flow area. One can avoid these reflections only by the use of a non-reflecting boundary condition. If the inlet would be set at the boundary of the grey area, this problem can be solved hardly. In the experimental investigation a nozzle was used at the inflow into the chamber. The pressure drop of the nozzle ensures that the gas volume in the test rig components upstream of the combustion chamber does not affect the pulsation response of the resonator. It was decided to use this nozzle in the computation also. Although the additional volume of the nozzle increases the number of computing cells, a non-reflecting boundary condition is no more necessary. In addition, the fluctuation components at the inlet can be neglected, since the nozzle decreases strongly the turbulence level downstream.

At the inlet a partially pulsated mass flow rate was prescribed. The rate of pulsation was set to 25%.

The definition of the outflow conditions at the end of the exhaust pipe is particularly difficult. The resolved eddies can produce a local backflow in this cross section occasionally. In particular, by excitation frequencies in the proximity of the resonant frequency there is a temporal backflow through the whole cross section, which has been observed by the experimental investigations as well.

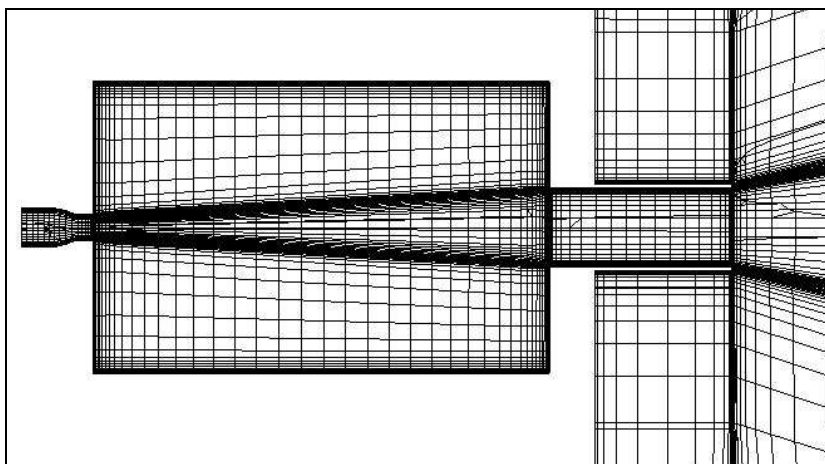

Fig. 6. Third finest mesh extracted to the symmetry plane (distortions were caused by the extraction in Tecplot)

The change of the direction of the flow changes the mathematical character of the set of equations. For compressible subsonic flow four boundary values must be given at the inlet and one must be extrapolated from the flow area. At the outlet one must give one boundary value and extrapolate four others. Since these values are a function of the space and time, their determination from the measurement is impossible. Further the reflection of the waves must be avoided also at the outlet. For these reasons the outflow boundary was set not at the end of the exhaust gas pipe, but in the far field. In order to damp the waves in direction to the outlet boundary mesh stretching was used.

At the solid surfaces the no-slip boundary condition and an adiabatic wall were imposed. For the first grid point  $y^+ < 1$  was obtained, the turbulence effect of the wall was modelled with the van Driest type damping function. The geometry of the computational domain and the boundary conditions are shown in Fig. 5. The entire computational domain contains about  $4.3 \cdot 10^6$  grid points in 111 blocks. A coarsened mesh is shown in Fig. 6.

The definition of the computational domain and the boundary conditions in the case of the coupled resonators were very similar. The geometry of the configuration chosen for the numerical investigation of the coupled resonators is illustrated in Fig. 7. The observation windows (for operations with flame) and the inserted baffle plates increased the complexity of the geometry and hence the generation of the mesh significantly. There were baffle plates placed in the burner plenum and in the combustion chamber to avoid the jet of the nozzle and of the resonator neck to flow directly through the system, furthermore to achieve a

homogeneous distribution of the velocity in the cross-section of the measuring point at the end of the exhaust gas pipe.

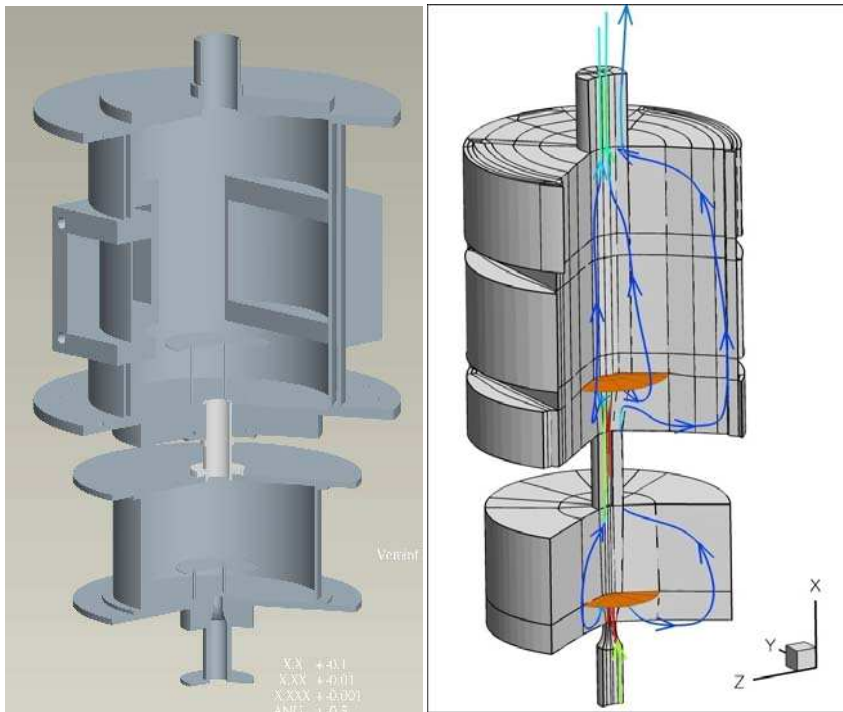

Fig. 7. Geometry of the test rig (left) and the 3D block-structure of the mesh (right)

The outlet boundary had to be modified somewhat compared to the case of the single resonator. The size of this outflow region is  $50 d_{egp}$  in axial direction and  $40 d_{egp}$  in radial direction. At the outlet surface at  $x=5 m$  the static pressure outlet condition is used and the surface is inclined based on the observation explained next (Fig. 8). In order to obtain a statistically steady solution before applying the excitation at the inlet a long time calculation on the multigrid level 4 (coarsest mesh) and 3 was carried out. The entropy waves generated by the transient of the initialization must be advected through the burner plenum and the combustion chamber and finally out of the system. This needed a relative long time as the convection velocity behind the baffle plates is quite small. After the acoustic waves generated also by the transient of the initialization were decayed, it was detected, that acoustic waves of a discrete frequency were amplified to extreme high amplitudes. The wave length coincided with the length of the computational domain. After the outlet surface was slanted these standing waves decayed.

For the distribution of the control volumes a very important aspect was to apply the findings of the investigations of the single resonator. Thus much more computational cells were arranged in the regions of the resonator neck and of the exhaust gas pipe, respectively, and in this case around the baffle plates. The final version of the mesh consists of approx.  $27 \cdot 10^6$  control volumes distributed among 612 blocks.

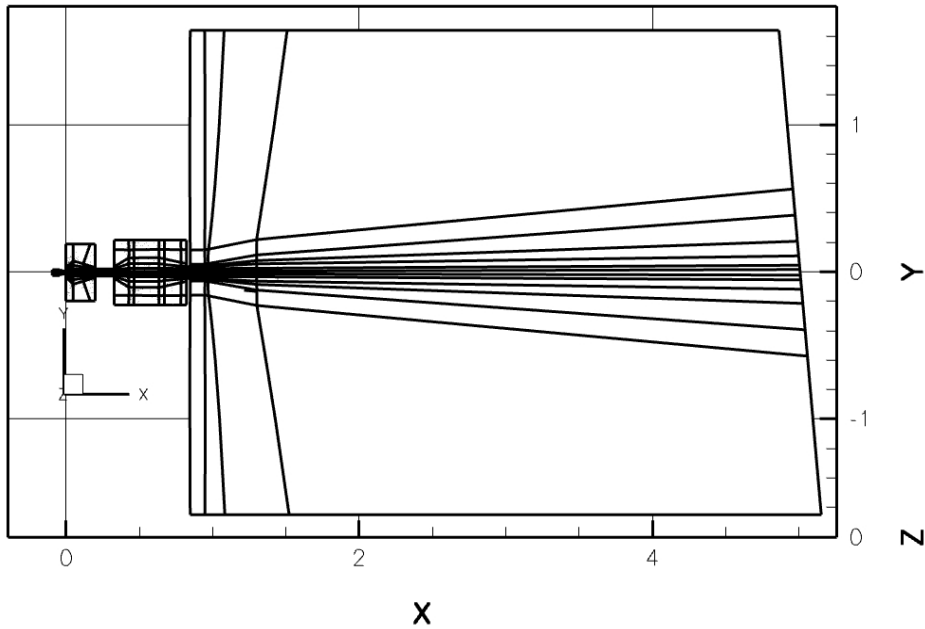

Fig. 8. The computational domain with block structure in the symmetry plane of the coupled resonators

### 3.3 Comparison of the results

The aim of the investigations of the single resonator was to identify the main damping mechanisms and estimate their effect on the stability of the system. In order to get an impression about the flow in the resonators iso-surfaces of the  $Q$ -criterion are plotted in Fig. 9. A detailed investigation of the pulsating flow is shown in (Pritz, 2010).

In this section the resonance characteristics of the combustion chamber obtained from experiments and computations are compared by means of the amplitude and phase transfer functions. The amplitude ratio of the mass flow rates is defined as:

$$A = \frac{\hat{m}_{out}}{\hat{m}_{in}} \quad (4)$$

The amplitude ratios and phase shift were identified in the numerical simulations if the cycle limit was reached.

In Fig. 10 experimental data sets with the analytical model and the results of the computation are exhibited. In one case of the experiments the exhaust pipe was manufactured from a turned steel tube, in the other case the tube was polished. The LES data compare more favourable with the experimental data of polished tube, because the wall in the simulation was aerodynamically smooth, just like the polished resonator neck. The computation predicts the damping factor quite well; the deviation is about 7%. If the results of the measurement of the turned steel tube are compared with the simulation, the deviation is about 40%.

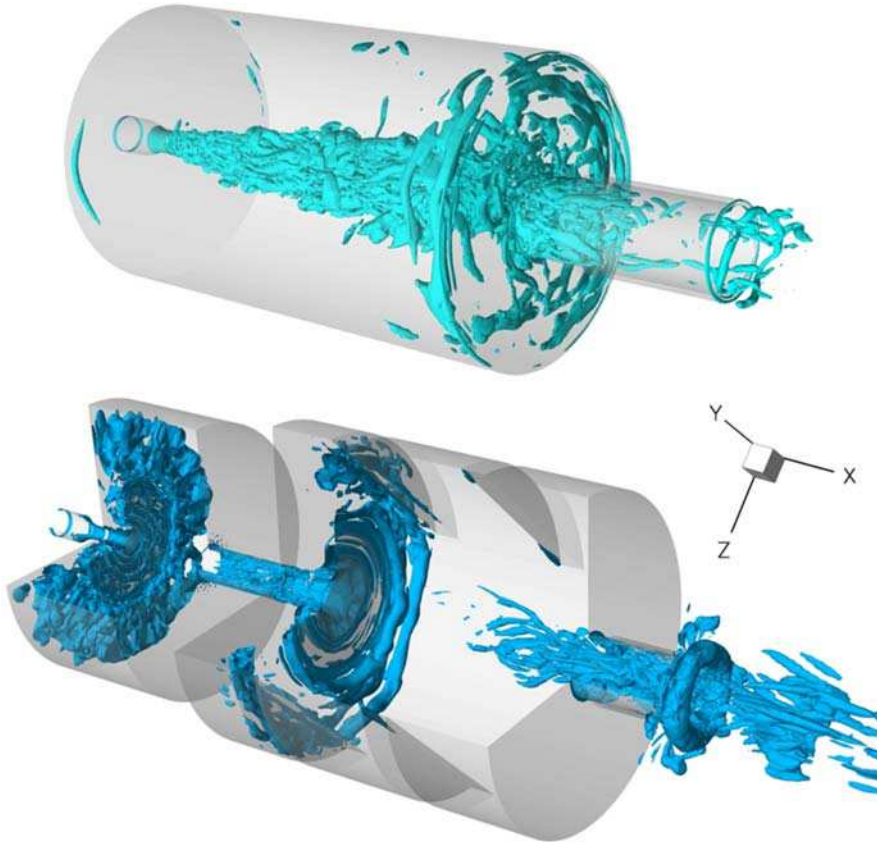

Fig. 9. Flow pattern in the resonators: iso-surfaces of the  $Q$ -criterion at  $5 \cdot 10^4 \text{ s}^{-2}$  in the single resonator (top) and at  $10^4 \text{ s}^{-2}$  in the coupled resonators (bottom)

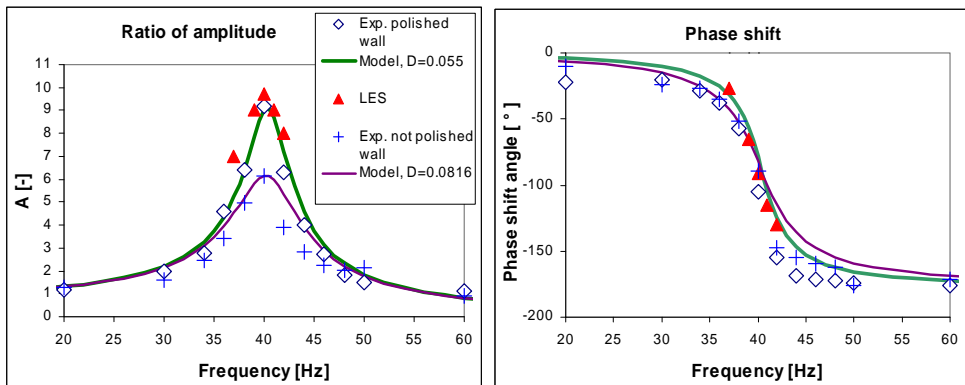

Fig. 10. Amplitude response (left) and phase transfer function (right) of the single resonator

The results of the coupled resonators on different grid levels are plotted in Fig. 11. The difference in the resonance characteristics on the finest and second finest grid is negligible. It was tested only at the lower resonant frequency, at the highest amplitude ratio, because the calculation on the finest mesh was very time consuming. The higher is the amplitude ratio the higher are the demands on the mesh. This result shows that the flow phenomena, which influence the damping, are adequate resolved on the second finest mesh. It is important to take into consideration that the mesh was optimized on the results of the investigation of the single resonator.

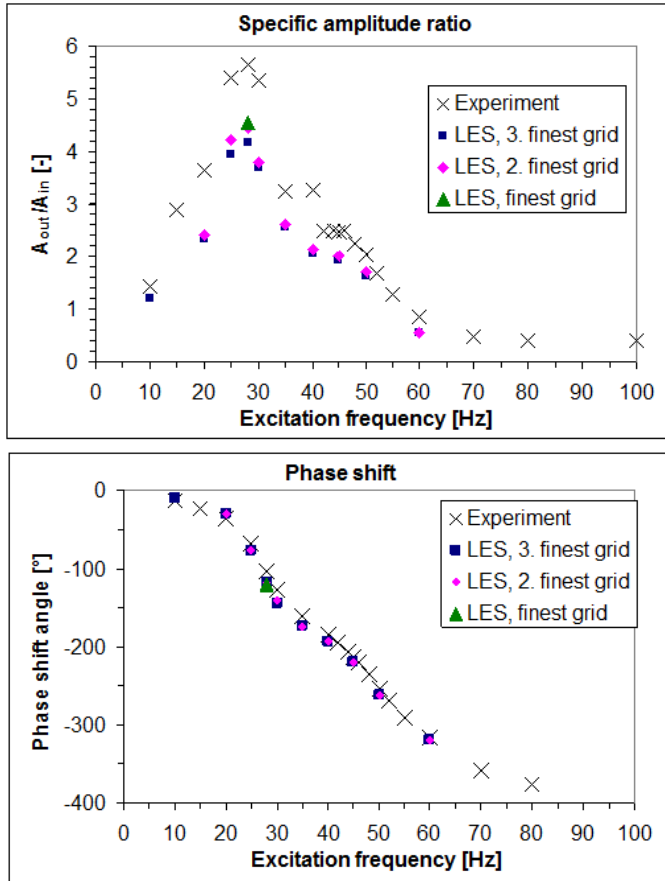

Fig. 11. Amplitude response (top) and phase shift function (bottom) of the coupled resonators

The plotted results in Fig. 11 show generally a very good prediction of the resonance frequencies and of the phase shift, respectively. In the gain, however, there is a discrepancy of approx. 20% in the prediction of the amplitude ratio at the highest peak, at  $f_{ex}=28\text{ Hz}$ . It was mentioned at the experimental setup that baffle plates were implemented in the burner plenum and in the combustion chamber. On these plates the flow is strongly deflected, there

is a significant shearing (see Fig. 9). Unfortunately, in the experiments the plates were perforated. This was necessary to achieve the best velocity distribution at the outlet for the measurement with hot wire. In the simulations the wall condition was used for the plates. The resolution of the holes would yield a tremendous number of grid points. A boundary condition which can model this effect was not available. By the time the geometry data of the configuration were received, it was not possible to replace the plates any more. Probably this difference plays the major role in the underprediction of the amplitude ratio.

#### 4. Investigation without external excitation

In the previous section the resonance characteristics of the system was measured experimentally and predicted numerically. In order to reduce the investigation on a few discrete excitation frequencies the eigenfrequency of the system must be approximated firstly. If the geometry is simple Eq. (2) can be used. In order to determine the amplification and the phase shift of the system well defined excitation had to be prescribed. Therefore a partially pulsated mass flow rate with a prescribed frequency near to the eigenfrequency was used in the numerical simulation at the inlet. In this section the simulations were carried out with a constant mass flow rate at the inlet.

The experiences of the investigations showed that the transient waves generated at the start of the computation should be decayed before the excitation with given amplitude and frequency was started. This was necessary to get the real system response at the outlet. A calculation was initialized with homogeneous distribution of each variable. This produces quite strong transient waves. The mass flow rate signal at the outlet of the exhaust gas pipe was used to monitoring the decaying of these waves. As soon as an almost constant mass flow rate was reached the computation could be continued on the second coarsest grid level. The extrapolation of the solution from the coarser on the next finer grid level produces also transient waves because of the sudden change of the shear stress at the walls. These waves are much smaller than the waves generated at the initialization but they are still considerable on the second coarsest grid level. The mass flow rate signal at the outlet of the exhaust gas pipe showed the decaying of these waves but later a certain amount of pulsation was observed and it decayed not at all. The amplitude of this pulsation was not negligible. As the mass flow rate was computed through integration over the whole cross section of the exhaust gas pipe the turbulent fluctuations were mostly filtered out.

At the description of the computational domain it was mentioned that the outlet boundary in the case of the coupled resonators had to be inclined to eliminate standing waves. These standing waves produced a dominant pulsation with large amplitude in the mass flow rate signal therefore the identification of the frequency was relative simple. In the case of the single resonator the computation was shorter so the standing waves were not amplified to a noticeable value. In the mass flow rate signal the frequency of the dominating wave was approximately at the eigenfrequency of the combustion chamber. In order to analyze this signal better the computation without excitation at the inlet was continued to get enough sample for a Fourier transformation.

The frequency spectrum plotted in Fig. 12 was computed from the mass flow rate signal on the second finest and finest mesh. For this computation the time step was increased to  $\Delta t=10^{-4}$  s, to a relative high value to get a better resolution of the spectra in the low frequency range. The samples were taken in each time step, thus the sampling frequency was 10 kHz furthermore the sampling length was 32768. The peak at 39 Hz agrees very good



with the response function of the combustion chamber in Fig. 10. Recent investigations showed that the resonance frequency can be captured already on the coarsest grid level and the signal of the solution on the second coarsest grid can already predict the resonance frequency quite accurately.

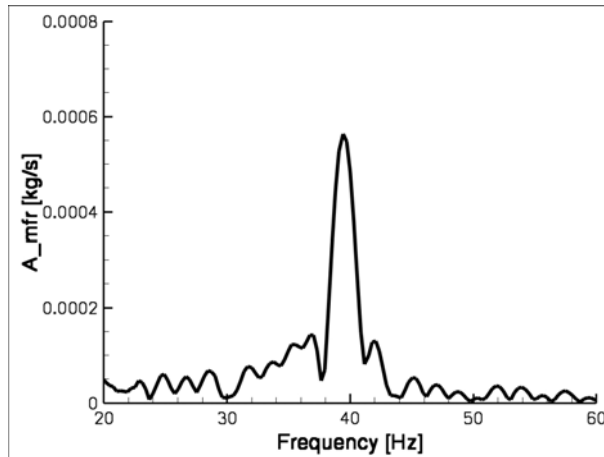

Fig. 12. Frequency spectrum of the outlet mass flow rate of the single resonator

It was shown in (Büchner, 2001) that the mass flow rate signal at the outlet and the pressure signal in the combustion chamber can be used as output signal equivalently i.e. the pulsation of the mass flow rate indicates a pulsation of the pressure in the chamber. The Fourier transform of the pressure signal measured at the middle of the side wall of the chamber gives the same result.

The mass flow rate at the inlet for this calculation was kept on a constant value. There was no external excitation in this computation and no turbulence at the inlet was described. The only possible forcing of the pulsation could arise from the turbulent motions inside the combustion chamber. The inflow into the chamber is a jet with strong shear layer which generates a broad band spectrum of turbulent fluctuations (Fig. 9). The combustion chamber then amplifies the pressure fluctuations generated by the turbulence at its eigenfrequency.

In order to investigate the effect of periodic flow instabilities further calculations with different mass flow rate at the inlet were carried out. It was changed to 200% and to 80% of the original value, respectively. The spectra of the mass flow rate of these calculations gave the same distribution in the low frequency range except the amplitude of the pulsation was changing proportional to the mean mass flow rate.

Based on these results the mass flow rate signal in the case of the coupled resonators was also investigated. In Fig. 13 the frequency spectrum of the mass flow rate signal on the second finest mesh is exhibited. The peaks at 27 Hz and 54 Hz correspond with the eigenfrequencies of the coupled system, which can be read e.g. from Fig. 11 at the phase shift angle 90° and 270°, respectively.

There are some possible mechanisms listed in the literature, which could trigger self-excited instabilities in combustion systems, but they are not sufficiently understood (Büchner, 2001; Joos, 2006; Poinot & Veynant, 2005; Reynst, 1961). An important achievement of these simulations is that the pressure in the combustion chamber can pulsate already without any

external excitation e.g. compressor or other incoming disturbances from ambient or even periodic flow instabilities depending on the design of the burner. Thus the flame is also pulsating. The amplitude of this pulsation will be amplified to the limit cycle if the time lag of the flame changed so that the pressure fluctuation and the heat release fluctuation meet the Rayleigh criterion.

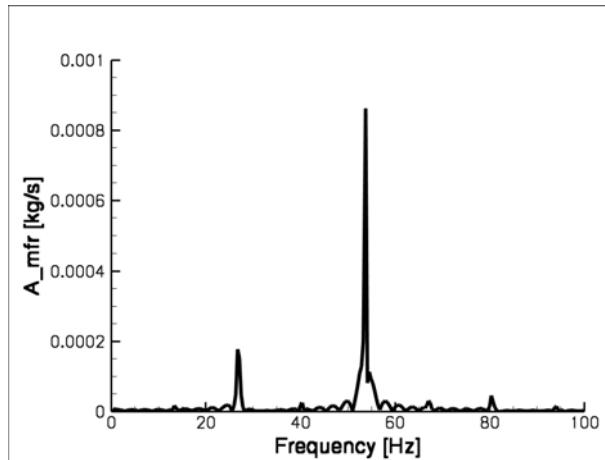

Fig. 13. Frequency spectrum of the outlet mass flow rate of the coupled resonators

The results of the earlier investigations show that the pulsation and the high shear in the resonator neck produce highly anisotropic swirled flow. Therefore it is unlikely that a URANS simulation can render such flow reliably. Furthermore if the turbulence is modelled statistically, it cannot excite the flow in the combustion chamber. The use of LES for the investigation of combustion instabilities is essential.

For the analytical model the eigenfrequency of the system is an important input parameter. If the geometry is rather simple the undamped Helmholtz resonator model can be used. Further important achievement of the present computations is that the eigenfrequency of the system with geometry of high complexity can be predicted without an additional modal analysis. The calculation with constant mass flow rate is a preparation for the investigation with excitation at the inlet. As the amplitude of the excitation is not well defined in the former case only the latter calculation can provide the damping ratio for the analytical model.

## 5. Conclusion

The lean premixed combustion allows for reducing the production of thermal  $\text{NO}_x$ , therefore it is largely used in stationary gas turbines and for other industrial combustion. Lean premixed combustors are, however, prone to combustion instabilities with both low and high frequencies. For the prediction of the stability of technical combustion systems the knowledge of the periodic-non-stationary mixing and reacting behaviour of the applied flame type and a quantitative description of the resonance characteristics of the gas volumes in the combustion chamber is conclusively needed.

In this chapter the numerical investigation of the non-reacting flow in a Helmholtz resonator-type model combustion chamber and in a coupled system of burner and combustion chamber is presented briefly. The work was a part of series of investigations to determine the stability limits of combustion systems. The resonance characteristics of the combustion systems were calculated using Large Eddy Simulation. The results are in good agreement with the experimental data and a reduced physical model, which was developed to describe the resonant behaviour of a damped Helmholtz resonator-type combustion chamber (Büchner, 2001).

The solution of the fully compressible Navier-Stokes equations was essential to capture the physical response of the pulsation amplification, which is mainly the compressibility of the gas volume in the chamber. Viscous effects play a crucial role in the oscillating boundary layer in the neck of the Helmholtz resonator and, hereby, in the damping of the pulsation. The pulsation and the high shear in the resonator neck produce highly anisotropic turbulent flow. Therefore it is improbable that an URANS simulation can render such flow reliably.

The investigation of the case without external excitation showed that the frequency spectrum of the mass flow rate signal at the outlet of the exhaust gas pipe provides a peak at the eigenfrequency of the combustion chamber. The only possible forcing of this pulsation was the turbulent fluctuations generated by the jet in the combustion chamber. The broadband excitation of the turbulent flow can be amplified by the flame and can produce a broadband background heat release rate oscillation as detected also in (Yi & Gutmark, 2008). If the eigenfrequency of the combustion chamber or other vibratory component is in the range of the frequencies of the energetic turbulent eddies a dominant pulsation can occur. The amplitude of this pulsation will be amplified to the limit cycle if the time lag of the flame changed so that the pressure fluctuation and the heat release fluctuation meet the Rayleigh criterion. If the turbulence is modelled statistically (URANS), it cannot excite the flow in the combustion chamber. The use of LES for the investigation of combustion instabilities is essential.

## 6. Acknowledgment

The present work was a part of the subproject A7 of the Collaborative Research Centre (CRC) 606 - "Unsteady Combustion: Transportphenomena, Chemical Reactions, Technical Systems" at the Karlsruhe Institute of Technology. The project was supported by the German Research Foundation (Deutsche Forschungsgemeinschaft - DFG). We also acknowledge support by DFG and Open Access Publishing Fund of Karlsruhe Institute of Technology. The calculations have been performed using the HP XC4000 of the Steinbuch Centre for Computing (SCC) in Karlsruhe.

## 7. References

- Annaswamy, A.M., Ghoniem, A.F. (2002). Active Control of Combustion Instability: Theory and Practice, *IEEE Control Systems Magazine*, Vol.22, Nr.6, pp. 37-54
- Arnold, G., Büchner, H. (2003). Modelling of the Transfer Function of a Helmholtz-Resonator-Type combustion chamber, *Proceedings of the European Combustion Meeting 2003 (ECM2003)*, Orléans, France
- Baade, P. (1974). Selbsterregte Schwingungen in Gasbrennern, *Klima- + Kälteingenieur*, Nr. 4/74, Teil 6, pp. 167-176

- Bellucci, V., Schuermans, B., Nowak, D., Flohr, P., Paschereit, C.O. (2005). Thermoacoustic Modeling of a Gas Turbine Combustor Equipped with Acoustic Dampers, *Journal of Turbomachinery*, Vol.127, Nr.2, pp. 372-379
- Bockhorn, H.; Fröhlich, J.; Sutz, R. (2003). SFB606 - a German Research Initiative on Unsteady Combustion, *ERCOFTAC Bulletin*, Vol.59, pp. 40-44
- Büchner, H. (2001). *Strömungs- und Verbrennungsinstabilitäten in technischen Verbrennungssystemen*, professorial dissertation, University of Karlsruhe, Germany
- Büchner, H., Bockhorn, H., Hoffmann, S. (2000). Aerodynamic Suppression of Combustion-Driven Pressure Oscillations in Technical Premixed Combustors, *Proceedings of Symposium on Energy Engineering in the 21st Century (SEE 2000)*, Hong Kong, China, Ping Cheng (Ed.), Begell House, New York, Vol.4, pp.1573-1580
- Büchner, H., Külsheimer, C. (1997). Untersuchungen zum frequenzabhängigen Mischungs- und Reaktionsverhalten pulsierender, vorgemischter Drallflammen, *GASWÄRME International*, Vol.46, Nr.2, pp. 122-129
- Culick, F.E.C. (1971). Nonlinear Growth and Limiting Amplitude of Acoustic Oscillations in Combustion Chambers, *Combustion Science and Technology*, Vol.3, Nr.1, pp. 1-16
- Deuker, E. (1994). *Ein Beitrag zur Vorausberechnung des akustischen Stabilitätsverhaltens von Gasturbinenbrennkammern mittels theoretischer und experimenteller Analyse von Brennkammerschwingungen*, PhD thesis, Universität of RWTH Aachen, Germany
- Giauque, A., Selle, L., Gicquel, L., Poinot, T., Büchner, H., Kaufmann, P., Krebs, W. (2005). System Identification of a Large-Scale Swirled Partially Premixed Combustor Using LES and Measurements, *Journal of Turbulence*, Vol.6, N 21
- Guyot, D., Taticchi Mandolini Borgia, P., Paschereit, C.O. (2008). Active Control of Combustion Instability Using a Fluidic Actuator, *Proceedings of the 46th AIAA Aerospace Sciences Meeting and Exhibit*, 7-10 January 2008, Reno, Nevada, USA, AIAA 2008-1058
- Gysling, D.L., Copeland, G.S., McCormick, D.C., Proscia, W.M. (2000). Combustion System Damping Augmentation with Helmholtz Resonators. *ASME Journal of Engineering for Gas Turbines and Power*, Vol.122, Nr.2, pp. 269-275
- Hantschk, C.-C. (2000). *Numerische Simulation selbsterregter thermoakustischer Schwingungen*, Fortschritt-Berichte VDI, Reihe 6, Nr. 441
- Heidmann, M. F., Povinelli, L. A. (1967). An Experiment on Particulate Damping in a Two-Dimensional Hydrogen-Oxygen Combustor. *NASA TM X-52359*
- Higgins, B. (1802). On the Sound Produced by a Current of Hydrogen Gas Passing Through a Tube, *Journal of Natural Philosophy, Chemistry and the Arts*, Vol.1, pp. 129-131
- International Energy Agency, *Key World Energy Statistics 2010*, [www.iea.org](http://www.iea.org)
- Johnson, C.E., Neumeier, Y., Lieuwen, T., Zinn, B.T. (2000). Experimental Determination of the Stability Margin of a Combustor Using Exhaust Flow and Fuel Injection Rate Modulations, *Proceedings of the Combustion Institute*, Vol.28, pp. 757-764
- Joos, F. (2006). *Technische Verbrennung*, Springer, Berlin. ISBN-13 978-3-540-34333-2
- Kim, K., Jones, C.M., Lee, J.G., Santavicca, D.A. (2005). Active Control of Combustion Instabilities in Lean Premixed Combustors, *Proceedings of the 6th Symposium on Smart Control of Turbulence*, Tokyo, Japan
- Külsheimer, C., Büchner, H., Leuckel, W., Bockhorn, H., Hoffmann, S. (1999). Untersuchung der Entstehungsmechanismen für das Auftreten periodischer

- Druck-/Flamme-schwingungen in hochturbulenten Verbrennungssystemen, *VDI-Berichte* 1492, pp. 463
- Lefebvre, A.H. (1995). The Role of Fuel Preparation in Low-Emission Combustion, *ASME Journal of Engineering for Gas Turbines and Power*, Vol.117, pp. 617-665
- Lehmann, K.O. (1937). Über die Theorie der Netztöne (thermisch erregte Schallschwingungen), *Annalen der Physik*, Vol.421, Nr.6, pp. 527-555
- Lenz, W. (1980). *Die dynamischen Eigenschaften von Flammen und ihr Einfluss auf die Entstehung selbsterregter Brennkammerschwingungen*, PhD thesis, University of Karlsruhe, Germany
- Lieuwen, T.C. (2005). Online Combustor Stability Margin Assessment Using Dynamic Pressure Data, *Journal of Engineering for Gas Turbines and Power*, Vol.127, Nr.3, pp. 478-482
- Lieuwen, T.C., Yang, V. (2005). *Combustion Instabilities in Gas Turbine Engines*, AIAA, ISBN-13 978-1-56347-669-3
- Lilly, D. K. (1967). The Representation of Small-Scale Turbulence in Numerical Simulation Experiments. In *Proceedings of the IBM Scientific Computing Symposium on Environmental Sciences*, Yorktown Heights, N.Y., IBM form no. 320-1951, White Plains, New York, pp. 195-210
- Lohrmann, M., Arnold, G., Büchner, H. (2001). Modelling of the Resonance Characteristics of a Helmholtz-Resonator-Type Combustion Chamber with Energy Dissipation, *Proceedings of the International Gas Research Conference (IGRC)*, Amsterdam, Netherlands
- Lohrmann, M., Bender, C., Büchner, H., Zarzalis, N. (2004) Scaling of Stability Limits by Use of Universal Flame Transfer Functions, *Proceedings of the Joint Congress CFA/DAGA'04*, Vol.2, Strasbourg, France
- Lohrmann, M., Büchner, H. (2005). Prediction of Stability Limits for LP and LPP Gas Turbine Combustors, *Combustion Science and Technology*, Vol.177, Nr.12, pp. 2243-2273
- Lohrmann, M., Büchner, H. (2004). Scaling of Stability Limits of Lean-Premixed Gas Turbine Combustors, *Proceedings of ASME Turbo Expo*, Wien, Austria
- Magagnato, F. (1998). KAPPA - Karlsruhe parallel program for aerodynamics. *TASK Quarterly*, Vol.2, pp. 215-270
- Magagnato, F., Pritz, B., Büchner, H., Gabi, M. (2005). Prediction of the Resonance Characteristics of Combustion Chambers on the Basis of Large-Eddy Simulation, *International Journal of Thermal and Fluid Sciences*, Vol.14, Nr.2, pp. 156-161
- Petsch, O., Pritz, B., Magagnato, F., Büchner, H. (2005). Untersuchungen zum Resonanzverhalten einer Modellbrennkammer vom Helmholtz-Resonator-Typ, *Verbrennung und Feuerungen - 22. Deutscher Flammentag*, VDI-GET, VDI-Berichte Nr. 1888, pp. 507-512
- Poinsot, T., Veynant, D. (2005). *Theoretical and Numerical Combustion*, R.T. Edwards, Inc., Philadelphia, 2nd Edition, ISBN 1-930217-10-2
- Priesmeier, U. (1987). *Das dynamische Verhalten von Axialstrahl-Diffusionsflammen und dessen Bedeutung für selbsterregte Brennkammerschwingungen*, PhD thesis, Universität of Karlsruhe, Germany
- Pritz, B. (2010). *LES of the Pulsating, Non-Reacting Flow in Combustion Chambers*, SVH, ISBN 978-3-8381-1304-3, Saarbrücken, Germany

- Pritz, B., Magagnato, F., Gabi, M. (2009). Stability Analysis of Combustion Systems by Means of Large Eddy Simulation, *Proceedings of Conference on Modelling Fluid Flow (CMFF'06), The 14<sup>th</sup> International Conference on Fluid Flow Technologies*, Budapest, Hungary
- Putnam, A.A. (1971). *Combustion-Driven Oscillations in Industry*. American Elsevier, New York, USA
- Rayleigh, J.W.S. (1878). *The Theory of Sound*, Volume 2. Macmillan, London, Kingdom of Great Britain
- Reynst, F.H. (1961). *Pulsating Combustion*, Edited by M.W. Thring, Pergamon Press, Oxford, United Kingdom
- Richards, G.A., Thornton, J.D., Robey, E.H., Arellano, L. (2007). Open-Loop Active Control of Combustion Dynamics on a Gas Turbine Engine. *Journal of Engineering for Gas Turbines and Power*, Vol.129, Nr.1, pp. 38-48
- Richards, G.A., Robey, E.H. (2008). Effect of Fuel System Impedance Mismatch on Combustion Dynamics, *Journal of Engineering for Gas Turbines and Power*, Vol.130, Nr.1, 011510
- Rommel, D. (1995). *Numerische Simulation des instationären, turbulenten und isothermen Strömungsfeldes in einer Modellbrennkammer*, master thesis, Engler-Bunte-Institute, University of Karlsruhe, Germany
- Russ, M., Büchner, H. (2007). Berechnung des Schwingungsverhaltens gekoppelter Helmholtz-Resonatoren in technischen Verbrennungssystemen, *Verbrennung und Feuerung*, VDI-Berichte zum 23. Deutscher Flammentag
- Sato, H., Nishidome, C., Kajiwara, I., Hayashi, A.K. (2007). Design of Active Control System for Combustion Instability Using H<sup>2</sup> Algorithm. *International Journal of Vehicle Design*, Vol.43, pp. 322-340
- Sattelmayer, T., Polifke, W. (2003a). A Novel Method for the Computation of the Linear Stability of Combustors, *Combustion Science and Technology*, Vol.175, Nr.3, pp. 477-497
- Sattelmayer, T., Polifke, W. (2003b). Assessment of Methods of the Computation of the Linear Stability of Combustors, *Combustion Science and Technology*, Vol.175, Nr.3, pp. 453-476
- Tran, N., Ducruix, S., Schuller, T. (2009). Damping Combustion Instabilities with Perforates at the Premixer Inlet of a Swirled Burner, *Proceedings of the Combustion Institute*, Vol.32, pp. 2917-2924
- Shell (2008). *Energy Scenarios to 2050*, Shell International BV, Amsterdam 2008, [www.shell.com/scenarios](http://www.shell.com/scenarios)
- SFB 606 (2002). [www.sfb606.kit.edu](http://www.sfb606.kit.edu)
- Yi, T., Gutmark, E.J. (2008). Online Prediction of the Onset of Combustion Instability Based on the Computation of Damping Ratios, *Journal of Sound and Vibration*, Vol.310, pp. 442-447
- Zinn, B.T. (1996). Pulse Combustion Applications: Past, Present and Future, In: *Unsteady Combustion*, Culick F. et al., (Ed.), NATO ASI Series, Vol.306, pp. 113-137
- Zinn, B.T., Powell, E.A. (1970). Nonlinear Combustion Instabilities in Liquid Propellant Rocket Engines, *Proceedings of the Combustion Institute*, Vol.13, pp. 491-502
- Zou, Z., Xu, L. (2000). Prediction of 3-D Unsteady Flow Using Implicit Dual Time Step Approach. *Acta Aeronautica et Astronautica Sinica*, Vol.21, Nr.1, pp 317-321

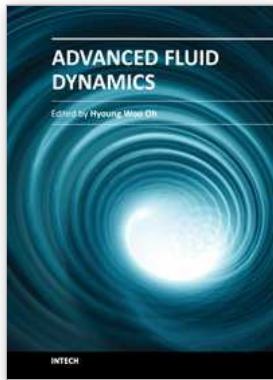

## **Advanced Fluid Dynamics**

Edited by Prof. Hyoung Woo Oh

ISBN 978-953-51-0270-0

Hard cover, 272 pages

**Publisher** InTech

**Published online** 09, March, 2012

**Published in print edition** March, 2012

This book provides a broad range of topics on fluid dynamics for advanced scientists and professional researchers. The text helps readers develop their own skills to analyze fluid dynamics phenomena encountered in professional engineering by reviewing diverse informative chapters herein.

### **How to reference**

In order to correctly reference this scholarly work, feel free to copy and paste the following:

Balázs Pritz and Martin Gabi (2012). Stability Investigation of Combustion Chambers with LES, Advanced Fluid Dynamics, Prof. Hyoung Woo Oh (Ed.), ISBN: 978-953-51-0270-0, InTech, Available from: <http://www.intechopen.com/books/advanced-fluid-dynamics/stability-investigation-of-combustion-chambers-with-les>

# **INTECH**

open science | open minds

### **InTech Europe**

University Campus STeP Ri  
Slavka Krautzeka 83/A  
51000 Rijeka, Croatia  
Phone: +385 (51) 770 447  
Fax: +385 (51) 686 166  
[www.intechopen.com](http://www.intechopen.com)

### **InTech China**

Unit 405, Office Block, Hotel Equatorial Shanghai  
No.65, Yan An Road (West), Shanghai, 200040, China  
中国上海市延安西路65号上海国际贵都大饭店办公楼405单元  
Phone: +86-21-62489820  
Fax: +86-21-62489821