

On Modeling Depths of Power Electronic Circuits for Real-Time Simulation – A Comparative Analysis for Power Systems

Giovanni De Carne, *Senior Member, IEEE*, Georg Lauss, *Member, IEEE*, Mazheruddin H. Syed, *Member, IEEE*, Antonello Monti, *Senior Member, IEEE*, Andrea Benigni, *Senior Member, IEEE*, Shahab Karrari, *Student Member, IEEE*, Panos Kotsampopoulos, *Senior Member, IEEE* Md Omar Faruque, *Senior Member, IEEE*

Abstract—Investigations of the dynamic behaviour of power electronic components integrated into electric networks require suitable and established simulation methodologies. Real-time simulation represents a frequently applied methodology for analyzing the steady-state and transient behavior of electric power systems. This work introduces a guideline on how to model power electronics converters in digital real time simulators, taking into account the trade-off between model accuracy and the required computation time. Based on this concept, possible execution approaches with respect to the usage of central processing unit and field-programmable gate array components are highlighted. Simulation test scenario, such as primary frequency regulation and low voltage ride through, have been performed and accuracy indices are discussed for each implemented real-time model and each test scenario, respectively. Finally, a run-time analysis of presented real-time setups is given and real-time simulation results are compared. This manuscript demonstrates important differences in real-time simulation modelling, providing useful guidelines for the decision making of power engineers.

I. INTRODUCTION

Real-time simulation has become part of the everyday practice for power engineers in the last few years. The challenges created by the evolution of the power grid towards a renewable-based power system are making the interest for advanced testing more and more significant. At the same time, this transition means also that we are moving from a traditional electromechanical system to a power electronic-dominated grid. This transition is deeply affecting the traditional concepts of power systems dynamics and consequently have effects on the simulation approaches [1].

Giovanni De Carne and Shahab Karrari are with the Karlsruhe Institute of Technology (KIT), Karlsruhe, Germany. e-mail: giovanni.carne@kit.edu, shahab.karrari@kit.edu

G. Lauss is with the Austrian Institute of Technology (AIT), Vienna, Austria. e-mail: georg.lauss@ait.ac.at

M. Syed is with the Institute of Energy and Environment, University of Strathclyde, Glasgow, Scotland. e-mail: mazheruddin.syeds@strath.ac.uk

Antonello Monti is with RWTH Aachen University and Fraunhofer FIT, Aachen, Germany. e-mail: amonti@eonerc.rwth-aachen.de

Andrea Benigni is with FZ Jülich, RWTH Aachen University and JARA-Energy, Jülich, Germany. e-mail: a.benigni@fz-juelich.de

Panos Kotsampopoulos is with the National Technical University of Athens (NTUA), Athens, Greece. e-mail: kotsa@power.ece.ntua.gr

Md Omar Faruque is with FSU Florida State University Tallahassee, U.S. e-mail: mfaruque@eng.famu.fsu.edu

This work is a joint work of the IEEE PES TF "Task Force on Real-Time Simulation of Power and Energy Systems". The work of Giovanni De Carne was supported by the Helmholtz Association within the Helmholtz Young Investigator Group "Hybrid Networks" (VH-NG-1613), and under the joint initiative "Energy System Design" in the Research Field Energy.

While the simulation of power electronics is already per se a challenge [2], the real time condition brings further requirements, and thus requests dedicated modeling and simulation approaches. Good reviews of the state of the art for power system simulation in real time can be found in [3], [4] or [5], while specific solutions for real time simulation of power electronics are reported in [6], [7] and [8]. The purpose of this paper is to bring this knowledge together and present a structured approach to select the proper modeling approach and solver implementation to support the real time simulation of power electronics in a power system application.

The real-time constraint brings the need for a compromise in the modeling complexity, which has to be assessed a priori to get meaningful results. On the other hand, because real time simulation has been moving towards smaller and smaller time steps, it is also reasonable to consider integration methods normally not considered for the off-line case. The set of considerations makes clear that approaches to real-time simulation may differ significantly from the solution adopted for desktop simulations, and the type of trade-off to be considered are quite different. Last but not least, also the type of hardware platform can make a difference. Solutions based on FPGA, for example, are only adopted for real time simulation, opening new horizon for the modeling options [9].

In the paper, we propose categories of models and analyse the features of such categories with respect to realistic use case scenarios in power system. Furthermore, in the case of real time simulation, the specific execution approach plays also a key role. For this reason, a specific analysis is also presented to understand the main implication of central processing units (CPU) based approaches versus field programmable gate arrays (FPGA) implementations. As one major contribution of this work, the accuracy of implemented models is compared by means of relative two-norm error indices. In addition, run time analysis related to the required computational power for respective converter models is performed.

This article is structured in the subsequent manner: following this introduction I representing the state-of-the-art in research, section II presents real-time simulation scenarios with particular focus on functional parts of power electronic devices. In section III, real-time modelling approaches of respective devices are discussed. Section IV introduces important benefits and limitations related to the execution and implementation of different modelling approaches. Section V highlights several examples of simulation setups where

HVDC system and the power network are represented with equivalent transfer functions, modelling the system inertia and generator model. This modelling has been considered sufficient for depicting the active power exchange among the HVDC and the system, neglecting the impact of reactive power on the frequency control.

- **Fault Ride Through (FTR):** In [17] a simplified linearized model of the doubly-fed induction generator (DFIG) turbine is developed to verify a newly proposed fault ride through approach. However, for certain applications, a more detailed representation of the converter is needed. As an example, in [18], the fault ride through strategy for a Multilevel Modular Converter (MMC) has been proposed, working on the switching status of its semi-conductors. As a consequence, the full switching model of the MMC needs to be modelled. In [19], the fault ride through of generic voltage source converters has been proven by using a full switching model of the converter. Despite working more at higher control level, rather than at lower level PWM control, the authors wanted to have the highest accuracy possible, to be compared then with experiments.

C. Metrics

The two main aspects will be considered in evaluating the modeling approaches considered in this paper: execution time and accuracy. Regarding the execution time, a normalized value of execution time will be utilized as a metric, obtained using the execution time of a single converter modelled at the highest level of detail as base. To evaluate the accuracy, instead, we will compare the difference of the simulation results of each model with respect to ones from higher complexity models, as described in next Section III.

The accuracy of the presented models is compared by means of relative two-norm error index as below:

$$E^J = \frac{\|x_i^J - x_i^{J+K}\|_2}{\|x_i^{J+K}\|_2} = \frac{\sqrt{\sum_{i=1}^{N_s} (x_i^J - x_i^{J+K})^2}}{\sqrt{\sum_{i=1}^{N_s} (x_i^{J+K})^2}} \quad (1)$$

where x_i is a generic electrical variable (for example active power) at time i , N_s is the total number of time steps, J represents the chosen model between the ones shown in Fig. 3, and $J + K$ represents the model with K -step higher accuracy than model J . As an example, Model (e) is $K = 2$ higher accuracy steps than Model (c).

This metric allows to understand if a further accuracy step is required for a specific power system study, or the chosen one gives already accurate results. If the two-norm error E^J between two models is smaller than a certain threshold (e.g. 1%), the J -level model can be chosen, while the $J + K$ -level model may only increase the computational time without increasing the simulation accuracy.

III. MODELING APPROACHES

In general, many different approaches may be categorized, applied, and implemented for real-time based modeling as is

TABLE I
REAL-TIME MODELS AND IMPLEMENTED CONTROLS

Model	Current Control	PLL	Power control	DC voltage control	Switching elements
(a)	✓	✗	✗	✗	✗
(b)	✓	✓	✗	✗	✗
(c)	✓	✓	✓	✗	✗
(d)	✓	✓	✓	✓	✗
(e)	✓	✓	✓	✓	✓

well documented in literature [4], [5]. In this work, particular focus is set on the real-time modeling and implementation of power electronic devices for grid-connected applications. In contrast to work presented in [2], where power electronics modeling for non-real-time (or offline) simulators has been discussed, this work analyzes the implications of modeling under the constraints set by real time simulators.

As highlighted in Fig. 1, a converter device consists out of different subsystems and it is the aim of this work to point out the cascaded modeling process for each of these parts. Depending on the need of the modeling depth, several subsystems may be simplified or even neglected. For transient scenarios, correct results can only be achieved when corresponding control subsystems with fast dynamics are included in the model and implemented accordingly.

Tab. I presents a summary of real-time models relevant for subsequent case studies. Their implementations include the integration of different control systems, primarily applied for smart grid applications. Starting from the simplest to the most complete one, these models have been categorized with crescent letter denomination, as listed in Tab. I and shown in Fig. 3.

- **Model (e)** consists of a complete representation of the power converter, including the switching elements and passive elements, such as the grid filter and DC link capacitors. The controller layers have been represented in details: the front-end converter is controlled in current. It receives its reference from an outer DC voltage control loop, and provide the modulation signal in output, that the PWM algorithm transforms in the gate signals for the semiconductor switches. The power flow is regulated by the energy source converter (e.g., a buck-boost or Dual Active Bridge converter that control the power flow in an energy storage system), here modeled as a power-controlled current source. An additional modeling layer can be added, including the thermal behaviour of the switching elements. This aspect can be critical for reliability studies [20], and it is strictly related to the converter power profile [21]. Further, model details of the energy source can be added at this stage. However, in order not to lose in generality in this work, the modelling of a particular energy source (e.g., photovoltaic, battery bank) has been omitted, and left for the specific modelling case.
- **Model (d)** differs from the Model (e) in the modelling of the power hardware. Instead of the semiconductor switches models, Model (d) adopts an average modelling approach, that averages the voltage across the semicon-

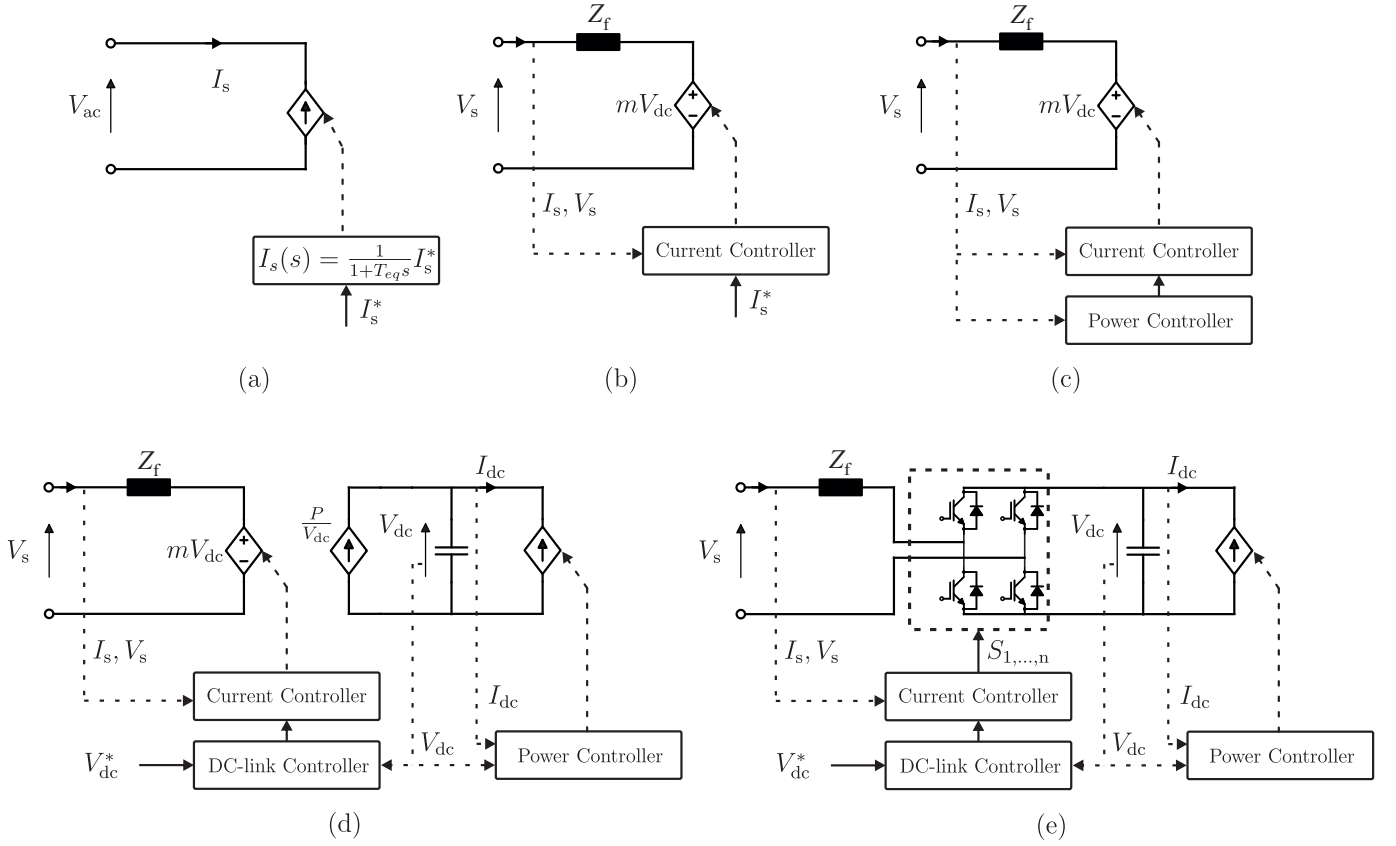

Fig. 3. Detailed description of several real-time models for power electronic devices: average model with simplified current control (a); rms models with implemented PLL, current control (b), power control (c), DC link control (d) and with an energy source model connected (e); switching model with all control systems implemented (f)

ductors within one switching period T_s :

$$\bar{v}(t) = \frac{1}{T_s} \int_{\tau-T_s/2}^{\tau+T_s/2} S_{1,\dots,n}(\tau) V_{dc} d\tau \quad (2)$$

where T_s is the switching frequency of the converter, $S_{1,\dots,n}$ are the $S_i = \{0, 1\}$ switching signals of each semiconductor, and V_{dc} is the DC-link voltage. As a result, the control loops within model (d) remain unchanged. The PWM block is omitted and the modulation signal is amplified by the measured DC voltage V_{dc} and sent to a controlled voltage source, that represents the average voltage output from the power switches.

- **Model (c)** neglects the dynamics of the converter DC link, incorporating the power controller in the front-end converter. This model starts with the assumption that the DC link capacitor bank is sufficiently big, or the phenomenon under observation is sufficiently small, to allow a decoupling between the AC and DC side of the converter.
- **Model (b)** simplifies the control loop, considering only the current controller of the converter. This simplification is assumed valid in the case where the phenomenon under observation is faster than the dynamics of the power controller, and therefore can be assumed static for the considered time window. The model includes a PLL allowing for the calculation and injection of current

reference I_s^* from a power set-point and the PCC voltage measurement V_s .

- **Model (a)** is an open-loop, equivalent current controller that injects the current reference I_s^* with a certain dynamic determined by the time constant T_{eq} . This model does not include a PLL, thus can be used only within simulation software that provide a global angle.

IV. EXECUTION APPROACHES

In actual state-of-the-art real-time simulators two type of functional devices are mainly used as computational units: CPUs and FPGAs. The purpose of this section is to provide an overview of current use of CPU and FPGA technologies for real-time simulation of power electronics systems.

In general, we can say that CPU based solutions offer higher flexibility and higher throughput due to the much higher clock frequency involved. At the same time, FPGA based solutions are becoming more and more relevant for highly dynamic investigations of real-time simulation of power electronics based systems. The growth in the use of FPGAs for the simulation of power electronics converters is due to mainly two reasons. Historically, FPGAs have been used in real-time simulation applications for the same reasons they were and are used in power electronics control solutions: input-outputs management and signal conditioning. For example, all major commercial real time simulators can sample gate signals at a

frequency higher than the one of the simulation time step so to reduce the effect of inter time step switching events.

In this context, FPGA have been used also for pre-processing of the sampled data [22]. More recently FPGA started being used also for computational purposes, directly solving part or the whole system model. The FPGAs structure provides an unique chance to maximize parallel execution also of very small computational tasks introducing minimal overhead and the very low latency ensures real time operation also with very small time steps of less than $1 \mu\text{s}$. As demonstrated in [9] and [23], FPGA can be used to achieve almost perfect parallelizability of the solution flow so that the time step used for the simulation became independent from the size of the system. In this way very detailed models of power electronics converters, also including switching device modelling [24] - [25], can be executed for real-time system level studies. FPGA can also be used to accelerate CPU based simulation of complex converters (e.g. MMC) when very small time step execution is not required, as for example in [26]. Furthermore, FPGA based solvers, as demonstrated in [27], make also possible to solve those complex power electronics converter using very small time step such as 50 ns.

The major issue in the use of FPGA for real time simulation is the time-consuming and error-prone model development process. Compared to what is actually possible with CPU, the process is difficult to automate and it requires a significant involvement of the final user. To overcome these limits without sacrificing flexibility such as using pre-developed model scenarios, the use of High Level Synthesis (HLS) languages have become more popular in recent years. For a comprehensive review of recent development in FPGA based simulation of power electronics systems, also looking at device level modelling and at development tools (e.g. HLS), please refer to [8]. Another limit of FPGA solution is given by the limited resources availability on the single FPGA. To overcome this limit multi-FPGA solutions have been developed for the purpose of simulating very large systems [28].

V. SIMULATION EXAMPLES

The following section lays the foundations for the run-time comparison of selected, real-time based models. Each of the simulation setups is described in detail and a comparison of achievable run-times is performed. In addition, resulting alterations of the control behaviour of respective models are analysed for different grid scenarios.

In what follows, two selected, representative test scenarios are discussed and results are compared for the purpose of validated comparison. Firstly, the primary frequency regulation capability is demonstrated for all models. Secondly, the dynamic behaviour for a symmetrical three-phase FRT scenario is discussed for respective models.

A. Primary Frequency Regulation

As an initial condition, each of the models is connected to an ideal, three-phase grid modeled by three single-phase voltage sources with a nominal line-to-line AC voltage value of $U_{LL} = 400 \text{ V}$ at a nominal frequency of $f_{\text{nom}} = 50 \text{ Hz}$.

Different models are all executed in real-time and results with respect to the primary frequency regulation are compared one to each other. The first three models are all average models with different implementations of control circuits, while the fourth model is given by a simplified transfer function model.

As a test scenario representing a fundamental functionality for grid-connected, active generation units, the primary frequency regulation is discussed. Figure 4 shows plots of the line frequency and the active power of above-mentioned real-time models, respectively. Results show that each of the real-time models is capable of achieving the required dynamic behavior for a correct primary frequency regulation. A comparison of graphs shows that there is only marginal difference between applied models (i.e.: "model (d)", "model (c)", "model (b)", and "model (a)"). Even if not being shown in Fig. 4, it may be noted that plots of all other models show similar behaviour and accurate results. Therefore, a simplification of the model can be applied without losing in representation fidelity.

For this basic test scenario, the power and frequency behavior of respective real-time models is almost identical. This outcome could be expected, and this simple case study has been chosen on purpose in order to demonstrate the validated dynamic behaviour for all models. Tab. II shows accuracy indices for each model as resulting figures for the primary frequency regulation test case.

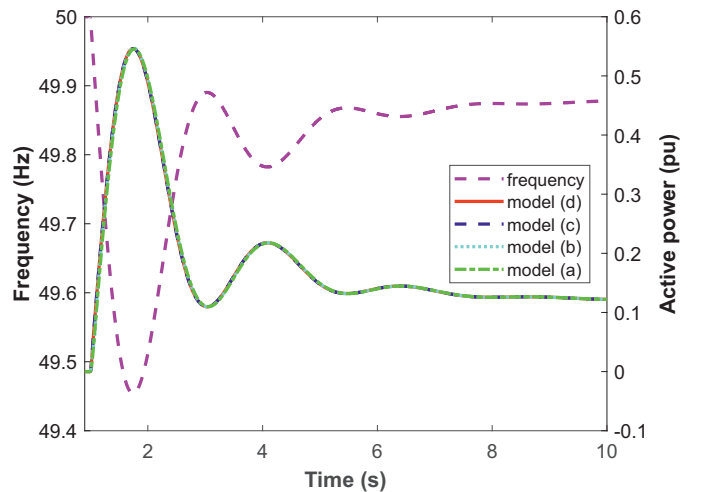

Fig. 4. Test Scenario: primary frequency regulation; plot of the system frequency (left y-axis, marked in magenta) and active power (right y-axis) for selected real-time models (marked with different colors as shown in the legend).

TABLE II
 E^J %. ACCURACY INDICES FOR EACH MODEL FOR PRIMARY FREQUENCY REGULATION TEST CASE

Model	(a)	(b)	(c)
(b)	1.09	-	-
(c)	2.37	1.47	-
(d)	2.28	1.37	0.10

B. Fault Ride Through (FRT)

Compared with the primary frequency control, the FRT scenario shows much higher dynamics which represents the challenge for each of the models when tracking transients. Based on these properties, differences related to the dynamic behaviour and the overall performance is expected for test scenarios such as the FRT test. For this test scenario, the missing of controls of subsystems will have an impact on the dynamic behaviour and it is expected that results reflect the modelling depth of selected models. Two test scenarios are considered: Firstly, a symmetrical voltage dip from 1.0 p.u. to 0.7 p.u. with a fault duration of 100 ms is tested. Secondly, a voltage dip from 1.0 p.u. to 0.3 p.u. with a fault duration of 100 ms is discussed.

For each of the FRT tests, three models have been selected and results are discussed for models: "model (e)", "model (d)", and "model (c)". Since model (e) includes not only all control circuits but also switching components, it is assumed that this model will show optimum performance for high transients. For average models (d) and (c), different tracking behavior during transients are expected for the real-time models. For all figures, graphs are marked with the following colors: "model (e)" is marked by the black color, "model (d)" by the red color, and "model (c)" is marked by the blue color.

During FRT events, control circuits of active devices are tested for the correct functioning and accurate behavior. Alongside the accurate control of positive sequence voltages and currents, the corresponding active, reactive, and apparent power values has to be validated. Under these transient conditions, instability may occur when control circuits are ill conditioned or improperly configured. Furthermore, the signal accuracy represents an important criterion to assess the real-time performance of the related models. The latter is related to the modeling depth and the quality of the executed model. Stability and accuracy of real-time models are discussed for different FRT scenarios.

1) *FRT Test Case 1 (symmetrical 3-phase LVRT; $U = 0.7$ p.u.):* For the first FRT test case, initial conditions are defined as follows: each model is connected to an ideal, three-phase grid modeled by three single-phase voltage sources with a nominal line-to-line AC voltage value of $U_{LL} = 400$ V at a nominal frequency of $f_{nom} = 50$ Hz. Before, during, and after the fault, the active power setpoint is set to 0.5 p.u., while the reactive power setpoint is set to 0 p.u.

As can be noted in Fig. 5, as soon as the voltage dip is applied, the active power injection surges, due to an initially uncontrolled current in-rush. As consequence, the power controller-loop in all three models tries to restore the power output to the initial conditions. However, this occurs with different dynamics, depending on the models. While the model (e) and model (d) do not differ in the power dynamic, model (c) shows a more damped behaviour, reducing the second power swing during the transients. This can be noted also during the voltage restoration at 0.4 s.

Similar results can be found in the reactive power plot in Fig. 6, where model (c) shows an overdamped dynamic with respect to the reactive power profiles in model (e) and model

(d). The reason of such behaviour can be found in the DC link modelling difference. Whereas in model (e) the DC link is fully modeled, and in model (d) its dynamics are represented with an average model, in model (c) it is neglected. As a consequence, the DC voltage dynamic, shown in Fig. 7, and its related controller are not considered.

A comparison of results in Figs. 5, 6, and 7 shows that the dynamic behaviour of models (d) and (e) is not significantly different when considering respective time constants at the start and at the end of the voltage dip. Since model (e) is a true switching model, the DC link voltage and also the reactive power show higher noise. However, the signal average of model (e) shows identical amplitudes compared with model (d) except for transient in-rush scenarios. When analysing results of model (c) it must be noted that time constants of transient scenarios are higher and the dynamic behaviour differs for models (d) and (e). In the same manner, signal amplitudes of model (c) for transient scenarios are not accurate and show lower values, in general. For steady state behaviour, all models (c), (d), and (e) show accurate results and reproduce correct DC voltage signals as well as active and reactive power signals. Results show that stability for the FRT test case 1 with configured grid voltage dip settings could be achieved for respective models. Tab. III presents resulting accuracy indices for each model for FRT Test Case 1.

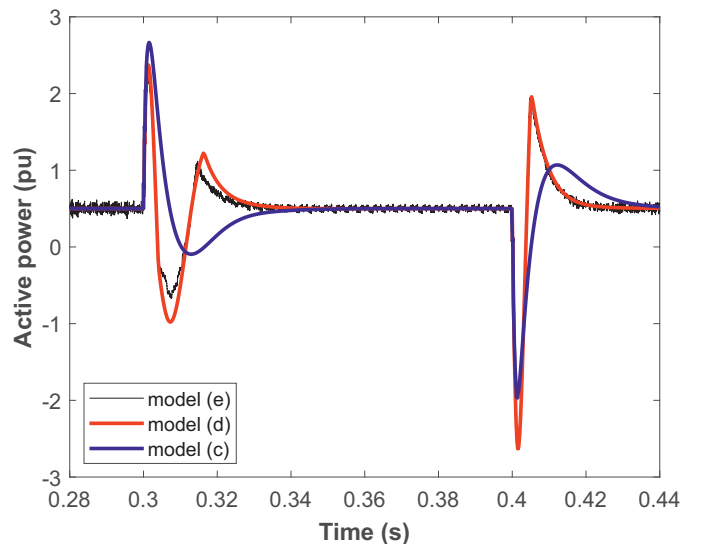

Fig. 5. Test Scenario: FRT Test Case 1; plot of active power for selected real-time models.

TABLE III
 E^J %. ACCURACY INDICES FOR EACH MODEL FOR FRT TEST CASE 1

Model	(b)	(c)	(d)
(c)	702.9	-	-
(d)	709.7	78.0	-
(e)	707.4	66.3	18.3

2) *FRT Test Case 2 (symmetrical 3-phase LVRT; $U = 0.3$ p.u.):* The limitations in neglecting the DC link dynamics are more evident in this second case. For the second FRT test case, identical initial conditions are given as for the FRT test

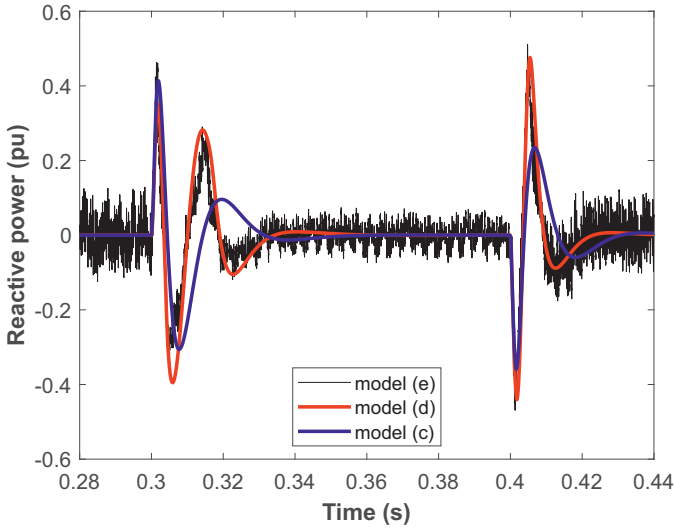

Fig. 6. Test Scenario: FRT Test Case 1; plot of reactive power for selected real-time models.

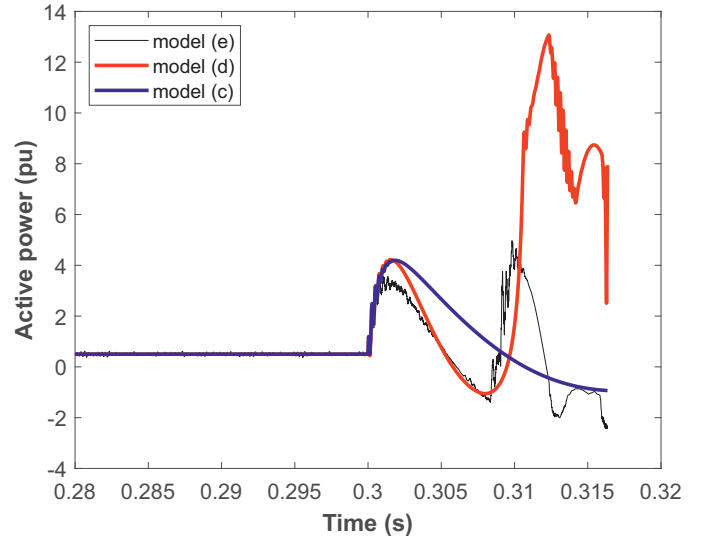

Fig. 8. Test Scenario: FRT Test Case 2; plot of active power for selected real-time models.

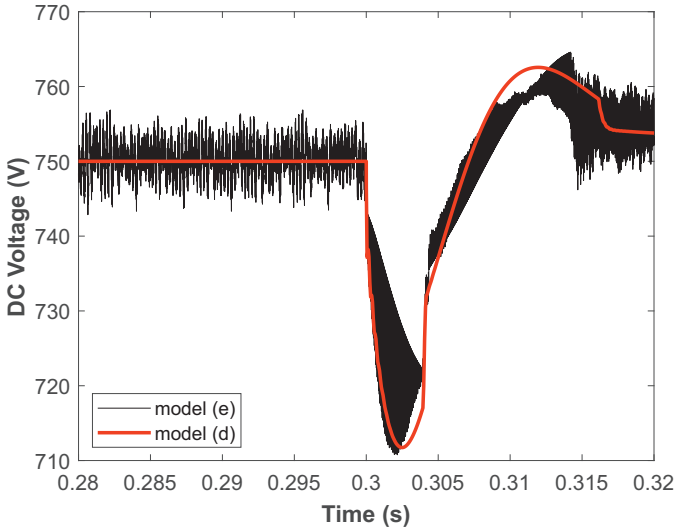

Fig. 7. Test Scenario: FRT Test Case 1; plot of DC link voltage at fault entry for selected real-time models.

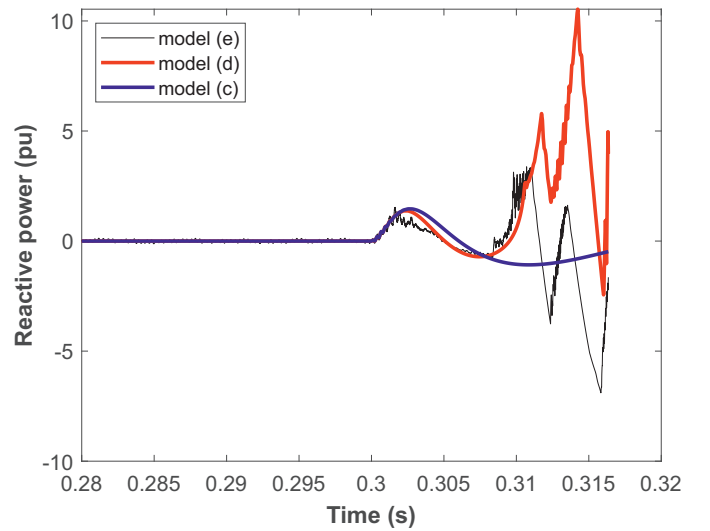

Fig. 9. Test Scenario: FRT Test Case 2; plot of reactive power for selected real-time models.

case 1. As unique difference to test case 1, the applied voltage drop is increased from 0.3 p.u. to 0.7 p.u. with respect to the nominal voltage.

In contrast to the FRT test case 1, where only damping differences have been noted, in test case 2 the stability of the converter has been compromised. As can be noted in Figs. 8 and 9 for the active and reactive power, respectively, model (e) and model (d) destabilize after a short transient, on the opposite of model (c), that tries to restore the initial conditions. The reason can be found in the DC link modelling. Neglecting the DC link model, model (c) does not see the impact of the low DC link voltage conditions of model (d) and model (e) as shown in Fig. 10. Due to the voltage drop severity, the converter transfers a sufficient amount of energy to deplete the DC link capacitors, and thus their voltage drops below the AC voltage peak. As a consequence, the converter goes out from the linear control region, destabilizing after few milliseconds.

It can be concluded that stability could not be achieved for all models for the FRT test case 2. When comparing results to FRT test case 1, modified stability properties are caused the higher value of the applied voltage dip, which results in an uncontrollable state of the control of respective models.

VI. COMPUTATIONAL TIME ANALYSIS

In this section, the required computational time for simulating each model in real time has been calculated following the benchmark described in Section II, and depicted in Fig. 2.

To assess the execution time of each model, the converter is connected directly to a voltage source, and then it is compiled and executed on an OP4510 real-time simulator using the software RT-LAB. The monitoring tool of RT-LAB allows selecting 100 consecutive simulation time steps during the simulation, and calculate the average, minimum and maximum model execution time within these 100 time steps. This tool

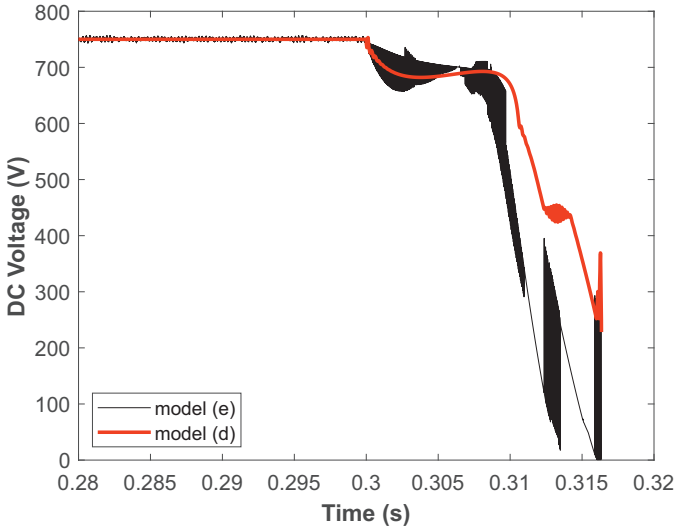

Fig. 10. Test Scenario: FRT Test Case 2; plot of DC link voltage for selected real-time models.

allows users to assess their model computation requirements in order to avoid over-runs for real-time simulations. Although this approach cannot provide an exact computational effort calculation and depends on the used hardware, it can provide a good estimation of the relative required execution time for each model, which is the scope of this work. Without losing in generality, the results of this section can be transferred to other simulation platforms. Despite some changes in the absolute results, the required computational time trend should not suffer from substantial deviations.

In this case, the parallel connection through a 0.1Ω resistance of up to 15 converters has been considered. In Fig.11, the results of this analysis are normalized with respect to the required computational power of a single model (e) converter, that is $2.61 \mu\text{s}$. The reason for this normalization lies on the fact that we are not interested in the absolute values, but rather on the relative values and the trend of increased simulation time for additional parallel connected converters. From the results in Fig.11, the following conclusions can be drawn:

- The complexity of the controller has little to no impact on the required simulation time. Model (b), (c), and (d) computational times do not change noticeably when varying the number of parallel converters.
- The use of open-loop, current source-based models can be greatly beneficial to large scale simulations, such as frequency regulation studies. A 3-times computational speed factor lies between the other average models and model (a), making the latter more suitable for such studies.
- The computational time does not increase linearly with the number of converters, but it shows a parabolic growth, which acceleration factor varies between current-sources and voltage-sources based modelling approaches.
- Model (e) computational time grows non-linearly after only few parallel converters are considered.

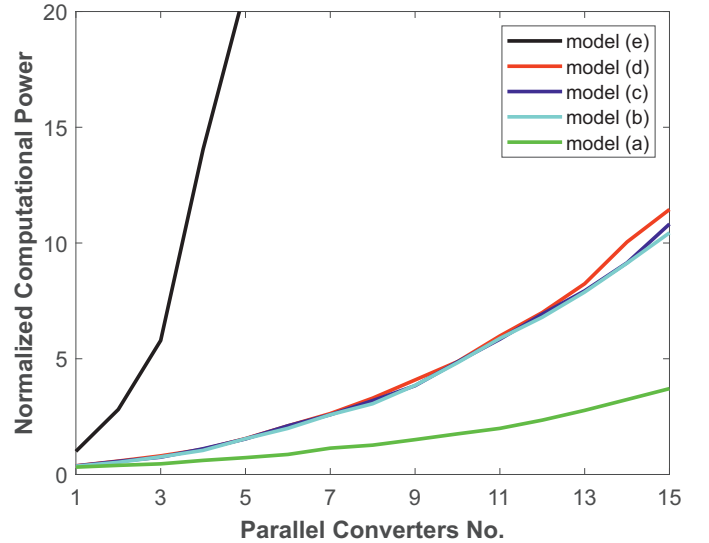

Fig. 11. The required computational power. The y-axis is normalized with respect to the required computational power of a single converter of model (e)

VII. MODELLING RECOMMENDATION FOR REAL TIME SIMULATIONS

This section concludes the modelling work, proposing guidelines for engineers on the modelling of power converters for digital real time simulation applications.

A. Recommendation for model's choice

Two aspects have been addressed, related to CPU-based and FPGA-based simulations. The following recommendation can be made for CPU-based simulations:

- Model (e) can be represented in CPU-based solver only if the ratio between switching frequency and real time simulation time-step is higher than 10. This is a safety rule to be able to represent carefully the dynamic spectrum of the converter (i.e., switching frequency). Considering the relatively high required computational time ($2.61 \mu\text{s}$), only few converters are recommended to be simulated in CPU-based simulations. If higher switching frequencies are presents, FPGA solutions shall be considered.
- Considering the low impact on the simulation time-step, model (d) shall be preferred over model (c) and (b). It increases the model accuracy, while no impact on the required computational power has been noted.
- If large scale simulation shall be performed, model (a) represents a viable option, considering the low requirements for computational power. Model (a) shall be recommended only if the analyzed system dynamics are several magnitude order slower than the internal current control of the converter (e.g., for primary frequency studies).

In general for system level studies, CPU based solutions are still the recommended choice. FPGA solutions are recommended when:

- the analysis objective require a model of model (e) type and a switching frequency above 20 kHz is used, e.g. [29].

TABLE IV
REAL-TIME MODELS AND GRID SCENARIOS: SUITABLE (✓), NOT SUITABLE (✗), NOT NEEDED (○)

Model	Frequency Regulation	Reactive Power Provision	Grid forming	Islanding	Fault Ride Through	Faults
A	✓	✗	✗	✗	✗	✗
B	✓	✓	✗	✗	✗	✗
C	✓	✓	✓	✓	✗	✗
D	○	○	✓	✓	✓	✗
E	○	○	○	○	✓	✓

- independently on the model used for the power electronics converter the dynamic of interest are governed by very small parasitic values. For example, in [30] a platform for testing of DC protection has been developed, in this case the very small time step used was required by the short cable considered and not by the switching frequency.

To conclude, another application for which FPGA based solver appears as a suitable solution is the real-time analysis of common mode effect. This has not been yet verified.

B. Application guidelines for power system studies

As a conclusion of this work, Table IV proposes an application guideline for choosing a proper model for specific power system studies, where it is possible to appreciate the different trade-off in terms of complexity and computational effort. In Table IV, the power system studies are allocated from the slowest (on the left) to the fastest dynamics (on the right). As can be noted, the power system dynamic affects the model choice:

- Frequency Regulation:** dynamics in the range of few Hertz are involved, leaving only the slowest control loops (e.g., power loop) in the front-end converter that can influence the system dynamics. Considering also the system size for these studies, models from (a) to (c) are recommended.
- Reactive Power Provision:** the reactive power provision can reach up to several hundreds of Hertz dynamics. Model (a) can be excluded from these studies, as well as Model (d), due to the low influence of the DC-link in the service provision (assuming a stable regulation of DC voltage). Models (b) and (c) are recommended for these studies, considering that the power and current loops are directly involved in the provision of reactive power.
- Grid forming:** for grid forming converters (e.g., wind turbines converter, Smart Transformer) the outer loops, such as the voltage/power control, play a fundamental role. For this reason, Model (b) shall be excluded from this analysis, and only Model (c) and (d) are recommended.
- Islanding:** in islanding detection strategies, controlled active and reactive power disturbance are inserted in the system, to verify the islanded condition. It follows that the power loop (Model (c)) and DC-link voltage loop (Model (d)) are fundamental to achieve accuracy islanding detection algorithm results.
- Fault Ride Through:** as demonstrated in this work, the results accuracy for fault ride through studies depends on the DC-link status. If low AC voltages are reached,

the DC link voltage may drop leading to an unstable converter condition. As a conclusion, while Model (d) provides good accuracy in the results, Model (c) cannot represent fully the study behaviour. Model (e) can be applied in this case for a full representation of the study, however, it comes to a higher computational time cost.

- Faults:** a converter fault current contribution depends on the energy stored in the passive elements (both AC and DC) and on the switching elements blocking capability. For these reasons, average models (from (a) to (d)) are not suitable for these studies, and only a full-switching model (e) can fully represent the fault current behaviour.

VIII. CONCLUSIONS

This paper presented a rather comprehensive set of guidelines for developing real time simulation of power system scenarios with high penetration of power electronics. Starting from the definition of 5 categories of models, a quantitative analysis is performed with reference to two meaningful system level studies. The quantitative evaluations allow the user to understand the modeling compromises in moving from one level of details to another. The accuracy analysis reported in Table II and III has been then enriched by a computing time analysis in Figure 11 which help the users understanding the possible challenges that may emerge in the model selection with reference to scalability. Finally, a modelling guideline has been proposed, where in Table IV the recommendation for a proper model choice depending on the power system study is provided.

APPENDIX

The modeled converter data have been listed in Table V, in order to allow reproducibility of the results. The filter Z_f in Fig.3 is a *LCL* filter. The converter current and DC voltage controllers are *PI* controllers and they have been tuned following the indication in [31] on cascaded DC and AC controller for power converters.

ACKNOWLEDGMENT

This work is supported by the IEEE TF "Task Force on Real-Time Simulation of Power and Energy Systems".

REFERENCES

- [1] M. Paolone, T. Gaunt, X. Guillaud, M. Liserre, S. Meliopoulos, A. Monti, T. Van Cutsem, V. Vittal, and C. Vournas, "Fundamentals of power systems modelling in the presence of converter-interfaced generation," *Electric Power Systems Research*, vol. 189, p. 106811, 2020. [Online]. Available: <https://www.sciencedirect.com/science/article/pii/S037877962030482X>

TABLE V
POWER CONVERTER DATA

Parameter	Value	Parameter	Value
Nominal Power P_n	10 kW	DC voltage V_{dc}	750 V
Nominal Voltage V_n	230 V	Current Controller P	2.5 p.u.
Converter side L_c	0.85 mH	Current Controller I	150 p.u.
Converter side R_c	0.1 Ω	Power Controller P	5 p.u.
Grid side L_g	0.5 mH	Power Controller I	200 p.u.
Grid side R_g	0.1 Ω	DC Controller P	0.7 p.u.
Filter Capacitance C_f	5.5 μ F	DC Controller I	135 p.u.
Filter Damping R_f	2 Ω	Time Constant T_{eq}	20 ms
DC Capacitor C_c	5 mF		

- [2] G. De Carne, M. Langwasser, M. Ndreko, R. Bachmann, R. W. De Doncker, R. Dimitrovski, B. J. Mortimer, A. Neufeld, F. Rojas, and M. Liserre, "Which deepness class is suited for modeling power electronics?: A guide for choosing the right model for grid-integration studies," *IEEE Industrial Electronics Magazine*, vol. 13, no. 2, pp. 41–55, 2019.
- [3] J. Bélanger, P. Venne, and J.-N. Paquin, "The what, where and why of real-time simulation," *Planet Rt*, vol. 1, no. 1, pp. 25–29, 2010.
- [4] M. O. Faruque, T. Strasser, G. Lauss, V. Jalili-Marandi *et al.*, "Real-time simulation technologies for power systems design, testing, and analysis," *IEEE Power and Energy Technology Systems Journal*, vol. 2, no. 2, pp. 63–73, 2015.
- [5] G. F. Lauss, M. O. Faruque, K. Schoder, C. Dufour, A. Viehweider, and J. Langston, "Characteristics and design of power hardware-in-the-loop simulations for electrical power systems," *IEEE Transactions on Industrial Electronics*, vol. 63, no. 1, pp. 406–417, 2015.
- [6] L.-A. Grégoire, H. F. Blanchette, J. Bélanger, and K. Al-Haddad, "Real-time simulation-based multisolver decoupling technique for complex power-electronics circuits," *IEEE Transactions on Power Delivery*, vol. 31, no. 5, pp. 2313–2321, 2016.
- [7] A. Benigni and A. Monti, "A parallel approach to real-time simulation of power electronics systems," *IEEE Transactions on Power Electronics*, vol. 30, no. 9, pp. 5192–5206, 2014.
- [8] A. Benigni, T. Strasser, G. De Carne, M. Liserre, M. Cupelli, and A. Monti, "Real-time simulation-based testing of modern energy systems: A review and discussion," *IEEE Industrial Electronics Magazine*, vol. 14, no. 2, pp. 28–39, 2020.
- [9] M. Milton, A. Benigni, and J. Bakos, "System-level, fpga-based, real-time simulation of ship power systems," *IEEE Transactions on Energy Conversion*, vol. 32, no. 2, pp. 737–747, 2017.
- [10] X. Li, Y. Huang, J. Huang, S. Tan, M. Wang, T. Xu, and X. Cheng, "Modeling and control strategy of battery energy storage system for primary frequency regulation," in *2014 International Conference on Power System Technology*, 2014, pp. 543–549.
- [11] J. Dai, Y. Tang, Q. Wang, and P. Jiang, "Aggregation frequency response modeling for wind power plants with primary frequency regulation service," *IEEE Access*, vol. 7, pp. 108 561–108 570, 2019.
- [12] H. Ye, W. Pei, and Z. Qi, "Analytical modeling of inertial and droop responses from a wind farm for short-term frequency regulation in power systems," *IEEE Transactions on Power Systems*, vol. 31, no. 5, pp. 3414–3423, 2016.
- [13] Y.-J. Kim, L. K. Norford, and J. L. Kirtley, "Modeling and analysis of a variable speed heat pump for frequency regulation through direct load control," *IEEE Transactions on Power Systems*, vol. 30, no. 1, pp. 397–408, 2015.
- [14] H. Hui, Y. Ding, and M. Zheng, "Equivalent modeling of inverter air conditioners for providing frequency regulation service," *IEEE Transactions on Industrial Electronics*, vol. 66, no. 2, pp. 1413–1423, 2019.
- [15] Q. Zhai, K. Meng, Z. Y. Dong, and J. Ma, "Modeling and analysis of lithium battery operations in spot and frequency regulation service markets in australia electricity market," *IEEE Transactions on Industrial Informatics*, vol. 13, no. 5, pp. 2576–2586, 2017.
- [16] M. Langwasser, G. De Carne, M. Liserre, and M. Biskoping, "Primary frequency regulation using hvdc terminals controlling voltage dependent loads," *IEEE Transactions on Power Delivery*, vol. 36, no. 2, pp. 710–720, 2021.
- [17] P.-H. Huang, M. S. El Moursi, and S. A. Hasen, "Novel fault ride-through scheme and control strategy for doubly fed induction generator-based wind turbine," *IEEE Transactions on Energy Conversion*, vol. 30, no. 2, pp. 635–645, 2015.
- [18] D. Zhou, P. Tu, H. Qiu, and Y. Tang, "Finite-control-set model predictive control of modular multilevel converters with cascaded open-circuit fault ride-through," *IEEE Journal of Emerging and Selected Topics in Power Electronics*, vol. 8, no. 3, pp. 2943–2953, 2020.
- [19] P. Piya, M. Ebrahimi, M. Karimi-Ghartemani, and S. A. Khajehoddin, "Fault ride-through capability of voltage-controlled inverters," *IEEE Transactions on Industrial Electronics*, vol. 65, no. 10, pp. 7933–7943, 2018.
- [20] H. Wang, M. Liserre, and F. Blaabjerg, "Toward reliable power electronics: Challenges, design tools, and opportunities," *IEEE Industrial Electronics Magazine*, vol. 7, no. 2, pp. 17–26, 2013.
- [21] M. Andresen, G. De Carne, and M. Liserre, "Load-dependent active thermal control of grid-forming converters," *IEEE Transactions on Industry Applications*, vol. 56, no. 2, pp. 2078–2086, 2020.
- [22] H. Figueroa, A. Monti, and X. Wu, "An interface for switching signals and a new real-time testing platform for accurate hardware-in-the-loop simulation," in *2004 IEEE International Symposium on Industrial Electronics*, vol. 2, 2004, pp. 883–887, 2004.
- [23] M. Milton and A. Benigni, "Latency insertion method based real-time simulation of power electronic systems," *IEEE Transactions on Power Electronics*, vol. 33, no. 8, pp. 7166–7177, 2018.
- [24] Z. Huang and V. Dinavahi, "A fast and stable method for modeling generalized nonlinearities in power electronic circuit simulation and its real-time implementation," *IEEE Transactions on Power Electronics*, vol. 34, no. 4, pp. 3124–3138, 2019.
- [25] H. Bai, H. Luo, C. Liu, D. Paire, and F. Gao, "A device-level transient modeling approach for the fpga-based real-time simulation of power converters," *IEEE Transactions on Power Electronics*, vol. 35, no. 2, pp. 1282–1292, 2020.
- [26] H. Saad, T. Ould-Bachir, J. Mahseredjian, C. Dufour, S. Denetière, and S. Nguéfeu, "Real-time simulation of mmcs using cpu and fpga," *IEEE Transactions on Power Electronics*, vol. 30, no. 1, pp. 259–267, 2015.
- [27] M. Difronzo, M. M. Biswas, M. Milton, H. L. Ginn, and A. Benigni, "System level real-time simulation and hardware-in-the-loop testing of mmcs," *Energies*, vol. 14, no. 11, 2021. [Online]. Available: <https://www.mdpi.com/1996-1073/14/11/3046>
- [28] M. Milton, A. Benigni, and A. Monti, "Real-time multi-fpga simulation of energy conversion systems," *IEEE Transactions on Energy Conversion*, vol. 34, no. 4, pp. 2198–2208, 2019.
- [29] J. Xu, K. Wang, P. Wu, Z. Li, Y. Liu, G. Li, and W. Zheng, "Fpga-based sub-microsecond-level real-time simulation of solid-state transformer with a switching frequency of 50khz," *IEEE Journal of Emerging and Selected Topics in Power Electronics*, pp. 1–1, 2020.
- [30] M. Vygoder, M. Milton, J. D. Gudex, R. M. Cuzner, and A. Benigni, "A hardware-in-the-loop platform for dc protection," *IEEE Journal of Emerging and Selected Topics in Power Electronics*, vol. 9, no. 3, pp. 2605–2619, 2021.
- [31] P. R. R. Teodorescu, M. Liserre, *Grid Converters for Photovoltaic and Wind Power Systems*. John Wiley & Sons, 2011.



Giovanni De Carne (S'14-M'17-SM'21) received the B.Sc. and M.Sc. degrees in electrical engineering from the Polytechnic University of Bari, Italy, in 2011 and 2013, respectively, and the Ph.D. degree from the Chair of Power Electronics, Kiel University, Germany, in 2018. He was post-doctoral fellow at Kiel University working on HVdc control and services until 2019. He is currently the head of the "Real Time System Integration" Group and head of the "Power Hardware In the Loop Lab" at the Institute for Technical Physics at the Karlsruhe

Institute of Technology. In 2020, Dr.-Ing. De Carne has been awarded with the Helmholtz "Young Investigator Group" for the project "Hybrid Networks: a multi-modal design for the future energy system". He has authored/coauthored more than 60 peer-reviewed scientific papers. His research interests include power electronics transformers, real time modelling, and power hardware in the loop. He is the Chairman of the IEEE PES Task Force on "Solid State Transformer integration in distribution grids". He is an Associate Editor of the IEEE Industrial Electronics Magazine and IEEE Open Journal of Power Electronics.



Georg Lauss received the Dipl.-Ing. degree from the Johannes Kepler University JKU Linz, Austria, in 2006 and jointly from the Eidgenössischen Technischen Hochschule ETHZ, Zürich, Switzerland, and the Université Pierre-et-Marie-Curie, Paris, France. He is a researcher with the AIT Austrian Institute of Technology, Vienna, Austria. His main interests include electromagnetic systems, power electronics, system and control theory, mathematical methods for optimized control systems, hardware-in-the-loop simulation systems, and real-time simulation for

electromagnetic power systems. Georg Lauss is the Chairman of the IEEE WG P2004 Recommended Practice for Hardware-in-the-Loop (HIL) Simulation Based Testing of Electric Power Apparatus and Controls and the IEEE PES Task Force on Real-Time Simulation of Power and Energy Systems.



Mazheruddin Syed (S'11-M'18) received his BE degree in Electrical and Electronics Engineering from Osmania University, India, in 2011, MSc degree in Electrical Power Engineering from Masdar Institute of Science and Technology, UAE, in 2013 and PhD degree in Electronic and Electrical Engineering from University of Strathclyde, Scotland in 2018. He is currently a Strathclyde Chancellor's Fellow (Lecturer) with the Institute for Energy and Environment in the Department of Electronic and Electrical Engineering at the University of Strathclyde. He also serves as the manager for the Dynamic Power Systems Laboratory at Strathclyde. He leads the International Energy Agency (IEA) ISGAN SIRFN Advanced Laboratory Testing Methods Working Group and is the Secretary of IEEE Task Force on Control of Distributed Resources in Energy Internet. He has lead and contributed to innovative National, European and Industrial power system research projects with a strong publication record of over 58 peer-reviewed scientific papers. His research interests include demand side management, decentralized and distributed control, real-time controller and power hardware in the loop simulations, geographically distributed simulations and systems level validations.



Antonello Monti (SM'02) received the M.Sc. (summa cum laude) and Ph.D. degrees in electrical engineering from the Politecnico di Milano, Milano, Italy, in 1989 and 1994, respectively. He started his career with Ansaldo Industria and then moved in 1995 to the Politecnico di Milano as an Assistant Professor. In 2000, he joined the Department of Electrical Engineering, University of South Carolina, Columbia, SC, USA, as an Associate Professor and later became a Full Professor. Since 2008, he has been the Director of the Institute for Automation

of Complex Power System, E.ON Energy Research Center, RWTH Aachen University, Aachen, Germany. Since 2019 he also has a joined appointment at Fraunhofer FIT within the Center for Digital Energy Aachen. He has authored or co-authored more than 400 peer-reviewed papers published in international journals and in the proceedings of international conferences. Dr. Monti is an Associate Editor for the IEEE ELECTRIFICATION MAGAZINE. He is a member of the Editorial Board of the Sustainable Energy, Grids and Networks, and also a member of the Founding Board of the Energy Informatics. He is the recipient of the 2017 IEEE Innovation in Societal Infrastructure Award.



Andrea Benigni (S'09-M'14-SM'20) received the B.Sc. and M.Sc. degrees from Politecnico di Milano, Milano, Italy, in 2005 and 2008, respectively, and the Ph.D. degree from RWTH-Aachen University, Aachen, Germany, in 2013. From 2014 to 2019, he was an Assistant Professor with the Department of Electrical Engineering, University of South Carolina, Columbia, SC, USA. Since 2019 he is a full professor at RWTH-Aachen and director of the institute for "Institute of Energy and Climate Research: Energy Systems Engineering (IEK-10)" at

the Juelich research center.



Shahab Karrari (S'09) was born in London, U.K., in 1990. He received his B.Sc. and M.Sc. degree in electrical power engineering from Amirkabir University of Technology (Tehran Polytechnic), in 2012 and 2014, respectively. In 2021, he was awarded a PhD degree (summa cum laude) from the Institute for Technical Physics of the Karlsruhe Institute for Technology (KIT) in Germany for his work on the integration of energy storage systems using real-time simulations. Since 2022, he is working at Siemens Energy as a control expert, working on advanced

grid support functionality of HVDC converter stations. His main research interests include power system dynamics and control, energy storage systems, HVDC systems, and hardware-in-the-loop testing.



Panos Kotsampopoulos (S'12, SM'20) received the Diploma in Electrical and Computer Engineering and his PhD degree from NTUA in 2010 and 2017 respectively. Since 2010 he has been working on research projects at the Smart RUE research group of NTUA, where he is currently a senior researcher. He was a guest researcher at the Austrian Institute of Technology AIT in 2012 and 2013. He is chair of the IEEE PES Task Force "Innovative teaching methods for modern power and energy systems" and active member of several IEEE and CIGRE Task Forces

and Working Groups. He is member of the Editorial Board of the "IEEE Open Access Journal of Power and Energy" and the journal "Energies". He is chair of the IEEE Young Professionals Greece and co-founder of the energy community "Collective Energy". His research interests include real-time simulation, control of distributed energy resources, power system dynamics and engineering education.



Md Omar Faruque (SM -2014) is an Associate Professor of FAMU-FSU College of Engineering at Florida State University. He received his Ph.D. from the University of Alberta, Canada in 2008. Since then, he has been working at the Center for Advanced Power Systems at Florida State University. In 2013, he was also appointed as a faculty with the FAMU-FSU College of Engineering. His research interest is in the area of modeling and simulation, smart grid and renewable energy integration, energy management and demand response, and ship power system design. He has published more than 100 publications including 40 in peer-reviewed journals. He has been serving as the Chair of IEEE Power and Energy Society (PES) Task Force on "Real-Time Simulation of Power and Energy System" since 2012. He is also a Co-Chair of the working group "Modeling and Analysis of System Transient using Digital Programs". Prof. Faruque is a member of other IEEE Task Forces and Working Groups. He also served as a Guest Editor of many special issues of IEEE, IET, and Energies journals.