

Article

European DEMO Fusion Reactor: Design and Integration of the Breeding Blanket Feeding Pipes

Rocco Mozzillo ^{1,*}, Christian Vorpahl ², Christian Bachmann ², Francisco A. Hernández ³
and Alessandro Del Nevo ⁴

¹ CREATE, Engineering School, Basilicata University, Campus Macchia Romana, 85100 Potenza, Italy

² EUROfusion PMU, Boltzmannstraße 2, 85748 Garching, Germany

³ Karlsruhe Institute of Technology (KIT), Institute for Neutron Physics and Reactor Technology (INR), Hermann-von Helmholtz-Platz 1, 76344 Eggenstein-Leopoldshafen, Germany

⁴ ENEA FSN-ING-PAN, ENEA CR Brasimone, Località Brasimone, 40032 Camugnano, Italy

* Correspondence: rocco.mozzillo@unibas.it

Abstract: This article describes the design and configuration of the DEMO breeding blanket (BB) feeding pipes inside the upper port. As large BB segments require periodic replacement via the upper vertical ports, the space inside the upper port needs to be maximized. At the same time, the size of the upper port is constrained by the available space in between the toroidal field coils and the required space to integrate a thermal shield between the vacuum vessel (VV) port and the coils. The BB feeding pipes inside the vertical port need to be removed prior to BB maintenance, as they obstruct the removal kinematics. Since they are connected to the BB segments on the top and far from their vertical support on the bottom, the pipes need to be sufficiently flexible to allow for the thermal expansion of the BB segments and the pipes themselves. The optimization and verification of these BB pipes inside the upper port design are critical aspects in the development of DEMO. This article presents the chosen pipe configuration for both BB concepts considered for DEMO (helium- and water-cooled) and their structural verification for some of the most relevant thermal conditions. A 3D model of the pipes forest, both for the Helium-Cooled Pebble Bed (HCPB) and Water-Cooled Lithium Lead (WCLL) concepts, has been developed and integrated inside the DEMO Upper Port (UP), Upper Port Ring Channel, and Upper Port Annex (UPA). A preliminary structural analysis of the pipeline was carried out to check the structural integrity of the pipes, their flexibility against the thermal load, their internal pressure, and the deflection induced by the thermal expansion of the BB segments. The results showed that the secondary stress on the hot leg of the HCPB pipeline was above the limit, suggesting future improvements in its shape to increase the flexibility. Moreover, the WCLL concept did not have a critical point in terms of the secondary stress on the pipeline, since the thicknesses and the diameters of these pipes were smaller than the HCPB ones.

Keywords: DEMO; Breeding Blanket; Upper Port; CAD; FEM



Citation: Mozzillo, R.; Vorpahl, C.; Bachmann, C.; Hernández, F.A.; Del Nevo, A. European DEMO Fusion Reactor: Design and Integration of the Breeding Blanket Feeding Pipes. *Energies* **2023**, *16*, 5058. <https://doi.org/10.3390/en16135058>

Academic Editor: Sung Joong Kim

Received: 24 March 2023

Revised: 8 June 2023

Accepted: 19 June 2023

Published: 29 June 2023



Copyright: © 2023 by the authors. Licensee MDPI, Basel, Switzerland. This article is an open access article distributed under the terms and conditions of the Creative Commons Attribution (CC BY) license (<https://creativecommons.org/licenses/by/4.0/>).

1. Introduction

The pre-conceptual phase of the European Demonstration Fusion Power Reactor (DEMO) has been concluded, and the integration of all the systems inside the tokamak has been a crucial activity for avoiding issues in the conceptual design phase. This includes an evaluation of the interference between the systems and their consistency with the assigned requirements. One of DEMO's most critical components is the Breeding Blanket (BB) [1–4], with the current design strategy aimed at the investigation and development of two BB concepts [5]. The connection of the BB segments to the primary heat transfer system (PHTS) and the tritium extraction and removal system (TER) [6] have been identified as important aspects, also having impacts on the design and operation of the Balance of Plant (BoP). Given this, the upper ports are foreseen for BB maintenance, the BB cooling pipes are

integrated in the upper ports as well, and, consequently, the PHTS is integrated into the upper building level [7]. In addition to the BB service pipes, other systems are integrated inside the upper ports, e.g., neutron shield plugs, plasma protection limiters, and, possibly, diagnostic systems [8]. To connect the BB feeding pipes to the PHTS ring channel and Lithium Lead (LiPb) loops outside the bioshield, an Upper Port horizontal Annex (UPA) is integrated with a penetration plate in proximity to the cryostat [9]. The aim of this work consisted of the design and integration inside the upper port of the feeding pipes, both for a Helium-Cooled Pebble Bed (HCPB) and Water-Cooled Lithium Lead (WCLL). The minimum required thicknesses of the pipe walls have been calculated according to the ASME NB-3641.1 [10] and NB-3642.1, considering a Level A service. FEM analyses have been also conducted to check the structural integrity of the pipes and to address their flexibility.

The pipes are routed inside the UPA and welded both at the penetration plate and on the backside of each BB sector (Figure 1). They are equipped with vertical pipe stubs to allow for an insertion of the remote handling tools (both for in-bore cutting and in-bore welding).

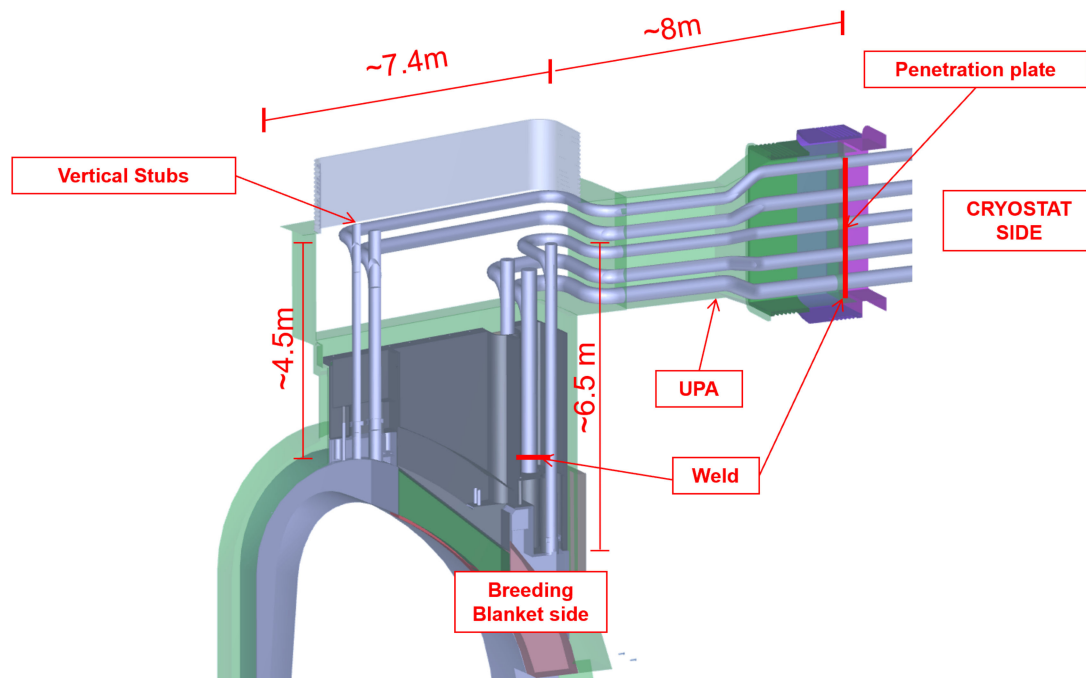

Figure 1. Pipe layout DEMO Upper Port (HCPB BB concept).

The penetration plate is part of the first confinement barrier. Since during operation, the BB sectors and pipes expand, both components exchange forces, causing secondary stresses in the pipes. Three-dimensional models of the pipe forests, both for the Helium-Cooled Pebble Bed (HCPB) and Water-Cooled Lithium Lead (WCLL) concepts, have been developed and integrated inside the DEMO Upper Port (UP), Upper Port Ring Channel, and Upper Port Annex (UPA). A preliminary structural analysis of the pipeline has been carried out to check the structural integrity of the pipes, their flexibility against the thermal load, their internal pressure, and the deflection induced by the thermal expansion of the BB segments. The results showed that the secondary stress on the hot leg of the HCPB pipeline was above the limit, suggesting future improvements in its shape to increase the flexibility. Moreover, the WCLL concept did not have a critical point in terms of the secondary stress on the pipeline, since the thicknesses and the diameters of these pipes were smaller than the HCPB ones. The DEMO plant site has not been chosen yet and due to this, it is not possible to carry out an assessment on the pipes' supports, since the values of the seismic acceleration are not available, which depend on the plant site. The outcomes of the present study will be the inputs for the future assessment on the support layout,

since they will provide information about the level of stress (both primary and secondary) in the pipes due to the thermal load, internal pressure, and displacement induced by the BB segment expansions, and the pipes' behavior under these aforementioned loads. The support system will guarantee this behavior as much as possible. Our assessment also clarified which geometrical configuration of the pipes needs to be improved, since in a "free" support configuration, the level of stress is already above the limits imposed by the code. Steel AISI 316L(N) (EN 1.4429, ASTM UNS S31653) with a low cobalt content has been provisionally chosen as the reference material for these pipes, since it is assumed the pipes will be welded to the penetration plate inside the VV UPA.

2. Design Strategy

A UP pipes integration was conducted, starting from a definition of the high-level requirements according to the Systems Engineering approach [11]. The dimensions of the pipes were chosen according to the ITER CAD manual [12] and ASME code (diameters and bending radii) [13,14] and starting from a thermohydraulic calculation of the required mass flow rate of each fluid [14–16]. The thicknesses of each pipe were preliminary dimensioned according to the ASME code, considering a design pressure 15% greater than the operating pressure [17]. The minimum required thicknesses and nominal thicknesses are reported for each pipe in Table 1. The minimum required thicknesses were calculated according to the ASME code [18]. The nominal standard thicknesses were chosen according to ASME B36.10M [13], with values higher than the corresponding minimum required thicknesses.

Table 1. Minimum required and nominal thicknesses of BB feeding pipes.

Cases	BB Concept	Segment	Fluid	Leg	Size	Minimum Required Wall Thickness [mm] [10]	Nominal Wall Thickness [mm] (ASME B36.10M-2004 [13])
1	HCPB	Inboard	Helium	HOT	DN300	14.80	15.88
2				COLD	DN250	10.86	11.13
3		Outboard		HOT	DN350	16.25	17.48
4				COLD	DN300	12.88	15.88
5	WCLL	Inboard	BZ H ₂ O	HOT	DN150	12.92	14.27
6				COLD	DN150	12.59	14.27
7		Outboard	BZ H ₂ O	HOT	DN200	16.82	18.26
8				COLD	DN200	16.39	18.26
9		Inboard	FW H ₂ O	HOT	DN100	8.77	11.13
10				COLD	DN100	8.55	11.13
11		Outboard	FW H ₂ O	HOT	DN125	10.84	12.70
12				COLD	DN125	10.57	12.70
13	Inboard	LiPb	LiPb	HOT	DN125	10.84	12.70
14				Outboard	HOT	DN200	16.82

Their layout must allow for access to each pipe by the remote handling tools [19,20]. Hence, space is required between the pipes at the levels of the cut and re-welding areas. To date, pipes with diameters of up to 90 mm have been cut and rewelded, trials have been run, and cutting tools have achieved cuts from inside pipes through 5 mm 316 L and P91 (substitute for Eurofer 97) [21]. It is clear that a remote maintenance strategy coupled with proper test campaigns is needed to develop technologies that guarantee the cutting and welding of pipes much larger in their diameters and thicknesses. The layout of these pipes must also consider the required space for the BB attachment interfaces for their replacement and manipulation [22]. The pipes are assumed to not be insulated inside the upper port,

since they are in a vacuum, while insulated on the outside of the penetration plate. The vertical legs of the pipes are equipped with vertical stubs on the top (Figure 1). These will be opened during maintenance and will allow for the insertion of in-bore pipe tools [21].

2.1. WCLL Breeding Blanket Feeding Pipes Integration

In the current configuration, each WCLL BB is cooled by water with two separate circuits, one for the First Wall (FW) and the other for the Breeder Zone (BZ) [2]. This choice has a strong impact on the number of feeding pipes inside the UP. The breeder fluid is Lithium Lead (LiPb) fed from the lower port (Figure 2); the outlet legs are positioned in the UP. This choice allows for a reduction in the number of the pipes routed in the UP and UPA.

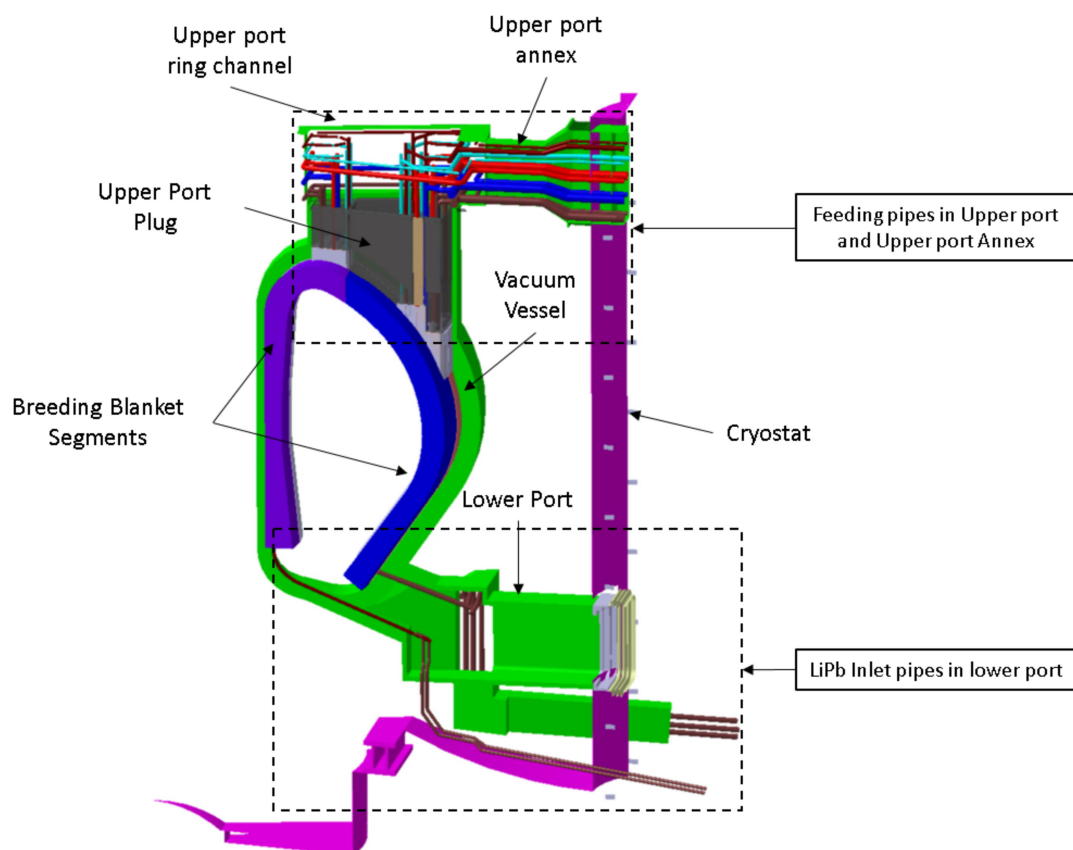

Figure 2. WCLL BB feeding pipes—VV in green, Ports in green, UP annex in green, and Cryostat in pink re cut.

In order to also reduce the number of junctions to the PHTS [20] and LiPb loops [6], the feeding pipes of both the inboard and outboard segments are collected by manifolds placed inside the Upper Port Ring Channel (UPRC). For each circuit (hot and cold legs), two manifolds are placed inside the UPRC, one collecting the feeding pipes of the two inboard segments and the second the three outboard segments (Figure 3).

According to the proposed layout, ten in-port manifolds are placed in the UPRC and UPA, as reported in (Figure 4), eight of which are dedicated to the FW and BZ cooling water and two for the LiPb outlet leg.

Five LiPb inlet pipes are placed in the lower port (Figure 2) and their nominal diameters (Table 1) are defined according to the thermohydraulic requirements [2]. The layout of these pipes and in-port manifolds is shown in (Figure 4), compliant with the assumed high-level requirements [11,12].

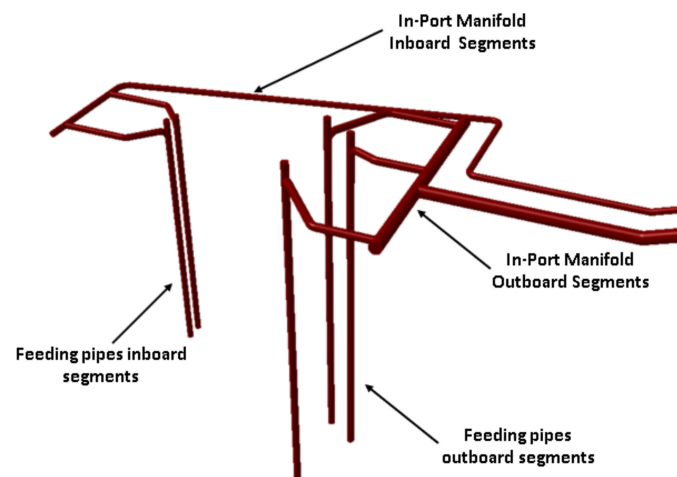

Figure 3. In-port manifolds of the WCLL outlet cooling water pipes.

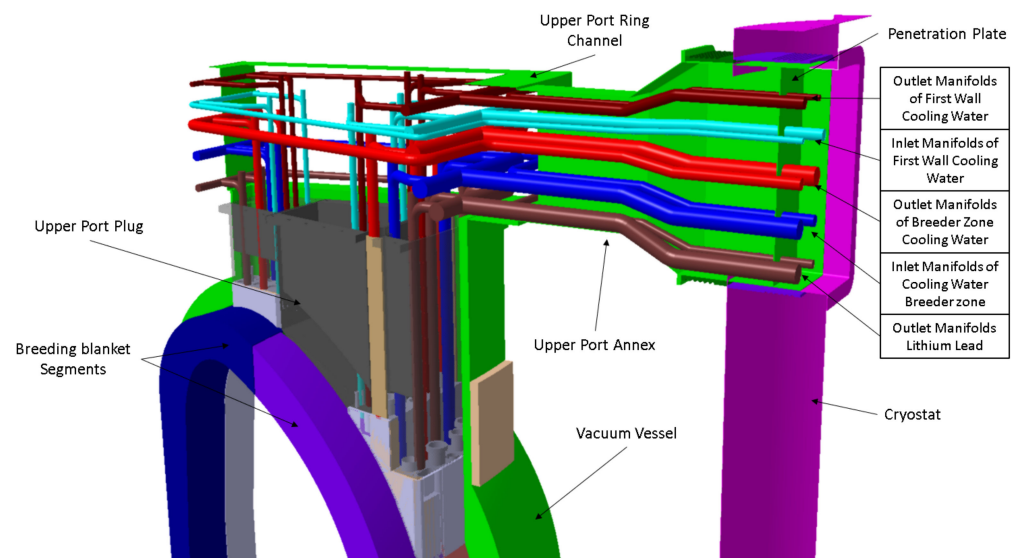

Figure 4. WCLL BB feeding pipes in Upper Port and Upper Port Annex—Vacuum Vessel Upper Port and Upper Port Annex are cut in the figure.

2.2. HCPB Breeding Blanket Feeding Pipes Integration

Since the breeder material is solid [1], the HCPB BB is fed only from the UP and no feeding pipes are needed in the lower port. Each BB segment is fed by two helium coolant pipes (inlet and outlet) and two other pipes with smaller diameters are dedicated to the purge gas for the tritium removal. The cooling pipes are joined to the PHTS legs placed in the tokamak building [20]. Given the large pipes' diameters and the space available in the UP, the pipes are not collected in the UPRC manifolds. Ten cooling pipes and ten smaller purge gas pipes are arranged in the UP (Figure 5) and the nominal diameters of these pipes are chosen according to thermohydraulic calculations, in order to assure the required flow rate [1]. As in the case of the WCLL, the piping layout of the pipes is arranged according to [12,13].

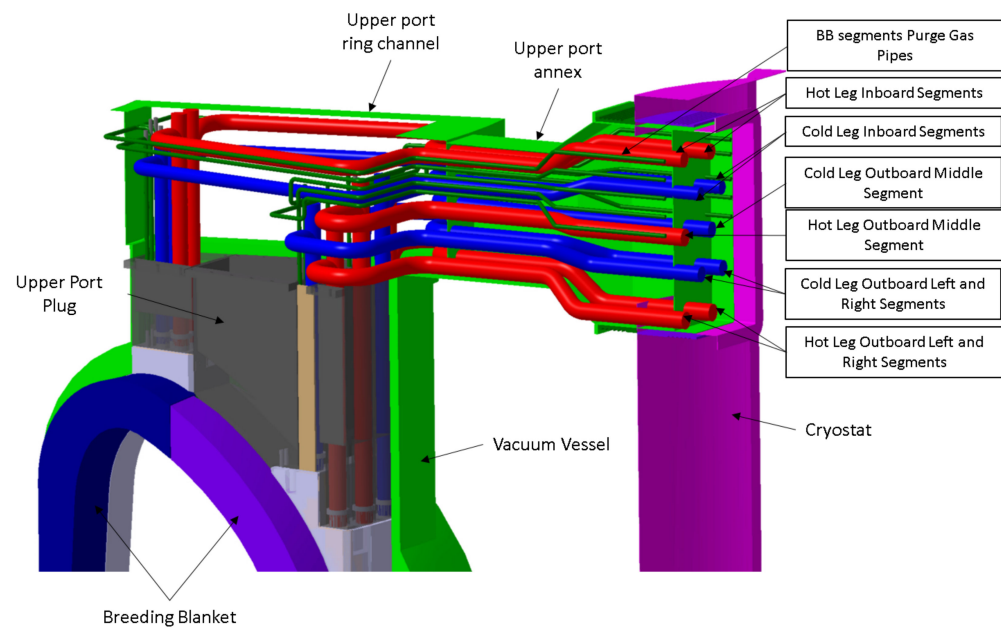

Figure 5. HCPB BB feeding pipes—Vacuum Vessel Upper Port and Upper Port Annex are cut in the image.

3. Design Criteria and Pipes Flexibility Assessment

The design criteria were assumed for the structural verification and pipe wall thickness dimensioning. Since a higher design pressure requires a higher thickness and potentially a reduced flexibility of the pipe, the goal of the activity concerned not only a structural verification of the pipes' structure, but also an assessment of their flexibility, in order to reduce the pipes' stress due to the vertical expansion of the BB segment during the operation. The outcome of the study consisted of relevant information about the pipes' shape. The structural verification was based on the following assumptions:

- The ASME Nuclear Code was chosen as the reference code;
- ASME BPVC.III.1. NB-2015 [10] was adopted for the structural verification;
- A design pressure 15% greater than the operating pressure [17];
- A design temperature +25 °C greater than the operating value [17];
- Creep phenomena were neglected in the current stage of the design, since the operating temperature of all the pipes was lower than 450 °C (Table 2), except for the helium hot leg. As a conservative assumption, it was assumed that the helium hot leg worked at 500 °C for a time lower than 10,000 h;
- Level A service level was assumed [10];
- Seismic accelerations were neglected, since they could be reduced by an adequate design of the pipe supports and depended on the plant site, which was not yet defined and not in the scope of the work;
- The dead weight of the fluids was neglected, since it could be estimated as a few kilograms per linear meter for the water, lower than a kilogram per linear meter for the helium, and about hundred kilograms per linear meter in the case of the lithium lead;
- The dynamic loads, due to the movement of the fluid inside, were currently neglected.

The structural verification of the pipes was based on the thermohydraulic calculations [1,2] of both BB concepts (HCPB and WCLL). The hydraulic diameter was defined for each pipe to assure the required coolant flow rate, then the nominal diameter was approximated for a reference standard (Table 1). Steel AISI 316L(N) (EN 1.4429, ASTM UNS S31653) [10] with a low cobalt content was provisionally chosen as the reference material for the pipes [16]. The minimum pipe wall thicknesses were defined according to the ASME code, considering the design pressure as the load. The values of the thicknesses obtained

were approximated using those from the ASME and EN reference standards [13,14] and are reported in Table 1.

Table 2. Boundary conditions applied for FEM calculations.

BB Concept	Leg	FLUID	Operating Pressure [bar]	Design Pressure [bar]	Operating Temperature [°C]	Design Temperature [°C]	VV Operating Temperature [°C] [23]
HCPB	HOT	HELIUM	80	92	500	525	40
HCPB	COLD	HELIUM	80	92	300	325	40
WCLL	HOT	Water	155	178	328	353	40
WCLL	COLD	Water	155	178	295	320	40
WCLL	HOT/COLD	LiPb	46	178 *	326	351	40

* in case of BB in-box LOCA it is assumed the LiPb will be pressurized, for this reason 178 bar was assumed as design pressure also in this case.

The following boundary conditions were considered in the FEM analyses: (i) the operating pressure of the coolant; (ii) the pipe operating temperature; and (iii) the BB segment deformation and consequent movement of the pipe interface (location “BB side”—Figure 6), i.e., the vertical displacement and rotation about the toroidal axis.

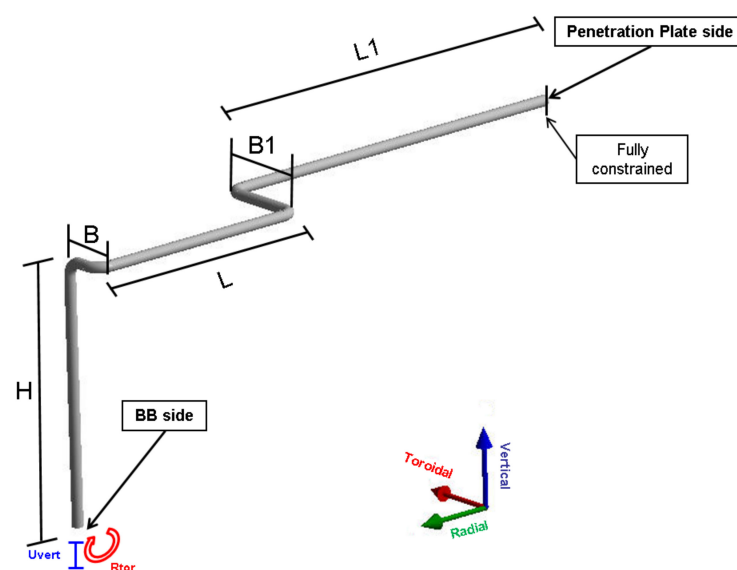

Figure 6. Boundary conditions of FEM model.

As in the case of an ITER Upper Port bulkhead, the pipes were assumed to be fully constrained at the level of the penetration plate [24]. Given the operating temperature of the DEMO vacuum vessel (VV) [20], this was recently defined as ~ 50 °C. The thermal expansion of the VV was only moderate and beneficial for the stresses in the pipes. It was (conservatively) neglected in this work. In [23], the BB deformation was estimated. The BB segments were assumed to be vertically constrained to the VV on the bottom [25] and their thermal expansion was allowed, to some degree, on the top by the assembly gaps. According to the outcomes of [24], the pipe interfaces of the inboard segments (location “BB side” in Figure 6) were predicted to move upwards by 70 mm and those on the outboard segments by 110 mm (Table 3). In addition, the pipe interfaces also rotated by $\approx 0.6^\circ$. The reference temperature considered for the thermal calculations was 50 °C, as was the vacuum vessel operating temperature [23], since the pipes were welded to the penetration plate that was part of the DEMO vacuum vessel.

Table 3. Vertical displacement and toroidal rotation applied at level of BB backwall—“BB side” Figure 6 [24].

Component	Vertical Displacement [mm]	Toroidal Rotation [°]
BB inboard segments	70	0.6
BB outboard segments	110	−0.6

4. Results

A parametric FE beam model was used to assess and optimize the different configurations of the pipes. The software used was ANSYS 15.0. ASME NB-3641.1 and NB-3642.1 [10] were used as reference codes for the dimensioning of the minimum wall thicknesses. The resulting sizes and minimum thicknesses were standardized according to the EN-10220:2016 [14].

The results of the analyses showed that the relative movement of the pipes was mainly caused by: (i) the thermal expansion of the pipe itself, and (ii) the assigned rotation and displacement due to the BB segments’ thermal expansion. The outcomes of the analysis also showed that the pipes must be designed with bends to increase their flexibility and that the penetration plate should be moved radially towards the end of the upper port horizontal annex. Additionally, the implementation of a bend made the toroidal pipes section act in torsion and increase the pipes’ flexibility. Nonetheless, the relatively high stiffness of the thick-walled pipes, which were designed to withstand the high operating pressure of the BB coolant, generated high reaction forces on the pipe supports. According to the assumed loads and boundary conditions, the secondary stress was proportional to the pipe diameter and thickness, which were inversely proportional to the internal pressure. The secondary stress depended on the pipe constraints, their shape, and their cross-section. The stress level in the smaller water cooling pipes was therefore generally uncritical, whereas that in the large helium cooling pipes was very high, in particular in the hot legs.

Figures 7 and 8 show the secondary stress and radial deformation in the load case “1”, see Table 4, and the critical load cases for the HCPB feeding pipes. The highest stress occurred at the interface to the BB back surface (Figure 7) and was mainly due to the thermal deformation of the pipe’s radial leg. The maximum radial displacement of the inboard segments leg was about 94 mm (Figure 8). In this configuration, the stress due to the thermal deformation of the pipe itself was about the 75% of the total, while the other was related to the expansion of the BB segment. In order to reduce the stress in the pipe, it will be necessary to act upon the flexibility of the pipe’s vertical leg, increasing, for example, the length of the toroidal leg and adding, where possible, “U”-shaped parts.

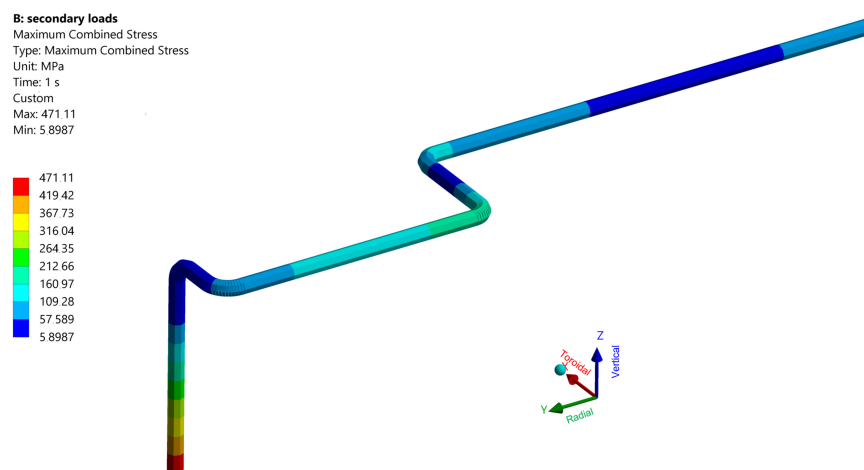
**Figure 7.** Secondary stress in the helium outlet cooling pipe of the inboard HCPB BB segment, Case 1 (Table 4).

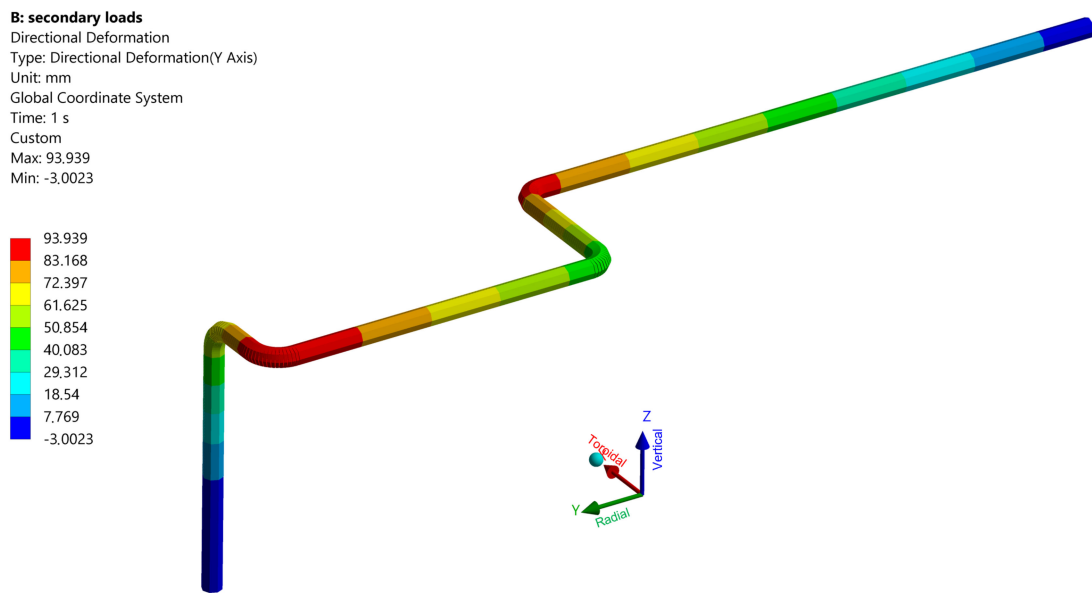

Figure 8. Radial displacement in the helium outlet cooling pipe of the inboard HCPB BB segment, Case 1 (Table 4).

Table 4. Results of FEM analyses and structural integrity verification according to ASME NB 3222-1 [13] Green shows the load cases where the stress is below the limits, red shows the values of the stress above the limits.

Case	BB	Segment	Fluid	Leg	Size	L [m]	B [m]	L1 [m]	B1 [m]	H [m]	Sm	1.5 Sm [Mpa]	3 Sm [Mpa]	Pe + Q [Mpa]	Pl + Pb [Mpa]	Pl + Pb + Pe + Q [Mpa]		
1	HCPB	inboard	Helium	HOT	DN300	6	2	10	2.5	4.5	97	145.5	291	472.05	56.61	528.66		
COLD				DN250	112						168	336	290.29	69.00	359.28			
outboard		HOT		DN350	2	8		6.5		97	145.5	291	333.53	44.49	378.02			
		COLD		DN300						112	168	336	248.80	44.90	293.71			
5	WCLL	inboard	BZ Water	HOT	DN150	6	2	10	2.5	4.5	109	163.5	327	191.54	73.71	265.93		
COLD				DN150	112						168	336	180.72	73.71	254.43			
outboard		HOT		DN200	2	8		6.5		109	163.5	327	179.80	48.09	227.89			
		COLD		DN200						112	168	336	173.25	48.09	221.35			
9	WCLL	inboard	FW Water	HOT	DN100	6	2	10	2.5	4.5	109	163.5	327	131.12	111.46	242.59		
COLD				DN100	112						168	336	123.28	111.46	234.74			
outboard		HOT		DN125	2	8		6.5		109	163.5	327	116.90	49.93	166.83			
		COLD		DN125						112	168	336	112.64	49.93	162.57			
13	WCLL	inboard	LiPb	HOT	DN200	6	2	10	2.5	4.5	109	163.5	327	161.16	88.78	249.93		
14		outboard		HOT	DN200						8	6.5	109	163.5	327	179.41	48.09	227.50
15	WCLL	In-Port Manifold	BZ Water	HOT	DN350	2		2		10	2.5	6.5	109	163.5	327	293.32	55.67	348.99
16				COLD	DN350								8	6.5	109	163.5	327	283.20

Figures 9 and 10 show the secondary stress and radial deformation in the load case “5”, see Table 4, which is a representative load case for WCLL feeding pipes. If the design pressure was 178 bar and the temperature was near to 300 °C, the level of secondary stress was quite below the limit imposed by the code, which was mainly due to the reduced diameter and thickness of the pipe and thus to the increased flexibility of the pipe itself. Additionally, in this case, the higher value of stress was at the level of the BB back plate, and the maximum radial was about 55 mm at the level of the two horizontal elbows.

In Table 4, the results in terms of the primary and secondary stresses are shown. The higher diameter and therefore stiffness of the HCPB pipes, together with the higher design temperature, generated a higher level of secondary stress, while in the case of the WCLL feeding pipes, the stresses (primary and secondary) were below the limits, except for the largest in-port outboard manifolds, where the secondary stress was just above the 3 Sm limit. It should be noted that the overall configuration of the WCLL with all the pipes and manifolds was not analyzed with a dedicated model. With the currently defined shape of the HCPB pipes, the stress level was reduced significantly; however, further increases in

the pipe flexibility are needed to meet the structural integrity criteria (Figure 9). Alternative concepts for increasing the flexibility of the HCPB pipes might be considered, such as pipe bellows [2], even if no references for this kind of application have been found. The use of bellows for high-pressure and high-temperature pipes needs to be investigated by a dedicated research project with an annexed test campaign for the characterization of the design solution.

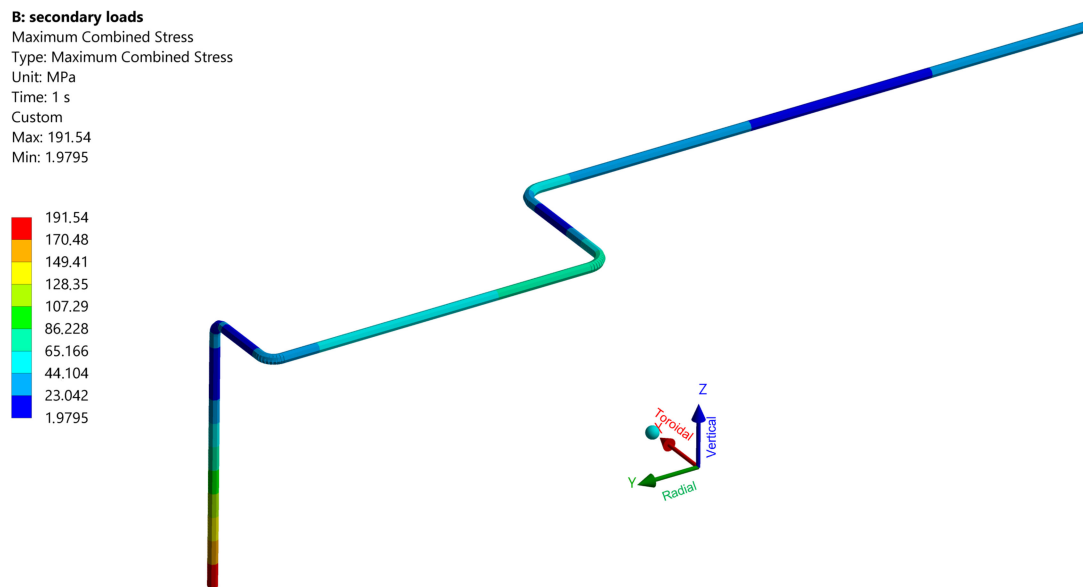

Figure 9. Secondary stress—helium outlet cooling pipe inboard WCCL BB segment, Case 5 (Table 4).

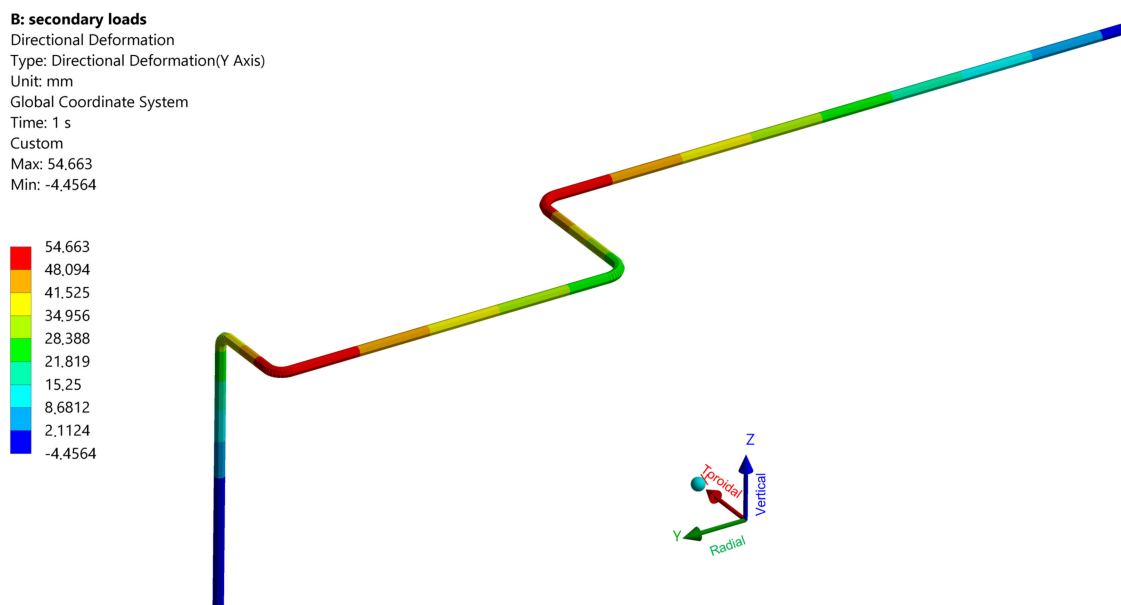

Figure 10. Radial displacement—water outlet cooling pipe inboard WCCL BB segment, Case 5 (Table 4).

5. Conclusions

A design and integration of the BB feeding pipes for both WCLL and HCPB were proposed here, the pipe wall thicknesses were dimensioned according to the ASME code, and the flexibility of the pipes was also checked considering the displacement and rotation caused by the BB segment expansion during the operation. AISI 316L(N) (EN 1.4429, ASTM UNS S31653) [10] was considered as the material for the pipes in the UP. Seismic loads were

not considered in the present study, since the location of the DEMO plant has not been chosen yet and, consequently, the acceleration spectra are unknown; this aspect needs to be addressed in parallel with the pipes' support layout.

WCLL: The WCLL pipes in the upper port were found to be feasible, provided that the radial location of the upper port annex penetration plate was at the level of the cryostat cylinder (radial coordinate ~20 m). The highest secondary stress occurred at the "in-port manifold" and was just above the limit. It is expected that moderate design adjustments will allow for the criteria to be met.

HCPB: The inlet pipes of the HCPB were found to be feasible due to the implementation of bends and their lower temperature, causing a reduced level of secondary stress. The HCPB hot legs, however, were not found to meet the design criteria regarding secondary stress, due to the high design temperature coupled with the high stiffness of the pipes with larger diameters. The pipes of the outboard BB segments generally saw a lower level of stress (~30% above the allowable) with respect to the inboard BB (~80% above the allowable).

For future development, we recommend the following: (i) steels with a higher yield strength and therefore a larger elastic range should be considered; (ii) due to the relatively low number of thermal cycles (~20,000), fatigue is not expected to be a major issue, so the pipes and their joints need not be verified against fatigue damage; and (iii) although thermal expansion is a common issue in piping and the use of bellows [26] could be suggested to increase the flexibility of the pipes, the authors point out the fact that no real application has been found where bellows are integrated into high-pressure and high-temperature pipes to increase their flexibility. The possibility of equipping these pipes with bellows is therefore not recommended, due to concerns regarding the reliability of the bellows themselves. Other studies might be conducted to: analyze the trade-off between the pipes' flexibility and aspects related to the remote maintenance and space availability inside the Upper Port, design the pipes' support and their layout, and assess the pipes' design against the seismic loads once the support scheme has been defined. The study conducted also suggests levelling out at two different diameters the pipes in the upper port, in order to reduce the impact of this variation on the design of the remote handling tools.

Author Contributions: Conceptualization, R.M. and C.V.; methodology, R.M. and C.B.; validation, F.A.H. and A.D.N.; writing—original draft preparation, R.M.; supervision, C.B. All authors have read and agreed to the published version of the manuscript.

Funding: This research was funded by European Union via the Euratom Research and Training Programme grant number 101052200—EUROfusion And The APC was funded by CREATE consortium.

Data Availability Statement: Not applicable.

Acknowledgments: This work has been carried out within the framework of the EUROfusion Consortium, funded by the European Union via the Euratom Research and Training Programme (Grant Agreement No 101052200—EUROfusion). Views and opinions expressed are however those of the author(s) only and do not necessarily reflect those of the European Union or the European Commission. Neither the European Union nor the European Commission can be held responsible for them.

Conflicts of Interest: The authors declare no conflict of interest.

References

1. Hernández, F.A.; Pereslavitsev, P.; Zhou, G.; Neuberger, H.; Rey, J.; Kang, Q.; Boccaccini, L.V.; Bubelis, E.; Moscato, I.; Dongiovanni, D. An enhanced, near-term HCPB design as driver blanket for the EU DEMO. *Fusion Eng. Des.* **2019**, *146*, 1186–1191. [[CrossRef](#)]
2. Del Nevo, A.; Arena, P.; Caruso, G.; Chiovaro, P.; Di Maio, P.; Eboli, M.; Edemetti, F.; Forgiione, N.; Forte, R.; Froio, A.; et al. Recent progress in developing a feasible and integrated conceptual design of the WCLL BB in EUROfusion project. *Fusion Eng. Des.* **2019**, *146*, 1805–1809. [[CrossRef](#)]
3. Mozzillo, R.; Del Nevo, A.; Martelli, E.; Di Gironimo, G. Rationale and method for design of DEMO WCLL breeding blanket poloidal segmentation. *Fusion Eng. Des.* **2017**, *124*, 664–668. [[CrossRef](#)]

4. Mozzillo, R.; Del Nevo, A.; Martelli, E.; Di Gironimo, G. Alternative design of DEMO Water Cooled Lithium Lead internal structure. *Fusion Eng. Des.* **2019**, *146*, 1056–1059. [[CrossRef](#)]
5. Cismondi, F.; Boccaccini, L.; Aiello, G.; Aubert, J.; Bachmann, C.; Barrett, T.; Barucca, L.; Bubelis, E.; Ciattaglia, S.; Del Nevo, A.; et al. Progress in EU Breeding Blanket design and integration. *Fusion Eng. Des.* **2018**, *136*, 782–792. [[CrossRef](#)]
6. Mozzillo, R.; Uti, M.; Venturini, A.; Tincani, A.; Gliss, C. Integration of LiPb loops for WCLL BB of European DEMO. *Fusion Eng. Des.* **2021**, *167*, 112379. [[CrossRef](#)]
7. Gliss, C.; Ciattaglia, S.; Korn, W.; Moscato, I. Initial layout of DEMO buildings and configuration of the main plant systems. *Fusion Eng. Des.* **2018**, *136*, 534–539. [[CrossRef](#)]
8. Vorpahl, C.; Mozzillo, R.; Bachmann, C.; Di Gironimo, G. Initial configuration studies of the upper vertical port of the European DEMO. *Fusion Eng. Des.* **2019**, *146*, 2469–2473. [[CrossRef](#)]
9. Marzullo, D.; Bachmann, C.; Coccorese, D.; Di Gironimo, G.; Mazzone, G.; You, J. Systems engineering approach for pre-conceptual design of DEMO divertor cassette. *Fusion Eng. Des.* **2017**, *124*, 649–654. [[CrossRef](#)]
10. *BPVC.III.1 NB-2015*; Section III 2015 ASME Boiler and Pressure Vessel Code Division 1—Subsection NB. ASME: Washington, DC, USA, 2015.
11. Marzullo, D.; Di Gironimo, G.; Lanzotti, A.; Mazzone, G.; Mozzillo, R. Design Progress of the DEMO Divertor Locking System According to IPADeP Methodology. *Procedia CIRP* **2015**, *34*, 56–63. [[CrossRef](#)]
12. Lentini, G.; Mann, J.; (ITER Organization, Cadarache, France); Teillier, L.; (ITER Organization, Cadarache, France). CAD Manual—Section 12-2 Piping Design Guidelines. ITER_D_33WL3N v. 1.2. Private Communication, 2017.
13. *ASME B36.10M-2004*; Welded and Seamless Wrought Steel Pipe. ASME: Washington, DC, USA, 2004.
14. *EN-10220:2016*; Seamless and Welded Steel Tubes—Dimensions and Masses Per Unit Length. ISO: Geneva, Switzerland, 2016.
15. Arena, P.; Bongiovì, G.; Catanzaro, I.; Ciurluini, C.; Collaku, A.; Del Nevo, A.; Di Maio, P.A.; D’Onorio, M.; Giannetti, F.; Imbriani, V.; et al. Design and Integration of the EU-DEMO Water-Cooled Lead Lithium Breeding Blanket. *Energies* **2023**, *16*, 2069. [[CrossRef](#)]
16. D’Amico, S.; Di Maio, P.A.; Jin, X.Z.; Gonzalez, F.A.H.; Moscato, I.; Zhou, G. Preliminary thermal-hydraulic analysis of the EU-DEMO Helium-Cooled Pebble Bed fusion reactor by using the RELAP5-3D system code. *Fusion Eng. Des.* **2020**, *162*, 112111. [[CrossRef](#)]
17. Barucca, L.; (EUROfusion Organization, Munich, Germany). Meeting with CREATE and Ansaldo Nucleare to define methodology for HCPB BB and WCLL BB PHTS piping thickness evaluation and material selection, 23/03/2017, EFDA_D_2NAU6V. Private Communication, 2017.
18. Kirk, S.; Keogh, K.; Suder, W.; Tremethick, T.; Allen, C.; Farquhar, I. Remote in-bore laser cutting and welding tools for use in future nuclear fusion reactors. In Proceedings of the Waste Management Symposia, Phoenix, AZ, USA, 18–22 March 2018; pp. 18–22.
19. Tremethick, T.; Kirk, S.; Keogh, K.; O’Hare, A.; Harford, E.; Quirk, B. Service Joining Strategy for the EU DEMO. *Fusion Eng. Des.* **2020**, *158*, 111724. [[CrossRef](#)]
20. Tarallo, A.; Moscato, I.; Bubelis, E.; Barucca, L. Preliminary CAD implementation of EU-DEMO primary heat transfer systems for HCPB breeding blanket option. *Fusion Eng. Des.* **2019**, *146*, 2062–2065. [[CrossRef](#)]
21. Keep, J.; Wood, S.; Gupta, N.; Coleman, M.; Loving, A. Remote handling of DEMO breeder blanket segments: Blanket transporter conceptual studies. *Fusion Eng. Des.* **2017**, *124*, 420–425. [[CrossRef](#)]
22. Udintsev, V.; (ITER Organization, Cadarache, France); Pak, S.; (ITER Organization, Cadarache, France). System Design Description (DDD) 55. U0 Up Port Systems. ITER_IDM_33D8FB. Private Communication.
23. Haertl, T.; Bachmann, C.; Diegele, E.; Federici, G. Rationale for the selection of the operating temperature of the DEMO vacuum vessel. *Fusion Eng. Des.* **2019**, *146*, 1096–1099. [[CrossRef](#)]
24. Vizvary, Z.; Arter, W.; Barrett, T.; Calleja, D.; Firdaouss, M.; Gerardin, J.; Kovari, M.; Maviglia, F.; Richiusa, M. DEMO First Wall misalignment study. *Fusion Eng. Des.* **2019**, *146*, 2577–2580. [[CrossRef](#)]
25. Bachmann, C.; Gliss, C.; Härtl, T.; Hernandez, F.; Maione, I.; Steinbacher, T.; Vizvary, Z. Mechanical support concept of the DEMO breeding blanket. *Fusion Eng. Des.* **2021**, *173*, 112840. [[CrossRef](#)]
26. Babin, B.R.; Peterson, G.P. Experimental Investigation of a Flexible Bellows Heat Pipe for Cooling Discrete Heat Sources. *J. Heat Transf.* **1990**, *112*, 602–607. [[CrossRef](#)]

Disclaimer/Publisher’s Note: The statements, opinions and data contained in all publications are solely those of the individual author(s) and contributor(s) and not of MDPI and/or the editor(s). MDPI and/or the editor(s) disclaim responsibility for any injury to people or property resulting from any ideas, methods, instructions or products referred to in the content.