

Results of ASTEC-Na KASOLA pre-test analysis

Institute for Neutron Physics and Reactor Technology

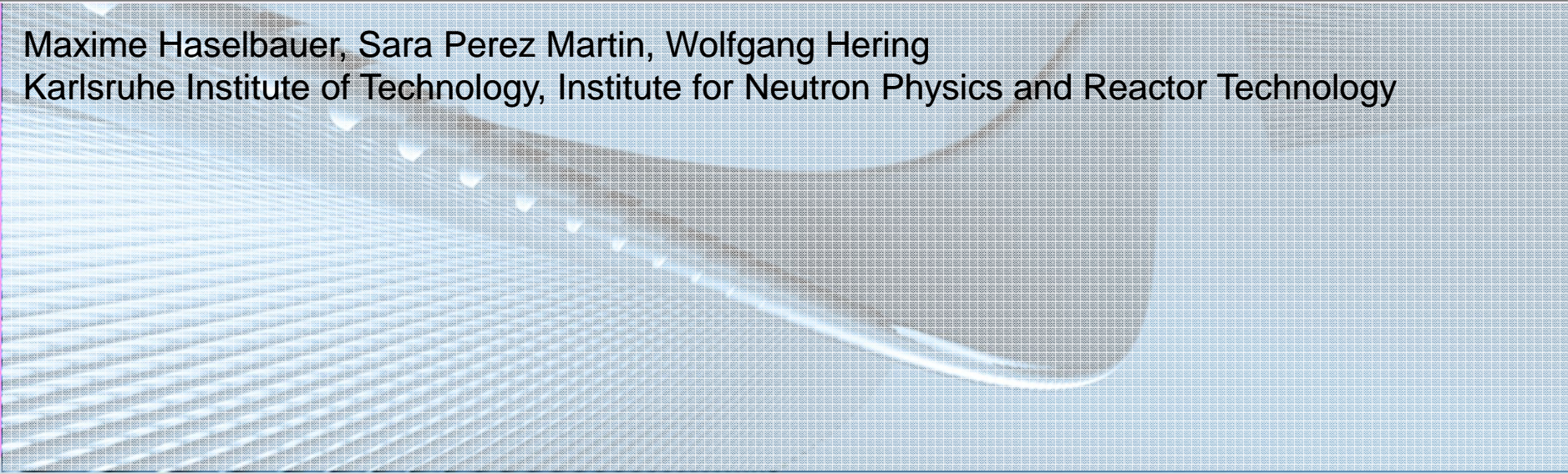

Maxime Haselbauer, Sara Perez Martin, Wolfgang Hering
Karlsruhe Institute of Technology, Institute for Neutron Physics and Reactor Technology

Simulation definition

- S1: Steady-state operation
 - Constant mass-flow
 - Constant heat-flux at heater
 - Constant mass-flow and inlet temperature at air heat-exchanger
- S2: Unprotected Loss-of Flow
 - Abrupt pump-trip (0 inertia)
- S3: Unprotected Loss of Heat-Sink
 - Abrupt loss of air feeding (100% to 0 % in 1 second)
- S4: Regulated temperature
 - Temperature is maintained constant at initial conditions (heat regulation)

S1: Steady state operation

- Initial and boundary conditions:
 - Heater power 400 kW
 - Pump-head 2.5 bar
 - Air inlet temperature 60 °C
 - Air flow-rate 6350 kg/h (1.764 kg/s)
 - Ambient temperature 60°C
 - Initial sodium temperature 300°C
 - Expansion tank pressure 2.5 bar
- Goal
 - Evaluate heat removal capacity
 - Evaluate heat losses from primary circuit
 - Reference computation for S2 and S3

S2: Loss Of Flow

- Initial and boundary conditions:
 - Same as S1 except:
 - Pump-head falls instantaneously to 0 at $t=t_{\text{LOF}}$
- Goal
 - Characterize the transition from forced to natural circulation
 - Which mass-flow is reached
 - Rapidity at which the mass-flow is being reached
 - Temperature spikes in the sodium

S3: Loss Of Heat Sink

- Initial and boundary conditions
 - Same as S1 except:
 - Air feeding at heat-exchanger stops in 1s
 - Sodium pump-head and heater power remains constant
- Goal
 - Characterize thermal inertia of the primary circuit
 - Rapidity of sodium heat-up
 - Evolution of heat losses through insulation

S4: Regulated temperature

- Initial and boundary conditions
 - Same as S1 except:
 - Power of the heater is regulated in order to maintain a constant 300°C in the circuit
- Goal
 - Steady state heat losses at initial conditions
 - Heat removal capacity at initial conditions

Modeling

- Schematic of the primary circuit
- The modeled circuit features
 - MHD Pump
 - Heater
 - Expansion Tank
 - Cooler
 - 3 Valves
- Both primary and secondary circuit are made with succession of “VOLUME” and “JUNCTIONS” structures
- Code to code comparison of the primary circuit has been performed against TRACE V5
- Simulation only address single phase thermal-hydraulic (CESAR module)

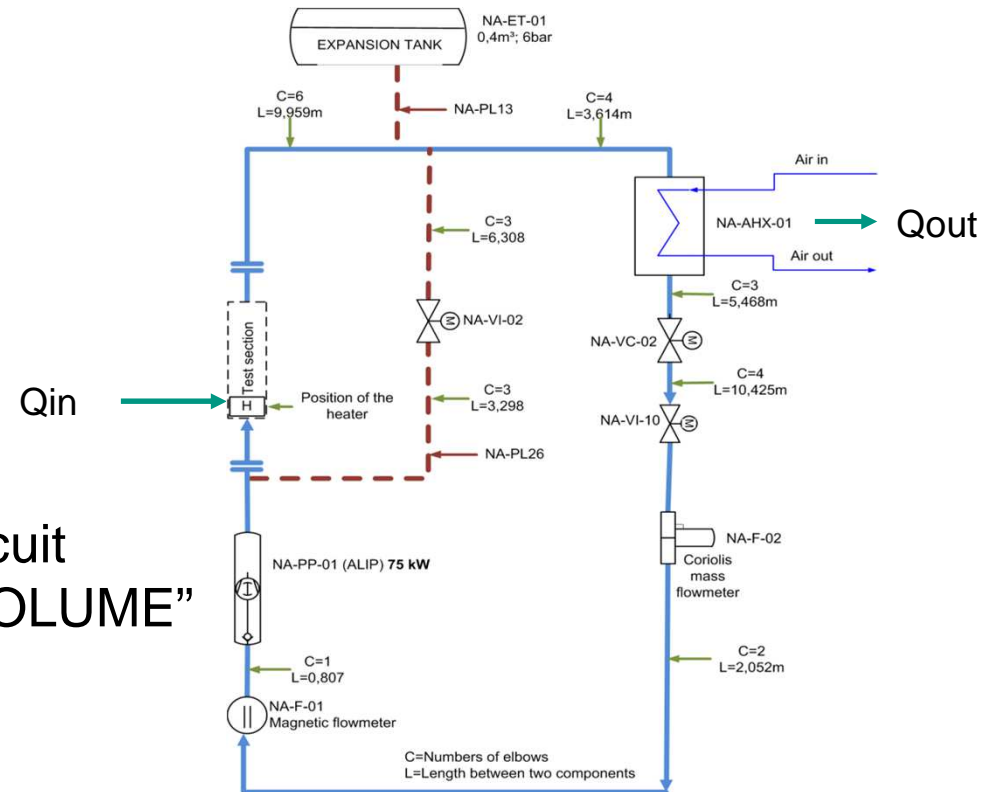

Modeling – Boundary conditions

- Following issue have been encountered during the modeling
 - Problem when trying to define an air mixture in the secondary circuit, hence N₂ has been used as the cooling gas
 - Because it is not possible to create a heat exchange from one wall to another, the several insulation layer have been replaced by only one equivalent layer.

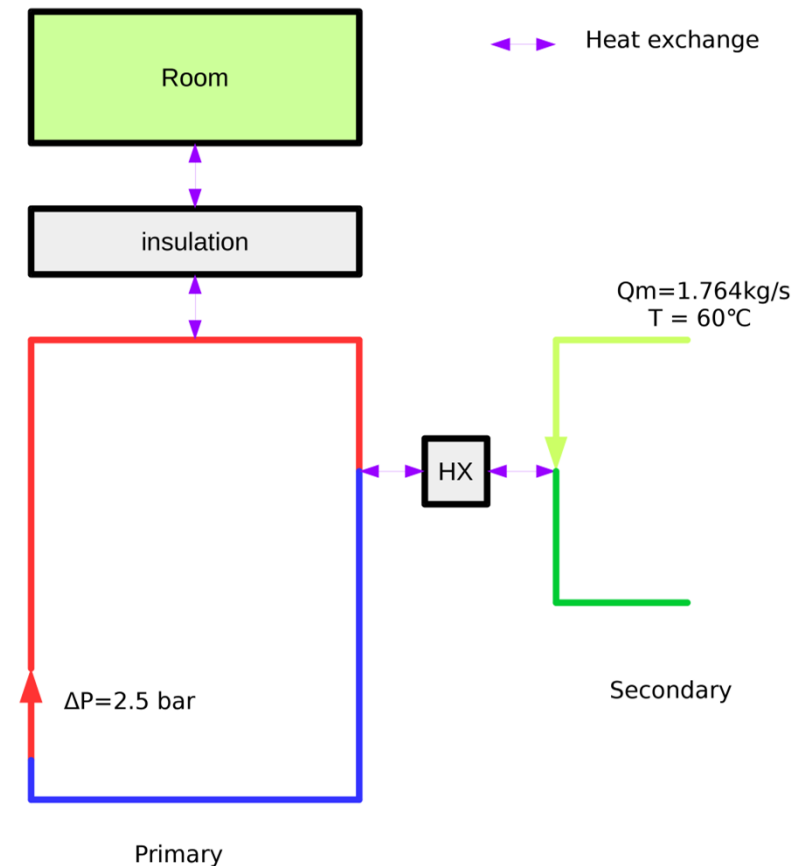

Modeling – Boundary conditions

- Insulation consist in five layers

Layer	λ	C_p	ρ	Thick (mm)
1	16,3	500	8000	2,8
2	0,09	950	160	25
3	0,039	950	60	60
4	0,039	950	60	80
5	0,037	950	60	40

Properties of insulation layers

Layer	λ	C_p	ρ	Thick (mm)
1	0,042	675.25	165.62	207.8

Simulation results: S1

- The heat removal capacity of the secondary circuit is lower than the heater power. The sodium is hence heating-up during the transient
- The initial heat removal capacity of the heat exchanger, for the given initial conditions is about 306 kW

Air-sodium heat exchanger temperature

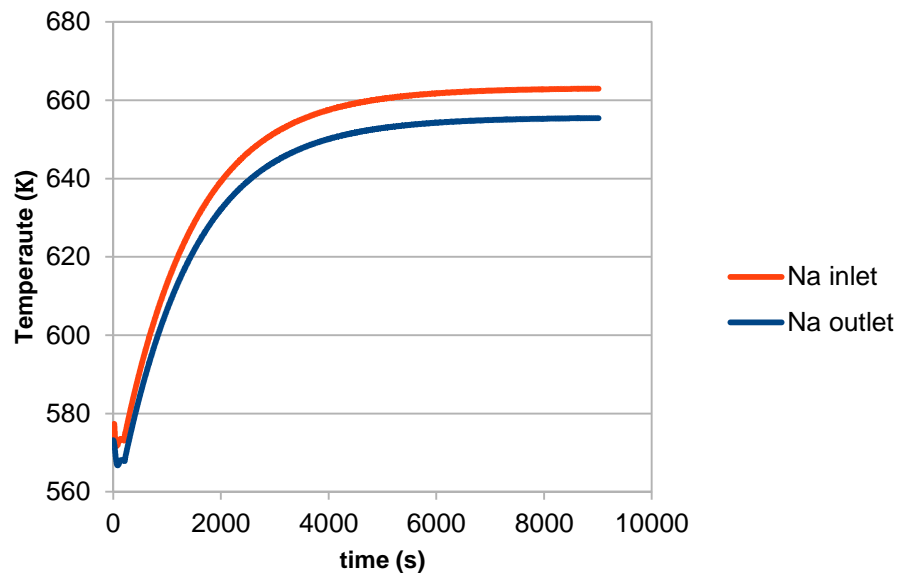

Air-Sodium cooler heat-flux

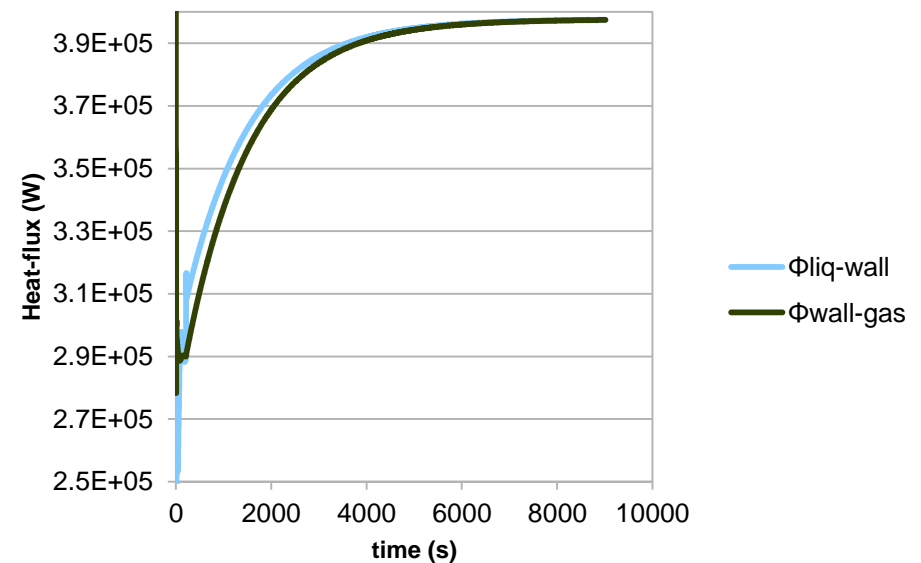

Simulation results: S1

- Unexpected:
 - When the transient begins at 200 s, the outside temperature of the insulation material decreases. This causes the temperature and pressure in the rotunda to slightly decrease.
- Impact is negligible but the behavior is unexpected

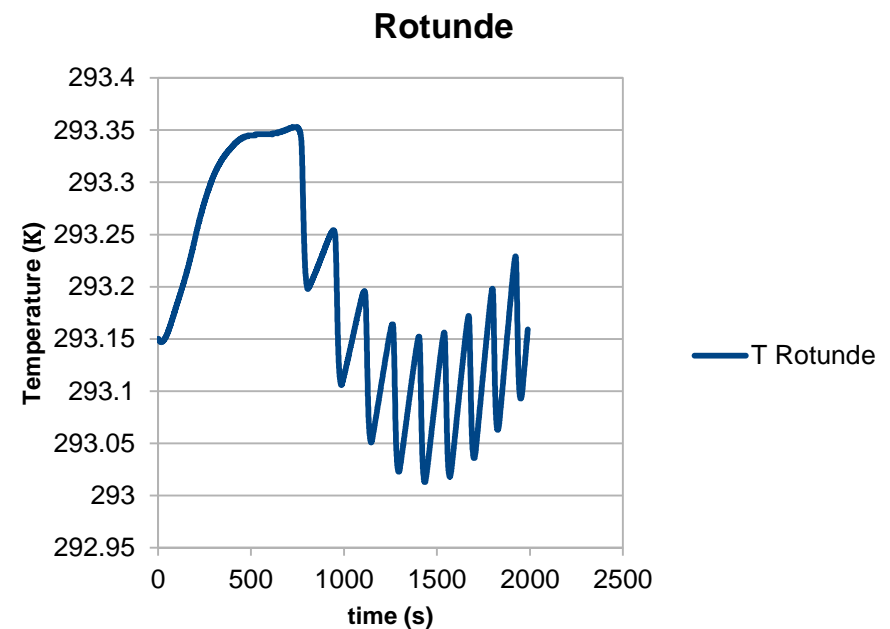
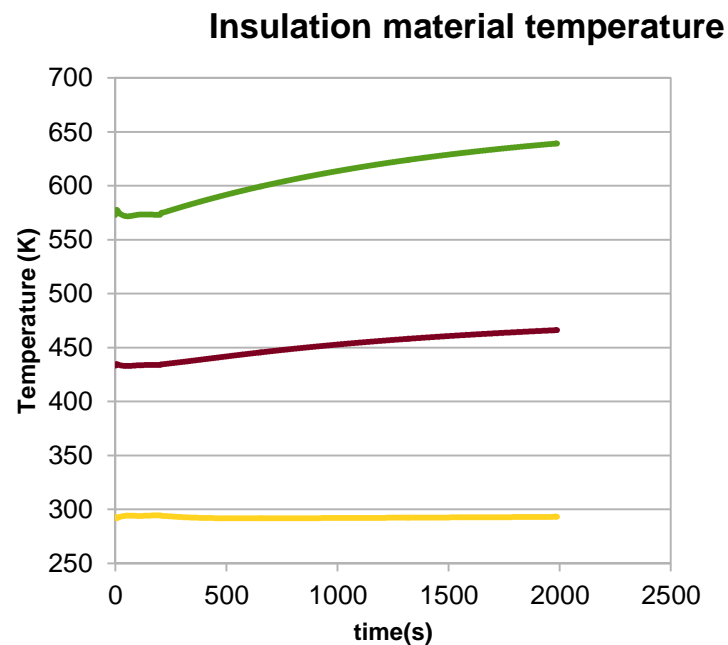

Simulation results: S2

- Sharp temperature increase at ULOF

Air-sodium heat exchanger temperature

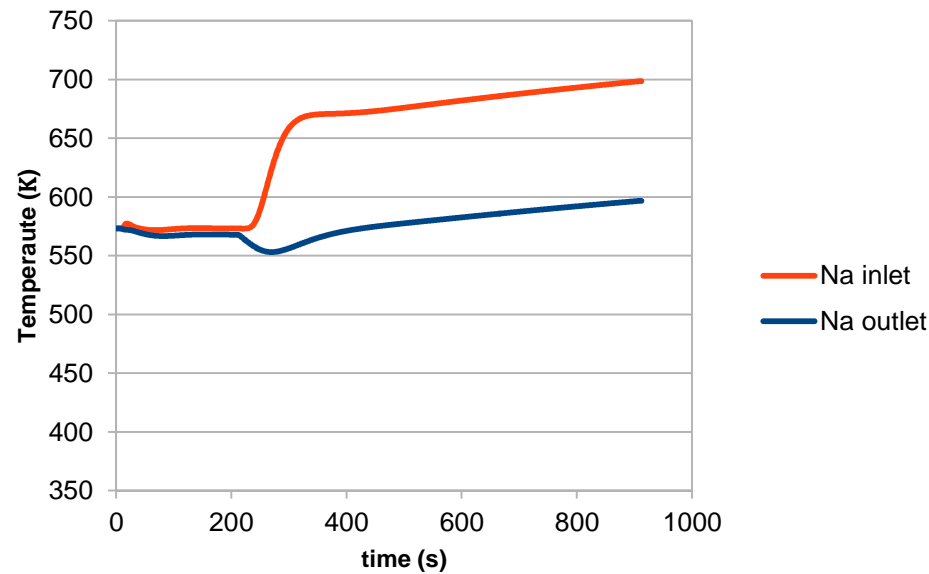

Sodium heater temperatures

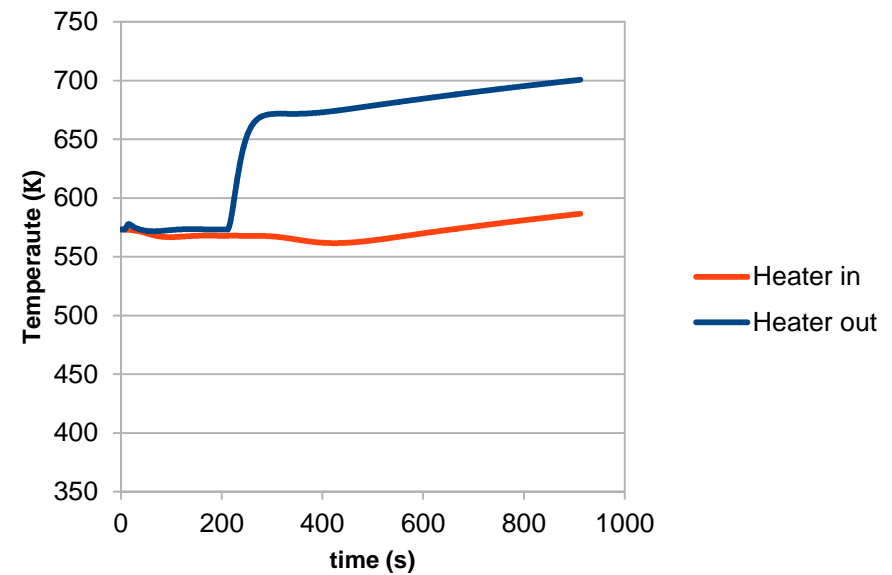

Simulation results: S2 (ULOF)

- Final mass flow in primary 2.69 kg/s

Sodium heater ΔT

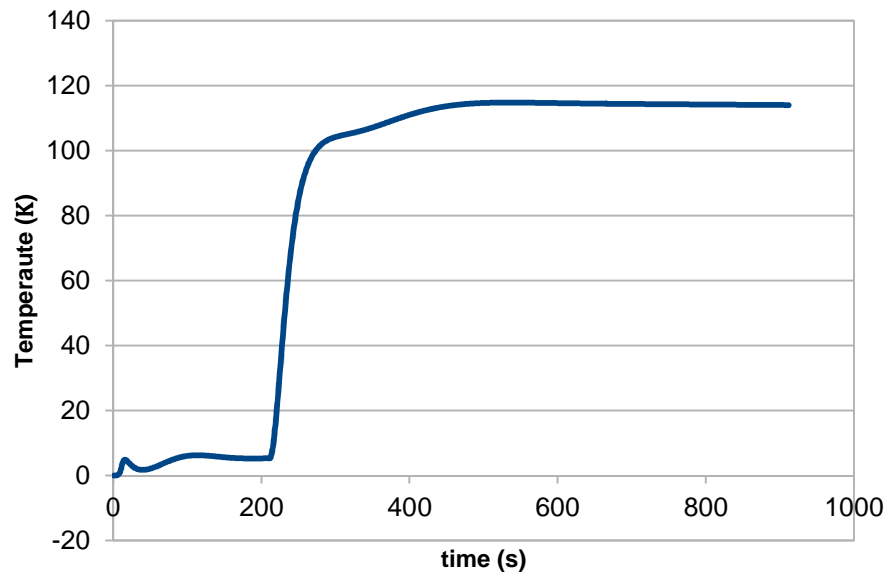

Mass-flow

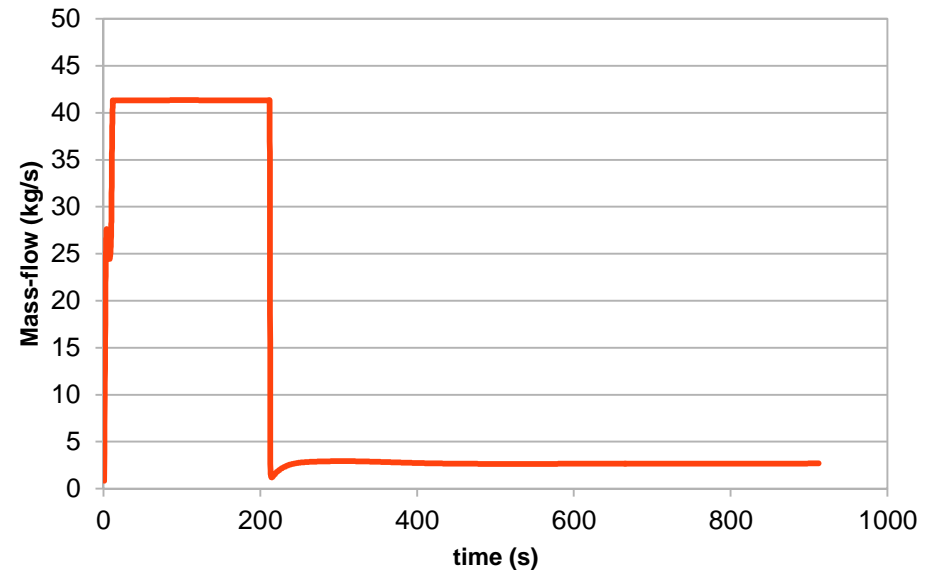

Simulation results: S3 (ULOHS)

- The air temperature raises up by 85°C compared to initial conditions
- Afterward constant increase at $0.24^{\circ}\text{C}\cdot\text{s}^{-1}$

Air-sodium heat exchanger temperature

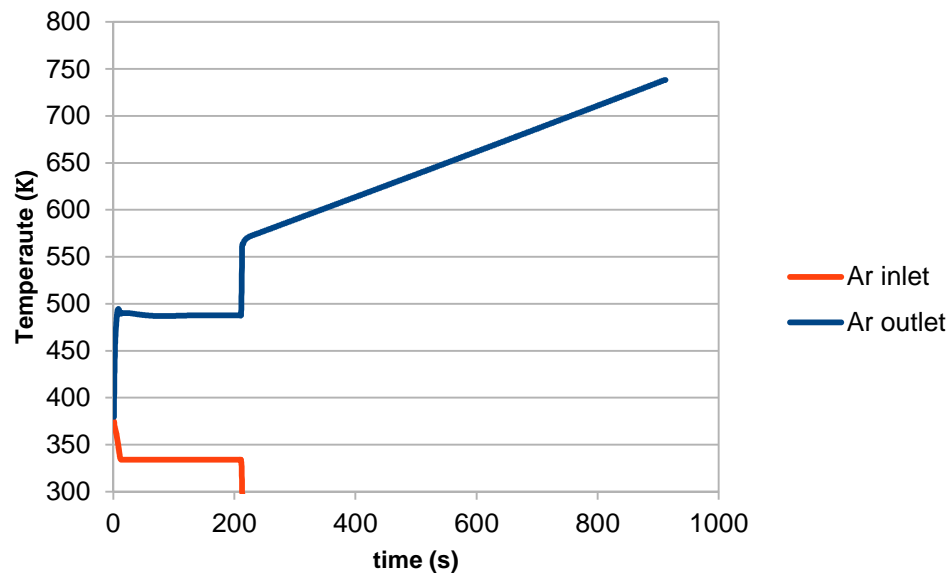

Air-sodium heat exchanger ΔT

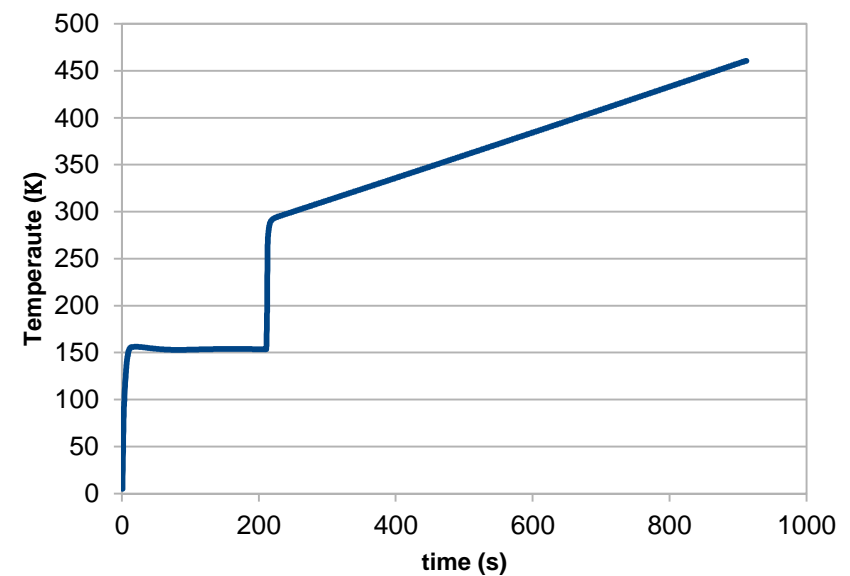

Simulation results: S3 (ULOHS)

- Heat fluxes in heat exchanger
- Flux decreases sharply to 0 on secondary side
- HX absorbs 67 kW due to its thermal inertia

Air-Sodium cooler heat-flux

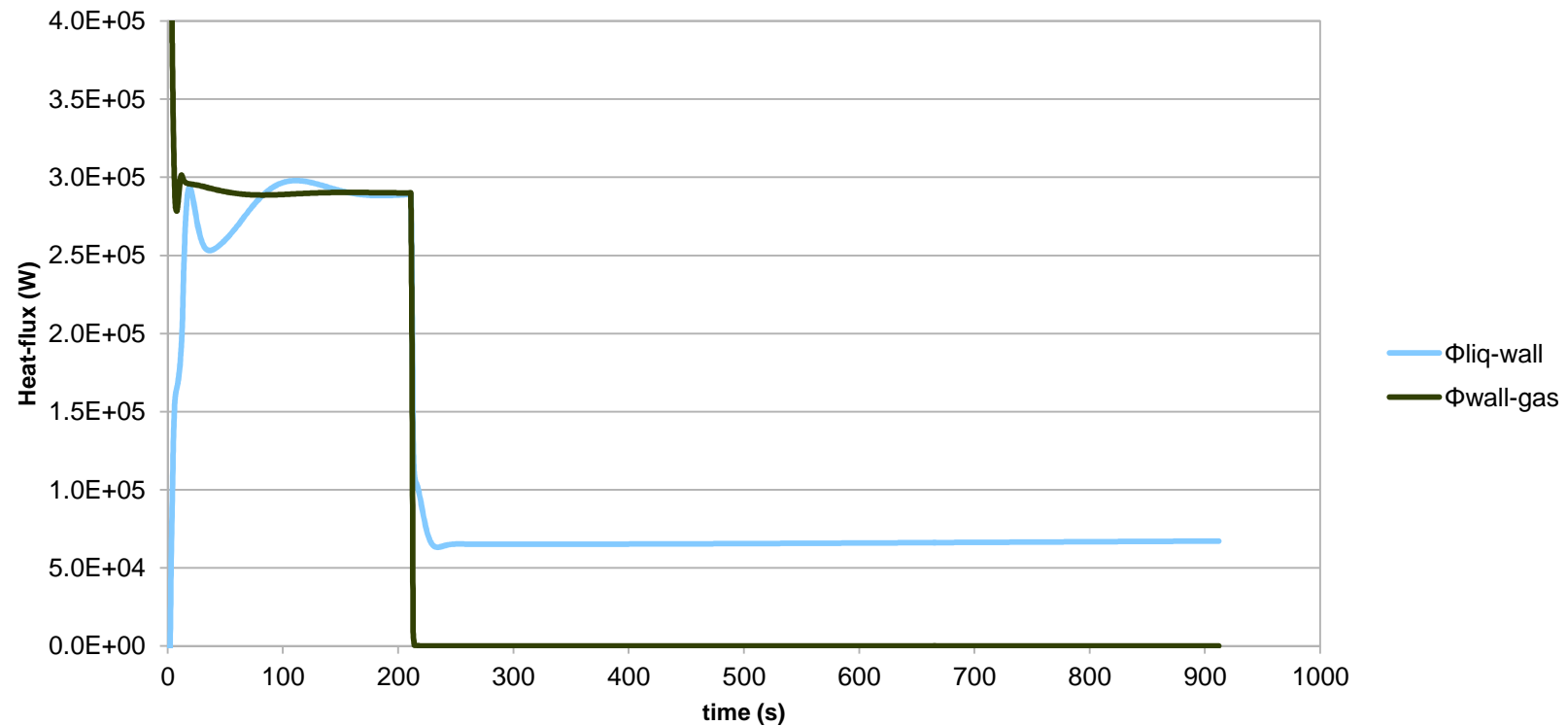

Simulation results: S4 (Constant temperature)

- The heat removal capacity at initial conditions is only 290 kW
- Heater power stabilized at 292.1 kW

