

**KERNFORSCHUNGSZENTRUM
KARLSRUHE**

Juli 1967

KFK 618
EUR 2403 e

Institut für Angewandte Reaktorphysik

Reactor Temperature Transients with Spatial Variables
Second Part: Axial Analysis

L. Caldarola, W. Niedermeyr, J. Woit

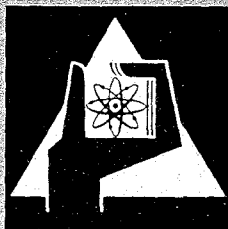

GESELLSCHAFT FÜR KERNFORSCHUNG M. B. H.

KARLSRUHE

KERNFORSCHUNGSZENTRUM KARLSRUHE

July 1967

K F K 618

EUR 2403 e

Institute for Applied Reactor Physics

Reactor Temperature Transients with Spatial Variables *

Second Part: Axial Analysis

by

L. Caldarola **

W. Niedermeyr

J. Voit

Gesellschaft für Kernforschung m.b.H., Karlsruhe

* Work performed within the association in the field of fast reactors between the European Atomic Energy Community and Gesellschaft für Kernforschung m.b.H., Karlsruhe.

** Euratom, Brussels, delegated to the Karlsruhe Fast Breeder Project, Institut für Angewandte Reaktorphysik.

1900

1901

1902

1903

1904

1905

Abstract

Coolant temperature transients are analyzed by solving the spatial-time dependent coolant heat balance equation in a reactor channel.

Results coming from the analysis of the heat propagation in a fuel element are used in this work (see "Reactor Temperature Transients with Spatial Variables - First Part: Radial Analysis" KFK-223).

The solution of the equation is obtained by using the Laplace transform method.

It has been found out that the coolant transients depend upon the following 5 parameters

$$t_r = \text{radial time scale} = \frac{\text{fuel density} \times \text{fuel specific heat capacity}}{\text{fuel thermal conductivity}} \times (\text{fuel radius})^2$$

$$\gamma = \frac{\text{fuel thermal conductivity}}{2 \times \text{fuel coolant heat transfer coefficient} \times \text{fuel radius}}$$

$$\ell = \frac{\text{axial time scale}}{\text{radial time scale}} = \frac{\text{fuel rod length/coolant speed}}{t_r}$$

$$m = \frac{\text{fuel thermal capacity}}{\text{thermal capacity of the associated coolant}}$$

$$\alpha = \pi \frac{\text{fuel rod length}}{\text{extrapolated length}}$$

Numerical examples are also included.

Contents

1. Introduction
 2. Mathematical Fundamentals
 3. The case of constant coolant speed ($\Delta v=0$)
 4. The case of a step change of the coolant speed
 5. Physical meaning of the parameters "l" and "m"
and comparison with the axial lumped model
 6. The case of uniform power distribution along channel
axis
 7. The case of sinusoidal power distribution along
channel axis
 8. Antitransformation to the time domain
 9. Numerical Examples
- Appendix 1
- Appendix 2
- Appendix 3
- Appendix 4
- Appendix 5
- Appendix 6
- Appendix 7
- Appendix 8
- Appendix 9
- Appendix 10
- Appendix 11
- Appendix 12
- Appendix 13
- Appendix 14
- Bibliography

1. Introduction

In nuclear reactors the temperature transients are normally treated by using the well known "lumped model". This model does not take into account any effect due to the heat propagation inside the fuel element and the heat transport along the reactor channel. The heat propagation inside a fuel element (Radial Analysis) was developed in bibl.1.

In this second part (Axial Analysis) the results coming from the first part (Radial Analysis) are incorporated in the heat balance equation of the coolant. Then the complete solution, including the heat transport along the channel, is analyzed.

2. Mathematical Fundamentals

Fig. 1 shows a reactor channel with a cylindrical fuel element and its associated coolant. In each cross section of the fuel element the heat is produced uniformly.

The heat balance equation of the coolant is the following:

$$2\pi Rh(T_s - \theta) = Spc \left(\frac{\partial \theta}{\partial t} + v \frac{\partial \theta}{\partial z} \right) \quad (1)$$

where

- R = external radius of the fuel
- h = heat transfer coefficient between cylinder surface and coolant (supposed to be constant)
- T_s = surface temperature of the cylinder = $T_s(z;t)$
- θ = coolant temperature = $\theta(z;t)$
- S = area of the channel cross-section occupied by coolant
- ρ_c = coolant mass density (supposed to be constant)
- c_c = coolant specific heat capacity (supposed to be constant)
- t = time
- z = axial coordinate (z = 0 at channel middle plane)
- v = coolant speed

In eq. 1 it has been supposed that the coolant temperature " θ " at each cross

section of the reactor channel does not change from point to point of the same cross section. " θ " is therefore a function only of the axial coordinate " z " and of the time " t " and not of the radial coordinate " r ".

In eq. 1 the term related to heat conduction in the coolant along the axial direction has been neglected.

The boundary conditions associated to eq. 1 are the following:

$$[\theta]_{z=-H/2} = \theta_i(t) = \text{given function of the time} \quad (2)$$

$$\left(\frac{\partial T}{\partial r}\right)_{r=R} = -\frac{h}{\lambda} (T_s - \theta) \quad (\text{see Bibl. 1, page 2, eq. 3}) \quad (3)$$

where

θ_i = inlet coolant temperature

H = length of the fuel rod

T = temperature at any point of the fuel

r = radius i. e. radial coordinate .

λ = thermal conductivity of the fuel

Eq. 1 can be written as follows:

$$\frac{1}{\ell} \frac{\partial \theta}{\partial x} + \frac{\partial \theta}{\partial \tau} = \frac{m}{\gamma} (T_s - \theta) \quad (4)$$

where

$$x = \frac{z}{H} = \frac{\text{axial coordinate}}{\text{height of the cylinder}} \quad (5)$$

$$\ell = \frac{H/v}{t_r} = \frac{\text{axial time scale}}{\text{radial time scale}} \quad (6)$$

$$m = \frac{C_f}{C_c} = \frac{\pi R^2 c_f \rho_f H}{c_c S \rho_c H} = \frac{\text{fuel thermal capacity}}{\text{thermal capacity of the associated coolant}} = \text{const.} \quad (7)$$

$$\tau = \frac{t}{t_r} \quad (8)$$

$$t_r = \frac{\rho_f c_f}{\lambda} R^2 = \text{radial time scale} = \text{const.} \quad (9)$$

$$\gamma = \frac{\lambda}{2hR} = \text{const.} \quad (10)$$

Considering the variation of the system from the stationary conditions, we can introduce the following symbols:

$$\Delta T = T - T_o \quad (11)$$

$$\Delta \theta = \theta - \theta_o \quad (12)$$

$$\Delta T_s = T_s - T_{so} \quad (13)$$

$$\Delta v = v - v_o \quad (14)$$

where subscript "o" indicates initial steady state conditions and "Δ" variation from steady state conditions.

From eqs. 6 and 14, we have:

$$\frac{\Delta v}{v_o} = \frac{\lambda_o}{\lambda} - 1 \quad (15)$$

Eq. (4) becomes:

$$\frac{\partial \Delta \theta}{\partial x} + \frac{\Delta v}{v_o} \frac{d\theta_o}{dx} + \frac{\Delta v}{v_o} \frac{\partial \Delta \theta}{\partial x} + \lambda_o \frac{\partial \Delta \theta}{\partial \tau} = \frac{m\lambda_o}{\gamma} (\Delta T_s - \Delta \theta) \quad (16)$$

3. The case of constant coolant speed ($\Delta v = 0$)

The Laplace transform of eq. (16) of para. 2 in the case of constant coolant flow ($\Delta v = 0$ and therefore $\lambda_o = \lambda = \text{const}$) is the following

$$\frac{d\Delta \theta^*}{dx} + \lambda \sigma \Delta \theta^* = \frac{m\lambda}{\gamma} (\Delta T_s^* - \Delta \theta^*) \quad (1)$$

where

"*" indicates Laplace transform

σ = complex variable of the Laplace transformation

The boundary conditions (2) and (3) of para. 2 become respectively:

$$[\Delta \theta^*(\sigma; x)]_{x=1/2} = \Delta \theta_i^*(\sigma) \quad (2)$$

and

$$\left[\frac{d\Delta T^*}{dy} \right]_{y=1} = -\frac{1}{2\gamma} (\Delta T_s^* - \Delta \theta^*) \quad (3)$$

where

$$y = \frac{r}{R} \quad (4)$$

According to Bibl. 1 para. 2 eq. 20, the boundary condition (3) can be substituted by the following equation

$$\Delta T_s^* = G_s(\sigma) \Delta \theta^* + \frac{R}{2h} F_s(\sigma) \frac{\Delta P^*}{V_f} M(x) \quad (5)$$

where

- P = reactor power
- n = number of fuel rods
- V_f = total volume of fuel in the reactor = $n\pi R^2 H$ (6)
- M(x) = normalized power distribution along channel axis

$$\left[\int_{-1/2}^{+1/2} M(x) dx = 1 \right]$$

$$F_s(\sigma) = \frac{1}{\gamma\sigma} [1 - G_s(\sigma)] = \frac{1/\sigma Z(\sigma)}{1 + \gamma/Z(\sigma)} \quad (7)$$

$$G_s(\sigma) = \frac{1}{1 + \frac{\gamma}{Z(\sigma)}} \quad (8)$$

$$Z(\sigma) = - \frac{J_0(\sqrt{-\sigma})}{2\sqrt{-\sigma} J_1(\sqrt{-\sigma})} \quad (9)$$

J_0 and J_1 being Bessel functions of the first kind.

Putting (5) in (1) and taking into account eq. 7, we have:

$$\frac{d\Delta\theta^*}{dx} + \sigma l [1 + mF_s(\sigma)] \Delta\theta^* = \frac{m l}{\gamma} \frac{R}{2h} \frac{1}{V_f} M(x) F_s(\sigma) \Delta P^* \quad (10)$$

Taking into account eqs. (6), (7) and (10) of para. 2, eq. (10) can be written as follows

$$\frac{d\Delta\theta^*}{dx} + \sigma l [1 + mF_s(\sigma)] \Delta\theta^* = \frac{1}{nS\rho_c c_c v} M(x) F_s(\sigma) \Delta P^* \quad (11)$$

At steady state conditions we have

$$P_o = nS\rho_c c_c v (\theta_{out} - \theta_i)_o \quad (12)$$

where

subscript "o" indicates initial steady state conditions

θ_{out} = coolant outlet temperature

θ_i = coolant inlet temperature

We introduce the new function "Y(σ)" so defined

$$Y(\sigma) = \sigma l [1 + mF_s(\sigma)] \quad (13)$$

Taking into account eqs. (12) and (13), eq. (11) can be finally written:

$$\frac{d\Delta\theta^*}{dx} + Y(\sigma)\Delta\theta^* = (\theta_{out} - \theta_i)_o M(x)F_s(\sigma) \frac{\Delta P^*}{P_o} \quad (14)$$

The solution of eq. (14) with associated boundary condition (2) is the following:

$$\Delta\theta^*(\sigma; x) = W(\sigma; x)\Delta\theta_i^*(\sigma) + V(\sigma; x) \cdot [\theta(x) - \theta_i]_o \frac{\Delta P^*(\sigma)}{P_o} \quad (15)$$

where

$$W(\sigma; x) = e^{-(x+1/2)Y(\sigma)} \quad (16)$$

$$[\theta(x) - \theta_i]_o = (\theta_{out} - \theta_i)_o \int_{-1/2}^x M(x') dx' \quad (17)$$

$$V(\sigma; x) = F_s(\sigma) \frac{\int_{-1/2}^x e^{(x'+1/2)Y(\sigma)} M(x') dx'}{e^{(x+1/2)Y(\sigma)} \int_{-1/2}^x M(x') dx'} \quad (18)$$

For practical purposes it is useful to calculate the average temperature $\overline{\Delta\theta^*}(\sigma)$ and the effective temperature $\Delta\theta_{eff}^*(\sigma)$ defined respectively by:

$$\overline{\Delta\theta^*}(\sigma) = \int_{-1/2}^{+1/2} \Delta\theta^*(\sigma; x) dx \quad (19)$$

and

$$\Delta\theta_{eff}^*(\sigma) = \frac{\int_{-1/2}^{+1/2} \Delta\theta^*(\sigma; x) M^2(x) dx}{\int_{-1/2}^{+1/2} M^2(x) dx} \quad (20)$$

Putting (15) in (19), we get:

$$\Delta \bar{\theta}^*(\sigma) = \bar{W}(\sigma) \Delta \theta_i^*(\sigma) + \bar{V}(\sigma) (\bar{\theta} - \theta_i)_o \frac{\Delta P^*(\sigma)}{P_o} \quad (21)$$

where

$$\bar{W}(\sigma) = \int_{-1/2}^{+1/2} W(\sigma; x) dx = \frac{1 - e^{-Y(\sigma)}}{Y(\sigma)} \quad (22)$$

$$(\bar{\theta} - \theta_i)_o = \int_{-1/2}^{+1/2} [\theta(x) - \theta_i]_o dx = (\theta_{out} - \theta_i)_o \int_{-1/2}^{+1/2} \left[\int_{-1/2}^x M(x') dx' \right] dx \quad (23)$$

$$\bar{V}(\sigma) = \frac{\int_{-1/2}^{+1/2} V(\sigma; x) \left[\int_{-1/2}^x M(x') dx' \right] dx}{\int_{-1/2}^{+1/2} \left[\int_{-1/2}^x M(x') dx' \right] dx} \quad (24)$$

Putting (15) in (20) we get:

$$\Delta \theta_{eff}^*(\sigma) = W_{eff}(\sigma) \Delta \theta_i^*(\sigma) + V_{eff}(\sigma) (\theta_{eff} - \theta_i)_o \frac{\Delta P^*(\sigma)}{P_o} \quad (25)$$

where

$$W_{eff}(\sigma) = \frac{\int_{-1/2}^{+1/2} W(\sigma; x) M^2(x) dx}{\int_{-1/2}^{+1/2} M^2(x) dx} \quad (26)$$

$$(\theta_{eff} - \theta_i)_o = \frac{\int_{-1/2}^{+1/2} [\theta(x) - \theta_i]_o M^2(x) dx}{\int_{-1/2}^{+1/2} M^2(x) dx} \quad (27)$$

$$= (\theta_{out} - \theta_i)_o \frac{\int_{-1/2}^{+1/2} M^2(x) \left[\int_{-1/2}^x M(x') dx' \right] dx}{\int_{-1/2}^{+1/2} M^2(x) dx}$$

$$V_{\text{eff}}(\sigma) = \frac{\int_{-1/2}^{+1/2} V(\sigma; x) M^2(x) \left[\int_{-1/2}^x M(x') dx' \right] dx}{\int_{-1/2}^{+1/2} M^2(x) \left[\int_{-1/2}^x M(x') dx' \right] dx} \quad (28)$$

We have for $\sigma = 0$

$$W(0; x) = V(0; x) = \bar{W}(0) = \bar{V}(0) = W_{\text{eff}}(0) = V_{\text{eff}}(0) = 1 \quad (29)$$

The functions $W(\sigma; x)$ and $\bar{W}(\sigma)$ are independent from the power distribution $M(x)$ along the channel axis.

The functions $V(\sigma; x)$; $\bar{V}(\sigma)$; $W_{\text{eff}}(\sigma)$; $V_{\text{eff}}(\sigma)$ are instead dependent on the power distribution $M(x)$ along the channel axis.

4. The case of a step change of the coolant speed

Let us now consider the case of a step change in the coolant speed.

The final coolant speed "v" is given by the following equation

$$v = v_0 + \Delta v = v_0 + \Delta v_c \cdot 1(t) \quad (1)$$

where

v_0 = initial steady state value of the coolant speed

Δv_c = amount of coolant speed change

$1(t)$ = unit step function.

Taking into account eq. 1 and eq. 15 of para. 2, eq. 16 of para. 2 becomes:

$$\frac{\Delta v_c \cdot 1(t)}{v_0} \frac{d\theta_0}{dx} + \left[1 + \frac{\Delta v_c \cdot 1(t)}{v_0} \right] \frac{\partial \Delta \theta}{\partial x} + \ell_0 \frac{\partial \Delta \theta}{\partial \tau} = \frac{m \ell_0}{\gamma} (\Delta T_s - \Delta \theta) \quad (2)$$

The Laplace transform of eq. 2 is the following

$$\frac{1}{\sigma} \frac{\Delta v_c}{v_0} \frac{d\theta_0}{dx} + \left(1 + \frac{\Delta v_c}{v_0} \right) \frac{d\Delta \theta^*}{dx} + \ell_0 \sigma \Delta \theta^* = \frac{m \ell_0}{\gamma} (\Delta T_s^* - \Delta \theta^*) \quad (3)$$

We divide all the terms of eq. 3 by the factor

$$1 + \frac{\Delta v_c}{v_o} = \frac{v}{v_o} = \frac{l_o}{l} \quad (4)$$

and we get:

$$\frac{d\Delta\theta^*}{dx} + \lambda\sigma\Delta\theta^* = \frac{m\lambda}{\gamma} (\Delta T_s^* - \Delta\theta^*) - \frac{l}{l_o} \frac{d\theta_o}{dx} \frac{\Delta v_c}{v_o} \frac{1}{\sigma} \quad (5)$$

We have from eq. 17 of para. 3

$$\frac{d\theta_o}{dx} = (\theta_{out} - \theta_i)_o M(x) \quad (6)$$

Eq. 5 of para. 3 is:

$$\Delta T_s^* = G_s(\sigma)\Delta\theta^* + \frac{R}{2h} F_s(\sigma) \frac{\Delta P^*}{v_f} M(x) \quad (7)$$

Putting eqs. (6) and (7) in (5) and taking into account eq.(7) of para. 3, we get

$$\frac{d\Delta\theta^*}{dx} + Y(\sigma)\Delta\theta^* = -\frac{l}{l_o} (\theta_{out} - \theta_i)_o M(x) \frac{\Delta v_c}{v_o} \frac{1}{\sigma} + \frac{l}{l_o} (\theta_{out} - \theta_i)_o M(x) F_s(\sigma) \frac{\Delta P^*}{P_o} \quad (8)$$

where

$$Y(\sigma) = \lambda\sigma [1 + m F_s(\sigma)] \quad (9)$$

The solution of eq. (8) is the following

$$\Delta\theta^*(\sigma; x) = -\bar{W}(\sigma; x) [\theta(x) - \theta_i]_o \frac{l}{l_o} \frac{\Delta v_c}{v_o} \frac{1}{\sigma} + \Delta\theta_i^*(\sigma) W(\sigma; x) + \frac{l}{l_o} \frac{\Delta P^*(\sigma)}{P_o} V(\sigma; x) [\theta(x) - \theta_i]_o \quad (10)$$

where

$$\bar{W}(\sigma; x) = \frac{\int_{-1/2}^x e^{(x'+1/2)Y(\sigma)} M(x') dx'}{e^{(x+1/2)Y(\sigma)} \int_{-1/2}^x M(x') dx'} \quad (11)$$

$$[\theta(x) - \theta_i]_o = (\theta_{out} - \theta_i)_o \int_{-1/2}^x M(x') dx' \quad (12)$$

and $W(\sigma; x)$ and $V(\sigma; x)$ are defined in para. 3.

For the average coolant temperature $\bar{\theta}$ and for the effective coolant temperature θ_{eff} , we have

$$\begin{aligned} \Delta\bar{\theta}^* = & -\bar{W}(\sigma) \frac{\ell}{\ell_0} [\bar{\theta} - \theta_{i_0}] \frac{\Delta v_c}{v_0} \frac{1}{\sigma} + \\ & + \Delta\theta_{i_0}^*(\sigma) \bar{W}(\sigma) + \frac{\ell}{\ell_0} \frac{\Delta P^*(\sigma)}{P_0} \bar{V}(\sigma) [\bar{\theta} - \theta_{i_0}] \end{aligned} \quad (13)$$

and

$$\begin{aligned} \Delta\theta_{\text{eff}}^* = & -\frac{\ell}{\ell_0} \bar{W}_{\text{eff}}(\sigma) [\theta_{\text{eff}} - \theta_{i_0}] \frac{\Delta v_c}{v_0} \frac{1}{\sigma} + \\ & + \Delta\theta_{i_0}^*(\sigma) W_{\text{eff}}(\sigma) + \frac{\ell}{\ell_0} \frac{\Delta P^*(\sigma)}{P_0} V_{\text{eff}}(\sigma) [\theta_{\text{eff}} - \theta_{i_0}] \end{aligned} \quad (14)$$

where

$$\bar{W}(\sigma) = \frac{\int_{-1/2}^{+1/2} \bar{W}(\sigma; x) \left[\int_{-1/2}^x M(x') dx' \right] dx}{\int_{-1/2}^{+1/2} \left[\int_{-1/2}^x M(x') dx' \right] dx} \quad (15)$$

$$(\bar{\theta} - \theta_{i_0})_0 = (\theta_{\text{out}} - \theta_{i_0})_0 \int_{-1/2}^{+1/2} \left[\int_{-1/2}^x M(x') dx' \right] dx \quad (16)$$

$$\bar{W}_{\text{eff}}(\sigma) = \frac{\int_{-1/2}^{+1/2} \bar{W}(\sigma; x) M^2(x) \left[\int_{-1/2}^x M(x') dx' \right] dx}{\int_{-1/2}^{+1/2} M^2(x) \left[\int_{-1/2}^x M(x') dx' \right] dx} \quad (17)$$

$$(\theta_{\text{eff}} - \theta_{i_0})_0 = (\theta_{\text{out}} - \theta_{i_0})_0 \frac{\int_{-1/2}^{+1/2} M^2(x) \left[\int_{-1/2}^x M(x') dx' \right] dx}{\int_{-1/2}^{+1/2} M^2(x) dx} \quad (18)$$

and $\bar{W}(\sigma)$; $\bar{V}(\sigma)$; $W_{\text{eff}}(\sigma)$ and $V_{\text{eff}}(\sigma)$ are defined in paragraph 3. The following properties are important.

From eq. (18) of para. 3 and eq. (11), we get

$$V(\sigma; x) = F_s(\sigma) \bar{W}(\sigma; x) \quad (19)$$

From eq. (24) of para. 3 and eq. (15), we can write

$$\bar{V}(\sigma) = F_s(\sigma) \cdot \bar{\bar{W}}(\sigma) \quad (20)$$

From eq. (28) of para. 3 and eq. (17), we obtain

$$V_{\text{eff}}(\sigma) = F_s(\sigma) \bar{\bar{W}}_{\text{eff}}(\sigma) \quad (21)$$

In case of complete loss of coolant eq. (3) becomes

$$\lambda_o \sigma \Delta \theta^* = \frac{m \lambda_o}{\gamma} (\Delta T_s^* - \Delta \theta^*) + \frac{d\theta_o}{dx} \frac{1}{\sigma} \quad (22)$$

In case of constant power ($\Delta P=0$) and constant inlet coolant temperature ($\Delta \theta_i=0$) and taking into account eqs. (6) and (7), eq. (22) becomes

$$\Delta \theta^* = \frac{1}{\lambda_o \sigma^2 [1 + m F_s(\sigma)]} M(x) (\theta_{\text{out}} - \theta_i)_o \quad (23)$$

5. Physical meaning of the parameters "l" and "m" and comparison with the axial lumped model

In addition to the definitions of the parameters "l" and "m" given respectively by eqs. (6) and (7) of para. 2, it is possible to obtain another expression for the product "lm" which has an interesting physical meaning.

Eq.(4) of para. 2 at steady state conditions becomes the following

$$\frac{d\theta}{dx} = \frac{m \lambda}{\gamma} (T_s - \theta) \quad (1)$$

Integrating eq. (1), we get

$$\frac{m \lambda}{\gamma} = \frac{\theta_{\text{out}} - \theta_i}{\bar{T}_s - \bar{\theta}} \quad (2)$$

Eq. 54 of para. 4 in Bibl. 1 gives for γ the following equation at steady state conditions

$$\gamma = \frac{1}{4} \frac{T_s - \bar{\theta}}{T_c - T_s} = \frac{1}{4} \frac{\bar{T}_s - \bar{\theta}}{\bar{T}_c - \bar{T}_s} \quad (3)$$

where

T_c = central fuel temperature

and the line at the top indicates average along the "x" axis.

By combining eqs. (2) and (3), we get

$$m\ell = \frac{1}{4} \frac{\theta_{out} - \theta_i}{\bar{T}_c - \bar{T}_s} \quad (4)$$

If the coolant speed is large, " ℓ " becomes small (eq. (6) of para. 2) and the product $m\ell$ becomes small. We have from eq. (4) that the steady state axial coolant temperature profile becomes small in comparison to the fuel radial temperature profile. This means that a more simplified axial model called "lumped model" can be used.

The lumped model is defined by the following relationship between average, outlet and inlet coolant temperatures.

$$\bar{\Delta\theta} = \frac{\Delta\theta_i + \Delta\theta_{out}}{2} \quad (5)$$

Integrating eq. (14) of para. 3 and eq. (8) of para. 4 in respect to "x", we get respectively

$$\Delta\theta_{out}^* - \Delta\theta_i^* + Y(\sigma)\bar{\Delta\theta}^* = (\theta_{out} - \theta_i)_o F_s(\sigma) \frac{\Delta P^*}{P_o} \quad (6)$$

and

$$\Delta\theta_{out}^* + Y(\sigma)\bar{\Delta\theta}^* = (\theta_{out} - \theta_i)_o \frac{\Delta v_c}{v_o} \frac{1}{\sigma} \quad (7)$$

Taking into account eq. (5), we get respectively from (6) and (7)

$$\bar{\Delta\theta}^* = \frac{1}{1+Y(\sigma)/2} \Delta\theta_i^* + (\bar{\theta} - \theta_i)_o \frac{F_s(\sigma)}{1+Y(\sigma)/2} \frac{\Delta P^*}{P_o} \quad (8)$$

$$\bar{\Delta\theta}^* = \frac{1}{1+Y(\sigma)/2} (\bar{\theta} - \theta_i)_o \frac{\Delta v_c}{v_o} \frac{1}{\sigma} \quad (9)$$

If we compare eq. (8) and (9) respectively with eq. (21) of para. 3 and (10) of para. 4, we realize that we obtain the same result by calculating the following limits

$$\begin{aligned} \lim_{\ell \rightarrow 0} \bar{W}(\sigma) &= \lim_{Y(\sigma) \rightarrow 0} \frac{1 - e^{-Y(\sigma)}}{Y(\sigma)} = \lim_{Y(\sigma) \rightarrow 0} \frac{e^{Y(\sigma)/2} - e^{-Y(\sigma)/2}}{Y(\sigma) e^{Y(\sigma)/2}} = \\ &= \lim_{Y(\sigma) \rightarrow 0} \frac{1}{1 + Y(\sigma)/2} \end{aligned} \quad (10)$$

and

$$\lim_{\ell \rightarrow 0} \bar{V}(\sigma) = \lim_{Y(\sigma) \rightarrow 0} \bar{V}(\sigma) = \lim_{Y(\sigma) \rightarrow 0} \frac{F_s(\sigma)}{1 + Y(\sigma)/2} \quad (11)$$

6. The case of uniform power distribution along channel axis

In this case we have

$$M(x) = 1 \quad (1)$$

Eqs. (17) and (18) of para. 3 give respectively

$$[\theta(x) - \theta_i]_0 = (x+1/2) [\theta_{out} - \theta_i]_0 \quad (2)$$

$$V(\sigma; x) = \frac{1}{x+1/2} \frac{F_s(\sigma)}{Y(\sigma)} \left[1 - e^{-(x+1/2)Y(\sigma)} \right] \quad (3)$$

Eq. (26) of para. 3 gives

$$W_{eff}(\sigma) = \bar{W}(\sigma) = \frac{1 - e^{-Y(\sigma)}}{Y(\sigma)} \quad (4)$$

Eqs. (23) and (27) of para. 3 give:

$$(\bar{\theta} - \theta_i)_0 = (\theta_{eff} - \theta_i)_0 = \frac{1}{2} (\theta_{out} - \theta_i)_0 \quad (5)$$

Eqs. (24) and (28) of para. 3 give:

$$\bar{V}(\sigma) = V_{eff}(\sigma) = 2 \frac{F_s(\sigma)}{Y(\sigma)} \left[1 - \frac{1 - e^{-Y(\sigma)}}{Y(\sigma)} \right] \quad (6)$$

Eq. (13) of para. 4 gives:

$$\bar{W}(\sigma; x) = \frac{1 - e^{-(x+1/2)Y(\sigma)}}{(x+1/2) Y(\sigma)} \quad (7)$$

Eqs. (17) and (19) of para. 4 give:

$$\bar{W}(\sigma) = \bar{W}_{\text{eff}}(\sigma) = 2 \left[1 - \frac{1 - e^{-Y(\sigma)}}{Y(\sigma)} \right] \quad (8)$$

In the next sections of this paragraph the functions $W(\sigma; x)$; $V(\sigma; x)$; $\bar{W}(\sigma)$ and $\bar{V}(\sigma)$ are developed in expressions which are easily antitransformable to the time domain.

6.1 Expansion in series of poles of the function $W(\sigma; x)$

The function

$$W(\sigma; x) = e^{-(x+1/2)Y(\sigma)} \quad (1)$$

can be developed on the imaginary axis ($\sigma = j\omega$) as follows (see Appendix 1):

$$W(\sigma; x) \approx e^{-\ell(x+1/2)\sigma} \left[w_1 + (1-w_1) \sum_{n=1}^{n=\infty} D_n \frac{1 + E_n \sigma}{1 + A_n \sigma + B_n \sigma^2} \right] \quad (2)$$

where:

$$w_1 = \exp \left[-\frac{m\ell}{\gamma} (x+1/2) \right] \quad (3)$$

$$A_n = \frac{a_n}{(1 - e^{-a_n/2}) \sigma_n} \quad (4)$$

$$B_n = \frac{e^{a_n/2}}{\sigma_n^2} \quad (5)$$

$$a_n = (x+1/2) \frac{m\ell}{0.25 + \gamma^2 \sigma_n} \quad (6)$$

$$D_n = \frac{1 - e^{-a_n}}{1 - e^{-(m\ell/\gamma)(x+1/2)}} \left[R_n + I_n \frac{\mu_n}{\nu_n} \right] \quad (7)$$

$$E_n = \frac{1}{\nu_n} / \left(\frac{R_n}{I_n} + \frac{\mu_n}{\nu_n} \right) \quad (8)$$

σ_n = "n"th root of the Bessel function equation $Z(\sigma)+\gamma=0$ and $Z(\sigma)$ given by eq. (23) of para. 2 in bibl. 1.

R_n and I_n being respectively real and imaginary parts of the expression:

$$\left(1 - \frac{\sigma'_n A_n}{e^{a_n/2} + 1}\right) \prod_{\substack{m=1 \\ m \neq n}}^{m=\infty} \left(\frac{1 - A_m e^{-a_m/2} \sigma'_n + B_m e^{-a_m} (\sigma'_n)^2}{1 - A_m \sigma'_n + B_m (\sigma'_n)^2} \right) \quad (9)$$

where

$$\sigma'_n = \mu_n - j\nu_n \quad (10)$$

with

$$\mu_n = + \frac{A_n}{2B_n} \quad (11)$$

and

$$\nu_n = \sqrt{\frac{1}{B_n} - \left(\frac{A_n}{2B_n}\right)^2} \quad (12)$$

we have

$$\sum_{n=1}^{n=\infty} D_n = 1 \quad (13)$$

6.2 Expansion in series of poles of the function $V(\sigma;x)$ in the case of uniform power distribution

The function

$$V(\sigma;x) = \frac{1}{x+1/2} \frac{F_s(\sigma)}{Y(\sigma)} [1 - e^{-(x+1/2)Y(\sigma)}] \quad (1)$$

can be developed as follows on the imaginary axis ($\sigma=j\nu$)

(See Appendix 3)

$$V(\sigma;x) = v_1 \frac{1 - e^{-(x+1/2)j\nu}}{(x+1/2)j\nu} + v_2 \sum_{n=1}^{n=\infty} \frac{P_n}{1 + \sigma/\sigma_n^*} + \quad (2)$$

$$+ v_3 e^{-(x+1/2)j\nu} \sum_{n=1}^{n=\infty} \frac{P'_n}{1 + \sigma/\sigma_n^*} + v_4 e^{-(x+1/2)j\nu} \sum_{n=1}^{n=\infty} M_n \frac{1 + N_n \sigma}{1 + A_n \sigma + B_n \sigma^2}$$

where

$$v_1 = \frac{1}{1+m} \quad (3)$$

$$v_2 = - \frac{\gamma+1/8}{\ell(1+m)^2} \frac{1}{x+1/2} \quad (4)$$

$$v_3 = \frac{\gamma+1/8}{\ell(1+m)^2} \frac{1}{x+1/2} + \frac{m}{1+m} (1-S_1) \quad (5)$$

$$v_4 = \frac{m}{1+m} S_1$$

$$P_n = \frac{4}{\gamma+1/8} \frac{(1+m)^2}{\sigma_n^* \left[(4m+\sigma_n^*) + 4(\gamma\sigma_n^*-m)^2 \right]} \quad (6)$$

$$P_n' = \sigma_n^* P_n \frac{(\gamma+1/8)}{\ell(1+m)^2(x+1/2)} \frac{\frac{1}{\sigma_n^*} + (1-w_1) \sum_{k=1}^{k=\infty} D_k (A_k - E_k) \frac{1 - \frac{B_k}{A_k - E_k} \sigma_n^*}{1 - A_k \sigma_n^* + B_k (\sigma_n^*)^2}}{\frac{1}{(x+1/2)} \frac{\gamma+1/8}{\ell(1+m)^2} + \frac{m}{1+m} (1-S_1)} \quad (7)$$

$$N_n = \frac{1}{U_n} \left/ \left(\frac{\mu_n}{U_n} + \frac{R_n^V}{I_n^V} \right) \right. \quad (8)$$

$$M_n = \frac{1}{S_1} \left(\frac{\mu_n}{U_n} I_n^V + R_n^V \right) \quad (9)$$

$$S_1 = \sum_{n=1}^{n=\infty} \left(\frac{\mu_n}{U_n} I_n^V + R_n^V \right) \quad (10)$$

R_n^V and I_n^V being respectively real and imaginary parts of the function:

$$\frac{1-w_1}{m\ell(x+1/2)} \frac{F_s(-\sigma_n')}{1+mF(-\sigma_n')} D_n (A_n - E_n) \left(1 - \frac{B_n}{A_n - E_n} \sigma_n' \right) \quad (11)$$

and

$$\sigma_n' = \mu_n - j\nu_n \quad (12)$$

$$1-S_1 = \frac{1-w_1}{m\ell(x+1/2)} \frac{\gamma+1/8}{1+m} \sum_{n=1}^{n=\infty} P_n \sigma_n^* \left[\sum_{k=1}^{k=\infty} D_k (A_k - E_k) \frac{1 - \frac{B_k}{A_k - E_k} \sigma_n^*}{1 - A_k \sigma_n^* + B_k (\sigma_n^*)^2} \right] \quad (13)$$

σ_n^* is the "n"th zero of the Bessel function equation

$$Z(\sigma) + \gamma + \frac{m}{\sigma} = 0 \quad (14)$$

$\mu_n; \nu_n; A_n; B_n; D_n$ and E_n are given in para. 6.1

$\gamma; \ell; m$ and $Z(\sigma)$ are given in para. 2 and 3.

We have:

$$v_1 + v_2 + v_3 + v_4 = 1 \quad (15)$$

$$\sum_{n=1}^{n=\infty} P_n = \sum_{n=1}^{n=\infty} P'_n = \sum_{n=1}^{n=\infty} M_n = 1 \quad (16)$$

$$-\ell\gamma v_2(x+1/2) \cdot \sum_{n=1}^{n=\infty} P_n (\sigma_n^*)^2 = 1 \quad (17)$$

6.3 Expansion in series of poles of the function $\bar{W}(\sigma)$

The function

$$\bar{W}(\sigma) = \frac{1-e^{-Y(\sigma)}}{Y(\sigma)} \quad (1)$$

can be developed on the imaginary axis as follows (see Appendix 6):

$$\begin{aligned} \bar{W}(\sigma) = & \bar{w}_1 \frac{1-e^{-\ell\sigma}}{\ell\sigma} + \bar{w}_2 \sum_{n=1}^{n=\infty} \frac{\bar{L}_n}{1+\sigma/\sigma_n^*} + \bar{w}_3 e^{-\ell\sigma} \sum_{n=1}^{n=\infty} \frac{\bar{L}'_n}{1+\sigma/\sigma_n^*} + \\ & + \bar{w}_4 e^{-\ell\sigma} \sum_{n=1}^{n=\infty} \bar{C}_n \frac{1+\bar{G}_n \sigma}{1+\bar{A}_n \sigma + \bar{B}_n \sigma^2} \end{aligned} \quad (2)$$

where

$$\bar{w}_1 = \frac{1}{1+m} \quad (3)$$

$$\bar{w}_2 = m \frac{\gamma+1/8}{\ell(1+m)^2} \quad (4)$$

$$\bar{w}_3 = -m \frac{\gamma+1/8}{\lambda(1+m)^2} - \frac{m^2}{1+m} (1-\bar{S}_1) \quad (5)$$

$$\bar{w}_4 = m - \frac{m^2}{1+m} \bar{S}_1 \quad (6)$$

$$\bar{L}_n = \frac{4(1+m)^2}{\sigma_n^* (\gamma+1/8) [(4m+\sigma_n^*)+4(\gamma\sigma_n^*-m)^2]} = P_n \quad (7)$$

$$\bar{L}'_n = (P'_n)_{x=1/2} \quad (8)$$

$$\bar{C}_n = \frac{\frac{1-e^{-m\lambda/\gamma}}{\lambda} \bar{D}_n (\bar{A}_n - \bar{E}_n) - \frac{m^2}{1+m} \bar{S}_1 \bar{M}_n}{m - \frac{m^2}{1+m} \bar{S}_1} \quad (9)$$

$$\bar{G}_n = \frac{\frac{1-e^{-m\lambda/\gamma}}{\lambda} \bar{D}_n \bar{B}_n - \frac{m^2}{1+m} \bar{S}_1 \bar{M}_n \bar{N}_n}{\bar{C}_n \left[m - \frac{m^2}{1+m} \bar{S}_1 \right]} \quad (10)$$

\bar{S}_1 ; \bar{A}_n ; \bar{B}_n ; \bar{D}_n ; \bar{E}_n ; \bar{M}_n and \bar{N}_n being S_1 ; A_n ; B_n ; D_n ; E_n ; M_n and N_n calculated for $x = 1/2$.

σ_n^* , P'_n , S_1 , M_n , N_n are given in para. 6.2

A_n , B_n , D_n and E_n are given in para. 6.1

m , λ , and γ are given in para. 2 and 3

We have

$$\bar{w}_1 + \bar{w}_2 + \bar{w}_3 + \bar{w}_4 = 1 \quad (11)$$

$$\sum_{n=1}^{n=\infty} \bar{L}_n = \sum_{n=1}^{n=\infty} \bar{L}'_n = \sum_{n=1}^{n=\infty} \bar{C}_n = 1 \quad (12)$$

6.4 Expansion in series of poles of the function $\bar{V}(\sigma)$ in the case of uniform power distribution

The function

$$\bar{V}(\sigma) = 2 \frac{F_s(\sigma)}{Y(\sigma)} \left[1 - \frac{1-e^{-Y(\sigma)}}{Y(\sigma)} \right] \quad (1)$$

can be developed on the imaginary axis ($\sigma=j\omega$) as follows (see Appendix 7):

$$\begin{aligned} \bar{V}(\sigma) = & \bar{v}_1 \frac{1-e^{-\ell\sigma}}{\ell\sigma} - \bar{v}_2 \frac{1-e^{-\ell\sigma}}{\frac{1}{2}\ell^2\sigma^2} + \bar{v}_2 \frac{2}{\ell\sigma} + \bar{v}_3 \sum_{n=1}^{n=\infty} \frac{\bar{P}_n}{1+\sigma/\sigma_n^*} + \\ & + \bar{v}_4 e^{-\ell\sigma} \sum_{n=1}^{n=\infty} \frac{\bar{P}'_n}{1+\sigma/\sigma_n^*} + \bar{v}_5 \sum_{n=1}^{n=\infty} \frac{\bar{Q}_n}{(1+\sigma/\sigma_n^*)^2} + \bar{v}_6 e^{-\ell\sigma} \sum_{n=1}^{n=\infty} \frac{\bar{Q}'_n}{(1+\sigma/\sigma_n^*)^2} + \\ & + \bar{v}_7 e^{-\ell\sigma} \sum_{n=1}^{n=\infty} \bar{Z}_n \frac{1+\bar{H}_n\sigma}{1+\bar{A}_n\sigma+\bar{B}_n\sigma^2} \end{aligned} \quad (2)$$

where

$$\bar{v}_1 = \frac{2(\gamma+1/8)}{\ell(1+m)^2} \bar{w}_1 + \frac{2(\bar{w}_3+\bar{w}_4)}{1+m} \quad (3)$$

$$\bar{v}_2 = \frac{\bar{w}_1}{1+m} \quad (4)$$

$$\bar{v}_3 = -\frac{2\bar{w}_1}{\ell(1+m)^2} (\gamma+1/8) - \frac{2\bar{w}_1}{\ell^2(1+m)} \left[\left(\frac{\gamma+1/8}{1+m}\right)^2 + \frac{1}{192(1+m)} \right] + \quad (5)$$

$$+ \frac{2\bar{w}_2}{\ell(1+m)} \frac{\gamma+1/8}{1+m} \sum_{n=1}^{n=\infty} \bar{L}_n \left[\sum_{\substack{k=1 \\ k \neq n}}^{k=\infty} \frac{\sigma_k^*}{\sigma_n^*} \bar{L}_k \frac{1+(\sigma_n^*/\sigma_k^*)^2}{1-\sigma_n^*/\sigma_k^*} \right] -$$

$$- \frac{2(\bar{w}_3+\bar{w}_4)}{\ell(1+m)} \frac{\gamma+1/8}{1+m}$$

$$\bar{v}_4 = + \frac{2\bar{w}_1}{\ell^2(1+m)} \left[\left(\frac{\gamma+1/8}{1+m}\right)^2 + \frac{1}{192(1+m)} \right] + \frac{2(\bar{w}_3+\bar{w}_4)}{\ell(1+m)} \frac{\gamma+1/8}{1+m} + \quad (6)$$

$$+ \frac{2\bar{w}_3'}{\ell(1+m)} \frac{\gamma+1/8}{1+m} \sum_{n=1}^{n=\infty} \sum_{\substack{k=1 \\ k \neq n}}^{k=\infty} \frac{\frac{\sigma_n^*}{\sigma_k^*} \bar{L}_n \bar{L}'_k + \frac{\sigma_k^*}{\sigma_n^*} \bar{L}'_n \bar{L}_k}{1 - \frac{\sigma_n^*}{\sigma_k^*}}$$

$$+ \frac{2\bar{w}_4}{\ell(1+m)} \frac{\gamma+1/8}{1+m} \sum_{n=1}^{n=\infty} \bar{L}_n \sigma_n^* \left[\sum_{k=1}^{k=\infty} \bar{C}_k (\bar{A}_k - \bar{G}_k) \frac{1 - \frac{\bar{B}_k}{\bar{A}_k - \bar{G}_k} \sigma_n^*}{1 - \bar{A}_k \sigma_n^* + \bar{B}_k (\sigma_n^*)^2} \right]$$

$$\bar{v}_5 = \frac{2\bar{w}_2}{\ell(1+m)} \frac{\gamma+1/8}{1+m} \sum_{n=1}^{n=\infty} \bar{L}_n^2 \quad (7)$$

$$\bar{v}_6 = \frac{2\bar{w}_3}{\ell(1+m)} \frac{\gamma+1/8}{(1+m)} \sum_{n=1}^{n=\infty} \bar{L}_n \bar{L}'_n \quad (8)$$

$$\bar{v}_7 = \frac{2\bar{w}'_4}{\ell(1+m)} \sum_{n=1}^{n=\infty} \left(\frac{\bar{u}_n}{\bar{v}_n} I_n^w + R_n^w \right) \quad (9)$$

$$\bar{p}_n = 2 \frac{\bar{L}_n}{\bar{v}_3} \frac{\gamma+1/8}{\ell(1+m)^2} \left[-1 + \frac{m(\gamma+1/8)}{\ell(1+m)^2} - \frac{1}{\ell(1+m)\sigma_n^*} + \frac{m(\gamma+1/8)}{\ell(1+m)^2} \sum_{\substack{k=1 \\ k \neq n}}^{k=\infty} \frac{\sigma_k^*}{\sigma_n^*} \bar{L}_k \frac{1+\sigma_n^*/\sigma_k^*}{1-\sigma_n^*/\sigma_k^*} \right] \quad (10)$$

$$\bar{p}_n = 2 \frac{\bar{L}_n}{\bar{v}_4} \frac{\gamma+1/8}{\ell(1+m)^2} \left\{ \bar{w}_4 \left[1 + \sigma_n^* \sum_{k=1}^{k=\infty} \bar{C}_k (\bar{A}_k - \bar{G}_k) \frac{1 - \frac{\bar{B}_k}{\bar{A}_k - \bar{G}_k} \sigma_n^*}{1 - \bar{A}_k \sigma_n^* + \bar{B}_k (\sigma_n^*)^2} \right] + \right. \quad (11)$$

$$\left. + \bar{w}_3 \left[1 + \sum_{\substack{k=1 \\ k \neq n}}^{k=\infty} \frac{\frac{\sigma_n^*}{\sigma_k^*} \bar{L}'_k + \frac{\sigma_k^*}{\sigma_n^*} \frac{\bar{L}'_n \bar{L}'_k}{\bar{L}_n}}{1 - \sigma_n^*/\sigma_k^*} \right] + \frac{\bar{w}_1}{\ell \sigma_n^*} \right\}$$

$$\bar{q}_n = \frac{\bar{L}_n^2}{\sum_{n=1}^{n=\infty} \bar{L}_n^2} \quad (12)$$

$$\bar{q}'_n = \frac{\bar{L}_n \bar{L}'_n}{\sum_{n=1}^{n=\infty} \bar{L}_n \bar{L}'_n} \quad (13)$$

$$\bar{Z}_n = \frac{\left(\frac{m}{1+m}\right)^2 + \frac{2m(\gamma+1/8)}{\ell(1+m)^3} + \bar{K}}{2\bar{w}_n/\ell(1+m)} \left(\frac{\bar{\mu}_n}{\bar{u}_n} I_n^W + R_n^W \right) \quad (14)$$

$$\bar{H}_n = \frac{1}{\bar{u}_n} \left/ \left(\frac{\bar{\mu}_n}{\bar{u}_n} + \frac{R_n^W}{I_n^W} \right) \right. \quad (15)$$

I_n^W and R_n^W being respectively real and imaginary parts of the function:

$$\frac{\frac{2\bar{w}_4}{\ell(1+m)} (1+m)}{\left(\frac{m}{1+m}\right)^2 + \frac{2m(\gamma+1/8)}{\ell(1+m)^3} + \bar{K}} \frac{F_s(-\bar{\sigma}'_n)}{1+mF_s(-\bar{\sigma}'_n)} \bar{C}_n (\bar{A}_n - \bar{G}_n) \left(1 - \frac{\bar{B}_n}{\bar{A}_n - \bar{G}_n} \bar{\sigma}'_n\right) \quad (16)$$

$$\bar{\sigma}'_n = \bar{\mu}_n - j\bar{u}_n \quad (17)$$

$$\bar{\mu}_n = \frac{\bar{A}_n}{2\bar{B}_n} \quad (18)$$

$$\bar{u}_n = \sqrt{\frac{1}{\bar{B}_n} - \left(\frac{\bar{A}_n}{2\bar{B}_n}\right)^2} \quad (19)$$

$\bar{w}_1; \bar{w}_2; \bar{w}_3; \bar{w}_4; \bar{L}_n; \bar{L}'_n; \bar{C}_n; \bar{G}_n$ are given in para. 6.3

σ_n^* is given in para. 6.2

\bar{A}_n and \bar{B}_n being respectively A_n and B_n at $x = 1/2$

A_n and B_n are given in para. 6.1

$m\ell$ and γ are given in para. 2 and 3

$$\bar{K} = \frac{2(1-w_1)m}{\ell^2(1+m)^2} \frac{\gamma+1/8}{1+m} \sum_{n=1}^{n=\infty} L_n \left[\sum_{k=1}^{k=\infty} \bar{D}_k (\bar{A}_k - \bar{E}_k) \frac{1 - \frac{\bar{B}_k}{\bar{A}_k - \bar{E}_k} \sigma_n^*}{1 - \bar{A}_k \sigma_n^* + \bar{B}_k (\sigma_n^*)^2} \right] \quad (20)$$

We have:

$$\bar{v}_1 + \bar{v}_2 + \bar{v}_3 + \bar{v}_4 + \bar{v}_5 + \bar{v}_6 + \bar{v}_7 = 1 \quad (21)$$

$$\sum_{n=1}^{n=\infty} \bar{p}_n = \sum_{n=1}^{n=\infty} \bar{p}'_n = \sum_{n=1}^{n=\infty} \bar{O}_n = \sum_{n=1}^{n=\infty} \bar{Z}_n = 1 \quad (22)$$

$$\bar{v}_1 + \frac{2\bar{v}_2}{\ell} + \bar{v}_3 \sum_{n=1}^{n=\infty} \bar{P}_n \sigma_n^* = 0 \quad (23)$$

$$\frac{\ell\gamma}{2} \left[\bar{v}_5 \sum_{n=1}^{n=\infty} \bar{Q}_n (\sigma_n^*)^2 - \bar{v}_3 \sum_{n=1}^{n=\infty} \bar{P}_n (\sigma_n^*)^2 - \frac{2\bar{v}_2}{\ell^2} \right] = 1 \quad (24)$$

7. The case of sinusoidal power distribution along channel axis

In this case the normalized power distribution along channel axis is

$$M(x) = \frac{(d/2)}{\sin(d/2)} \cos(dx) \quad (1)$$

where $\alpha = \pi \frac{H}{H'}$ (1')

with H' being the extrapolated length and H being length of the fuel rod.

Eq. (17) of para 3 gives

$$[\theta(x) - \theta_i]_0 = \frac{\sin(\alpha x) + \sin(\alpha/2)}{2 \sin(\alpha/2)} (\theta_{out} - \theta_i)_0 \quad (2)$$

Eq. (18) of para 3 gives

$$V(\sigma, x) = \frac{\alpha}{\sin(\alpha x) + \sin(\alpha/2)} \left\{ \frac{F_s(\sigma) Y(\sigma)}{\alpha^2 + Y^2(\sigma)} \left(\cos(\alpha x) - \cos(\alpha/2) e^{-(x+1/2)Y(\sigma)} \right) + \frac{F_s(\sigma) \alpha^2}{\alpha^2 + Y^2(\sigma)} \left(\frac{\sin(\alpha x)}{\alpha} + \frac{\sin(\alpha/2)}{\alpha} e^{-(x+1/2)Y(\sigma)} \right) \right\} \quad (3)$$

Eqs. (23) and (27) of para 3 give

$$(\bar{\theta} - \theta_i)_0 = (\theta_{eff} - \theta_i)_0 = \frac{1}{2} (\theta_{out} - \theta_i)_0 \quad (4)$$

Eq. (24) of para 3 gives

$$\bar{V}(\sigma) = 2 \frac{F_s(\sigma) Y(\sigma)}{\alpha^2 + Y^2(\sigma)} \left[1 - \frac{1 - e^{-Y(\sigma)}}{Y(\sigma)} \frac{(d/2) \cos(d/2)}{\sin(d/2)} \right] + \frac{F_s(\sigma) \alpha^2}{\alpha^2 + Y^2(\sigma)} \cdot \frac{1 - e^{-Y(\sigma)}}{Y(\sigma)} \quad (5)$$

Eq. (26) of para 2 gives

$$W_{eff}(\sigma) = \frac{2}{1 + \frac{\sin \alpha}{\alpha}} \left\{ \cos^2(\alpha/2) \frac{Y^2(\sigma)}{4\alpha^2 + Y^2(\sigma)} \frac{1 - e^{-Y(\sigma)}}{Y(\sigma)} + \frac{2\alpha^2}{4\alpha^2 + Y^2(\sigma)} \cdot \left(\frac{1 - e^{-Y(\sigma)}}{Y(\sigma)} + \frac{\sin \alpha}{\alpha} \cdot \frac{1 + e^{-Y(\sigma)}}{2} \right) \right\} \quad (6)$$

Eq. (28) of para 3 gives

$$V_{\text{eff}}(\sigma) = 2 \frac{F_s(\sigma)Y(\sigma)}{\alpha^2+Y^2(\sigma)} \left[2 \frac{1 - \frac{1}{3} \sin^2(\alpha/2)}{1 + \frac{\sin \alpha}{\alpha}} - \frac{(\alpha/2)\cos(\alpha/2)}{\sin(\alpha/2)} W_{\text{eff}}(\sigma) \right] + \quad (7)$$

$$+ \frac{F_s(\sigma)}{\alpha^2+Y^2(\sigma)} W_{\text{eff}}(\sigma)$$

Eqs. 11, 15 and 17 give respectively

$$\bar{W}(\sigma; x) = \frac{\alpha}{\sin(\alpha x) + \sin(\alpha/2)} \left\{ \frac{Y(\sigma)}{\alpha^2+Y^2(\sigma)} \left[\cos(\alpha x) - \cos(\alpha/2) e^{-(x+1/2)Y(\sigma)} \right] + \right.$$

$$\left. + \frac{\alpha^2}{\alpha^2+Y^2(\sigma)} \left[\frac{\sin(\alpha x)}{\alpha} + \frac{\sin(\alpha/2)}{\alpha} e^{-(x+1/2)Y(\sigma)} \right] \right\} \quad (8)$$

$$\bar{V}(\sigma) = 2 \frac{Y(\sigma)}{\alpha^2+Y^2(\sigma)} \left[1 - \frac{1-e^{-Y(\sigma)}}{Y(\sigma)} \frac{(\alpha/2)\cos(\alpha/2)}{\sin(\alpha/2)} \right] +$$

$$+ \frac{\alpha^2}{\alpha^2+Y^2(\sigma)} \cdot \frac{1-e^{-Y(\sigma)}}{Y(\sigma)} \quad (9)$$

$$\bar{W}_{\text{eff}}(\sigma) = 2 \frac{Y(\sigma)}{\alpha^2+Y^2(\sigma)} \left[2 \frac{1 - \frac{1}{3} \sin^2(\alpha/2)}{1 + \sin(\alpha/\alpha)} - \frac{(\alpha/2)\cos(\alpha/2)}{\sin(\alpha/2)} W_{\text{eff}}(\sigma) \right] +$$

$$+ \frac{\alpha^2}{\alpha^2+Y^2(\sigma)} W_{\text{eff}}(\sigma) \quad (10)$$

In the next sections of this paragraph the functions $V(\sigma; x)$; $\bar{V}(\sigma)$; $W_{\text{eff}}(\sigma)$ and $V_{\text{eff}}(\sigma)$ are developed in expressions which are easily antitransformable to the time domain.

7.1 Expansion in series of poles of the function $V(\sigma, x)$ in the case of sinusoidal power distribution

The function

$$V(\sigma, x) = \frac{\alpha}{\sin(\alpha x) + \sin(\alpha/2)} \left[\frac{F_s(\sigma)Y(\sigma)}{\alpha^2 + Y^2(\sigma)} \left(\cos(\alpha x) - \cos(\alpha/2) e^{-(x+1/2)Y(\sigma)} \right) + \frac{F_s(\sigma)\alpha^2}{\alpha^2 + Y^2(\sigma)} \left(\frac{\sin(\alpha x)}{\alpha} + \frac{\sin(\alpha/2)}{\alpha} e^{-(x+1/2)Y(\sigma)} \right) \right] \quad (1)$$

can be developed on the imaginary axis ($\sigma = ju$) as follows (see Appendix 10):

$$V(\sigma, x) = v_1 \sum_{n=1}^{n=\infty} D1_n \frac{1+E1_n \sigma}{1+AS_n \sigma + BS_n \sigma^2} + v_2 e^{-(x+1/2)\sigma} \sum_{n=1}^{n=\infty} D2_n \frac{1+E2_n \sigma}{1+AS_n \sigma + BS_n \sigma^2} + v_3 e^{-(x+1/2)\sigma} \sum_{n=1}^{n=\infty} D3_n \frac{1+E3_n \sigma}{1+A_n \sigma + B_n \sigma^2} \quad (2)$$

where

$$v_1 = \frac{1}{\sin(\alpha x) + \sin(\alpha/2)} \quad (3)$$

$$v_2 = \frac{\sin(\alpha/2)}{\sin(\alpha x) + \sin(\alpha/2)} [w_1 + (1-w_1)(1-S_2)] \quad (4)$$

$$v_3 = \frac{\sin(\alpha/2)}{\sin(\alpha x) + \sin(\alpha/2)} (1-w_1)S_2 \quad (5)$$

$$D1_n = \sin(\alpha x) \cdot DS_n + \alpha \cos(\alpha x) DZ_n \quad (6)$$

$$E1_n = \frac{\sin(\alpha x)DS_n ES_n + \alpha \cos(\alpha x) DZ_n EZ_n}{\sin(\alpha x)DS_n + \alpha \cos(\alpha x) DZ_n} \quad (7)$$

$$D2_n = \frac{w_1 DP_n + (1-w_1)(1-S_2)DK2_n}{w_1 + (1-w_1)(1-S_2)} \quad (8)$$

$$E2_n = \frac{w_1 EP_n + (1-w_1)(1-S_2)EK2_n}{w_1 DP_n + (1-w_1)(1-S_2)DK2_n} \quad (9)$$

$$D3_n = DK1_n \quad (10)$$

$$E3_n = \frac{EK1_n}{DK1_n} \quad (11)$$

$w_1; 1-w_1; A_n; B_n$ are given in para. 6.1

$DS_n; ES_n; DZ_n; EZ_n; AS_n; BS_n$ are given in Appendix 8.

$S_2; 1-S_2; DK1_n; EK1_n; DK2_n; EK2_n; DP_n; EP_n$ are given in Appendix 10.

We have

$$v_1 + v_2 + v_3 = 1 \quad (12)$$

$$\sum_{n=1}^{n=\infty} D1_n = \sum_{n=1}^{n=\infty} D2_n = \sum_{n=1}^{n=\infty} D3_n = 1 \quad x \neq 0, \quad \sum_{n=1}^{\infty} D1_n = 0 \quad x=0 \quad (13)$$

$$\sum_{n=1}^{n=\infty} \frac{D1_n E1_n}{BS_n} = 0 \quad (14)$$

$$\sum_{n=1}^{n=\infty} \frac{D1_n}{BS_n} \left(1 - \frac{AS_n E1_n}{BS_n} \right) = \alpha \cos(\alpha x) \frac{1}{\ell \gamma} \quad (15)$$

7.2 Expansion in series of poles of the function $\bar{V}(\sigma)$ in the case of sinusoidal power distribution

The function

$$\bar{V}(\sigma) = 2 \frac{F_s(\sigma) Y(\sigma)}{\alpha^2 + Y^2(\sigma)} \left[1 - \frac{1 - a^{-Y(\sigma)}}{Y(\sigma)} \frac{(\alpha/2) \cos(\alpha/2)}{\sin(\alpha/2)} \right] + \frac{F_s(\sigma) \alpha^2}{\alpha^2 + Y^2(\sigma)} \frac{1 - a^{-Y(\sigma)}}{Y(\sigma)} \quad (1)$$

can be developed on the imaginary axis ($\sigma = j\nu$) as follows (see Appendix 11)

$$\begin{aligned} \bar{V}(\sigma) = & \bar{v}_1 \frac{1 - a^{-\ell\sigma}}{\ell\sigma} + \bar{v}_2 \sum_{n=1}^{\infty} \frac{\bar{L}_n}{1 + \sigma/\sigma_n^*} + \bar{v}_3 a^{-\ell\sigma} \sum_{n=1}^{\infty} \frac{\bar{L}'_n}{1 + \sigma/\sigma_n^*} + \\ & + \bar{v}_4 \sum_{n=1}^{\infty} D4_n \frac{1 + E4_n \sigma}{1 + A5_n \sigma + B5_n \sigma^2} + \bar{v}_5 a^{-\ell\sigma} \sum_{n=1}^{\infty} D5_n \frac{1 + E5_n \sigma}{1 + A5_n \sigma + B5_n \sigma^2} + \\ & + \bar{v}_6 a^{-\ell\sigma} \sum_{n=1}^{\infty} D6_n \frac{1 + E6_n \sigma}{1 + \bar{A}_n \sigma + \bar{B}_n \sigma^2} \end{aligned} \quad (2)$$

where $\bar{v}_1 = \frac{1}{1+m}$ (3)

$$\bar{v}_2 = -\frac{\mu + 1/8}{\ell(1+m)^2} \quad (4)$$

$$\bar{v}_3 = \frac{\mu + 1/8}{\ell(1+m)^2} + \frac{m}{1+m} (1 - \bar{S}_1) \quad (5)$$

$$\bar{v}_4 = -\frac{\cos(\alpha/2)}{\alpha \sin(\alpha/2)} \quad (6)$$

$$\bar{v}_5 = \frac{\cos(\alpha/2)}{\alpha \sin(\alpha/2)} - m(1 - \bar{S}_1) + (1 - S_3) \left(m - \frac{m^2}{1+m} \bar{S}_1 \right) \quad (7)$$

$$\bar{v}_6 = \left(m - \frac{m^2}{1+m} \bar{S}_1 \right) S_3 \quad (8)$$

$$D4_n = \frac{1}{\bar{v}_4} \left[2 DZ_n + \frac{\mu + 1/8}{\ell(1+m)} DK3_n - \frac{DK_n AS_n - EK_n}{\ell(1+m)} \right] \quad (9)$$

$$E4_n = \frac{2DZ_n EZ_n + \frac{\mu+1/8}{\ell(1+m)} EK3_n - \frac{DK_n BS_n}{\ell(1+m)}}{2DZ_n + \frac{\mu+1/8}{\ell(1+m)} DK3_n - \frac{DK_n AS_n - EK_n}{\ell(1+m)}} \quad (10)$$

$$D5_n = \frac{1}{\bar{v}_5} \left[\frac{DK_n AS_n - EK_n}{\ell(1+m)} - \left(\frac{\mu+1/8}{\ell(1+m)} + m(1-\bar{S}_1) \right) DK4_n + \left(m - \frac{m^2 \bar{S}_1}{1+m} \right) (1-S_3) DK5_n \right] \quad (11)$$

$$E5_n = \frac{\frac{DK_n BS_n}{\ell(1+m)} - \left[\frac{\mu+1/8}{\ell(1+m)} + m(1-\bar{S}_1) \right] EK4_n + \left(m - \frac{m^2 \bar{S}_1}{1+m} \right) (1-S_3) EK5_n}{\frac{DK_n AS_n - EK_n}{\ell(1+m)} - \left[\frac{\mu+1/8}{\ell(1+m)} + m(1-\bar{S}_1) \right] DK4_n + \left(m - \frac{m^2 \bar{S}_1}{1+m} \right) (1-S_3) DK5_n} \quad (12)$$

$$D6_n = DK6_n \quad (13)$$

$$E6_n = \frac{EK6_n}{DK6_n} \quad (14)$$

$\bar{S}_1; 1-\bar{S}_1; \bar{A}_n; \bar{B}_n$ being $S_1; 1-S_1; A_n; B_n$ calculated for $x = 1/2$.

$A_n; B_n$ are given in para 6.1.

$\sigma_n^*; S_1; 1-S_1$ are given in para 6.2.

\bar{L}_n, \bar{L}'_n are given in para 6.3.

$AS_n; BS_n; DZ_n; EZ_n$ are given in appendix 8.

$S_3; 1-S_3; DK_n; EK_n; DK3_n; EK3_n; DK4_n; EK4_n; DK5_n;$

$EK5_n; DK6_n; EK6_n$ are given in appendix 11.

It is

$$\sum_{i=1}^{i=6} \bar{v}_i = 1 \quad (15)$$

$$\sum_{n=1}^{n=\infty} D4_n = \sum_{n=1}^{n=\infty} D5_n = \sum_{n=1}^{n=\infty} D6_n = 1 \quad (16)$$

$$\sum_{n=1}^{n=\infty} \frac{D4_n E4_n}{B5_n} = 0 \quad (17)$$

$$\sum_{n=1}^{n=\infty} \frac{D4_n}{B5_n} \left(1 - \frac{A5_n E4_n}{B5_n} \right) = - \frac{2\alpha \sin(\alpha/2)}{\cos(\alpha/2)} \frac{1}{l^2} \quad (18)$$

7.3 Expansion in series of poles of the function $W_{\text{eff}}(\sigma)$ in the case of sinusoidal power distribution

The function

$$W_{\text{eff}}(\sigma) = \frac{2}{1 + \frac{\sin d}{d}} \left\{ \cos^2(d/2) \frac{Y^2(\sigma)}{4d^2 + Y^2(\sigma)} \frac{1 - e^{-Y(\sigma)}}{Y(\sigma)} + \right. \\ \left. + \frac{2d^2}{4d^2 + Y^2(\sigma)} \left(\frac{1 - e^{-Y(\sigma)}}{Y(\sigma)} + \frac{\sin d}{d} \frac{1 + e^{-Y(\sigma)}}{2} \right) \right\} \quad (1)$$

can be developed on the imaginary axis ($\sigma = j\nu$) as follows (see Appendix 13)

$$W_{\text{eff}}(\sigma) = W_{\text{eff}1} \frac{1 - e^{-l\sigma}}{l\sigma} + W_{\text{eff}2} \sum_{n=1}^{n=\infty} \frac{\bar{L}_n}{1 + \sigma/\sigma_n^+} + W_{\text{eff}3} e^{-l\sigma} \sum_{n=1}^{n=\infty} \frac{\bar{L}_n}{1 + \sigma/\sigma_n^+} \\ + W_{\text{eff}4} \sum_{n=1}^{n=\infty} DH1_n \frac{1 + EH1_n \sigma}{1 + AH_n \sigma + BH_n \sigma^2} + W_{\text{eff}5} e^{-l\sigma} \sum_{n=1}^{n=\infty} DH2_n \frac{1 + EH2_n \sigma}{1 + AH_n \sigma + BH_n \sigma^2} \quad (2) \\ + W_{\text{eff}6} e^{-l\sigma} \sum_{n=1}^{n=\infty} DH3_n \frac{1 + EH3_n \sigma}{1 + \bar{A}_n \sigma + \bar{B}_n \sigma^2}$$

where

$$W_{\text{eff}1} = \frac{1}{1 + \frac{\sin d}{d}} \frac{1}{1+m} \quad (3)$$

$$W_{\text{eff}2} = \frac{1}{1 + \frac{\sin d}{d}} m \frac{\mu + 1/8}{l(1+m)^2} \quad (4)$$

$$W_{\text{eff}3} = - \frac{1}{1 + \frac{\sin d}{d}} \frac{m}{1+m} \left[\frac{\mu + 1/8}{l(1+m)} + m(1 - \bar{S}_1) \right] \quad (5)$$

$$W_{\text{eff}4} = \frac{1}{1 + \frac{\sin d}{d}} \frac{\sin d}{2d} \quad (6)$$

$$W_{\text{eff}5} = \frac{1}{1 + \frac{\sin d}{d}} \left[\left(m - \frac{m^2}{1+m} \bar{S}_1 \right) (1 - S_4) + \frac{\sin d}{2d} w_1 + \frac{\sin d}{2d} (1 - w_1)(1 - S_5) \right] \quad (7)$$

$$W_{\text{eff}6} = \frac{1}{1 + \frac{\sin d}{d}} \left[\left(m - \frac{m^2}{1+m} \bar{S}_1 \right) S_4 + \frac{\sin d}{2d} (1 - w_1) S_5 \right] \quad (8)$$

$$DH_1 = DH_n + \frac{4d \cos^2(d/2)}{\sin d} DN_n - \frac{2d}{\sin d} \frac{1}{\ell(1+m)} DH_n (AH_n - EH_n) + \frac{2d}{\sin d} m \frac{\mu + \eta}{\ell(1+m)^2} DK_7_n \quad (9)$$

$$EH_1 = \frac{1}{DH_1} \left[DH_n EH_n + \frac{4d \cos^2(d/2)}{\sin d} DN_n EN_n - \frac{2d}{\sin d} \frac{1}{\ell(1+m)} DH_n BH_n + \frac{2d}{\sin d} m \frac{\mu + \eta}{\ell(1+m)^2} EK_7_n \right] \quad (10)$$

$$DH_2 = \frac{1}{W_{\text{eff}5} \left(1 + \frac{\sin d}{2}\right)} \left\{ \frac{DH_n (AH_n - EH_n)}{\ell(1+m)} - \left[m \frac{\mu + \eta}{\ell(1+m)^2} + \frac{m^2}{1+m} (1 - \bar{S}_1) \right] DK_8_n + \left(m - \frac{m^2 \bar{S}_1}{1+m} \right) (1 - S_4) DK_{10}_n + \frac{\sin d}{2d} \left[w_1 DM_n + (1 - w_1) (1 - S_5) DK_{12}_n \right] \right\} \quad (11)$$

$$EH_2 = \frac{1}{DH_2 W_{\text{eff}5} \left(1 + \frac{\sin d}{2}\right)} \left\{ \frac{DH_n BH_n}{\ell(1+m)} - \left[m \frac{\mu + \eta}{\ell(1+m)^2} + \frac{m^2}{1+m} (1 - \bar{S}_1) \right] EK_8_n + \left(m - \frac{m^2 \bar{S}_1}{1+m} \right) (1 - S_4) EK_{10}_n + \frac{\sin d}{2d} \left[w_1 EM_n + (1 - w_1) (1 - S_5) EK_{12}_n \right] \right\} \quad (12)$$

$$DH_3 = \frac{1}{W_{\text{eff}6} \left(1 + \frac{\sin d}{2}\right)} \left[\left(m - \frac{m^2 \bar{S}_1}{1+m} \right) S_4 DK_9_n + \frac{\sin d}{2d} (1 - w_1) S_5 DK_{11}_n \right] \quad (13)$$

$$EH_3 = \frac{1}{DH_3 W_{\text{eff}6} \left(1 + \frac{\sin d}{2}\right)} \left[\left(m - \frac{m^2 \bar{S}_1}{1+m} \right) S_4 EK_9_n + \frac{\sin d}{2d} (1 - w_1) S_5 EK_{11}_n \right] \quad (14)$$

$\bar{S}_1; 1 - \bar{S}_1; \bar{A}_n; \bar{B}_n$; being $S_1; 1 - S_1; A_n; B_n$ calculated for $x = 1/2$.

w_1 and $1 - w_1$ also calculated for $x = 1/2$.

$w_1; 1 - w_1; A_n; B_n$ are given in para 6.1.

σ_n^* ; $S_1; 1 - S_1$ are given in para 6.2.

$\bar{L}_n; \bar{L}'_n$ are given in para 6.3.

$AH_n; BH_n; DH_n; EH_n; DN_n; EN_n$ are given in appendix 12.

$S_4; 1 - S_4; S_5; 1 - S_5; DM_n; EM_n; DK_7_n; EK_7_n; DK_8_n; EK_8_n; DK_9_n; EK_9_n;$

$DK_{10}_n; EK_{10}_n; DK_{11}_n; EK_{11}_n; DK_{12}_n; EK_{12}_n$ are given in appendix 13.

It is

$$\sum_{i=1}^{i=6} W_{eff i} = 1 \quad (15)$$

$$\sum_{n=1}^{n=\infty} DH1_n = \sum_{n=1}^{n=\infty} DH2_n = \sum_{n=1}^{n=\infty} DH3_n = 1 \quad (16)$$

$$\sum_{n=1}^{n=\infty} \frac{DH1_n EH1_n}{BH_n} = \frac{2d \cos d}{\sin d} \cdot \frac{1}{e} \quad (17)$$

$$\sum_{n=1}^{n=\infty} \frac{DH1_n}{BH_n} \left(1 - \frac{EH1_n AH1_n}{BH_n} \right) = \frac{4d^2}{e^2} \quad (18)$$

7.4 Expansion in series of poles of the function $V_{\text{eff}}(\sigma)$ in the case of sinusoidal power distribution

The function

$$V_{\text{eff}}(\sigma) = 2 \frac{F_s(\sigma) Y(\sigma)}{d^2 + Y^2(\sigma)} \left[2 \frac{1 - \frac{1}{3} \sin^2(\alpha/2)}{1 + \frac{\sin \alpha}{d}} - \frac{(\alpha/2) \cos(\alpha/2)}{\sin(\alpha/2)} W_{\text{eff}}(\sigma) \right] + \frac{F_s(\sigma) d^2}{d^2 + Y^2(\sigma)} W_{\text{eff}}(\sigma) \quad (1)$$

can be developed on the imaginary axis ($\sigma = j\nu$) as follows (see Appendix 14)

$$V_{\text{eff}}(\sigma) = V_{\text{eff}1} \frac{1 - e^{-l\sigma}}{e^{\sigma}} + V_{\text{eff}2} \sum_{n=1}^{\infty} \frac{\bar{L}_n}{1 + \sigma/\sigma_n^+} + V_{\text{eff}3} e^{-l\sigma} \sum_{n=1}^{\infty} \frac{\bar{L}'_n}{1 + \sigma/\sigma_n^+} + V_{\text{eff}4} \sum_{n=1}^{\infty} DI1_n \frac{1 + EI1_n \sigma}{1 + AS_n \sigma + BS_n \sigma^2} + V_{\text{eff}5} \sum_{n=1}^{\infty} DI2_n \frac{1 + EI2_n \sigma}{1 + AH_n \sigma + BH_n \sigma^2} + V_{\text{eff}6} e^{-l\sigma} \sum_{n=1}^{\infty} DI3_n \frac{1 + EI3_n \sigma}{1 + AS_n \sigma + BS_n \sigma^2} + V_{\text{eff}7} e^{-l\sigma} \sum_{n=1}^{\infty} DI4_n \frac{1 + EI4_n \sigma}{1 + AH_n \sigma + BH_n \sigma^2} + V_{\text{eff}8} e^{-l\sigma} \sum_{n=1}^{\infty} DI5_n \frac{1 + EI5_n \sigma}{1 + \bar{A}_n \sigma + \bar{B}_n \sigma^2} \quad (2)$$

where $V_{\text{eff}1} = \frac{1}{1 + \frac{\sin \alpha}{d}} \frac{1}{1+m} \quad (3)$

$$V_{\text{eff}2} = -\frac{1}{1 + \frac{\sin \alpha}{d}} \frac{\mu + 1/8}{e(1+m)^2} \quad (4)$$

$$V_{\text{eff}3} = \frac{1}{1 + \frac{\sin \alpha}{d}} \left[\frac{\mu + 1/8}{e(1+m)^2} + \frac{m}{1+m} (1 - \bar{S}_1) \right] \quad (5)$$

$$V_{\text{eff}4} = \frac{1}{1 + \frac{\sin \alpha}{d}} \left(\frac{\sin \alpha}{2d} S_6 - \frac{\cos(\alpha/2)}{d \sin(\alpha/2)} \right) \quad (6)$$

$$V_{\text{eff}5} = \frac{1}{1 + \frac{\sin \alpha}{d}} \frac{\sin \alpha}{2d} (1 - S_6) \quad (7)$$

$$V_{\text{eff}6} = W_{\text{eff}5} S_7 + W_{\text{eff}6} S_8 + \frac{1}{1 + \frac{\sin \alpha}{d}} \left[\frac{\cos(\alpha/2)}{d \sin(\alpha/2)} - m (1 - \bar{S}_1) \right] \quad (8)$$

$$V_{eff7} = W_{eff5} (1 - S_7) \quad (9)$$

$$V_{eff8} = W_{eff6} (1 - S_8) \quad (10)$$

$$DI1_n = \frac{1}{V_{eff4} (1 + \frac{\sin d}{\alpha})} \left[\frac{\mu + \gamma/8}{\ell(1+m)} DK3_n + \frac{\sin d}{2\alpha} S_6 DL1_n - \right. \\ \left. - \frac{1}{\ell(1+m)} (DK_n AS_n - EK_n) + 4 \frac{1 - \gamma/3 \sin^2(d/2)}{1 + \frac{\sin d}{\alpha}} DZ_n \right] \quad (11)$$

$$EI1_n = \frac{1}{DI1_n V_{eff4} (1 + \frac{\sin d}{\alpha})} \left[\frac{\mu + \gamma/8}{\ell(1+m)} EK3_n + \frac{\sin d}{2\alpha} S_6 EL1_n - \right. \\ \left. - \frac{1}{\ell(1+m)} DK_n BS_n + 4 \frac{1 - \gamma/3 \sin^2(d/2)}{1 + \frac{\sin d}{\alpha}} DZ_n EZ_n \right] \quad (12)$$

$$DI2_n = DL2_n \quad (13)$$

$$EI2_n = \frac{EL2_n}{DL2_n} \quad (14)$$

$$DI3_n = \frac{1}{V_{eff6}} \left[W_{eff5} S_7 DL3_n + W_{eff6} S_8 DL5_n + \frac{DK_n AS_n - EK_n}{(1 + \frac{\sin d}{\alpha})(1+m)\ell} - \right. \\ \left. - \frac{1}{1 + \frac{\sin d}{\alpha}} \left(\frac{\mu + \gamma/8}{\ell(1+m)} + m(1 - \bar{S}_1) \right) DK4_n \right] \quad (15)$$

$$EI3_n = \frac{1}{V_{eff6} DI3_n} \left[W_{eff5} S_7 EL3_n + W_{eff6} S_8 EL5_n + \frac{DK_n BS_n}{(1 + \frac{\sin d}{\alpha})(1+m)\ell} - \right. \\ \left. - \frac{1}{1 + \frac{\sin d}{\alpha}} \left(\frac{\mu + \gamma/8}{\ell(1+m)} + m(1 - \bar{S}_1) \right) EK4_n \right] \quad (16)$$

$$DI4_n = DL4_n \quad (17)$$

$$EI4_n = \frac{EL4_n}{DL4_n} \quad (18)$$

$$DI5_n = DL6_n \quad (19)$$

$$EI5_n = \frac{EL6_n}{DL6_n} \quad (20)$$

$1-\bar{S}_1$; \bar{A}_n ; \bar{B}_n being $1-S_1$; A_n ; B_n calculated for $x=1/2$.

A_n ; B_n are given in para 6.1.

σ_n^* ; $1-S_1$ are given in para 6.2.

\bar{L}_n ; \bar{L}'_n are given in para 6.3.

AS_n ; BS_n ; DZ_n ; EZ_n are given in appendix 8.

DK_n ; EK_n ; $DK3_n$; $EK3_n$; $DK4_n$; $EK4_n$ are given in appendix 11.

W_{eff5} ; W_{eff6} are given in para 7.3.

AH_n ; BH_n are given in appendix 12.

S_6 ; $1-S_6$; S_7 ; $1-S_7$; S_8 ; $1-S_8$; $DL1_n$; $EL1_n$; $DL2_n$; $EL2_n$; $DL3_n$; $EL3_n$; $DL4_n$; $EL4_n$; $DL5_n$; $EL5_n$; $DL6_n$; $EL6_n$ are given in appendix 14.

We have

$$\sum_{i=1}^{i=8} V_{affi} = 1 \quad (21)$$

$$\sum_{n=1}^{n=\infty} DI1_n = \sum_{n=1}^{n=\infty} DI2_n = \sum_{n=1}^{n=\infty} DI3_n = \sum_{n=1}^{n=\infty} DI4_n = \sum_{n=1}^{n=\infty} DI5_n = \sum_{n=1}^{n=\infty} DI6_n = 1 \quad (22)$$

$$V_{aff4} \sum_{n=1}^{n=\infty} \frac{DI1_n EI1_n}{BS_n} + V_{aff5} \sum_{n=1}^{n=\infty} \frac{DI2_n EI2_n}{BH_n} = 0 \quad (23)$$

$$\begin{aligned} V_{eff4} \sum_{n=1}^{n=\infty} \frac{DI1_n}{BS_n} \left(1 - \frac{AS_n EI1_n}{BS_n}\right) + V_{eff5} \sum_{n=1}^{n=\infty} \frac{DI2_n}{BH_n} \left(1 - \frac{AH_n EI2_n}{BH_n}\right) = \\ = 4 \frac{1 - \frac{1}{3} \sin^2(\alpha/2)}{1 + \frac{\sin \alpha}{\alpha}} \frac{1}{l_j} \end{aligned} \quad (24)$$

8. Antitransformation to the time domain

The expressions developed in para. 6 and 7 are easily antitransformable to the time domain.

The following table gives the antitransformed of the elementary functions contained in the equations of para. 6 and 7 (see Bibl. 2).

Laplace transform	Function	
$F(\sigma)$	$f(\tau)$	(1)

$e^{-a\sigma} F(\sigma)$	$f(\tau-a)$ $\tau > a \geq 0$ 0 $\tau \leq a$	(2)
--------------------------	--	-----

$\frac{1}{1+a\sigma}$	$\frac{1}{a} e^{-\frac{\tau}{a}}$	(3)
-----------------------	-----------------------------------	-----

$\frac{1}{(1+a\sigma)^2}$	$\frac{1}{a^2} \tau e^{-\frac{\tau}{a}}$	(4)
---------------------------	--	-----

$\frac{1 + c\sigma}{1+a\sigma+b\sigma^2}$	$\frac{1}{b} e^{-\frac{a}{2b}\tau} \left[\frac{\sin Y\tau}{Y} + c \left(\cos Y\tau - \frac{a}{2b} \frac{\sin Y\tau}{Y} \right) \right]$	(5)
	$Y = \sqrt{\frac{1}{b} - \left(\frac{a}{2b}\right)^2}$	

$\frac{1-e^{-a\sigma}}{a\sigma}$	0 $\tau > a$ $1/a$ $0 < \tau \leq a$	(6)
----------------------------------	---	-----

$\frac{1-e^{-a\sigma}}{a\sigma^2}$	1 $\tau > a$ τ/a $0 \leq \tau \leq a$	(7)
------------------------------------	---	-----

9. Numerical Examples

Some numerical examples have been carried out by using the equations obtained in paragraphs 6 and 7 and the table of the antitransformed given in paragraph 8.

The following numerical examples have been calculated either for a unit step of the inlet coolant temperature " θ_i " [functions $W(\sigma;x)$ and $\bar{W}(\sigma)$] or for a unit pulse of the power "P" [functions $V(\sigma;x)$ and $\bar{V}(\sigma)$].

The time of all the calculated transients is " τ " that is the real time " t " divided by the radial time scale " t_r ".

Fig. 2 shows the transients of the average coolant temperature (curve 1) and of the outlet coolant temperature (curve 2) due to a step of " θ_i ". It is interesting to notice that the two curves differ considerably. This means that the simple lumped axial model in this case can not describe the transient very precisely. Curve 1 can also represent the transient of the outlet coolant temperature due to a step reduction of the coolant flow. Looking at curve 2 of fig. 2 it is important to notice that the transient is characterized by two parts: a step at $\tau=l$ (which is equal to the time needed by the coolant to cross the all channel) followed by a slow transient. Physically, this means that the coolant, during its travel along the channel, receives less power than it would have got if there was no change in the inlet coolant temperature. The difference between the total power produced and that carried out by the coolant is used to heat up the fuel rod to the new equilibrium value. When the fuel has reached the final temperature, it begins again to release the all power to the coolant. For this reason the second part of the transient, being dominated by the fuel time constant, is very slow.

A better understanding of this phenomenon can be obtained by looking at fig. 3 in which the temperature transients at different channel heights are shown. The size of the step is decreasing as we move from the input to the output of the channel.

Fig. 4 shows the outlet and average coolant temperature transients for a smaller coolant speed ($l = 0.02$). The difference between the two curves is more pronounced than in the case shown in fig. 2 ($l = 0.002$). This means that the smaller is the coolant speed, the worse can the lumped model describe the coolant transients.

The size of the step depends on " l " (fig. 5). The bigger is " l ", the smaller is the coolant speed and the smaller is the step size because the longer is the

time it takes to the coolant to cross the all channel. The bigger is "m" the smaller is the step size of the outlet coolant temperature (fig. 6). This becomes clear if one thinks that, because of the definition of "m", the bigger is "m", the bigger is the heat capacity of the fuel which must be heated up to the new equilibrium value.

The initial step size depends also on " γ " (fig. 7). The bigger is " γ ", the bigger is the step size. This becomes clear if one thinks that the bigger is " γ " the smaller is the heat transfer coefficient between fuel and coolant and therefore the more adiabatic is the coolant temperature transient. In the extreme case $\gamma = \infty$ (that is heat transfer coefficient between fuel and coolant equal to zero), the outlet coolant transient would be perfectly adiabatic that is a unit step at $\tau = \ell$.

Fig. 8 shows the transients respectively of the average coolant temperature (curve 1) and of the outlet coolant temperature (curve 2) due to a power pulse. The two transients differ considerably in the first rising part. This means that the lumped model would not describe them correctly.

Fig. 9 shows the coolant temperature transients at different channel heights. We notice that for a given channel section the peak temperature is reached at a time $\tau = \ell(x+1/2)$ which is the time needed by the coolant to travel from the channel input to the section under consideration.

Fig. 10 shows the transients of outlet (curve 2) and average coolant temperature for a smaller coolant speed ($\ell = 0.02$). The difference between the two curves is more pronounced than in the case shown in fig. 8. This means that the smaller is the coolant speed, the worse can the lumped model describe the coolant transients.

The smaller is " ℓ ", the bigger is the peak temperature (fig. 11). This can be easily understood if one thinks that the smaller is " ℓ ", the smaller is the time required by the coolant to cross the all channel and therefore the bigger is the peak temperature.

The bigger is "m" the smaller is the peak temperature (fig. 12) and the bigger is " γ ", the smaller is the peak temperature (fig. 13). Fig. 14 shows the effect of " α " (axial power shape) on the transient of the outlet coolant temperature.

Figs. 15, 16, 17 and 18 show the influence of the number of poles on the accuracy of the calculation of the coolant transients. In figs. 17 and 18 the influence of the "singular pole" which has a large imaginary part (see Appendix 9) is particularly examined.

Appendix 1

In this appendix we intend to obtain the expression (2) of para. 6.1

We start from

$$W(\sigma; x) = e^{-(x+1/2)Y(\sigma)} \quad (1)$$

Substituting in (1) the expression of $Y(\sigma)$ given by eq. (27) of para 2, we get

$$W(\sigma; x) = e^{-(x+1/2)l\sigma} e^{-(x+1/2)lm\sigma F_S(\sigma)} \quad (2)$$

From Bibl. 1 para. 3 we get for $F_S(\sigma)$ the following expression:

$$\sigma F_S(\sigma) = \sigma \sum_{n=1}^{\infty} \frac{\epsilon_{sn}}{1+\sigma/\sigma_n} = \frac{1}{\gamma} \sum \delta_{sn} \frac{\sigma/\sigma_n}{1+\sigma/\sigma_n} \quad (3)$$

where:

$$\delta_{sn} = \frac{\gamma}{0.25+\gamma^2\sigma_n^2} = \gamma\sigma_n \epsilon_{sn} \quad (4)$$

" $-\sigma_n$ " being "n"th root of the equation $1+\frac{\gamma}{Z(\sigma)} = 0$ with $Z(\sigma)$ given by eq. (23) of para. 2

Putting (3) in (2), we get:

$$W(\sigma; x) = e^{-(x+1/2)l\sigma} e^{-\sum_{n=1}^{\infty} a_n \frac{\sigma/\sigma_n}{1+\sigma/\sigma_n}} \quad (5)$$

where

$$a_n = (x+1/2) \frac{lm}{\gamma} \delta_{sn} = (x+1/2) \frac{ml}{0.25+\gamma^2\sigma_n^2} \quad (6)$$

From Appendix 2 eq. 47, we get on the imaginary axis:

$$e^{-a_n} \frac{\sigma/\sigma_n}{1+\sigma/\sigma_n} \approx \frac{1+e^{-a_n/2} A_n \sigma + e^{-a_n} B_n \sigma^2}{1+A_n \sigma + B_n \sigma^2} \quad (7)$$

which is valid only on the imaginary axis, that is when $\sigma=j\nu$

In (7) it is

$$A_n = \frac{a_n}{\sigma_n (1-e^{-a_n/2})} \quad (8)$$

and

$$B_n = \frac{e^{-an/2}}{\sigma_n^2} \quad (9)$$

Putting (7) in (5), we get:

$$W(\sigma; x) = e^{-(x+1/2)l\sigma} \prod_{n=1}^{\infty} \frac{1 + e^{-an/2} A_n \sigma + e^{-an} B_n \sigma^2}{1 + A_n \sigma + B_n \sigma^2} \quad (10)$$

We have:

$$\prod_{k=1}^{\infty} \frac{1 + e^{-ak/2} A_k \sigma + e^{-ak} B_k \sigma^2}{1 + A_k \sigma + B_k \sigma^2} = e^{-an} \prod_{\substack{k=1 \\ k \neq n}}^{\infty} \frac{1 + e^{-ak/2} A_k \sigma + e^{-ak} B_k \sigma^2}{1 + A_k \sigma + B_k \sigma^2} + \quad (11)$$

$$+ (1 - e^{-an}) \frac{1 + e^{-an/2} A_n \sigma + e^{-an} B_n \sigma^2}{1 + A_n \sigma + B_n \sigma^2} \prod_{\substack{k=1 \\ k \neq n}}^{\infty} \frac{1 + e^{-ak/2} A_k \sigma + e^{-ak} B_k \sigma^2}{1 + A_k \sigma + B_k \sigma^2} =$$

$$= e^{-\sum_{k=1}^{\infty} a_k} + (1 - e^{-\sum_{k=1}^{\infty} a_k}) \sum_{k=1}^{\infty} D_k \frac{1 + E_k \sigma}{1 + A_k \sigma + B_k \sigma^2}$$

If " $-\sigma'_n$ " and " $-\sigma''_n$ " are the conjugate roots of the equation:

$$1 + A_n \sigma + B_n \sigma^2 = 0 \quad (12)$$

from eq. 11 we have for $\sigma \rightarrow \sigma'_n$

$$D_n (1 - E_n \sigma'_n) = \frac{1 - e^{-an}}{1 - e^{-\sum_{k=1}^{\infty} a_k}} \left[1 - \sigma'_n \frac{A_n}{1 + e^{-an/2}} \right] \prod_{\substack{k=1 \\ k \neq n}}^{\infty} \frac{1 - e^{-ak/2} A_k \sigma'_n + e^{-ak} B_k (\sigma'_n)^2}{1 - A_k \sigma'_n + B_k (\sigma'_n)^2} \quad (13)$$

and for $\sigma \rightarrow \sigma''_n$

$$D_n (1 - E_n \sigma''_n) = \frac{1 - e^{-an}}{1 - e^{-\sum_{k=1}^{\infty} a_k}} \left[1 - \sigma''_n \frac{A_n}{1 + e^{-an/2}} \right] \prod_{\substack{k=1 \\ k \neq n}}^{\infty} \frac{1 - e^{-ak/2} A_k \sigma''_n + e^{-ak} B_k (\sigma''_n)^2}{1 - A_k \sigma''_n + B_k (\sigma''_n)^2} \quad (14)$$

Eqs. (13) and (14) can be written as follows

$$D_n (1 - E_n \mu_n + j E_n \nu_n) = \frac{1 - e^{-a_n}}{1 - e^{-m_l/\gamma(x+1/2)}} (R_n + j I_n) \quad (15)$$

$$D_n (1 - E_n \mu_n - j E_n \nu_n) = \frac{1 - e^{-a_n}}{1 - e^{-m_l/\gamma(x+1/2)}} (R_n - j I_n) \quad (16)$$

In (15) and (16) it has been taken into account that:

$$\sum_{k=1}^{k=\infty} a_k = \frac{m_l}{\gamma} (x+1/2) \quad (17)$$

R_n and I_n being respectively real and imaginary parts of the expression

$$R_n + j I_n = (1 - \sigma'_n \frac{A_n}{1 + e^{a_n/2}}) \prod_{\substack{k=1 \\ k \neq n}}^{k=\infty} \frac{1 - e^{-a_k/2} A_k \sigma'_n + e^{-a_k} B_k (\sigma'_n)^2}{1 - A_k \sigma'_n + B_k (\sigma'_n)^2} \quad (18)$$

In (16) it has been taken into account the well known property of the analytical functions:

$$(1 - \sigma''_n \frac{A_n}{1 + e^{a_n/2}}) \sum_{\substack{k=1 \\ k \neq n}}^{k=\infty} \frac{1 - e^{-a_k/2} A_k \sigma''_n + e^{-a_k} B_k (\sigma''_n)^2}{1 - A_k \sigma''_n + B_k (\sigma''_n)^2} = R_n - j I_n \quad (19)$$

In (15) and (16) it has also been put:

$$\sigma'_n = \mu_n - j \nu_n \quad (20)$$

$$\sigma''_n = \mu_n + j \nu_n \quad (21)$$

From (15) or (16) we get:

$$D_n = \frac{1 - e^{-a_n}}{1 - e^{-m_l/\gamma(x+1/2)}} \left(\frac{\mu_n}{\nu_n} I_n + R_n \right) \quad (22)$$

and

$$E_n = \frac{1}{\nu_n} \left(\frac{\mu_n}{\nu_n} + \frac{R_n}{I_n} \right)^{-1} \quad (23)$$

Putting (11) in (10), we get:

$$W(\theta; x) = e^{-(x+1/2)l\sigma} \left[w_1 + (1-w_1) \sum_{n=1}^{\infty} D_n \frac{1+E_n \sigma}{1+A_n \sigma + B_n \sigma^2} \right] \quad (24)$$

where:

$$w_1 = e^{-\sum_{n=1}^{\infty} a_n} = e^{-ml/\gamma(x+1/2)} \quad (25)$$

Appendix 2

In this appendix we want to demonstrate that:

$$\exp \left[-a_n \frac{\sigma/\sigma_n}{1+\sigma/\sigma_n} \right] \cong \frac{1+e^{-a_n/2} A_n \sigma + e^{-a_n} B_n \sigma^2}{1+A_n \sigma + B_n \sigma^2} \quad (1)$$

along the imaginary axis that is when $\sigma = j\omega$

In (1) we have:

$$A_n = \frac{a_n}{\sigma_n (1-e^{-a_n/2})} \quad (2)$$

and

$$B_n = \frac{e^{a_n/2}}{\sigma_n^2} \quad (3)$$

We introduce the new variable $x = \sigma/\sigma_n$

$$\exp \left[-a_n \frac{\sigma/\sigma_n}{1+\sigma/\sigma_n} \right] = \exp \left[-a_n \frac{x}{1+x} \right] = e^{-a_n/2} \exp \left[-\frac{a_n}{2} \cdot \frac{x-1}{x+1} \right] \quad (4)$$

Let us consider the function

$$f(x) = \exp \left[-\frac{a_n}{2} \cdot \frac{x-1}{1+x} \right] \quad (5)$$

If in (5) we put $y=1/x$, we get:

$$f\left(\frac{1}{x}\right) = f(y) = \exp \left[\frac{a_n}{2} \frac{x-1}{x+1} \right] = \frac{1}{f(x)} \quad (6)$$

The problem consists in approximating the function $\exp \left[-\frac{a_n}{2} \frac{x-1}{x+1} \right]$ along the imaginary axis (that is when $x=j\omega$) by means of a rational function.

The order of the two polynomials (at numerator and denominator) must be the same. The bigger is the order of the polynomials, the better is the approximation. Numerical evaluations have shown that a rational function with second order polynomials approximate the function $\exp \left[-\frac{a_n}{2} \frac{x-1}{x+1} \right]$ very accurately for most of the practical cases, that is for

$$0 \leq a_n \leq 3 \quad (7)$$

Taking into account eq. 6, the rational function will be of the following type:

$$g(x) = \frac{(1+xx_1)(1+xx_2)}{\left(1+\frac{x}{x_1}\right)\left(1+\frac{x}{x_2}\right)} e^{a_n/2} \quad (8)$$

with

$$x_1 x_2 = e^{-a_n/2} \quad (9)$$

It is necessary to associate another relationship to eq. 9 in order to determine x_1 and x_2

This second condition may be fixed by imposing that

$$\varphi_g(j\cdot 1) = \varphi_f(j\cdot 1) \quad (\text{Case I}) \quad (10)$$

or

$$\lim_{\omega \rightarrow 0} \frac{dg(j\omega)}{d(j\omega)} = \lim_{\omega \rightarrow 0} \frac{df(j\omega)}{d(j\omega)} \quad (\text{Case II}) \quad (11)$$

where φ_g and φ_f are respectively the phases of $g(j\omega)$ and of $f(j\omega)$.

We shall consider the two cases separately.

$$\text{Case I} \quad \varphi_g(j\cdot 1) = \varphi_f(j\cdot 1) \quad (12)$$

We have

$$\begin{aligned} f(j\omega) &= e^{-a_n/2} \exp\left[\frac{j\omega-1}{j\omega+1}\right] = \exp\left[\frac{a_n}{2} \frac{1-\omega^2-2j\omega}{1+\omega^2}\right] \\ &= \exp\left[\frac{a_n}{2} \frac{1-\omega^2}{1+\omega^2}\right] \exp\left[-j \frac{a_n \omega}{1+\omega^2}\right] \end{aligned} \quad (13)$$

From (13) it follows:

$$\left| f(j\omega) \right| = \exp\left[\frac{a_n}{2} \frac{1-\omega^2}{1+\omega^2}\right] \quad (14)$$

and

$$\varphi_f(j\omega) = - \frac{a_n \omega}{1+\omega^2} \quad (15)$$

We have also

$$\left| g(j\omega) \right| = e^{a_n/2} \frac{(1+\omega^2 x_1^2)(1+\omega^2 x_2^2)}{\left(1+\frac{\omega^2}{x_1}\right)\left(1+\frac{\omega^2}{x_2}\right)} \quad (16)$$

and

$$\varphi_g(j\omega) = \arctg \omega x_1 + \arctg \omega x_2 - \arctg \frac{\omega}{x_1} - \arctg \frac{\omega}{x_2} \quad (17)$$

and therefore

$$\varphi_g(j1) = \arctg x_1 + \arctg x_2 - \arctg \frac{1}{x_1} - \arctg \frac{1}{x_2} \quad (18)$$

Since:

$$\arctg \frac{1}{x} = \pi/2 - \arctg x \quad (19)$$

(18) becomes:

$$\varphi_g(j1) = 2\arctg x_1 + 2\arctg x_2 - \pi \quad (20)$$

which can be written as follows

$$\varphi_g(j \cdot 1) = 2 \arctg \frac{x_1+x_2}{1-x_1x_2} - \pi \quad (21)$$

Condition (12) is therefore equivalent to:

$$-\frac{a_n}{2} = 2 \arctg \frac{x_1+x_2}{1-x_1x_2} - \pi \quad (22)$$

(22) can be modified as follows:

$$\frac{x_1+x_2}{1-x_1x_2} = \operatorname{tg} \left(\frac{\pi}{2} - \frac{a_n}{4} \right) = \frac{1}{\operatorname{tg} \frac{a_n}{4}} \quad (23)$$

Taking into account eq. (9), we can finally write condition (12) as follows:

$$x_1+x_2 = \frac{1-e^{-a_n/2}}{\operatorname{tg} \frac{a_n}{4}} \quad (24)$$

Case II $\lim_{\omega \rightarrow 0} \frac{dg(j\omega)}{d(j\omega)} = \lim_{\omega \rightarrow 0} \frac{df(j\omega)}{d(j\omega)} \quad (25)$

We have:

$$\lim_{\omega \rightarrow 0} \frac{dg(j\omega)}{d(j\omega)} = \left(x_1 - \frac{1}{x_1} + x_2 - \frac{1}{x_2} \right) e^{a_n/2} \quad (26)$$

and

$$\lim_{\omega \rightarrow 0} \frac{df(j\omega)}{d(j\omega)} = -a_n e^{a_n/2} \quad (27)$$

Condition (25) becomes:

$$\frac{x_2(x_1^2-1) + x_1(x_2^2-1)}{x_1x_2} = -a_n \quad (28)$$

Taking into account eq. 9, (28) gives:

$$\frac{x_1 e^{-a_n/2} - x_2 + x_2 e^{-a_n/2} - x_1}{e^{-a_n/2}} = -a_n \quad (29)$$

Finally condition (25) can be written as follows

$$x_1 + x_2 = \frac{a_n e^{-a_n/2}}{1 - e^{-a_n/2}} = \frac{a_n}{e^{a_n/2} - 1} \quad (30)$$

In conclusion the two sets of conditions to determine x_1 and x_2 are the following

$$\text{Case I} \quad \begin{cases} x_1 + x_2 = \frac{1 - e^{-a_n/2}}{\operatorname{tg} \frac{a_n}{4}} \\ x_1 x_2 = e^{-a_n/2} \end{cases} \quad (31)$$

and

$$\text{Case II} \quad \begin{cases} x_1 + x_2 = \frac{a_n}{e^{a_n/2} - 1} \\ x_1 x_2 = e^{-a_n/2} \end{cases} \quad (32)$$

Fig. 19 show the two functions

$$N(a_n) = \frac{1 - e^{-a_n/2}}{\operatorname{tg} \frac{a_n}{4}} \quad (35) \quad \text{and} \quad M(a_n) = \frac{a_n}{e^{a_n/2} - 1} \quad (36)$$

Fig. 20 shows the function

$$\xi(a_n) = \frac{M - N}{M} \quad (37)$$

From fig. 19 it appears that if

$$0 \leq a_n \leq 3 \quad (38)$$

the two functions $M(a_n)$ and $N(a_n)$ are practically coincident.

Numerical evaluations carried out on the IBM 7070 computer show that, assuming for x_1 and x_2 the values obtained in case II, the errors in substituting $f(j\omega)$ with $g(j\omega)$ are less than 5% in the amplitude and less than 2° in the phase when $0 \leq a_n \leq 3$.

Figs. 21 and 22 show respectively amplitude and phase of the functions $f(x)$ and $g(x)$ [Case II] with $a_n = 3$.

From eqs. (33) and (34), we get:

$$x_1 = \frac{a_n}{2(e^{a_n/2}-1)} - j \sqrt{e^{-a_n/2} - \left[\frac{a_n}{2(e^{a_n/2}-1)} \right]^2} \quad (39)$$

and

$$x_2 = \frac{a_n}{2(e^{a_n/2}-1)} + j \sqrt{e^{-a_n/2} - \left[\frac{a_n}{2(e^{a_n/2}-1)} \right]^2} \quad (40)$$

For any value of a_n we have:

$$e^{-a_n/2} \geq \left[\frac{a_n}{2(e^{a_n/2}-1)} \right]^2 \quad (41)$$

In fact condition (41) can be written as follows

$$\cosh \frac{a_n}{2} \geq 1 + \frac{a_n^2}{8} \quad (42)$$

which is satisfied for any value of a_n as it can be easily seen by developing $\cosh \frac{a_n}{2}$ in series.

Putting (39) and (40) in (8), we get:

$$g(x) = \frac{1 + x \frac{a_n}{e^{a_n/2}-1} + x^2 e^{-a_n/2}}{1 + \frac{a_n}{(1-e^{-a_n/2})} x + x^2 e^{a_n/2}} e^{a_n/2} \quad (43)$$

Remembering the $x = \sigma/\sigma_n$, we get

$$e^{-a_n/2} \frac{\sigma/\sigma_n}{1+\sigma/\sigma_n} \cong \frac{1 + \sigma \frac{a_n}{(e^{a_n/2}-1)\sigma_n} + \sigma^2 \frac{e^{-a_n/2}}{\sigma_n^2}}{1 + \sigma \frac{a_n}{\sigma_n(1-e^{-a_n/2})} + \sigma^2 \frac{e^{a_n/2}}{\sigma_n^2}} \quad (44)$$

Putting in eq. (44)

$$A_n = \frac{a_n}{\sigma_n(1-e^{-a_n/2})} \quad (45)$$

and

$$B_n = \frac{e^{a_n/2}}{\sigma_n^2} \quad (46)$$

we get

$$e^{-a_n \frac{\sigma/\sigma_n}{1+\sigma/\sigma_n}} \approx \frac{1 + e^{-a_n/2} A_n \sigma + e^{-a_n B_n} \sigma^2}{1 + A_n \sigma + B_n \sigma^2} \quad (47)$$

Appendix 3

In this appendix we intend to obtain the expression 2 of para. 6.2

We start from:

$$V(\sigma; x) = \frac{1}{x+1/2} \frac{F_s(\sigma)}{Y(\sigma)} \left[1 - e^{-(x+1/2)Y(\sigma)} \right] \quad (1)$$

According to eq. 2 of para. 6.1 we have on the imaginary axis:

$$1 - e^{-(x+1/2)Y(\sigma)} \cong 1 - e^{-(x+1/2)l\sigma} + e^{-(x+1/2)l\sigma} (1-w_1) \left[1 - \sum_{n=1}^{n=\infty} D_n \frac{1+E_n \sigma}{1+A_n \sigma + B_n \sigma^2} \right] =$$

$$= 1 - e^{-(x+1/2)l\sigma} + e^{-(x+1/2)l\sigma} (1-w_1) \sigma \sum_{n=1}^{n=\infty} D_n \frac{A_n - E_n}{1+A_n \sigma + B_n \sigma^2} \quad (2)$$

being:

$$\sum_{n=1}^{n=\infty} D_n (A_n - E_n) = \frac{ml(x+1/2)}{1-w_1} \quad (3)$$

According to eqs. 21 and 27, we get:

$$\frac{F_s(\sigma)}{Y(\sigma)} = \frac{1}{l\sigma} \frac{F_s(\sigma)}{1+mF_s(\sigma)} = \frac{1}{l\sigma} \frac{1/\sigma Z(\sigma)}{1 + \frac{\gamma}{Z(\sigma)} + \frac{m}{\sigma Z(\sigma)}} \quad (4)$$

where:

$$Z(\sigma) = - \frac{J_0(\sqrt{-\sigma})}{2\sqrt{-\sigma} J_1(\sqrt{-\sigma})} \quad (5)$$

J_0 and J_1 being Bessel functions of the first kind.

Eq. (4) can be written as follows

$$\frac{F_s(\sigma)}{Y(\sigma)} = \frac{1}{l\sigma} \frac{1}{\sigma [Z(\sigma) + \gamma] + m} \quad (6)$$

We want to demonstrate that

$$\frac{F_s(\sigma)}{Y(\sigma)} = \frac{1}{(1+m)l\sigma} \sum_{n=1}^{n=\infty} \frac{f_n}{1+\sigma/\sigma_n^*} \quad (7)$$

where

" σ_n^* " is the "n"th root of the equation

$$Z(\sigma) + \gamma + \frac{m}{\sigma} = 0 \quad (8)$$

and

$$f_n = \frac{4(1+m)}{(4m+\sigma_n^*)+4(\gamma\sigma_n^*-m)^2} \quad (9)$$

It will be shown in Appendix 4 that all the roots " $-\sigma_n^*$ " of eq. 8 are real and negative.

From eqs. (5) and (6), we obtain:

$$\begin{aligned} f_n &= (1+m) \lim_{\sigma \rightarrow -\sigma_n^*} \left\{ \frac{1+\sigma/\sigma_n^*}{\sigma[Z(\sigma)+\gamma]+m} \right\} = \quad (10) \\ &= (1+m) \lim_{\sigma \rightarrow -\sigma_n^*} \left\{ \frac{(1+\sigma/\sigma_n^*) 2\sqrt{-\sigma} J_1(\sqrt{-\sigma})}{-\sigma J_0(\sqrt{-\sigma})+2(m+\gamma\sigma)\sqrt{-\sigma} J_1(\sqrt{-\sigma})} \right\} = \\ &= (1+m) 2 \frac{\sqrt{\sigma_n^*}}{\sigma_n^*} J_1(\sqrt{\sigma_n^*}) \lim_{\sigma \rightarrow -\sigma_n^*} \left\{ \frac{1}{\frac{d}{d\sigma} [-\sigma J_0(\sqrt{-\sigma})+2(m+\gamma\sigma)\sqrt{-\sigma} J_1(\sqrt{-\sigma})]} \right\} \end{aligned}$$

Since it is:

$$\begin{aligned} \frac{d}{d\sigma} [-\sigma J_0(\sqrt{-\sigma})+2(m+\gamma\sigma)\sqrt{-\sigma} J_1(\sqrt{-\sigma})] &= \quad (11) \\ &= \frac{1}{2} \left[-2 J_0(\sqrt{-\sigma})+\sqrt{-\sigma} J_1(\sqrt{-\sigma})+4\gamma\sqrt{-\sigma} J_1(\sqrt{-\sigma})-(2m+\gamma\sigma)J_0(\sqrt{-\sigma}) \right] \end{aligned}$$

we have:

$$\begin{aligned} \left\{ \frac{d}{d\sigma} [-\sigma J_0(\sqrt{-\sigma})+2(m+\gamma\sigma)\sqrt{-\sigma} J_1(\sqrt{-\sigma})] \right\}_{\sigma=-\sigma_n^*} &= \quad (12) \\ &= -J_0(\sqrt{\sigma_n^*}) + \frac{4\gamma+1}{2} \sqrt{\sigma_n^*} J_1(\sqrt{\sigma_n^*}) - \frac{2m-\gamma\sigma_n^*}{2} J_0(\sqrt{\sigma_n^*}) = \\ &= \frac{\sqrt{\sigma_n^*} J_1(\sqrt{\sigma_n^*})}{2} [4(2m+2-\gamma\sigma_n^*)Z(\sigma_n^*)+4\gamma+1] = \\ &= \frac{\sqrt{\sigma_n^*} J_1(\sqrt{\sigma_n^*})}{2} \left[4\gamma+1-4(2m+2-\gamma\sigma_n^*)\left(\gamma-\frac{m}{\sigma_n^*}\right) \right] = \\ &= \frac{\sqrt{\sigma_n^*} J_1(\sqrt{\sigma_n^*})}{2} \left[\frac{4}{\sigma_n^*} (\gamma\sigma_n^*-m)^2 + \frac{1}{\sigma_n^*} (4m+\sigma_n^*) \right] \end{aligned}$$

Putting (12) in (10), we get:

$$f_n = \frac{4(1+m)}{(4m+\sigma_n^*) + 4(\gamma\sigma_n^* - m)^2} \quad (13)$$

which is equal to eq. 9

Taking into account eqs (2) and (7), eq. 1 becomes:

$$V(\sigma; x) \cong \frac{1}{x+1/2} \frac{1}{1(1+m)} \sum_{n=1}^{\infty} \frac{f_n}{1+\sigma/\sigma_n^*} \left\{ \frac{1-e^{-(x+1/2)1\sigma}}{\sigma} + \right. \\ \left. + (1-w_1) e^{-(x+1/2)1\sigma} \sum_{n=1}^{\infty} D_n (A_n - E_n) \frac{1 + \frac{B_n}{A_n - E_n} \sigma}{1 + A_n \sigma + B_n \sigma^2} \right\} \quad (14)$$

It is:

$$\frac{1-e^{-(x+1/2)1\sigma}}{\sigma} \sum_{n=1}^{\infty} \frac{f_n}{1+\sigma/\sigma_n^*} = \frac{1-e^{-(x+1/2)1\sigma}}{\sigma} - \\ - \left[1-e^{-(x+1/2)1\sigma} \right] \sum_{n=1}^{\infty} \frac{f_n/\sigma_n^*}{1+\sigma/\sigma_n^*} \quad (15)$$

and

$$\left[\sum_{n=1}^{\infty} \frac{f_n}{1+\sigma/\sigma_n^*} \right] \cdot \left[\sum_{n=1}^{\infty} D_n (A_n - E_n) \frac{1 + \frac{B_n}{A_n - E_n} \sigma}{1 + A_n \sigma + B_n \sigma^2} \right] = \\ = \frac{ml(x+1/2)}{1-w_1} \left[S_1 \sum_{n=1}^{\infty} M_n \frac{1+N_n \sigma}{1+A_n \sigma + B_n \sigma^2} + (1-S_1) \sum_{n=1}^{\infty} \frac{f'_n}{1+\sigma/\sigma_n^*} \right] \quad (16)$$

From eq. (16) we obtain:

$$f'_n = \frac{1}{1-S_1} \frac{1-w_1}{ml(x+1/2)} f_n \sum_{k=1}^{\infty} D_k (A_k - E_k) \frac{1 - \frac{B_k}{A_k - E_k} \sigma_n^*}{1 - A_k \sigma_n^* + B_k (\sigma_n^*)^2} \quad (17)$$

and, taking into account eq. (7)

$$M_n (1-N_n \sigma'_n) = \frac{1}{S_1} \frac{1-w_1}{ml(x+1/2)} (1+m) \frac{F_S(-\sigma'_n)}{1+mF_S(-\sigma'_n)} D_n (A_n - E_n) \left(1 - \frac{B_n}{A_n - E_n} \sigma'_n\right) \quad (18)$$

$$M_n (1 - N_n \sigma_n'') = \frac{1}{S_1} \frac{1-w_1}{ml(x+1/2)} (1+m) \frac{F_s(-\sigma_n'')}{1+mF_s(-\sigma_n'')} D_n(A_n - E_n) \left(1 - \frac{B_n}{A_n - E_n} \sigma_n''\right) \quad (19)$$

where $-\sigma_n'$ and $-\sigma_n''$ are the complex conjugate roots of the equation

$$1 + A_n \sigma + B_n \sigma^2 = 0 \quad (20)$$

Putting

$$\sigma_n' = \mu_n - j\nu_n \quad (21)$$

and

$$\sigma_n'' = \mu_n + j\nu_n \quad (22)$$

eqs. (18) and (19) can be written as follows:

$$M_n (1 - N_n \mu_n + jN_n \nu_n) = \frac{1}{S_1} (R_n^v + jI_n^v) \quad (23)$$

$$M_n (1 - N_n \mu_n - jN_n \nu_n) = \frac{1}{S_1} (R_n^v - jI_n^v) \quad (24)$$

" R_n^v " and " I_n^v " being respectively real and imaginary parts of the function

$$\frac{1-w_1}{ml(x+1/2)} (1+m) \frac{F_s(-\sigma_n')}{1+mF_s(-\sigma_n')} D_n(A_n - E_n) \left(1 - \frac{B_n}{A_n - E_n} \sigma_n'\right) \quad (25)$$

From (23) or (24), we get:

$$M_n = \frac{1}{S_1} \left(\frac{\mu_n}{\nu_n} I_n^v + R_n^v \right) \quad (26)$$

and

$$N_n = \frac{1}{\nu_n} \left(\frac{\mu_n}{\nu_n} + \frac{R_n^v}{I_n^v} \right) \quad (27)$$

Since it is:

$$\sum_{n=1}^{n=\infty} M_n = \sum_{n=1}^{n=\infty} f_n' = 1 \quad (28)$$

we get

$$S_1 = \sum_{n=1}^{n=\infty} \left(\frac{\mu_n}{\nu_n} I_n^v + R_n^v \right) \quad (29)$$

and

$$1-S_1 = \frac{1-w_1}{m l(x+1/2)} \sum_{n=1}^{\infty} f_n \left[\sum_{k=1}^{\infty} D_k (A_k - E_k) \frac{1 - \frac{B_k}{A_k - E_k} \sigma_n^*}{1 - A_k \sigma_n^* + B_k (\sigma_n^*)^2} \right] \quad (30)$$

Putting (15) and (16) in (14), we get finally

$$V(\sigma; x) = v_1 \frac{1 - e^{-(x+1/2)l\sigma}}{(x+1/2)l\sigma} + v_2 \sum_{n=1}^{\infty} \frac{P_n}{1 + \sigma/\sigma_n^*} + \quad (31)$$

$$+ v_3 e^{-(x+1/2)l\sigma} \sum_{n=1}^{\infty} \frac{P'_n}{1 + \sigma/\sigma_n^*} + v_4 e^{-(x+1/2)l\sigma} \sum_{n=1}^{\infty} M_n \frac{1 + N_n \sigma}{1 + A_n \sigma + B_n \sigma^2}$$

where

$$v_1 = \frac{1}{1+m} \quad (32)$$

$$v_2 = -\frac{\gamma+1/8}{l(1+m)^2} \frac{1}{x+1/2} \quad (33)$$

$$v_3 = \frac{\gamma+1/8}{l(1+m)^2} \frac{1}{x+1/2} + \frac{m}{1+m} (1-S_1) \quad (34)$$

$$v_4 = \frac{m}{1+m} S_1 \quad (35)$$

$$P_n = \frac{f_n/\sigma_n^*}{\sum_{n=1}^{\infty} f_n/\sigma_n^*} = \frac{1+m}{\gamma+1/8} \frac{1}{\sigma_n^*} f_n \quad (36)$$

because it is

$$\sum_{n=1}^{\infty} \frac{f_n}{\sigma_n^*} = \frac{\gamma+1/8}{1+m} \quad (\text{See Appendix 5}) \quad (37)$$

$$P'_n = \frac{-v_2 P_n + \frac{m}{1+m} (1-S_1) f'_n}{v_3} = \quad (38)$$

$$= f_n \frac{\frac{1}{l(1+m)} \frac{1}{x+1/2} \frac{1}{\sigma_n^*} + \frac{1-w_1}{l(x+1/2)(m+1)} \sum_{k=1}^{\infty} D_k (A_k - E_k) \frac{1 - \frac{B_k}{A_k - E_k} \sigma_n^*}{1 - A_k \sigma_n^* + B_k (\sigma_n^*)^2}}{\frac{1}{x+1/2} \frac{\gamma+1/8}{l(1+m)^2} + \frac{m}{1+m} (1-S_1)}$$

"M_n" and "N_n" are given respectively by eqs. (26) and (27).

It is:

$$v_1 + v_2 + v_3 + v_4 = 1 \quad (39)$$

and

$$\sum_{n=1}^{n=\infty} P_n = \sum_{n=1}^{n=\infty} P'_n = \sum_{n=1}^{n=\infty} M_n = 1 \quad (40)$$

From eq. 1 we get:

$$\lim_{\sigma \rightarrow \infty} V(\sigma; x) = \lim_{\sigma \rightarrow \infty} \frac{1}{x+1/2} \frac{1}{l\gamma\sigma^2} \quad (41)$$

From eq. 31 we get:

$$\begin{aligned} \lim_{\sigma \rightarrow \infty} V(\sigma; x) &= \lim_{\sigma \rightarrow \infty} \left[\frac{v_1}{(x+1/2)l\sigma} + \frac{v_2}{\sigma^2} \sum_{n=1}^{n=\infty} P_n \sigma_n^* - \frac{v_2}{\sigma^2} \sum_{n=1}^{n=\infty} P_n (\sigma_n^*)^2 \right] = \quad (42) \\ &= \lim_{\sigma \rightarrow \infty} \left[\frac{1}{l\sigma(x+1/2)(1+m)} - \frac{1}{l\sigma(x+1/2)(1+m)} + \frac{1}{(x+1/2)l\sigma^2(1+m)} \sum_{n=1}^{n=\infty} f_n \sigma_n^* \right] = \\ &= \frac{1}{(x+1/2)l\sigma^2} \frac{\sum_{n=1}^{n=\infty} f_n \sigma_n^*}{1+m} \end{aligned}$$

Comparing 41 to 42, we get:

$$\sum_{n=1}^{n=\infty} f_n \sigma_n^* = \frac{1+m}{\gamma} \quad (43)$$

or

$$\sum_{n=1}^{n=\infty} P_n (\sigma_n^*)^2 = - \frac{1}{l\gamma(x+1/2)v_2} \quad (44)$$

Appendix 4

In this appendix we want to show that the roots " $-\sigma_n^*$ " of the Bessel function equation

$$Z(\sigma) + \gamma + \frac{m}{\sigma} = 0 \quad (1)$$

are all real and negative.

It is

$$Z(\sigma) = -\frac{J_0(\sqrt{-\sigma})}{2\sqrt{-\sigma} J_1(\sqrt{-\sigma})} = \frac{d \lg [\sqrt{-\sigma} J_1(\sqrt{-\sigma})]}{d\sigma} \quad (2)$$

It is

$$J_1(\sqrt{-\sigma}) = \frac{\sqrt{-\sigma}}{2} \prod_{n=2}^{n=\infty} \left(1 + \frac{\sigma}{b_n}\right) \quad (3)$$

where $\sqrt{b_n}$ are the real zeros of the Bessel function J_1

Taking into account (2) and (3), (1) becomes:

$$\frac{1+m}{\sigma} + \sum_{n=2}^{n=\infty} \frac{1/b_n}{1+\sigma/b_n} = -\gamma \quad (4)$$

If $\sigma=x+jy$ is a root of eq. 4, putting it in (4), we get

$$y \left[\frac{1+m}{x^2+y^2} + \sum_{n=2}^{n=\infty} \frac{1}{(x+b_n)^2+y^2} \right] = 0 \quad (5)$$

Equation 5 is satisfied only if:

$$y = 0 \quad (6)$$

From (6) we can conclude that all the roots of equation (1) are real. Since the coefficients of eq. (4) are all positive, the roots will be also all negative.

Appendix 5

With reference to eq. 37 of Appendix 3, and to eq. 13' of Appendix 7, we want here to show that:

$$\sum_{n=1}^{\infty} \frac{f_n}{\sigma_n^*} = \frac{\gamma+1/8}{1+m} \quad (1)$$

and

$$\sum_{n=1}^{\infty} \frac{f_n}{(\sigma_n^*)^2} = \left[\frac{(\gamma+1/8)^2}{1+m} + \frac{1}{192(1+m)} \right] \quad (2)$$

It is according to eq. 7 of Appendix 3

$$(1+m) \frac{F_S(\sigma)}{1+mF_S(\sigma)} = \sum_{n=1}^{\infty} \frac{f_n}{1+\sigma/\sigma_n^*} \quad (3)$$

It is also

$$\sum_{n=1}^{\infty} \frac{f_n}{1+\sigma/\sigma_n^*} = 1 - \sigma \sum_{n=1}^{\infty} \frac{f_n}{\sigma_n^*} + \sigma^2 \sum_{n=1}^{\infty} \frac{f_n}{(\sigma_n^*)^2} \dots \quad (4)$$

and

$$P(\sigma) = (1+m) \frac{F_S(\sigma)}{1+mF_S(\sigma)} = 1 + \sigma P'(0) + \sigma^2 \frac{P''(0)}{2!} \dots \quad (5)$$

Comparing (4) to (5), we get:

$$\sum_{n=1}^{\infty} \frac{f_n}{\sigma_n^*} = - P'(0) \quad (6)$$

and

$$\sum_{n=1}^{\infty} \frac{f_n}{(\sigma_n^*)^2} = \frac{P''(0)}{2} \quad (7)$$

It is:

$$P'(\sigma) = (1+m) \frac{\left[1+mF_S(\sigma) \right] F'_S(\sigma) - mF_S(\sigma) F'_S(\sigma)}{\left[1+mF_S(\sigma) \right]^2} = \quad (8)$$

$$= \frac{(1+m)F'_S(\sigma)}{\left[1+mF_S(\sigma) \right]^2}$$

$$\begin{aligned}
 F''_S(\sigma) &= (1+m) \frac{F''_S(\sigma) [1+mF_S(\sigma)]^2 - 2m [F'_S(\sigma)]^2 [1+mF_S(\sigma)]}{[1+mF_S(\sigma)]^4} = \quad (9) \\
 &= (1+m) \frac{F''_S(\sigma) [1+mF_S(\sigma)] - 2m [F'_S(\sigma)]^2}{[1+mF_S(\sigma)]^3}
 \end{aligned}$$

Developing the Bessel function in series, we get:

$$F_S(\sigma) = \frac{1 + \frac{\sigma}{8} + \frac{\sigma^2}{192} \dots}{1 + \sigma(\gamma + 1/4) + \sigma^2(\frac{\gamma}{8} + \frac{1}{64}) \dots} \quad (10)$$

From (10) we get

$$F'_S(\sigma) = \frac{\left[\frac{1+2\sigma}{8+192} \dots \right] \left[1 + \sigma(\gamma + \frac{1}{4}) + \sigma^2(\frac{\gamma}{8} + \frac{1}{64}) \dots \right] - \left[1 + \frac{\sigma}{8} + \frac{\sigma^2}{192} \dots \right] \left[(\gamma + 1/4) + 2\sigma(\frac{\gamma}{8} + \frac{1}{64}) \dots \right]}{\left[1 + \sigma(\gamma + 1/4) + \sigma^2(\frac{\gamma}{8} + \frac{1}{64}) \dots \right]^2} \quad (11)$$

$$F'_S(\sigma) = \frac{-(\gamma + \frac{1}{8}) + 2\sigma \left[\frac{1}{192} - \frac{1}{64} - \frac{\gamma}{8} \right] \dots}{\left[1 + \sigma(\gamma + 1/4) \dots \right]^2} \quad (12)$$

From (12) we get

$$F''_S(\sigma) = \frac{\left[2(\frac{1}{192} - \frac{1}{64} - \frac{\gamma}{8}) \dots \right] \left[1 + \sigma(\gamma + \frac{1}{4}) \dots \right]^2 - 2 \left[1 + \sigma(\gamma + \frac{1}{4}) \dots \right] (\gamma + \frac{1}{4}) \left[-(\gamma + \frac{1}{8}) + 2\sigma(\frac{1}{192} - \frac{1}{64} - \frac{\gamma}{8}) \dots \right]}{\left[1 + \sigma(\gamma + 1/4) \dots \right]^4} \quad (13)$$

$$F''_S(\sigma) = \frac{\left[2(\frac{1}{192} - \frac{1}{64} - \frac{\gamma}{8}) + 2(\gamma + 1/4)(\gamma + 1/8) + \sigma [\dots] + \sigma^2 [\dots] \dots \right]}{\left[1 + \sigma(\gamma + 1/4) \dots \right]^3} = \quad (14)$$

$$= \frac{\frac{2}{192} - \frac{2}{64} + \frac{2}{32} + 2\gamma^2 + \frac{2\gamma}{4} + \sigma(\dots) + \dots}{\left[1 + \sigma(\gamma + 1/4) + \dots \right]^3} = 2 \frac{(\gamma + \frac{1}{8})^2 + \frac{1}{192} + \sigma(\dots) + \dots}{\left[1 + \sigma(\gamma + 1/4) + \dots \right]}$$

Putting $\sigma=0$ in 10; 12 and (14), we get

$$F_S(0) = 1 \quad (15)$$

$$F'_S(0) = -(\gamma + 1/8) \quad (16)$$

$$F_s''(0) = 2 \left[(\gamma + 1/8)^2 + \frac{1}{192} \right] \quad (17)$$

Taking into account (15), (16) and (17), for $\zeta=0$ (8) and (9) give:

$$P'(0) = - \frac{\gamma + 1/8}{1+m} \quad (18)$$

and

$$P''(0) = \frac{1}{(1+m)^2} \left[2(1+m) \left[(\gamma + 1/8)^2 + \frac{1}{192} \right] - 2m(\gamma + 1/8)^2 \right] = 2 \left[\left(\frac{\gamma + 1/8}{1+m} \right)^2 + \frac{1}{192(1+m)} \right] \quad (19)$$

Putting (18) and (19) respectively in (6) and (7), we get:

$$\sum_{n=1}^{\infty} \frac{f_n}{\sigma_n^*} = \frac{\gamma + 1/8}{1+m} \quad (20)$$

and

$$\sum_{n=1}^{\infty} \frac{f_n}{(\sigma_n^*)^2} = \left(\frac{\gamma + 1/8}{1+m} \right)^2 + \frac{1}{192(1+m)} \quad (21)$$

Appendix 6

In this appendix we want to obtain the expression 2 of para. 6

We start from

$$\bar{W}(\sigma) = \frac{1 - e^{-Y(\sigma)}}{Y(\sigma)} \quad (1)$$

According to eq. 2 of appendix 3, we have

$$1 - e^{-Y(\sigma)} = 1 - e^{-l\sigma} + e^{-l\sigma} (1 - e^{-\frac{ml}{\gamma}}) \sigma \sum_{n=1}^{\infty} \bar{D}_n (\bar{A}_n - \bar{E}_n) \frac{1 + \frac{\bar{B}_n}{\bar{A}_n - \bar{E}_n} \sigma}{1 + \bar{A}_n \sigma + \bar{B}_n \sigma^2} \quad (2)$$

where \bar{D}_n ; \bar{E}_n ; \bar{A}_n ; and \bar{B}_n are respectively D_n ; E_n ; A_n and B_n calculated for $x = 1/2$

It is according to eq. 3 of appendix 3

$$\sum_{n=1}^{\infty} \bar{D}_n (\bar{A}_n - \bar{E}_n) = \frac{ml}{1 - e^{-ml/\gamma}} \quad (3)$$

It is

$$\frac{1}{Y(\sigma)} = \frac{1}{l\sigma [1 + mF_s(\sigma)]} = \frac{1}{l\sigma} \frac{1}{1 + mF_s(\sigma)} = \frac{1}{l\sigma} - m \frac{F_s(\sigma)}{Y(\sigma)} \quad (4)$$

Taking into account eq. 7 of appendix 3, we get:

$$\frac{1}{Y(\sigma)} = \frac{1}{l\sigma} \left[1 - \frac{m}{1+m} \sum_{n=1}^{\infty} \frac{f_n}{1 + \sigma/\sigma_n^*} \right] \quad (5)$$

Putting (2) and (5) in (1), we obtain

$$\bar{W}(\sigma) = \frac{1 - e^{-l\sigma}}{l\sigma} - \frac{m}{1+m} \frac{1 - e^{-l\sigma}}{l\sigma} \sum_{n=1}^{\infty} \frac{f_n}{1 + \sigma/\sigma_n^*} + \quad (6)$$

$$+ \frac{1 - e^{-\frac{ml}{\gamma}}}{l} e^{-l\sigma} \sum_{n=1}^{\infty} \bar{D}_n (\bar{A}_n - \bar{E}_n) \frac{1 + \frac{\bar{B}_n}{\bar{A}_n - \bar{E}_n} \sigma}{1 + \bar{A}_n \sigma + \bar{B}_n \sigma^2} -$$

$$- \frac{m}{1+m} \frac{1 - e^{-\frac{ml}{\gamma}}}{l} e^{-l\sigma} \left[\sum_{n=1}^{\infty} \frac{f_n}{1 + \sigma/\sigma_n^*} \right] \left[\sum_{n=1}^{\infty} \bar{D}_n (\bar{A}_n - \bar{E}_n) \frac{1 + \frac{\bar{B}_n}{\bar{A}_n - \bar{E}_n} \sigma}{1 + \bar{A}_n \sigma + \bar{B}_n \sigma^2} \right]$$

It is:

$$\frac{1-e^{-l\sigma}}{l\sigma} \sum_{n=1}^{n=\infty} \frac{f_n}{1+\sigma/\sigma_n^*} = \frac{1-e^{-l\sigma}}{l\sigma} - \frac{1-e^{-l\sigma}}{l} \sum_{n=1}^{n=\infty} \frac{f_n/\sigma_n^*}{1+\sigma/\sigma_n^*} \quad (7)$$

According to eq. 16 of Appendix (3), it is:

$$\left[\sum_{n=1}^{n=\infty} \frac{f_n}{1+\sigma/\sigma_n^*} \right] \cdot \left[\sum_{n=1}^{n=\infty} \bar{D}_n (\bar{A}_n - \bar{E}_n) \frac{1 + \frac{\bar{B}_n \sigma}{\bar{A}_n - \bar{E}_n}}{1 + \bar{A}_n \sigma + \bar{B}_n \sigma^2} \right] = \quad (8)$$

$$= \frac{ml}{1-e^{-ml/\gamma}} \left[\bar{S}_1 \sum_{n=1}^{n=\infty} \bar{M}_n \frac{1 + \bar{N}_n \sigma}{1 + \bar{A}_n \sigma + \bar{B}_n \sigma^2} + (1 - \bar{S}_1) \sum_{n=1}^{n=\infty} \frac{\bar{f}'_n}{1 + \sigma/\sigma_n^*} \right]$$

where \bar{S}_1 , \bar{M}_n , \bar{N}_n and \bar{f}'_n are given by the corresponding equations in Appendix 3 calculated for $x = 1/2$.

Putting (7) and (8) in 6, we get finally:

$$\begin{aligned} \bar{W}(\sigma; x) = & \bar{w}_1 \frac{1-e^{-l\sigma}}{l\sigma} + \bar{w}_2 \sum_{n=1}^{n=\infty} \frac{\bar{L}_n}{1+\sigma/\sigma_n^*} + \bar{w}_3 e^{-l\sigma} \sum_{n=1}^{n=\infty} \frac{\bar{L}'_n}{1+\sigma/\sigma_n^*} + \\ & + \bar{w}_4 e^{-l\sigma} \sum_{n=1}^{n=\infty} \bar{C}_n \frac{1 + \bar{G}_n \sigma}{1 + \bar{A}_n \sigma + \bar{B}_n \sigma^2} \end{aligned} \quad (9)$$

where:

$$\bar{w}_1 = \frac{1}{1+m} \quad (10)$$

$$\bar{w}_2 = m \frac{\gamma+1/8}{l(1+m)^2} \quad (11)$$

$$\bar{w}_3 = -m \frac{\gamma+1/8}{l(1+m)^2} - \frac{m^2}{1+m} (1 - \bar{S}_1) \quad (12)$$

$$\bar{w}_4 = m - \frac{m^2}{1+m} \bar{S}_1 \quad (13)$$

$$\bar{L}_n = \frac{1+m}{\gamma+1/8} \frac{f_n}{\sigma_n^*} = \frac{4(1+m)^2}{\sigma_n^*(\gamma+1/8) [(4m+\sigma_n^*)+4(\gamma\sigma_n^*-m)^2]} = P_n \quad (14)$$

$$\bar{L}_n = \frac{m \frac{\gamma+1/8}{1(1+m)^2} \bar{L}_n + \frac{m^2}{1+m} (1-\bar{S}_1) \bar{f}'_n}{m \frac{\gamma+1/8}{1(1+m)^2} + \frac{m^2}{1+m} (1-\bar{S}_1)} = \quad (15)$$

$$= L_n \sigma_n^* \frac{\gamma+1/8}{1(1+m)^2} \cdot \frac{\frac{1}{\sigma_n^*} + (1-e^{-m\ell/\gamma}) \sum_{k=1}^{k=\infty} \bar{D}_k (\bar{A}_k - \bar{E}_k) \frac{1 - \frac{\bar{B}_k}{\bar{A}_k - \bar{E}_k} \sigma_n^*}{1 - \bar{A}_k \sigma_n^* + \bar{B}_k (\sigma_n^*)^2}}{\frac{\gamma+1/8}{1(1+m)^2} + \frac{m}{1+m} (1-\bar{S}_1)}$$

$$\bar{C}_n = \frac{\frac{1-e^{-m\ell/\gamma}}{1} \bar{D}_n (\bar{A}_n - \bar{E}_n) - \frac{m^2}{1+m} \bar{S}_1 \bar{M}_n}{m - \frac{m^2}{1+m} \bar{S}_1} \quad (16)$$

$$\bar{G}_n = \frac{\frac{1-e^{-m\ell/\gamma}}{1} \bar{D}_n \bar{B}_n - \frac{m^2}{1+m} \bar{S}_1 \bar{M}_n \bar{N}_n}{\bar{C}_n \left[m - \frac{m^2}{1+m} \bar{S}_1 \right]} \quad (17)$$

It is:

$$\bar{w}_1 + \bar{w}_2 + \bar{w}_3 + \bar{w}_4 = 1 \quad (18)$$

$$\sum_{n=1}^{n=\infty} \bar{L}_n = \sum_{n=1}^{n=\infty} \bar{L}'_n = \sum_{n=1}^{n=\infty} \bar{C}_n = 1 \quad (19)$$

From eq. 1, we get:

$$\lim_{\sigma \rightarrow \infty} \bar{W}(\sigma) = \lim_{\sigma \rightarrow \infty} \frac{1}{l\sigma} \quad (20)$$

From eq. 9, we get:

$$\lim_{\sigma \rightarrow \infty} \bar{W}(\sigma) = \lim_{\sigma \rightarrow \infty} \left(\frac{\bar{w}_1}{l\sigma} + \frac{\bar{w}_2}{\sigma} \sum_{n=1}^{n=\infty} \bar{L}_n \sigma_n^* \right) = \quad (21)$$

$$= \lim_{\sigma \rightarrow \infty} \left(\frac{1}{(1+m)l\sigma} + \frac{m}{(1+m)l\sigma} \right) = \lim_{\sigma \rightarrow \infty} \frac{1}{l\sigma}$$

Appendix 7

In this appendix we intend to calculate the expression (2) of para. 6.4

We start from

$$\bar{V}(\sigma) = 2 \frac{F_s(\sigma)}{Y(\sigma)} \left[1 - \frac{1 - e^{-Y(\sigma)}}{Y(\sigma)} \right] \quad (1)$$

According to eq. 7 of Appendix 3 it is

$$2 \frac{F_s(\sigma)}{Y(\sigma)} = \frac{2}{1(1+m)\sigma} \sum_{n=1}^{n=\infty} \frac{f_n}{1 + \frac{\sigma}{\sigma_n^*}} \quad (2)$$

According to eq. 9 of Appendix 6, it is:

$$1 - \frac{1 - e^{-Y(\sigma)}}{Y(\sigma)} \cong \bar{w}_1 \left[1 - \frac{1 - e^{-l\sigma}}{l\sigma} \right] + \bar{w}_2 \left[1 - \sum_{n=1}^{n=\infty} \frac{\bar{L}_n}{1 + \frac{\sigma}{\sigma_n^*}} \right] + (\bar{w}_3 + \bar{w}_4)(1 - e^{-l\sigma}) + e^{-l\sigma} \left[\bar{w}_3 \left(1 - \sum_{n=1}^{n=\infty} \frac{\bar{L}'_n}{1 + \frac{\sigma}{\sigma_n^*}} \right) + \bar{w}_4 \left(1 - \sum_{n=1}^{n=\infty} \bar{C}_n \frac{1 + \bar{G}_n \sigma}{1 + \bar{A}_n \sigma + \bar{B}_n \sigma^2} \right) \right] \quad (3)$$

Taking into account that:

$$1 - \sum_{n=1}^{n=\infty} \frac{\bar{L}_n}{1 + \frac{\sigma}{\sigma_n^*}} = \sigma \sum_{n=1}^{n=\infty} \frac{\bar{L}_n / \sigma_n^*}{1 + \sigma / \sigma_n^*} \quad (4)$$

$$1 - \sum_{n=1}^{n=\infty} \frac{\bar{L}'_n}{1 + \sigma / \sigma_n^*} = \sigma \sum_{n=1}^{n=\infty} \frac{\bar{L}'_n / \sigma_n^*}{1 + \sigma / \sigma_n^*} \quad (5)$$

$$1 - \sum_{n=1}^{n=\infty} \bar{C}_n \frac{1 + \bar{G}_n \sigma}{1 + \bar{A}_n \sigma + \bar{B}_n \sigma^2} = \sigma \sum_{n=1}^{n=\infty} \bar{C}_n (\bar{A}_n - \bar{G}_n) \frac{1 + \frac{\bar{B}_n}{\bar{A}_n - \bar{G}_n} \sigma}{1 + \bar{A}_n \sigma + \bar{B}_n \sigma^2} \quad (6)$$

eq. 1 becomes:

$$\bar{V}(\sigma) = \frac{2}{1(1+m)} \sum_{n=1}^{n=\infty} \frac{f_n}{1 + \frac{\sigma}{\sigma_n^*}} \left\{ \bar{w}_1 \left[\frac{1}{\sigma} - \frac{1 - e^{-l\sigma}}{l\sigma^2} \right] + \bar{w}_2 \sum_{n=1}^{n=\infty} \frac{\bar{L}_n / \sigma_n^*}{1 + \sigma / \sigma_n^*} + \dots \right\} \quad (7)$$

$$+ (\bar{w}_3 + \bar{w}_4) \frac{1 - e^{-1\sigma}}{\sigma} + e^{-1\sigma} \left[\bar{w}_3 \sum_{n=1}^{\infty} \frac{\bar{L}'_n / \sigma_n^*}{1 + \sigma / \sigma_n^*} + \bar{w}_4 \sum_{n=1}^{\infty} \bar{C}_n (\bar{A}_n - \bar{G}_n) \frac{1 + \frac{\bar{B}_n}{\bar{A}_n - \bar{G}_n} \sigma}{1 + \bar{A}_n \sigma + \bar{B}_n \sigma^2} \right] \quad (7)$$

Putting in (7) $\sigma = 0$, we get:

$$\frac{2}{1(1+m)} \bar{w}_4 \sum_{n=1}^{\infty} \bar{C}_n (\bar{A}_n - \bar{G}_n) = \frac{m^2}{(1+m)^2} + \frac{2m(\gamma+1/8)}{1(1+m)^3} + \frac{2m^2}{1(1+m)^2} (1 - \bar{S}_1) \sum_{n=1}^{\infty} \frac{\bar{f}'_n}{\sigma_n^*} \quad (8)$$

Taking into account eqs. 17 and 13 of Appendix 3, we have:

$$\sum_{n=1}^{\infty} \frac{\bar{f}'_n}{\sigma_n^*} = \frac{1 - w_1}{m l(x+1/2)} \frac{1}{1 - S_1} \sum_{n=1}^{\infty} \frac{4(1+m)}{(4m + \sigma_n^*) + (\gamma \sigma_n^* - m)^2} \frac{1}{\sigma_n^*} \left[\sum_{k=1}^{\infty} D_k (A_k - E_k) \frac{1 - \frac{B_k}{A_k - E_k} \sigma_n^*}{1 - A_k \sigma_n^* + B_k (\sigma_n^*)^2} \right] \quad (9)$$

Putting:

$$K = \frac{2(1-w_1)m}{1^2(1+m)^2(x+1/2)} \sum_{n=1}^{\infty} \frac{4(1+m)/\sigma_n^*}{(4m + \sigma_n^*) + (\gamma \sigma_n^* - m)^2} \left[\sum_{k=1}^{\infty} D_k (A_k - E_k) \frac{1 - \frac{B_k}{A_k - E_k} \sigma_n^*}{1 - A_k \sigma_n^* + B_k (\sigma_n^*)^2} \right] =$$

$$= \frac{2(1-w_1)m}{1^2(1+m)^2(x+1/2)} \frac{\gamma+1/8}{1+m} \sum_{n=1}^{\infty} L_n \left[\sum_{k=1}^{\infty} D_k (A_k - E_k) \frac{1 - \frac{B_k}{A_k - E_k} \sigma_n^*}{1 - A_k \sigma_n^* + B_k (\sigma_n^*)^2} \right] = \frac{2m^2(1-S_1)}{1(1+m)^2} \sum_{n=1}^{\infty} \frac{\bar{f}'_n}{\sigma_n^*} \quad (10)$$

eq. (8) becomes:

$$\frac{2}{1(1+m)} \bar{w}_4 \sum_{n=1}^{\infty} \bar{C}_n (\bar{A}_n - \bar{G}_n) = \frac{m^2}{(1+m)^2} + \frac{2m(\gamma+1/8)}{1(1+m)^3} + \bar{K} \quad (11)$$

where: $\bar{K} = (K)_{x=1/2}$

(11¹)

It is:

$$\frac{2\bar{w}_1}{1(1+m)} \left[\sum_{n=1}^{\infty} \frac{f_n}{1+\sigma/\sigma_n^*} \right] \left[\frac{1}{\sigma} - \frac{1-e^{-1\sigma}}{1\sigma^2} \right] = \frac{2\bar{w}_1}{1(1+m)} \frac{\gamma+1/8}{1+m} \left[\sum_{n=1}^{\infty} \frac{L_n \sigma_n^*}{1+\sigma/\sigma_n^*} \right] \left[\frac{1}{\sigma} - \frac{1-e^{-1\sigma}}{1\sigma^2} \right] = \quad (12)$$

$$= \frac{\bar{w}_1}{1+m} \frac{2}{1\sigma} - \frac{2\bar{w}_1}{1(1+m)} \frac{\gamma+1/8}{1+m} \sum_{n=1}^{\infty} \frac{\bar{L}_n}{1+\sigma/\sigma_n^*} - \frac{\bar{w}_1}{1+m} \frac{1-e^{-1\sigma}}{1\sigma^2} + \frac{2(\gamma+1/8)\bar{w}_1}{1(1+m)^2} \frac{1-e^{-1\sigma}}{1\sigma} - \frac{2\bar{w}_1}{1^2(1+m)} \frac{\gamma+1/8}{1+m} (1-e^{-1\sigma}) \sum_{n=1}^{\infty} \frac{\bar{L}_n/\sigma_n^*}{1+\sigma/\sigma_n^*}$$

and:

$$\frac{2\bar{w}_2}{1(1+m)} \left[\sum_{n=1}^{\infty} \frac{f_n}{1+\sigma/\sigma_n^*} \right] \left[\sum_{n=1}^{\infty} \frac{\bar{L}_n/\sigma_n^*}{1+\sigma/\sigma_n^*} \right] = \frac{2\bar{w}_2}{1(1+m)} \frac{\gamma+1/8}{1+m} \left[\sum_{n=1}^{\infty} \frac{\bar{L}_n \sigma_n^*}{1+\sigma/\sigma_n^*} \right] \left[\sum_{n=1}^{\infty} \frac{\bar{L}_n/\sigma_n^*}{1+\sigma/\sigma_n^*} \right] = \quad (13)$$

$$= \left[\frac{2m(\gamma+1/8)^2}{1^2(1+m)^4} + \frac{2m}{192 1^2(1+m)^3} \right] \left[(1-S_3) \sum_{n=1}^{\infty} \frac{g_n}{1+\sigma/\sigma_n^*} + S_3 \sum_{n=1}^{\infty} \frac{\bar{Q}_n}{(1+\sigma/\sigma_n^*)^2} \right]$$

Note that:

$$\sum_{n=1}^{\infty} \frac{L_n}{\sigma_n^*} = \frac{1+m}{\gamma+1/8} \sum_{n=1}^{\infty} \frac{f_n}{(\sigma_n^*)^2} = \frac{1+m}{\gamma+1/8} \left[\left(\frac{\gamma+1/8}{1+m} \right)^2 + \frac{1}{192(1+m)} \right] \quad (\text{See Appendix 5}) \quad (13')$$

It is:

$$g_n = \frac{1}{1-S_3} \frac{(\gamma+1/8)/(1+m)}{\frac{\gamma+1/8}{1+m} + \frac{1}{192(\gamma+1/8)}} \left[L_n \sigma_n^* \sum_{\substack{k=1 \\ k \neq n}}^{\infty} \frac{\bar{L}_k/\sigma_k^*}{1-\sigma_n^*/\sigma_k^*} + \frac{\bar{L}_n}{\sigma_n^*} \sum_{\substack{k=1 \\ k \neq n}}^{\infty} \frac{\bar{L}_k \sigma_k^*}{1-\sigma_n^*/\sigma_k^*} \right] = \quad (14)$$

$$= \frac{1}{1-S_3} \frac{(\gamma+1/8)/(1+m)}{\frac{\gamma+1/8}{1+m} + \frac{1}{192(\gamma+1/8)}} \bar{L}_n \sum_{\substack{k=1 \\ k \neq n}}^{\infty} \frac{\sigma_k^*}{\sigma_n^*} \frac{\bar{L}_k}{1-\sigma_n^*/\sigma_k^*} \frac{1+(\frac{n}{\sigma_k^*})}{\sigma_k^*}$$

$$\bar{Q}_n = \frac{1}{S_3} \frac{(\gamma+1/8)/(1+m)}{\frac{\gamma+1/8}{1+m} + \frac{1}{192(\gamma+1/8)}} \bar{L}_n^2 \quad (15)$$

$$1-S_3 = \frac{(\gamma+1/8)/(1+m)}{\frac{\gamma+1/8}{1+m} + \frac{1}{192(\gamma+1/8)}} \sum_{n=1}^{\infty} \bar{L}_n \left[\sum_{\substack{k=1 \\ k \neq n}}^{\infty} \frac{\sigma_k^*}{\sigma_n^*} \bar{L}_k \frac{1 + \left(\frac{\sigma_n^*}{\sigma_k^*}\right)^2}{1 - \sigma_n^*/\sigma_k^*} \right] \quad (16)$$

$$S_3 = \frac{(\gamma+1/8)/(1+m)}{\frac{\gamma+1/8}{1+m} + \frac{1}{192(\gamma+1/8)}} \sum_{n=1}^{\infty} \bar{L}_n^2 \quad (17)$$

It is also:

$$\frac{2}{1(1+m)(\bar{w}_3 + \bar{w}_4)} \frac{1-e^{-l\sigma}}{\sigma} \sum_{n=1}^{\infty} \frac{f_n}{1+\sigma/\sigma_n^*} = \frac{2(\bar{w}_3 + \bar{w}_4)}{1(1+m)} \left[\frac{1-e^{-l\sigma}}{\sigma} - (1-e^{-l\sigma}) \frac{\gamma+1/8}{1+m} \sum_{n=1}^{\infty} \frac{\bar{L}_n}{1+\sigma/\sigma_n^*} \right] \quad (18)$$

and

$$e^{-l\sigma} \frac{2\bar{w}_3}{1(1+m)} \left[\sum_{n=1}^{\infty} \frac{f_n}{1+\sigma/\sigma_n^*} \right] \left[\sum_{n=1}^{\infty} \frac{\bar{L}'_n/\sigma_n^*}{1+\sigma/\sigma_n^*} \right] = e^{-l\sigma} \frac{2\bar{w}_3}{1(1+m)} \frac{\gamma+1/8}{1+m} \left[\sum_{n=1}^{\infty} \frac{\bar{L}_n \sigma_n^*}{1+\sigma/\sigma_n^*} \right] \left[\sum_{n=1}^{\infty} \frac{\bar{L}'_n/\sigma_n^*}{1+\sigma/\sigma_n^*} \right] =$$

$$= -e^{-l\sigma} \left[\frac{2m(\gamma+1/8)^2}{1^2(1+m)^4} + \frac{2m}{192 \cdot 1^2(1+m)^3} + \bar{K} \right] \left[(1-S_4) \sum_{n=1}^{\infty} \frac{c_n}{1+\sigma/\sigma_n^*} + S_4 \sum_{n=1}^{\infty} \frac{\bar{Q}'_n}{(1+\sigma/\sigma_n^*)^2} \right] \quad (19)$$

Note that:

$$\sum_{n=1}^{\infty} \frac{\bar{L}'_n}{\sigma_n^*} = -\frac{\bar{w}_2}{\bar{w}_3} \sum_{n=1}^{\infty} \frac{\bar{L}_n}{\sigma_n^*} - \frac{\bar{K}}{\bar{w}_3} \quad (19^1)$$

\bar{K} is defined by eq. 10

$$c_n = \frac{1}{1-S_4} \frac{\frac{m(\gamma+1/8)}{1(1+m)^2} + \frac{m^2}{1+m} (1-\bar{S}_1)}{\frac{m}{1(1+m)} \left[\left(\frac{\gamma+1/8}{1+m} \right)^2 + \frac{1}{192(1+m)} \right] + \bar{K}} \left[\bar{L}_n \sigma_n^* \sum_{\substack{k=1 \\ k \neq n}}^{k=\infty} \frac{\bar{L}'_k / \sigma_k^*}{1 - \sigma_n^* / \sigma_k^*} + \frac{\bar{L}'_n}{\sigma_n^*} \sum_{\substack{k=1 \\ k \neq n}}^{k=\infty} \frac{\bar{L}_k \sigma_k^*}{1 - \sigma_n^* / \sigma_k^*} \right] \frac{\gamma+1/8}{1+m} = \quad (20)$$

$$= \frac{1}{1-S_4} \frac{\frac{m(\gamma+1/8)}{1(1+m)^2} + \frac{m^2}{1+m} (1-\bar{S}_1)}{\frac{m}{1(1+m)} \left[\left(\frac{\gamma+1/8}{1+m} \right)^2 + \frac{1}{192(1+m)} \right] + \bar{K}} \sum_{\substack{k=1 \\ k \neq n}}^{k=\infty} \frac{\frac{\sigma_n^*}{\sigma_k^*} \bar{L}_n \bar{L}'_k + \frac{\sigma_k^*}{\sigma_n^*} \bar{L}'_n \bar{L}_k}{1 - \sigma_n^* / \sigma_k^*} \frac{\gamma+1/8}{1+m}$$

$$\bar{Q}'_n = \frac{1}{S_4} \frac{\frac{m(\gamma+1/8)}{1(1+m)^2} + \frac{m^2}{1+m} (1-\bar{S}_1)}{\frac{m}{1(1+m)} \left[\left(\frac{\gamma+1/8}{1+m} \right)^2 + \frac{1}{192(1+m)} \right] + \bar{K}} \bar{L}_n \bar{L}'_n \frac{\gamma+1/8}{1+m} \quad (21)$$

$$1-S_4 = \frac{\frac{m(\gamma+1/8)}{1(1+m)^2} + \frac{m^2}{1+m} (1-\bar{S}_1)}{\frac{m}{1(1+m)} \left[\left(\frac{\gamma+1/8}{1+m} \right)^2 + \frac{1}{192(1+m)} \right] + \bar{K}} \sum_{n=1}^{n=\infty} \left[\sum_{\substack{k=1 \\ k \neq n}}^{k=\infty} \frac{\frac{\sigma_n^*}{\sigma_k^*} \bar{L}_n \bar{L}'_k + \frac{\sigma_k^*}{\sigma_n^*} \bar{L}'_n \bar{L}_k}{1 - \sigma_n^* / \sigma_k^*} \right] \frac{\gamma+1/8}{1+m} \quad (22)$$

$$S_4 = \frac{\frac{m(\gamma+1/8)}{1(1+m)^2} + \frac{m^2}{1+m} (1-\bar{S}_1)}{\frac{m}{1(1+m)} \left[\left(\frac{\gamma+1/8}{1+m} \right)^2 + \frac{1}{192(1+m)} \right] + \bar{K}} \sum_{n=1}^{n=\infty} \bar{L}_n \bar{L}'_n \frac{\gamma+1/8}{1+m} \quad (23)$$

It is:

$$\frac{2}{1(1+m)} e^{-1\sigma} \bar{w}_4 \left[\sum_{n=1}^{\infty} \frac{f_n}{1+\sigma/\sigma_n^*} \right] \left[\sum_{n=1}^{\infty} \bar{c}_n (\bar{A}_n - \bar{G}_n) \frac{1 + \frac{\bar{B}_n}{\bar{A}_n - \bar{G}_n}}{1 + \bar{A}_n \sigma + \bar{B}_n \sigma^2} \right] = \quad (24)$$

$$= e^{-1\sigma} \left[\left(\frac{m}{1+m} \right)^2 + \frac{2m(\gamma+1/8)}{1(1+m)^3} + \bar{K} \right] \left[S_2 \sum_{n=1}^{\infty} \bar{Z}_n \frac{1 + \bar{H}_n \sigma}{1 + \bar{A}_n \sigma + \bar{B}_n \sigma^2} + (1-S_2) \sum_{n=1}^{\infty} \frac{e_n}{1+\sigma/\sigma_n^*} \right]$$

Using the same procedure as that used for eq. 16 of Appendix 3, we get from eq. 24:

$$\bar{Z}_n = \frac{1}{S_2} \left(\frac{\bar{\mu}_n}{\bar{v}_n} I_n^W + R_n^W \right) \quad (25)$$

$$\bar{H}_n = \frac{1}{\bar{v}_n} \left/ \left(\frac{\bar{\mu}_n}{\bar{v}_n} + \frac{R_n^W}{I_n^W} \right) \right. \quad (26)$$

$$S_2 = \frac{\frac{2\bar{w}_4}{1(1+m)}}{\left(\frac{m}{1+m} \right)^2 + \frac{2m(\gamma+1/8)}{1(1+m)^3} + \bar{K}} \sum_{n=1}^{\infty} \left(\frac{\bar{\mu}_n}{\bar{v}_n} I_n^W + R_n^W \right) \quad (27)$$

$$e_n = \frac{1}{1-S_2} \frac{\frac{2\bar{w}_4}{1(1+m)} \frac{\gamma+1/8}{(1+m)}}{\frac{m^2}{(1+m)^2} + \frac{2m(\gamma+1/8)}{1(1+m)^3} + \bar{K}} \bar{L}_n \sigma_n^* \sum_{k=1}^{\infty} \bar{c}_k (\bar{A}_k - \bar{G}_k) \frac{1 - \frac{\bar{B}_k}{\bar{A}_k - \bar{G}_k} \sigma_n^*}{1 - \bar{A}_k \sigma_n^* + \bar{B}_k (\sigma_n^*)^2} \quad (28)$$

$$1-S_2 = \frac{\frac{2\bar{w}_4}{1(1+m)} \frac{\gamma+1/8}{(1+m)}}{\frac{m^2}{(1+m)^2} + \frac{2m(\gamma+1/8)}{1(1+m)^3} + \bar{K}} \sum_{n=1}^{\infty} \bar{L}_n \sigma_n^* \left[\sum_{k=1}^{\infty} \bar{C}_k (\bar{A}_k - \bar{G}_k) \frac{1 - \frac{\bar{B}_k}{\bar{A}_k - \bar{G}_k} \sigma_n^*}{1 - \bar{A}_k \sigma_n^* + \bar{B}_k (\sigma_n^*)^2} \right] \quad (29)$$

R_n^W and I_n^W being respectively real and imaginary parts of the function

$$\frac{\frac{2\bar{w}_4}{1(1+m)} (1+m)}{\left(\frac{m}{1+m}\right)^2 + \frac{2m(\gamma+1/8)}{1(1+m)^3} + \bar{K}} \frac{F_s(-\bar{\sigma}'_n)}{1+m F_s(-\bar{\sigma}'_n)} \bar{C}_n (\bar{A}_n - \bar{G}_n) \left(1 - \frac{\bar{B}_n}{\bar{A}_n - \bar{G}_n} \bar{\sigma}'_n\right) \quad (30)$$

where:

$$\bar{\sigma}'_n = \bar{\mu}_n - j\bar{v}_n \quad (\text{Note: } \bar{\sigma}'_n \text{ means } \sigma'_n \text{ at } x=1/2) \quad (31)$$

and

$$\bar{\mu}_n = + \frac{\bar{A}_n}{2\bar{B}_n} \quad (32)$$

$$\bar{v}_n = \sqrt{\frac{1}{\bar{B}_n} - \left(\frac{\bar{A}_n}{2\bar{B}_n}\right)^2} \quad (33)$$

Putting the expressions (12), (13), (18), (19) and (24) in eq. 7, we get:

$$\begin{aligned} \bar{V}(\sigma) = & \bar{v}_1 \frac{1-e^{-1\sigma}}{1\sigma} - \bar{v}_2 \frac{1-e^{-1\sigma}}{\frac{1}{2} 1^2 \sigma^2} + \bar{v}_2 \frac{2}{1\sigma} + \bar{v}_3 \sum_{n=1}^{\infty} \frac{\bar{P}_n}{1+\sigma/\sigma_n^*} + \bar{v}_4 e^{-1\sigma} \sum_{n=1}^{\infty} \frac{\bar{P}'_n}{1+\sigma/\sigma_n^*} + \bar{v}_5 \sum_{n=1}^{\infty} \frac{\bar{Q}_n}{(1+\sigma/\sigma_n^*)^2} + \\ & + \bar{v}_6 e^{-1\sigma} \sum_{n=1}^{\infty} \frac{\bar{Q}'_n}{(1+\sigma/\sigma_n^*)^2} + \bar{v}_7 e^{-1\sigma} \sum_{n=1}^{\infty} \bar{Z}_n \frac{1+\bar{H}_n \sigma}{1+\bar{A}_n \sigma + \bar{B}_n \sigma^2} \end{aligned} \quad (34)$$

where:

$$\bar{v}_1 = \frac{2(\gamma+1/8)}{1(1+m)^2} \bar{w}_1 + \frac{2(\bar{w}_3 + \bar{w}_4)}{1+m} \quad (35)$$

$$\bar{v}_2 = \frac{\bar{w}_1}{1+m} \quad (36)$$

$$\bar{v}_3 = -\frac{2\bar{w}_1}{1(1+m)} \frac{\gamma+1/8}{(1+m)} - \frac{2\bar{w}_1}{1^2(1+m)} \left[\left(\frac{\gamma+1/8}{1+m} \right)^2 + \frac{1}{192(1+m)} \right] + \left[\frac{2m(\gamma+1/8)^2}{1^2(1+m)^4} + \frac{2m}{192 \cdot 1^2(1+m)^3} \right] \left[1-s_3 \right] - \frac{2(\bar{w}_3 + \bar{w}_4)}{1(1+m)} \frac{\gamma+1/8}{1+m} \quad (37)$$

$$\bar{v}_4 = +\frac{2\bar{w}_1}{1^2(1+m)} \left[\left(\frac{\gamma+1/8}{1+m} \right)^2 + \frac{1}{192(1+m)} \right] + \frac{2(\bar{w}_3 + \bar{w}_4)}{1(1+m)} \frac{\gamma+1/8}{1+m} - \left[\frac{2m(\gamma+1/8)^2}{1^2(1+m)^4} + \frac{2m}{192 \cdot 1^2(1+m)^3} + \bar{K} \right] \left[1-s_4 \right] + \quad (38)$$

$$+ \left[\left(\frac{m}{1+m} \right)^2 + \frac{2m(\gamma+1/8)}{1(1+m)^3} + \bar{K} \right] \left[1-s_2 \right]$$

$$\bar{v}_5 = \left[\frac{2m(\gamma+1/8)^2}{1^2(1+m)^4} + \frac{2m}{192 \cdot 1^2(1+m)^3} \right] s_3 \quad (39)$$

$$\bar{v}_6 = - \left[\frac{2m(\gamma+1/8)^2}{1^2(1+m)^4} + \frac{2m}{192 \cdot 1^2(1+m)^3} + \bar{K} \right] s_4 \quad (40)$$

$$\bar{v}_7 = \left[\left(\frac{m}{1+m} \right)^2 + \frac{2m(\gamma+1/8)}{1(1+m)^3} + \bar{K} \right] s_2 \quad (41)$$

$$\bar{P}_n = \frac{1}{\bar{v}_3} \left\{ -\frac{2\bar{w}_1}{1(1+m)} \frac{\gamma+1/8}{1+m} \bar{L}_n - \frac{2\bar{w}_1}{1^2(1+m)} \frac{\gamma+1/8}{1+m} \frac{\bar{L}_n}{\sigma_n^*} + \left[\frac{2m(\gamma+1/8)^2}{1^2(1+m)^4} + \frac{2m}{192 \cdot 1^2(1+m)^3} \right] \left[1-s_3 \right] g_n - \frac{2(\bar{w}_3 + \bar{w}_4)}{1(1+m)} \frac{\gamma+1/8}{1+m} \bar{L}_n \right\} = \quad (42)$$

$$= \frac{\bar{L}_n}{\bar{v}_3} \left[-\frac{2(\bar{w}_1 + \bar{w}_3 + \bar{w}_4)(\gamma + 1/8)}{1(1+m)^2} - \frac{2\bar{w}_1(\gamma + 1/8)}{1^2(1+m)^2} \frac{1}{\sigma_n^*} + \frac{2m(\gamma + 1/8)^2}{1^2(1+m)^4} \sum_{\substack{k=1 \\ k \neq n}}^{k=\infty} \frac{\sigma_k^*}{\sigma_n^*} \bar{L}_k \frac{1 + \frac{\sigma_n^*}{\sigma_k^*}}{1 - \frac{\sigma_n^*}{\sigma_k^*}} \right] = \quad (42)$$

$$= 2 \frac{\bar{L}_n}{\bar{v}_3} \frac{\gamma + 1/8}{1(1+m)^2} \left[-1 + \frac{\gamma + 1/8}{1(1+m)^2} - \frac{1}{\sigma_n^* 1(1+m)} + \frac{m(\gamma + 1/8)}{1(1+m)^2} \sum_{\substack{k=1 \\ k \neq n}}^{k=\infty} \frac{\sigma_k^*}{\sigma_n^*} \bar{L}_k \frac{1 + \frac{\sigma_n^*}{\sigma_k^*}}{1 - \frac{\sigma_n^*}{\sigma_k^*}} \right]$$

$$\bar{P}'_n = \frac{1}{\bar{v}_4} \left\{ + \frac{2\bar{w}_1}{1^2(1+m)} \frac{\gamma + 1/8}{1+m} \frac{\bar{L}_n}{\sigma_n^*} + \frac{2(\bar{w}_3 + \bar{w}_4)}{1(1+m)} \frac{\gamma + 1/8}{1+m} \bar{L}_n - \left[\frac{2m(\gamma + 1/8)^2}{1^2(1+m)^4} + \frac{2m}{192 \cdot 1^2(1+m)^3} + \bar{K} \right] \left[1 - S_4 \right] c_n + \quad (43)$$

$$+ \left[\frac{m^2}{(1+m)^2} + \frac{2m(\gamma + 1/8)}{1(1+m)^3} + \bar{K} \right] \left[1 - S_2 \right] e_n \left\} = \frac{1}{\bar{v}_4} \left\{ \frac{2\bar{w}_1(\gamma + 1/8) \bar{L}_n}{1^2(1+m)^2 \sigma_n^*} + \frac{2(\bar{w}_3 + \bar{w}_4)(\gamma + 1/8)}{1(1+m)^2} \bar{L}_n - \right.$$

$$\left. - \frac{\gamma + 1/8}{1+m} \frac{2}{1(1+m)} \left[\frac{m(\gamma + 1/8)}{1(1+m)^2} + \frac{m^2}{1+m} (1 - \bar{S}_1) \right] \sum_{\substack{k=1 \\ k \neq n}}^{k=\infty} \frac{\frac{\sigma_n^*}{\sigma_k^*} \bar{L}_n \bar{L}'_k + \frac{\sigma_k^*}{\sigma_n^*} \bar{L}'_n \bar{L}_k}{1 - \frac{\sigma_n^*}{\sigma_k^*}} + \right.$$

$$\left. + \frac{\gamma + 1/8}{1+m} \frac{2\bar{w}_4}{1(1+m)} \bar{L}_n \sigma_n^* \sum_{k=1}^{k=\infty} \bar{C}_k (\bar{A}_k - \bar{G}_k) \frac{1 - \frac{\bar{B}_k}{\bar{A}_k - \bar{G}_k} \frac{\sigma_n^*}{\sigma_k^*}}{1 - \bar{A}_k \frac{\sigma_n^*}{\sigma_k^*} + \bar{B}_k (\frac{\sigma_n^*}{\sigma_k^*})^2} \right\} =$$

$$= 2 \frac{\bar{L}_n}{\bar{v}_4} \frac{\gamma+1/8}{1(1+m)^2} \left\{ \bar{w}_4 \left[1 + \sigma_n^* \sum_{k=1}^{k=\infty} \bar{C}_k (\bar{A}_k - \bar{G}_k) \frac{1 - \frac{\bar{B}_k}{\bar{A}_k - \bar{G}_k} \sigma_n^*}{1 - \bar{A}_k \sigma_n^* + \bar{B}_k (\sigma_n^*)^2} \right] + \bar{w}_3 \left[1 + \sum_{\substack{k=1 \\ k \neq n}}^{k=\infty} \frac{\frac{\sigma_n^*}{\sigma_k^*} \bar{L}_k + \frac{\sigma_k^*}{\sigma_n^*} \frac{\bar{L}'_n L_k}{L_n}}{1 - \sigma_n^* / \sigma_k^*} \right] + \frac{\bar{w}_1}{16_n^*} \right\} \quad (43)$$

$$\bar{Q}_n = \frac{\bar{L}_n^2}{\sum_{n=1}^{n=\infty} \bar{L}_n^2} \quad (44)$$

$$\bar{Q}'_n = \frac{\bar{L}_n \bar{L}'_n}{\sum_{n=1}^{n=\infty} \bar{L}_n \bar{L}'_n} \quad (45)$$

From eq. 1 we get:

$$\lim_{\sigma \rightarrow \infty} \bar{V}(\sigma) = \lim_{\sigma \rightarrow \infty} \frac{2}{1\gamma\sigma^2} \quad (46)$$

From eq. (34) we get:

$$\lim_{\sigma \rightarrow \infty} \bar{V}(\sigma) = \lim_{\sigma \rightarrow \infty} \left[\frac{\bar{v}_1}{\sigma} - \frac{2\bar{v}_2}{1^2\sigma^2} + \frac{2\bar{v}_2}{1\sigma} + \frac{\bar{v}_3}{\sigma} \sum_{n=1}^{n=\infty} \bar{P}_n \sigma_n^* - \frac{\bar{v}_3}{\sigma^2} \sum_{n=1}^{n=\infty} \bar{P}_n (\sigma_n^*)^2 + \frac{\bar{v}_5}{\sigma^2} \sum_{n=1}^{n=\infty} \bar{Q}_n (\sigma_n^*)^2 \right] \quad (47)$$

Comparing (47) to (46), it must be

$$\bar{v}_1 + \frac{2\bar{v}_2}{1} + \bar{v}_3 \sum_{n=1}^{n=\infty} \bar{P}_n \sigma_n^* = 0 \quad (48)$$

and

$$\bar{v}_5 \sum_{n=1}^{n=\infty} \bar{Q}_n (\sigma_n^*)^2 - \bar{v}_3 \sum_{n=1}^{n=\infty} \bar{P}_n (\sigma_n^*)^2 - \frac{2\bar{v}_2}{1^2} = \frac{2}{1\gamma} \quad (49)$$

It is:

$$\bar{v}_1 + \bar{v}_2 + \bar{v}_3 + \bar{v}_4 + \bar{v}_5 + \bar{v}_6 + \bar{v}_7 = 1 \quad (50)$$

and

$$\sum_{n=1}^{n=\infty} \bar{p}_n = \sum_{n=1}^{n=\infty} \bar{p}'_n = \sum_{n=1}^{n=\infty} Q_n = \sum_{n=1}^{n=\infty} Q'_n = \sum_{n=1}^{n=\infty} \bar{z}_n = 1 \quad (51)$$

Appendix 8

In this appendix we want to develop the following expressions:

$$\frac{\mathcal{L}^2 F_s(\sigma)}{\mathcal{L}^2 + Y^2(\sigma)} = \sum_{n=1}^{n=\infty} DS_n \frac{1 + ES_n \sigma}{1 + AS_n \sigma + BS_n \sigma^2} \quad (1)$$

$$\frac{Y(\sigma) F_s(\sigma)}{\mathcal{L}^2 + Y^2(\sigma)} = \sum_{n=1}^{n=\infty} DZ_n \frac{1 + EZ_n \sigma}{1 + AS_n \sigma + BS_n \sigma^2} \quad (2)$$

where " $-\sigma_n^0$ " and " $-\bar{\sigma}_n^0$ " are the complex conjugate roots of the equation

$$1 + AS_n \sigma + BS_n \sigma^2 = 0 \quad (3)$$

" $-\sigma_n^0$ " are the roots of the equation

$$Y(\sigma) = j\alpha \quad (4)$$

and " $-\bar{\sigma}_n^0$ " solve the conjugate equation

$$Y(\sigma) = -j\alpha \quad (5)$$

In Appendix 9 it will be described the procedure to evaluate the roots " $-\sigma_n^0$ ".

From (3) we have

$$AS_n = \frac{\sigma_n^0 + \bar{\sigma}_n^0}{\sigma_n^0 \bar{\sigma}_n^0} \quad (6)$$

$$BS_n = \frac{1}{\sigma_n^0 \bar{\sigma}_n^0} \quad (7)$$

Now we want to determine the coefficients DS_n , ES_n , DZ_n and EZ_n .

From eq. (1) we have for $\sigma \rightarrow -\sigma_n^0$

$$DS_n (1 - ES_n \sigma_n^0) = \lim_{\sigma \rightarrow -\sigma_n^0} \frac{\mathcal{L}^2 F_s(\sigma) (1 + AS_n \sigma + BS_n \sigma^2)}{\mathcal{L}^2 + Y^2(\sigma)} \quad (8)$$

With the definitions of $F_s(\sigma)$, $Y(\sigma)$ and $Z(\sigma)$ in para 2 and according to l'Hospital's theorem we get

$$\lim_{\sigma \rightarrow -\sigma_n^0} \frac{\alpha^2 F_s(\sigma) (1 + AS_n \sigma + BS_n \sigma^2)}{\alpha^2 + Y^2(\sigma)} = \frac{\alpha^2 (AS_n - 2BS_n \sigma_n^0)}{-2 \left[\mu + Z(-\sigma_n^0) \right] Y(-\sigma_n^0) \left\{ l\sigma_n^0 + \frac{lm}{4 \left[\mu + Z(-\sigma_n^0) \right]^2} + \frac{lm \sigma_n^0 Z^2(-\sigma_n^0)}{\left[\mu + Z(-\sigma_n^0) \right]^2} \right\}} \quad (9)$$

From (4) we have

$$Y(-\sigma_n^0) = j\alpha \quad (10)$$

$$\frac{1}{\mu + Z(-\sigma_n^0)} = \frac{1}{m} \left(\frac{j\alpha}{l} + \sigma_n^0 \right) \quad (11)$$

$$\frac{Z(-\sigma_n^0)}{\mu + Z(-\sigma_n^0)} = 1 - \frac{\mu}{m} \left(\frac{j\alpha}{l} + \sigma_n^0 \right) \quad (12)$$

If we write the limit as $R_n + jI_n$, it is

$$R_n + jI_n = \frac{\alpha (\sigma_n^0 - \bar{\sigma}_n^0) \left(\frac{j\alpha}{l} + \sigma_n^0 \right)}{2mj \sigma_n^0 \bar{\sigma}_n^0 \left\{ l\sigma_n^0 + \frac{l}{4m} \left(\frac{j\alpha}{l} + \sigma_n^0 \right)^2 + lm \sigma_n^0 \left[1 - \frac{\mu}{m} \left(\frac{j\alpha}{l} + \sigma_n^0 \right) \right]^2 \right\}} \quad (13)$$

From eq. (1) we have for $\sigma \rightarrow -\bar{\sigma}_n^0$

$$DS_n (1 - ES_n \bar{\sigma}_n^0) = \lim_{\sigma \rightarrow \bar{\sigma}_n^0} \frac{\alpha^2 F_s(\sigma) (1 + AS_n \sigma + BS_n \sigma^2)}{\alpha^2 + Y^2(\sigma)} \quad (14)$$

According to the relation

$$f(\bar{z}) = \overline{f(z)} \quad (15)$$

where f is an analytical function and z is a complex variable, in eq. (14) the

limit is $R_n - jI_n$.

Eqs. (8) and (14) can be written as follows

$$DS_n (1 - ES_n \sigma_n^0) = R_n + jI_n \quad (16)$$

$$DS_n (1 - ES_n \bar{\sigma}_n^0) = R_n - jI_n \quad (17)$$

Putting

$$\sigma_n^0 = \mu_n^0 - j\nu_n^0 \quad (18)$$

$$\bar{\sigma}_n^0 = \mu_n^0 + j\nu_n^0 \quad (19)$$

we get

$$DS_n = R_n + \frac{\mu_n^0}{\nu_n^0} I_n \quad (20)$$

$$ES_n = \frac{I_n}{\nu_n^0} \frac{1}{R_n + \frac{\mu_n^0}{\nu_n^0} I_n} \quad (21)$$

From eq. (2) we have for $\sigma \rightarrow -\sigma_n^0$

$$DZ_n (1 - EZ_n \sigma_n^0) = \lim_{\sigma \rightarrow -\sigma_n^0} \frac{Y(\sigma) F_s(\sigma) (1 + AS_n \sigma + BS_n \sigma^2)}{\alpha^2 + Y^2(\sigma)} \quad (22)$$

$$DZ_n (1 - EZ_n \sigma_n^0) = \frac{j}{\alpha} (R_n + jI_n) \quad (23)$$

and for $\sigma \rightarrow -\bar{\sigma}_n^0$

$$DZ_n (1 - EZ_n \bar{\sigma}_n^0) = -\frac{j}{\alpha} (R_n - jI_n) \quad (24)$$

with $R_n + jI_n$ from eq. (13).

From (23) and (24) we get

$$DZ_n = -\frac{1}{\alpha} \left(I_n - \frac{\mu_n^0}{\nu_n^0} R_n \right) \quad (25)$$

$$EZ_n = -\frac{R_n}{\nu_n^0} \frac{1}{I_n - \frac{\mu_n^0}{\nu_n^0} R_n} \quad (26)$$

From eqs. (1) and (2) we have for $\sigma \rightarrow 0$

$$\lim_{\sigma \rightarrow 0} \frac{\alpha^2 F_s(\sigma)}{\alpha^2 + Y^2(\sigma)} = 1 = \sum_{n=1}^{n=\infty} DS_n \quad (27)$$

and

$$\lim_{\sigma \rightarrow 0} \frac{Y(\sigma) F_s(\sigma)}{\alpha^2 + Y^2(\sigma)} = 0 = \sum_{n=1}^{n=\infty} DZ_n \quad (28)$$

Appendix 9

In this appendix we want to solve the following Bessel function equation in the complex domain:

$$k^2 \alpha^2 + Y^2(\sigma) = 0 \quad (1)$$

where

$$Y(\sigma) = \ell\sigma + \frac{\ell m}{\gamma + Z(\sigma)} \quad (2)$$

$$Z(\sigma) = -\frac{J_0(\sqrt{-\sigma})}{2\sqrt{-\sigma} J_1(\sqrt{-\sigma})} = \frac{d}{d\sigma} \ln(\sqrt{-\sigma} J_1(\sqrt{-\sigma})) \quad (3)$$

σ being complex variable $\sigma = \mu + i\nu$; ℓ , m , γ , α being parameters and J_0 and J_1 being Bessel functions of the first kind. k has the value 1 in the appendix 8, and the value 2 in the appendix 12.

Eq. (1) can be transformed into

$$Y(\sigma) = \pm j k \alpha \quad (4)$$

The roots of eq. (4) are complex conjugate. We consider eq. (4) with the plus, that is the roots having positive imaginary part.

We define the function $f(\sigma)$

$$f(\sigma) = \sigma - ja + \frac{m}{\gamma + Z(\sigma)} \quad (5)$$

with

$$a = \frac{k\alpha}{\ell} \quad (6)$$

Note that only the three parameters a , γ , m appear in the expression of $f(\sigma)$.

Eq. (4) with the plus can be written as

$$f(\sigma) = \sigma - ja + \frac{m}{\gamma + Z(\sigma)} = 0 \quad (7)$$

Let us now introduce the two auxiliary equations

$$\sigma + \frac{m}{\gamma + Z(\sigma)} = 0 \quad (8)$$

and

$$\sigma - ja + \frac{m}{\gamma + 1/\sigma} = 0 \quad (9)$$

which are obtained from eq. 7 by putting respectively

$$a = 0 \quad (10)$$

and

$$Z(\sigma) = \frac{1}{\sigma} \quad (\text{lumped model}) \quad (11)$$

Eq. 8 has already been solved in Appendix 4. The roots are real and they are indicated with $-\sigma_n^*$.

Eq. 9 gives two roots which we indicate with σ_C and σ_D .

Eq. 7 is solved by finding those values of σ which make the modulus of $f(\sigma)$ equal to zero.

This is obtained by calculating the modulus of $f(\sigma)$ for successive values of σ which are obtained by making alternatively steps of the real part " μ " and of the imaginary part " ν " in the direction in which the modulus of $f(\sigma)$ tends to decrease. This process is carried out until either the modulus of $f(\sigma)$ or the step widths of " μ " and " ν " become smaller than given values.

The initial values which are used in this process are the real roots of eq. 3 ($-\sigma_n^*$) and the two roots of eq. 9 (σ_C and σ_D).

It has been always observed that one of the initial values $-\sigma_n^*$ leads to a root of eq. 7 which is equal to one of the two roots of eq. 7 obtained by using σ_C and σ_D as initial values. This means that one root has been calculated twice.

The remaining root (between those two which are obtained from σ_C and σ_D) is called "singular pole" and its influence on the coolant transients can be observed in figs. 17 and 18. The "singular pole" has usually a big imaginary part.

To understand why the process here described gives always a root which is calculated twice, let us consider, the approximated expression of $Z(\sigma)$ given in appendix 4 (with only N poles)

$$Z(\sigma) \approx \frac{1}{\sigma} + \sum_{n=2}^N \frac{1}{\sigma + b_n} \quad (12)$$

Putting 12 in 7 we get

$$f(\sigma) \approx \sigma - ja + \frac{m}{\gamma + \frac{1}{\sigma} + \sum_{n=2}^N \frac{1}{\sigma + b_n}} = 0 \quad (13)$$

The two auxiliary equations (8) and (9) become respectively

$$\sigma + \frac{m}{\gamma + \frac{1}{\sigma} + \sum_{n=2}^N \frac{1}{\sigma + b_n}} = 0 \quad (14)$$

and

$$\sigma - ja + \frac{m}{\gamma + \frac{1}{\sigma}} = 0 \quad (15)$$

which are obtained from eq. (13) by putting respectively

$$a = 0 \quad (16)$$

and

$$b_2 = b_3 = \dots = b_N = \infty \quad (17)$$

Now we observe that eq. (13) has $N+1$ roots while eqs. (14) and (15) have respectively " N " and 2 roots.

The $N+2$ initial values will lead to $N+2$ roots of eq. (13). Since eq. (13) has only $N+1$ roots, it means that a root has been calculated twice.

Fig. 23 shows the flow chart of the procedure to search the roots of eq. (7). μ, ν are the roots; μ_A, ν_A are approximate values of the roots; $\Delta\mu$ and $\Delta\nu$ are the widths of the steps respectively in μ - and ν -direction. The modulus of $f(\sigma)$ at $\sigma = \mu + i\nu$ is $F(\mu, \nu)$, which is calculated by another subroutine.

The found roots are successively arranged in correspondence to the amount of their real part and the roots which are equal are listed only one time.

Appendix 10

In this appendix we want to obtain the expression (2) of para 7.1.

We start from

$$V(\sigma, x) = \frac{\alpha}{\sin(\alpha x) + \sin(\alpha/2)} \left[\frac{F_3(\sigma) Y(\sigma)}{\alpha^2 + Y^2(\sigma)} \left(\cos(\alpha x) - \cos(\alpha/2) e^{-(x+1/2) Y(\sigma)} \right) + \frac{F_5(\sigma) \alpha^2}{\alpha^2 + Y^2(\sigma)} \left(\frac{\sin(\alpha x)}{\alpha} + \frac{\sin(\alpha/2)}{\alpha} e^{-(x+1/2) Y(\sigma)} \right) \right] \quad (1)$$

According to the eqs. (1) and (2) of para 4 and eqs. (1) and (2) of appendix 8 eq. (1) can be written as

$$V(\sigma, x) = \frac{\alpha}{\sin(\alpha x) + \sin(\alpha/2)} \left\{ \cos(\alpha x) \sum_{n=1}^{\infty} DZ_n \frac{1+EZ_n\sigma}{1+A_n\sigma+B_n\sigma^2} + \frac{\sin(\alpha x)}{\alpha} \sum_{n=1}^{\infty} DS_n \frac{1+ES_n\sigma}{1+A_n\sigma+B_n\sigma^2} + \frac{\sin(\alpha/2)}{\alpha} \left[\sum_{n=1}^{\infty} \frac{DP_n+EP_n\sigma}{1+A_n\sigma+B_n\sigma^2} \right] \left[W_1 + (1-W_1) \sum_{n=1}^{\infty} D_n \frac{1+E_n\sigma}{1+A_n\sigma+B_n\sigma^2} \right] e^{-(x+1/2)l\sigma} \right\} \quad (2)$$

where

$$DP_n = DS_n - \frac{\alpha \cos(\alpha/2)}{\sin(\alpha/2)} DZ_n \quad (3)$$

$$EP_n = DS_n ES_n - \frac{\alpha \cos(\alpha/2)}{\sin(\alpha/2)} DZ_n EZ_n \quad (4)$$

$$\sum_{n=1}^{\infty} DP_n = 1 \quad (5)$$

$$\sum_{n=1}^{\infty} \frac{DP_n+EP_n\sigma}{1+A_n\sigma+B_n\sigma^2} = \frac{F_5(\sigma)\alpha^2 - \frac{\alpha \cos(\alpha/2)}{\sin(\alpha/2)} F_3(\sigma) Y(\sigma)}{\alpha^2 + Y^2(\sigma)} \quad (6)$$

It is

$$\left[\sum_{n=1}^{\infty} \frac{DP_n+EP_n\sigma}{1+A_n\sigma+B_n\sigma^2} \right] \left[\sum_{n=1}^{\infty} D_n \frac{1+E_n\sigma}{1+A_n\sigma+B_n\sigma^2} \right] = S_2 \sum_{n=1}^{\infty} \frac{DK_1+EK_1\sigma}{1+A_n\sigma+B_n\sigma^2} + (1-S_2) \sum_{n=1}^{\infty} \frac{DK_2+EK_2\sigma}{1+A_n\sigma+B_n\sigma^2} \quad (7)$$

with

$$\sum_{n=1}^{n=\infty} DK1_n = \sum_{n=1}^{n=\infty} DK2_n = 1 \quad (8)$$

The complex conjugate roots of the equation

$$1 + A_n \sigma + B_n \sigma^2 = 0 \quad (9)$$

are $-\sigma'_n$ and $-\bar{\sigma}'_n$ and those of the equation

$$1 + A_n^0 \sigma + B_n^0 \sigma^2 = 0 \quad (10)$$

are $-\sigma_n^0$ and $-\bar{\sigma}_n^0$.

Putting

$$R1_n + jI1_n = D_n (1 - E_n \sigma'_n) \frac{\alpha^2 F_s(-\sigma'_n) - \frac{\alpha \cos(k/2)}{\sin(\alpha/2)} F_s(-\sigma'_n) Y(-\sigma'_n)}{\alpha^2 + Y^2(-\sigma'_n)} \quad (11)$$

and

$$R2_n + jI2_n = (D_n^0 - E_n^0 \sigma_n^0) \sum_{k=1}^{k=\infty} D_k \frac{1 - E_k \sigma_n^0}{1 - A_k \sigma_n^0 + B_k (\sigma_n^0)^2} \quad (12)$$

from eq. (11) we get

$$DK1_n - EK1_n \sigma'_n = \frac{1}{S_2} (R1_n + jI1_n) \quad (13)$$

$$DK1_n - EK1_n \bar{\sigma}'_n = \frac{1}{S_2} (R1_n - jI1_n) \quad (14)$$

$$DK2_n - EK2_n \sigma_n^0 = \frac{1}{1 - S_2} (R2_n + jI2_n) \quad (15)$$

$$DK2_n - EK2_n \bar{\sigma}_n^0 = \frac{1}{1 - S_2} (R2_n - jI2_n) \quad (16)$$

Putting

$$\sigma'_n = \mu_n - j\nu_n \quad (17)$$

and

$$\sigma_n^0 = \mu_n^0 - j\nu_n^0 \quad (18)$$

from eqs. (13) and (14) respectively from eqs. (15) and (16) we obtain

$$DK1_n = \frac{1}{S_2} \left(R1_n + \frac{\mu_n}{\nu_n} I1_n \right) \quad (19)$$

$$EK1_n = \frac{1}{S_2} \frac{I1_n}{v_n} \quad (20)$$

$$DK2_n = \frac{1}{1-S_2} \left(R2_n + \frac{\mu_n^0}{v_n^0} I2_n \right) \quad (21)$$

$$EK2_n = \frac{1}{1-S_2} \frac{I2_n}{v_n^0} \quad (22)$$

Since it is

$$\sum_{n=1}^{n=\infty} DK1_n = \sum_{n=1}^{n=\infty} DK2_n = 1 \quad (23)$$

we get

$$S_2 = \sum_{n=1}^{n=\infty} \left(R1_n + \frac{\mu_n}{v_n} I1_n \right) \quad (24)$$

and

$$1-S_2 = \sum_{n=1}^{n=\infty} \left(R2_n + \frac{\mu_n^0}{v_n^0} I2_n \right) \quad (25)$$

Combining eqs. (2) and (17), we get finally

$$V(\sigma, x) = v_1 \sum_{n=1}^{n=\infty} D1_n \frac{1+E1_n\sigma}{1+A_n\sigma+B_n\sigma^2} + v_2 e^{-(x+1/2)\ell\sigma} \sum_{n=1}^{n=\infty} D2_n \frac{1+E2_n\sigma}{1+A_n\sigma+B_n\sigma^2} + v_3 e^{-(x+1/2)\ell\sigma} \sum_{n=1}^{n=\infty} D3_n \frac{1+E3_n\sigma}{1+A_n\sigma+B_n\sigma^2} \quad (26)$$

where

$$v_1 = \frac{1}{\sin(\alpha x) + \sin(\alpha/2)} \quad (27)$$

$$v_2 = \frac{\sin(\alpha/2)}{\sin(\alpha x) + \sin(\alpha/2)} \left[w_1 + (1-w_1)(1-S_2) \right] \quad (28)$$

$$v_3 = \frac{\sin(\alpha/2)}{\sin(\alpha x) + \sin(\alpha/2)} (1-w_1) S_2 \quad (29)$$

$$D1_n = \sin(\alpha x) DS_n + \alpha \cos(\alpha x) DZ_n \quad (30)$$

$$E1_n = \frac{1}{D1_n} \left(\sin(\alpha x) DS_n ES_n + \alpha \cos(\alpha x) DZ_n EZ_n \right) \quad (31)$$

$$D2_n = \frac{w_1 DP_n + (1-w_1)(1-S_2) DK2_n}{w_1 + (1-w_1)(1-S_2)} \quad (32)$$

$$E2_n = \frac{w_1 EP_n + (1-w_1)(1-S_2)EK2_n}{w_1 DP_n + (1-w_1)(1-S_2)DK2_n} \quad (33)$$

$$D3_n = DK1_n \quad (34)$$

$$E3_n = \frac{EK1_n}{DK1_n} \quad (35)$$

It is

$$V_1 + V_2 + V_3 = 1 \quad (36)$$

$$\sum_{n=1}^{\infty} D1_n = \sum_{n=1}^{\infty} D2_n = \sum_{n=1}^{\infty} D3_n = 1 \quad (37)$$

By the way it is

$$\lim_{\sigma \rightarrow \infty} F_s(\sigma) = \lim_{\sigma \rightarrow \infty} \frac{1}{\sigma^2} \quad (38)$$

$$\lim_{\sigma \rightarrow \infty} Y(\sigma) = \lim_{\sigma \rightarrow \infty} \ell \sigma \quad (39)$$

With eqs. (38) and (39) from eq. (1) we get

$$\lim_{\sigma \rightarrow \infty} V(\sigma, x) = \lim_{\sigma \rightarrow \infty} \frac{\alpha \cos(\alpha x)}{\sin(\alpha x) + \sin(\alpha/2)} \frac{1}{\ell \sigma^2} \quad (40)$$

From eq. (26) we get

$$\lim_{\sigma \rightarrow \infty} V(\sigma, x) = \lim_{\sigma \rightarrow \infty} v_1 \left\{ \frac{1}{\sigma} \sum_{n=1}^{\infty} \frac{D1_n E1_n}{BS_n} + \frac{1}{\sigma^2} \sum_{n=1}^{\infty} \frac{D1_n}{BS_n} \left(1 - \frac{AS_n E1_n}{BS_n} \right) \right\} \quad (41)$$

Comparing (40) to (41), we get

$$\sum_{n=1}^{\infty} \frac{D1_n E1_n}{BS_n} = 0 \quad (42)$$

$$\sum_{n=1}^{\infty} \frac{D1_n}{BS_n} \left(1 - \frac{AS_n E1_n}{BS_n} \right) = \alpha \cos(\alpha x) \frac{1}{\ell} \quad (43)$$

Appendix 11

In this appendix we want to obtain the expression (2) of para 7.2.

We start from

$$\bar{V}(\sigma) = \frac{2F_5(\sigma)Y(\sigma)}{d^2 + Y^2(\sigma)} \left[1 - \frac{1 - a^{-Y(\sigma)}}{Y(\sigma)} \frac{(d/2) \cos(d/2)}{\sin(d/2)} \right] + \frac{F_5(\sigma)d^2}{d^2 + Y^2(\sigma)} \frac{1 - a^{-Y(\sigma)}}{Y(\sigma)} \tag{1}$$

According to the eqs. (1) and (2) of para 6 and eqs. (1) and (2) of appendix 8 eq. (1) can be written as

$$\begin{aligned} \bar{V}(\sigma) = & 2 \sum_{n=1}^{\infty} DZ_n \frac{1 + EZ_n \sigma}{1 + AS_n \sigma + BS_n \sigma^2} + \left[\bar{W}_1 \frac{1 - a^{-l\sigma}}{l\sigma} + \bar{W}_2 \sum_{n=1}^{\infty} \frac{\bar{L}_n}{1 + \sigma/\sigma_n^*} \right. \\ & + \bar{W}_3 a^{-l\sigma} \sum_{n=1}^{\infty} \frac{\bar{L}'_n}{1 + \sigma/\sigma_n^*} + \bar{W}_4 a^{-l\sigma} \sum_{n=1}^{\infty} \frac{\bar{C}_n (1 + \bar{G}_n \sigma)}{1 + \bar{A}_n \sigma + \bar{B}_n \sigma^2} \left. \right] \\ & \times \left[\sum_{n=1}^{\infty} \frac{DK_n + EK_n \sigma}{1 + AS_n \sigma + BS_n \sigma^2} \right] \end{aligned} \tag{2}$$

where

$$DK_n = DS_n - \frac{d \cos(d/2)}{\sin(d/2)} DZ_n$$

$$EK_n = DS_n ES_n - \frac{d \cos(d/2)}{\sin(d/2)} DZ_n EZ_n$$

$$\sum_{n=1}^{\infty} DK_n = 1$$

and

$$\sum_{n=1}^{\infty} \frac{DK_n + EK_n \sigma}{1 + AS_n \sigma + BS_n \sigma^2} = \frac{d^2 F_5(\sigma) - \frac{d \cos(d/2)}{\sin(d/2)} F_5(\sigma) Y(\sigma)}{d^2 + Y^2(\sigma)} \tag{3}$$

It is

$$\frac{1-a^{-l\sigma}}{l\sigma} \left(\sum_{n=1}^{n=\infty} \frac{DK_n + EK_n\sigma}{1+AS_n\sigma + BS_n\sigma^2} \right) = \frac{1-a^{-l\sigma}}{l\sigma} - \frac{1-a^{-l\sigma}}{l} \sum_{n=1}^{n=\infty} \frac{DK_n AS_n - EK_n + DK_n BS_n\sigma}{1+AS_n\sigma + BS_n\sigma^2} \quad (7)$$

$$\begin{aligned} \sum_{n=1}^{n=\infty} (DK_n AS_n - EK_n) &= \lim_{\sigma \rightarrow 0} \left(\frac{1}{\sigma} - \frac{1}{\sigma} \frac{\alpha^2 F'_s(\sigma) - \frac{\alpha \cos(\alpha/2)}{\sin(\alpha/2)} F_s(\sigma) Y(\sigma)}{\alpha^2 + Y^2(\sigma)} \right) \\ &= \lim_{\sigma \rightarrow 0} \frac{2Y(\sigma)Y'(\sigma) - \alpha^2 F'_s(\sigma) + \frac{\alpha \cos(\alpha/2)}{\sin(\alpha/2)} (F'_s(\sigma)Y(\sigma) + F_s(\sigma)Y'(\sigma))}{\alpha^2 + Y^2(\sigma) + 2\sigma Y(\sigma)Y'(\sigma)} \end{aligned} \quad (8)$$

Taking into account eqs. (15) and (16) of appendix 5 and the equations

$$Y(0) = 0 \quad (9)$$

$$Y'(0) = l(1+m) \quad (10)$$

we get

$$\sum_{n=1}^{n=\infty} (DK_n AS_n - EK_n) = \mu + \gamma/l + \frac{\cos(\alpha/2)}{\alpha \sin(\alpha/2)} l(1+m) \quad (11)$$

From eq. (3) of appendix 5 and eq. (18) of appendix 7 we get

$$\frac{\mu + \gamma/l}{1+m} \sum_{n=1}^{n=\infty} \frac{\bar{L}_n}{1+\sigma/\sigma_n^*} = \frac{1}{\sigma} - \frac{1}{\sigma} \frac{(1+m)F_s(\sigma)}{1+mF_s(\sigma)} \quad (12')$$

and

$$\sum_{n=1}^{n=\infty} \frac{\bar{L}_n}{1+\sigma/\sigma_n^*} = \frac{l(1+m)}{\mu + \gamma/l} \frac{1-F_s(\sigma)}{Y(\sigma)} \quad (12)$$

From eq. (1) of appendix 4 we get

$$F_s(-\sigma_k^*) = -\frac{1}{m} \quad (13)$$

and

$$Y(-\sigma_k^*) = 0 \quad (14)$$

According to the equation (5), (6), (13) and (14) it is

$$\left[\sum_{n=1}^{n=\infty} \frac{\bar{L}_n}{1+\sigma/\sigma_n^*} \right] \left[\sum_{n=1}^{n=\infty} \frac{DK_n + EK_n \sigma}{1+AS_n \sigma + BS_n \sigma^2} \right] =$$

$$= \frac{1+m}{m} \sum_{n=1}^{n=\infty} \frac{DK_3_n + EK_3_n \sigma}{1+AS_n \sigma + BS_n \sigma^2} - \frac{1}{m} \sum_{n=1}^{n=\infty} \frac{\bar{L}_n}{1+\sigma/\sigma_n^*} \quad (15)$$

with

$$\sum_{n=1}^{n=\infty} DK_3_n = 1 \quad (16)$$

$-\sigma_n^0$ and $-\bar{\sigma}_n^0$ are the complex conjugate roots of the equation

$$1 + AS_n \sigma + BS_n \sigma^2 = 0 \quad (17)$$

Taking into account eq. (10) of appendix 8 we put

$$R_3_n + jI_3_n = (DK_n - EK_n \sigma_n^0) \left(\frac{\ell}{\mu + 1/s} \left(\frac{1+m}{j\ell} + \frac{1}{\ell \sigma_n^0} \right) \right) \quad (18)$$

and get

$$DK_3_n - EK_3_n \sigma_n^0 = R_3_n + jI_3_n \quad (19)$$

$$DK_3_n - EK_3_n \bar{\sigma}_n^0 = R_3_n - jI_3_n \quad (20)$$

Putting

$$\sigma_n^0 = \mu_n^0 - j\nu_n^0$$

from eqs. (19) and (20) we obtain

$$DK_3_n = R_3_n + \frac{\mu_n^0}{\nu_n^0} I_3_n \quad (21)$$

$$EK_3_n = \frac{I_3_n}{\nu_n^0} \quad (22)$$

According to the equations (5), (6), (13) and (14) it is

$$\left[\sum_{n=1}^{n=\infty} \frac{\bar{L}_n}{1+\sigma/\sigma_n^*} \right] \left[\sum_{n=1}^{n=\infty} \frac{DK_n + EK_n \sigma}{1+AS_n \sigma + BS_n \sigma^2} \right] = \frac{1+m}{m} \sum_{n=1}^{n=\infty} \frac{DK_4_n + EK_4_n \sigma}{1+AS_n \sigma + BS_n \sigma^2} - \frac{1}{m} \sum_{n=1}^{n=\infty} \frac{\bar{L}_n}{1+\sigma/\sigma_n^*} \quad (23)$$

with

$$\sum_{n=1}^{n=\infty} DK_4_n = 1 \quad (24)$$

Putting

$$R4_n + jI4_n = (DK_n - EK_n \sigma_n^0) \left(\sum_{k=1}^{k=\infty} \frac{\bar{L}_k}{1 - \sigma_n^0 / \sigma_k^+} \right) \quad (25)$$

we get

$$DK4_n - EK4_n \sigma_n^0 = \frac{m}{1+m} (R4_n + jI4_n) \quad (26)$$

$$DK4_n - EK4_n \bar{\sigma}_n^0 = \frac{m}{1+m} (R4_n - jI4_n) \quad (27)$$

$$DK4_n = \frac{m}{1+m} \left(R4_n + \frac{I4_n}{v_n^0} \mu_n^0 \right) \quad (28)$$

$$EK4_n = \frac{m}{1+m} \frac{I4_n}{v_n^0} \quad (29)$$

It is

$$\left(\sum_{n=1}^{n=\infty} \bar{C}_n \frac{1 + \bar{G}_n \sigma}{1 + \bar{A}_n \sigma + \bar{B}_n \sigma^2} \right) \left(\sum_{n=1}^{n=\infty} \frac{DK_n + EK_n \sigma}{1 + AS_n \sigma + BS_n \sigma^2} \right) =$$

$$= (1 - S_3) \sum_{n=1}^{n=\infty} \frac{DKS_n + EKS_n \sigma}{1 + AS_n \sigma + BS_n \sigma^2} + S_3 \sum_{n=1}^{n=\infty} \frac{DK6_n + EK6_n \sigma}{1 + \bar{A}_n \sigma + \bar{B}_n \sigma^2} \quad (30)$$

with

$$\sum_{n=1}^{n=\infty} DK5_n = \sum_{n=1}^{n=\infty} DK6_n = 1 \quad (31)$$

The complex conjugate roots of the equation

$$1 + \bar{A}_n \sigma + \bar{B}_n \sigma^2 = 0 \quad (32)$$

are $-\sigma_n^1$ and $-\bar{\sigma}_n^1$ and those of the equation

$$1 + AS_n \sigma + BS_n \sigma^2 = 0 \quad (33)$$

are $-\sigma_n^0$ and $-\bar{\sigma}_n^0$.

Putting

$$R5_n + jI5_n = (DK_n - EK_n \sigma_n^0) \left(\sum_{k=1}^{k=\infty} \bar{C}_k \frac{1 - \bar{G}_k \sigma_n^0}{1 - \bar{A}_k \sigma_n^0 + \bar{B}_k (\sigma_n^0)^2} \right) \quad (34)$$

and

$$R6_n + jI6_n = \bar{C}_n (1 - \bar{G}_n \sigma'_n) \frac{\mathcal{L}^2 F_s(-\sigma'_n) - \frac{\mathcal{L} \cos(\theta/2)}{\sin(\theta/2)} F_s(-\sigma'_n) Y(-\sigma'_n)}{\mathcal{L}^2 + Y^2(-\sigma'_n)} \quad (35)$$

from eq. (30) we get

$$DK5_n - EK5_n \sigma_n^0 = \frac{1}{1-s_3} (R5_n + jI5_n) \quad (36)$$

$$DK5_n - EK5_n \bar{\sigma}_n^0 = \frac{1}{1-s_3} (R5_n - jI5_n) \quad (37)$$

$$DK6_n - EK6_n \sigma'_n = \frac{1}{s_3} (R6_n + jI6_n) \quad (38)$$

$$DK6_n - EK6_n \bar{\sigma}'_n = \frac{1}{s_3} (R6_n - jI6_n) \quad (39)$$

Putting

$$\sigma'_n = \mu_n - j\nu_n \quad (40)$$

and

$$\sigma_n^0 = \mu_n^0 - j\nu_n^0 \quad (41)$$

from eqs. (36) and (37) respectively from eqs. (38) and (39) we obtain

$$DK5_n = \frac{1}{1-s_3} (R5_n + \frac{\mu_n^0}{\nu_n^0} I5_n) \quad (42)$$

$$EK5_n = \frac{1}{1-s_3} \frac{I5_n}{\nu_n^0} \quad (43)$$

$$DK6_n = \frac{1}{s_3} (R6_n + \frac{\mu_n}{\nu_n} I6_n) \quad (44)$$

$$EK6_n = \frac{1}{s_3} \frac{I6_n}{\nu_n} \quad (45)$$

Since it is

$$\sum_{n=1}^{n=\infty} DK5_n = \sum_{n=1}^{n=\infty} DK6_n = 1 \quad (46)$$

we get

$$S_3 = \sum_{n=1}^{n=\infty} \left(Rb_n + \frac{\mu_n}{\gamma_n} I b_n \right) \quad (47)$$

$$1 - S_3 = \sum_{n=1}^{n=\infty} \left(R\bar{b}_n + \frac{\mu_n^0}{\gamma_n^0} I \bar{b}_n \right) \quad (48)$$

Combining eqs. (2), (4), (15), (23) and (30) we get finally

$$\begin{aligned} \bar{V}(\sigma) = & \bar{V}_1 \frac{1 - a^{-l\sigma}}{l\sigma} + \bar{V}_2 \sum_{n=1}^{n=\infty} \frac{\bar{L}_n}{1 + \sigma/\sigma_n^*} + \bar{V}_3 a^{-l\sigma} \sum_{n=1}^{n=\infty} \frac{\bar{L}'_n}{1 + \sigma/\sigma_n^*} + \\ & + \bar{V}_4 \sum_{n=1}^{n=\infty} D4_n \frac{1 + E4_n \sigma}{1 + A_n \sigma + B_n \sigma^2} + \bar{V}_5 a^{-l\sigma} \sum_{n=1}^{n=\infty} D5_n \frac{1 + E5_n \sigma}{1 + A_n \sigma + B_n \sigma^2} + \\ & + \bar{V}_6 a^{-l\sigma} \sum_{n=1}^{n=\infty} D6_n \frac{1 + E6_n \sigma}{1 + \bar{A}_n \sigma + \bar{B}_n \sigma^2} \end{aligned} \quad (49)$$

where

$$\bar{V}_1 = \bar{W}_1 = \frac{1}{1+m} \quad (50)$$

$$\bar{V}_2 = -\frac{\bar{W}_2}{m} = -\frac{\mu + 1/8}{l(1+m)^2} \quad (51)$$

$$\bar{V}_3 = -\frac{\bar{W}_3}{m} = \frac{\mu + 1/8}{l(1+m)^2} + \frac{m}{1+m} (1 - \bar{S}_1) \quad (52)$$

$$\bar{V}_4 = -\frac{\cos(d/2)}{2 \sin(d/2)} \quad (53)$$

$$\bar{V}_5 = \frac{\cos(d/2)}{2 \sin(d/2)} - m(1 - \bar{S}_1) + (1 - S_3) \left(m - \frac{m^2}{1+m} \bar{S}_1 \right) \quad (54)$$

$$\bar{V}_6 = \left(m - \frac{m^2}{1+m} \bar{S}_1 \right) S_3 \quad (55)$$

$$D4_n = \frac{1}{\bar{V}_4} \left[2 DZ_n + \frac{\mu + 1/8}{l(1+m)} DK3_n - \frac{DK_n A_n - EK_n}{l(1+m)} \right] \quad (56)$$

$$E4_n = \frac{2DZ_nEZ_n + \frac{\mu+1/2}{\ell(1+m)}EK3_n - \frac{DK_nBS_n}{\ell(1+m)}}{2DZ_n + \frac{\mu+1/2}{\ell(1+m)}DK3_n - \frac{DK_nAS_n - EK_n}{\ell(1+m)}} \quad (57)$$

$$D5_n = \frac{1}{\bar{v}_5} \left[\frac{DK_nAS_n - EK_n}{\ell(1+m)} - \left(\frac{\mu+1/2}{\ell(1+m)} + m(1-\bar{s}_1) \right) DK4_n + \left(m - \frac{m^2}{1+m} \bar{s}_1 \right) (1-s_3) DK5_n \right] \quad (58)$$

$$E5_n = \frac{\frac{DK_nBS_n}{\ell(1+m)} - \left(\frac{\mu+1/2}{\ell(1+m)} + m(1-\bar{s}_1) \right) EK4_n + \left(m - \frac{m^2}{1+m} \bar{s}_1 \right) (1-s_3) EK5_n}{\frac{DK_nAS_n - EK_n}{\ell(1+m)} - \left(\frac{\mu+1/2}{\ell(1+m)} + m(1-\bar{s}_1) \right) DK4_n + \left(m - \frac{m^2}{1+m} \bar{s}_1 \right) (1-s_3) DK5_n} \quad (59)$$

$$D6_n = DK6_n \quad (60)$$

$$E6_n = \frac{EK6_n}{DK6_n} \quad (61)$$

It is

$$\sum_{i=1}^{i=6} \bar{v}_i = 1 \quad (62)$$

and

$$\sum_{n=1}^{n=\infty} D4_n = \sum_{n=1}^{n=\infty} D5_n = \sum_{n=1}^{n=\infty} D6_n = 1 \quad (63)$$

From aq. (1) we get

$$\lim_{\sigma \rightarrow \infty} \bar{v}(\sigma) = \lim_{\sigma \rightarrow \infty} \frac{2}{\ell \sigma^2} \quad (64)$$

From aq. (49) we get

$$\lim_{\sigma \rightarrow \infty} \bar{V}(\sigma) = \lim_{\sigma \rightarrow \infty} \left[\frac{\bar{v}_1}{\ell \sigma} + \bar{v}_2 \frac{1}{\sigma} \sum_{n=1}^{n=\infty} \bar{L}_n \sigma_n^* + \frac{\bar{v}_4}{\sigma} \sum_{n=1}^{n=\infty} \frac{D4_n E4_n}{BS_n} + \frac{\bar{v}_4}{\sigma^2} \sum_{n=1}^{n=\infty} \frac{D4_n}{BS_n} \left(1 - \frac{AS_n E4_n}{BS_n} \right) \right] \quad (65)$$

From eq. (14) of appendix 6 we get

$$\sum_{n=1}^{n=\infty} \bar{L}_n \sigma_n^* = \frac{1+m}{r+1/8} \quad (66)$$

It is

$$\frac{\bar{V}_1}{l} + \bar{V}_2 \sum_{n=1}^{n=\infty} \bar{L}_n \sigma_n^* = \frac{1}{l(1+m)} - \frac{1}{l(1+m)} = 0 \quad (67)$$

Now comparing (62) to (63), we get

$$\sum_{n=1}^{n=\infty} \frac{D4_n E4_n}{BS_n} = 0 \quad (68)$$

$$\sum_{n=1}^{n=\infty} \frac{D4_n}{BS_n} \left(1 - \frac{AS_n E4_n}{BS_n} \right) = - \frac{2L \sin(d/2)}{\cos(d/2) l r} \quad (69)$$

Appendix 12

In this appendix we want to develop the following expressions:

$$\frac{4\alpha^2}{4\alpha^2 + Y^2(\sigma)} = \sum_{n=1}^{\infty} DH_n \frac{1 + EH_n\sigma}{1 + AH_n\sigma + BH_n\sigma^2} \quad (1)$$

$$\frac{Y(\sigma)}{4\alpha^2 + Y^2(\sigma)} = \sum_{n=1}^{\infty} DN_n \frac{1 + EN_n\sigma}{1 + AH_n\sigma + BH_n\sigma^2} \quad (2)$$

with

$$\sum_{n=1}^{\infty} DH_n = 1 \quad (3)$$

and

$$\sum_{n=1}^{\infty} DN_n = 0 \quad (4)$$

" $-\sigma_n^a$ " and " $-\overline{\sigma_n^a}$ " are the complex conjugate roots of the equation

$$1 + AH_n\sigma + BH_n\sigma^2 = 0 \quad (5)$$

" $-\sigma_n^a$ " are the roots of the equation

$$Y(\sigma) = 2j\alpha \quad (6)$$

The solution of eq. (6) is given in appendix 9.

From (5) we have

$$AH_n = \frac{\sigma_n^a + \overline{\sigma_n^a}}{\sigma_n^a \overline{\sigma_n^a}} \quad (7)$$

$$BH_n = \frac{1}{\sigma_n^a \overline{\sigma_n^a}} \quad (8)$$

From eq. (1) we have for $\sigma \rightarrow -\sigma_n^a$

$$\begin{aligned} DH_n (1 - EH_n \sigma_n^a) &= \lim_{\sigma \rightarrow -\sigma_n^a} \frac{4\alpha^2 (1 + AH_n\sigma + BH_n\sigma^2)}{4\alpha^2 + Y^2(\sigma)} \\ &= \frac{4\alpha^2 (AH_n - 2BH_n\sigma_n^a)}{2Y(-\sigma_n^a) \left[l + \frac{ml}{4\sigma_n^a (\mu + Z(-\sigma_n^a))^2} + \frac{ml Z(-\sigma_n^a)^2}{(\mu + Z(-\sigma_n^a))^2} \right]} \end{aligned} \quad (9)$$

Now it is

$$Y(-\sigma_n^Q) = 2j\alpha \quad (10)$$

$$\frac{1}{\mu + Z(-\sigma_n^Q)} = \frac{1}{m} \left(\frac{2j\alpha}{l} + \sigma_n^Q \right) \quad (11)$$

$$\frac{Z(-\sigma_n^Q)}{\mu + Z(-\sigma_n^Q)} = 1 - \frac{\mu}{m} \left(\frac{2j\alpha}{l} + \sigma_n^Q \right) \quad (12)$$

Writing the limit as $RH_n + jIH_n$, it is

$$RH_n + jIH_n = \frac{\alpha(\bar{\sigma}_n^Q - \sigma_n^Q)}{j\bar{\sigma}_n^Q \left[l\sigma_n^Q + \frac{l}{4m} \left(\frac{2j\alpha}{l} + \sigma_n^Q \right)^2 + ml\sigma_n^Q \left[1 - \frac{\mu}{m} \left(\frac{2j\alpha}{l} + \sigma_n^Q \right) \right]^2 \right]} \quad (13)$$

From eq. (1) we have for $\sigma \rightarrow -\sigma_n^Q$ and $\sigma \rightarrow -\bar{\sigma}_n^Q$

$$DH_n (1 - EH_n \sigma_n^Q) = RH_n + jIH_n \quad (14)$$

$$DH_n (1 - EH_n \bar{\sigma}_n^Q) = RH_n - jIH_n \quad (15)$$

Putting

$$\sigma_n^Q = \mu_n^Q - j\nu_n^Q \quad (16)$$

$$\bar{\sigma}_n^Q = \mu_n^Q + j\nu_n^Q \quad (17)$$

we get

$$DH_n = RH_n + \frac{\mu_n^Q}{\nu_n^Q} IH_n \quad (18)$$

$$EH_n = \frac{IH_n}{\nu_n^Q} \frac{1}{RH_n + \frac{\mu_n^Q}{\nu_n^Q} IH_n} \quad (19)$$

From eq. (2) we have for $\sigma \rightarrow -\sigma_n^Q$

$$DN_n (1 - EN_n \sigma_n^Q) = \lim_{\sigma \rightarrow -\sigma_n^Q} \frac{Y(\sigma) (1 + AH_n \sigma + BH_n \sigma^2)}{4\alpha^2 + Y^2(\sigma)} \quad (20)$$

$$DN_n (1 - EN_n \sigma_n^Q) = \frac{j}{2L} (RH_n + jIH_n) \quad (21)$$

and for $\sigma \rightarrow -\overline{\sigma}_n^Q$

$$DN_n (1 - EN_n \overline{\sigma}_n^Q) = -\frac{j}{2L} (RH_n - jIH_n) \quad (22)$$

From eqs. (21) and (22) we get

$$DN_n = -\frac{1}{2L} \left(IH_n - \frac{\mu_n^Q}{v_n^Q} RH_n \right) \quad (23)$$

$$EN_n = -\frac{RH_n}{v_n^Q} \frac{1}{IH_n - \frac{\mu_n^Q}{v_n^Q} RH_n} \quad (24)$$

Appendix 13

In this appendix we want to obtain the expression (2) of para 7.3.

We start from

$$W_{\text{eff}}(\sigma) = \frac{2}{1 + \frac{\sin \alpha}{\alpha}} \left\{ \cos^2(\alpha/2) \frac{Y(\sigma)}{4\alpha^2 + Y^2(\sigma)} (1 - e^{-Y(\sigma)}) \right. \\ \left. + \frac{2\alpha^2}{4\alpha^2 + Y^2(\sigma)} \left(\frac{1 - e^{-Y(\sigma)}}{Y(\sigma)} + \frac{\sin \alpha}{\alpha} \frac{1 + e^{-Y(\sigma)}}{2} \right) \right\} \quad (1)$$

According to the eqs. (1) and (2) of para 4, the eqs. (1) and (2) of para 6 and eqs. (1) and (2) of appendix 12 eq. (1) can be written as

$$W_{\text{eff}}(\sigma) = \frac{2}{1 + \frac{\sin \alpha}{\alpha}} \left\{ \frac{\sin \alpha}{4\alpha} \sum_{n=1}^{\infty} \mathcal{D}H_n \frac{1 + EH_n \sigma}{1 + AH_n \sigma + BH_n \sigma^2} + \cos^2(\alpha/2) \sum_{n=1}^{\infty} \mathcal{D}N_n \frac{1 + EN_n \sigma}{1 + AH_n \sigma + BH_n \sigma^2} + \right. \\ \left. + \frac{1}{2} \left(\sum_{n=1}^{\infty} \mathcal{D}H_n \frac{1 + EH_n \sigma}{1 + AH_n \sigma + BH_n \sigma^2} \right) \left(\bar{W}_1 \frac{1 - e^{-\ell \sigma}}{\ell \sigma} + \bar{W}_2 \sum_{n=1}^{\infty} \frac{\bar{L}_n}{1 + \sigma/\sigma_n^*} + \bar{W}_3 e^{-\ell \sigma} \sum_{n=1}^{\infty} \frac{\bar{L}'_n}{1 + \sigma/\sigma_n^*} + \right. \right. \\ \left. \left. + \bar{W}_4 e^{-\ell \sigma} \sum_{n=1}^{\infty} \bar{C}_n \frac{1 + \bar{G}_n \sigma}{1 + \bar{A}_n \sigma + \bar{B}_n \sigma^2} \right) + \right. \\ \left. + \frac{\sin \alpha}{4\alpha} e^{-\ell \sigma} \left(\sum_{n=1}^{\infty} \frac{\mathcal{D}M_n + EM_n \sigma}{1 + AH_n \sigma + BH_n \sigma^2} \right) \left(W_1 + (1 - W_1) \sum_{n=1}^{\infty} \bar{D}_n \frac{1 + \bar{E}_n \sigma}{1 + \bar{A}_n \sigma + \bar{B}_n \sigma^2} \right) \right\} \quad (2)$$

where

$$\mathcal{D}M_n = \mathcal{D}H_n - \frac{4\alpha \cos^2(\alpha/2)}{\sin \alpha} \mathcal{D}N_n \quad (3)$$

$$EM_n = \mathcal{D}H_n EH_n - \frac{4\alpha \cos^2(\alpha/2)}{\sin \alpha} \mathcal{D}N_n EN_n \quad (4)$$

$$\sum_{n=1}^{\infty} \mathcal{D}M_n = 1 \quad (5)$$

$$\sum_{n=1}^{\infty} \frac{\mathcal{D}M_n + EM_n \sigma}{1 + AH_n \sigma + BH_n \sigma^2} = \frac{4\alpha^2 - \frac{4\alpha \cos^2(\alpha/2)}{\sin \alpha} Y(\sigma)}{4\alpha^2 + Y^2(\sigma)} \quad (6)$$

It is

$$\frac{1-a^{-l\sigma}}{l\sigma} \left(\sum_{n=1}^{n=\infty} DH_n \frac{1+EH_n\sigma}{1+AH_n\sigma+BH_n\sigma^2} \right) = \frac{1-a^{-l\sigma}}{l\sigma} - \frac{1-a^{-l\sigma}}{l} \sum_{n=1}^{n=\infty} DH_n \frac{AH_n-EH_n+BH_n\sigma}{1+AH_n\sigma+BH_n\sigma^2} \quad (7)$$

$$\sum_{n=1}^{n=\infty} DH_n (AH_n - EH_n) = \lim_{\sigma \rightarrow 0} \left(\frac{1}{\sigma} - \frac{1}{\sigma} \cdot \frac{4\alpha^2}{4\alpha^2 + \gamma^2(\sigma)} \right) = \lim_{\sigma \rightarrow 0} \frac{2Y(\sigma)Y'(\sigma)}{4\alpha^2 + \gamma^2(\sigma) + \sigma 2Y(\sigma)Y'(\sigma)} \quad (8)$$

Taking into account eqs. (9) and (10) of appendix 11 we get

$$\sum_{n=1}^{n=\infty} DH_n (AH_n - EH_n) = 0 \quad (9)$$

From eq. (14) of appendix 11 and eqs. (1) and (3) of appendix 12 we get

$$\left[\sum_{n=1}^{n=\infty} \frac{\bar{L}_n}{1+\sigma/\sigma_n^*} \right] \left[\sum_{n=1}^{n=\infty} DH_n \frac{1+EH_n\sigma}{1+AH_n\sigma+BH_n\sigma^2} \right] = \sum_{n=1}^{n=\infty} \frac{DK\tau_n + EK\tau_n\sigma}{1+AH_n\sigma+BH_n\sigma^2} + \sum_{n=1}^{n=\infty} \frac{\bar{L}_n}{1+\sigma/\sigma_n^*} \quad (10)$$

$$\text{with } \sum_{n=1}^{n=\infty} DK\tau_n = 0 \quad (11)$$

$-\sigma_n^a$ and $-\bar{\sigma}_n^a$ are the complex conjugate roots of the equation

$$1 + AH_n\sigma + BH_n\sigma^2 = 0 \quad (12)$$

Taking into account eq. (10) of appendix 12 we put

$$R\tau_n + jI\tau_n = DH_n (1 - EH_n\sigma_n^a) \frac{l(1+m)}{m(\gamma+4e)} \left(\frac{1+m}{2j\alpha} + \frac{1}{l\sigma_n^a} \right) \quad (13)$$

and get

$$DK\tau_n - EK\tau_n\sigma_n^a = R\tau_n + jI\tau_n \quad (14)$$

$$DK\tau_n - EK\tau_n\bar{\sigma}_n^a = R\tau_n - jI\tau_n \quad (15)$$

Putting

$$\sigma_n^a = \mu_n^a - j\nu_n^a$$

from eqs. (14) and (15) we obtain

$$DK\tau_n = R\tau_n + \frac{\mu_n^a}{\nu_n^a} I\tau_n \quad (16)$$

$$EK\gamma_n = \frac{I\gamma_n}{v_n^a} \quad (17)$$

According to eq. (14) of appendix 11 and eqs. (1) and (3) of appendix 12

it is

$$\left[\sum_{n=1}^{n=\infty} \frac{\overline{L'_n}}{1 + \sigma/\sigma_n^*} \right] \left[\sum_{n=1}^{n=\infty} DH_n \frac{1 + EH_n\sigma}{1 + AH_n\sigma + BH_n\sigma^2} \right] = \sum_{n=1}^{n=\infty} \frac{DK\delta_n + EK\delta_n\sigma}{1 + AH_n\sigma + BH_n\sigma^2} + \sum_{n=1}^{n=\infty} \frac{\overline{L'_n}}{1 + \sigma/\sigma_n^*} \quad (18)$$

with $\sum_{n=1}^{n=\infty} DK\delta_n = 0$ (19)

Putting

$$R\delta_n + jI\delta_n = DH_n (1 - EH_n\sigma_n^a) \left(\sum_{k=1}^{k=\infty} \frac{\overline{L'_k}}{1 - \frac{\sigma_n^a}{\sigma_k^*}} \right) \quad (20)$$

from eq. (18) we get

$$DK\delta_n - EK\delta_n\sigma_n^a = R\delta_n + jI\delta_n \quad (21)$$

$$DK\delta_n - EK\delta_n\overline{\sigma_n^a} = R\delta_n - jI\delta_n \quad (22)$$

$$DK\delta_n = R\delta_n + \frac{I\delta_n}{v_n^a} \mu_n^a \quad (23)$$

$$EK\delta_n = \frac{I\delta_n}{v_n^a} \quad (24)$$

It is

$$\left(\sum_{n=1}^{n=\infty} \overline{C}_n \frac{1 + \overline{G}_n\sigma}{1 + \overline{A}_n\sigma + \overline{B}_n\sigma^2} \right) \left(\sum_{n=1}^{n=\infty} DH_n \frac{1 + EH_n\sigma}{1 + AH_n\sigma + BH_n\sigma^2} \right) =$$

$$= S_4 \sum_{n=1}^{n=\infty} \frac{DK\gamma_n + EK\gamma_n\sigma}{1 + \overline{A}_n\sigma + \overline{B}_n\sigma^2} + (1 - S_4) \sum_{n=1}^{n=\infty} \frac{DK10_n + EK10_n\sigma}{1 + AH_n\sigma + BH_n\sigma^2} \quad (25)$$

with

$$\sum_{n=1}^{n=\infty} DK\gamma_n = \sum_{n=1}^{n=\infty} DK10_n = 1 \quad (26)$$

The complex conjugate roots of the equation

$$1 + \bar{A}_n \sigma + \bar{B}_n \sigma^2 = 0 \quad (27)$$

are $-\sigma_n'$ and $-\bar{\sigma}_n'$ and those of the equation

$$1 + A_n \sigma + B_n \sigma^2 = 0 \quad (28)$$

are $-\sigma_n^a$ and $-\bar{\sigma}_n^a$.

Putting

$$Rg_n + jIg_n = \bar{C}_n (1 - \bar{G}_n \sigma_n') \frac{4\alpha^2}{4\alpha^2 + \gamma^2 (-\sigma_n')} \quad (29)$$

and

$$R10_n + jI10_n = DH_n (1 - EH_n \sigma_n^a) \left(\sum_{k=1}^{k=\infty} \bar{C}_k \frac{1 - \bar{G}_k \sigma_n^a}{1 - \bar{A}_k \sigma_n^a + \bar{B}_k (\sigma_n^a)^2} \right) \quad (30)$$

from eq. (25) we get

$$DKg_n - EKg_n \sigma_n' = \frac{1}{S_4} (Rg_n + jIg_n) \quad (31)$$

$$DKg_n - EKg_n \bar{\sigma}_n' = \frac{1}{S_4} (Rg_n - jIg_n) \quad (32)$$

$$DK10_n - EK10_n \sigma_n^a = \frac{1}{1 - S_4} (R10_n + jI10_n) \quad (33)$$

$$DK10_n - EK10_n \bar{\sigma}_n^a = \frac{1}{1 - S_4} (R10_n - jI10_n) \quad (34)$$

Putting

$$\sigma_n' = \mu_n - j\nu_n \quad (35)$$

and

$$\sigma_n^a = \mu_n^a - j\nu_n^a \quad (36)$$

from eqs. (31) and (32) respectively from eqs. (33) and (34) we obtain

$$DKg_n = \frac{1}{S_4} \left(Rg_n + \frac{\mu_n}{\nu_n} Ig_n \right) \quad (37)$$

$$EKg_n = \frac{1}{S_4} \frac{Ig_n}{\nu_n} \quad (38)$$

$$DK10_n = \frac{1}{1-S_4} \left(R10_n + \frac{\mu_n^Q}{v_n^Q} I10_n \right) \quad (39)$$

$$EK10_n = \frac{1}{1-S_4} \frac{I10_n}{v_n^Q} \quad (40)$$

Since it is

$$\sum_{n=1}^{n=\infty} DK9_n = \sum_{n=1}^{n=\infty} DK10_n = 1 \quad (41)$$

we get

$$S_4 = \sum_{n=1}^{n=\infty} \left(R9_n + \frac{\mu_n^Q}{v_n^Q} I9_n \right) \quad (42)$$

$$1-S_4 = \sum_{n=1}^{n=\infty} \left(R10_n + \frac{\mu_n^Q}{v_n^Q} I10_n \right) \quad (43)$$

It is

$$\left[\sum_{n=1}^{n=\infty} \frac{DM_n + EM_n \sigma}{1 + AH_n \sigma + BH_n \sigma^2} \right] \left[\sum_{n=1}^{n=\infty} \frac{1 + \bar{E}_n \sigma}{\bar{D}_n (1 + \bar{A}_n \sigma + \bar{B}_n \sigma^2)} \right] =$$

$$= S_5 \sum_{n=1}^{n=\infty} \frac{DK11_n + EK11_n \sigma}{1 + \bar{A}_n \sigma + \bar{B}_n \sigma^2} + (1-S_5) \sum_{n=1}^{n=\infty} \frac{DK12_n + EK12_n \sigma}{1 + AH_n \sigma + BH_n \sigma^2} \quad (44)$$

with

$$\sum_{n=1}^{n=\infty} DK11_n = \sum_{n=1}^{n=\infty} DK12_n = 1 \quad (45)$$

Putting

$$R11_n + jI11_n = \bar{D}_n (1 - \bar{E}_n \sigma'_n) \frac{4\alpha^2 - \frac{4\alpha \cos^2(\theta/2)}{\sin \alpha} \gamma(-\sigma'_n)}{4\alpha^2 + \gamma^2(-\sigma'_n)} \quad (46)$$

and

$$R12 + jI12_n = (DM_n - EM_n \sigma_n^Q) \left(\sum_{k=1}^{k=\infty} \frac{\bar{D}_k (1 - \bar{E}_k \sigma_n^Q)}{1 - \bar{A}_k \sigma_n^Q + \bar{B}_k (\sigma_n^Q)^2} \right) \quad (47)$$

from eq. (44) we get

$$DK11_n - EK11_n \sigma'_n = \frac{1}{S_5} (R11_n + jI11_n) \quad (48)$$

$$DK11_n - EK11_n \bar{\sigma}_n = \frac{1}{S_5} (R11_n - jI11_n) \quad (49)$$

$$DK12_n - EK12_n \sigma_n^Q = \frac{1}{1-S_5} (R12_n + jI12_n) \quad (50)$$

$$DK12_n - EK12_n \bar{\sigma}_n^Q = \frac{1}{1-S_5} (R12_n - jI12_n) \quad (51)$$

From eqs. (48) to (51) we get finally

$$DK11_n = \frac{1}{S_5} (R11_n + \frac{\mu_n}{\nu_n} I11_n) \quad (52)$$

$$EK11_n = \frac{1}{S_5} \frac{I11_n}{\nu_n} \quad (53)$$

$$DK12_n = \frac{1}{1-S_5} (R12_n + \frac{\mu_n^Q}{\nu_n^Q} I12_n) \quad (54)$$

$$EK12_n = \frac{1}{1-S_5} \frac{I12_n}{\nu_n^Q} \quad (55)$$

Since it is

$$\sum_{n=1}^{n=\infty} DK11_n = \sum_{n=1}^{n=\infty} DK12_n = 1 \quad (56)$$

we get

$$S_5 = \sum_{n=1}^{n=\infty} (R11_n + \frac{\mu_n}{\nu_n} I11_n) \quad (57)$$

and

$$1-S_5 = \sum_{n=1}^{n=\infty} (R12_n + \frac{\mu_n^Q}{\nu_n^Q} I12_n) \quad (58)$$

Combining eqs. (2), (4), (10), (18), (25) and (44) we get finally

$$\begin{aligned} W_{\text{eff}}(\sigma) = & W_{\text{eff}1} \frac{1-a^{-l\sigma}}{l\sigma} + W_{\text{eff}2} \sum_{n=1}^{n=\infty} \frac{\bar{L}_n}{1+\sigma/\sigma_n^*} + W_{\text{eff}3} a^{-l\sigma} \sum_{n=1}^{n=\infty} \frac{\bar{L}'_n}{1+\sigma/\sigma_n^*} + W_{\text{eff}4} \sum_{n=1}^{n=\infty} \text{DH}1_n \frac{1+EH1_n \sigma}{1+AH_n \sigma + BH_n \sigma^2} \\ & + W_{\text{eff}5} a^{-l\sigma} \sum_{n=1}^{n=\infty} \text{DH}2_n \frac{1+EH2_n \sigma}{1+AH_n \sigma + BH_n \sigma^2} + W_{\text{eff}6} a^{-l\sigma} \sum_{n=1}^{n=\infty} \text{DH}3_n \frac{1+EH3_n \sigma}{1+\bar{A}_n \sigma + \bar{B}_n \sigma^2} \quad (59) \end{aligned}$$

where

$$w_{aff1} = \frac{1}{1 + \frac{\sin d}{d}} \frac{1}{1+m} \quad (60)$$

$$w_{aff2} = \frac{1}{1 + \frac{\sin d}{d}} m \frac{\mu + 1/8}{l(1+m)^2} \quad (61)$$

$$w_{aff3} = \frac{1}{1 + \frac{\sin d}{d}} \frac{m}{1+m} \left[\frac{d + 1/8}{l(1+m)} + m(1 - \bar{S}_1) \right] \quad (62)$$

$$w_{aff4} = \frac{1}{1 + \frac{\sin d}{d}} \frac{\sin d}{2d} \quad (63)$$

$$w_{aff5} = \frac{1}{1 + \frac{\sin d}{d}} \left[\left(m - \frac{m^2}{1+m} \bar{S}_1 \right) (1 - S_4) + \frac{\sin d}{2d} w_1 + \frac{\sin d}{2d} (1 - w_1) (1 - S_5) \right] \quad (64)$$

$$w_{aff6} = \frac{1}{1 + \frac{\sin d}{d}} \left[\left(m - \frac{m^2}{1+m} \bar{S}_1 \right) S_4 + \frac{\sin d}{2d} (1 - w_1) S_5 \right] \quad (65)$$

$$DH1_n = DH_n + \frac{4d \cos^2(4/2)}{\sin d} DN_n - \frac{2d}{\sin d} \frac{1}{l(1+m)} DH_n (AH_n - EH_n) + \frac{2d}{\sin d} m \frac{\mu + 1/8}{l(1+m)^2} DK17_n \quad (66)$$

$$EH1_n = \frac{1}{DH1_n} \left[DH_n EH_n + \frac{4d \cos^2(4/2)}{\sin d} DN_n EN_n - \frac{2d}{\sin d} \frac{1}{l(1+m)} DH_n BH_n + \frac{2d}{\sin d} m \frac{\mu + 1/8}{l(1+m)^2} EK17_n \right] \quad (67)$$

$$DH2_n = \frac{1}{w_{aff5} (1 + \frac{\sin d}{d})} \left\{ \frac{DH_n (AH_n - EH_n)}{l(1+m)} - \left[m \frac{\mu + 1/8}{l(1+m)^2} + \frac{m^2}{1+m} (1 - \bar{S}_1) \right] DK8_n + \left(m - \frac{m^2}{1+m} \bar{S}_1 \right) (1 - S_4) DK10_n + \frac{\sin d}{2d} \left[w_1 DM_n + (1 - w_1) (1 - S_5) DK12_n \right] \right\} \quad (68)$$

$$EH2_n = \frac{1}{DH2_n w_{aff5} (1 + \frac{\sin d}{d})} \left\{ \frac{DH_n BH_n}{l(1+m)} - \left[m \frac{\mu + 1/8}{l(1+m)^2} + \frac{m^2}{1+m} (1 - \bar{S}_1) \right] EK8_n + \left(m - \frac{m^2}{1+m} \bar{S}_1 \right) (1 - S_4) EK10_n + \frac{\sin d}{2d} \left[w_1 EM_n + (1 - w_1) (1 - S_5) EK12_n \right] \right\} \quad (69)$$

$$DH3_n = \frac{1}{w_{aff6} (1 + \frac{\sin d}{d})} \left[\left(m - \frac{m^2}{1+m} \bar{S}_1 \right) S_4 DK9_n + \frac{\sin d}{2d} (1 - w_1) S_5 DK11_n \right] \quad (70)$$

$$EH3_n = \frac{1}{DH3_n w_{aff6} (1 + \frac{\sin d}{d})} \left[\left(m - \frac{m^2}{1+m} \bar{S}_1 \right) S_4 EK9_n + \frac{\sin d}{2d} (1 - w_1) S_5 EK11_n \right] \quad (71)$$

It is

$$\sum_{i=1}^6 W_{\text{eff}i} = 1 \quad (72)$$

$$\sum_{n=1}^{\infty} DH1_n = \sum_{n=1}^{\infty} DH2_n = \sum_{n=1}^{\infty} DH3_n = 1 \quad (73)$$

From eq. (1) we get

$$\lim_{\sigma \rightarrow \infty} W_{\text{eff}}(\sigma) = \lim_{\sigma \rightarrow \infty} \frac{2}{1 + \frac{\sin \alpha}{\alpha}} \left(\frac{\cos^2(\alpha/2)}{l\sigma} + \frac{\alpha \sin \alpha}{l^2 \sigma^2} \right) \quad (74)$$

From eq. (59) we get

$$\lim_{\sigma \rightarrow \infty} W_{\text{eff}}(\sigma) = \lim_{\sigma \rightarrow \infty} \left\{ \frac{1}{\sigma} \left[\frac{W_{\text{eff}1}}{l} + W_{\text{eff}2} \frac{1+m}{\mu+1/8} + W_{\text{eff}4} \sum_{n=1}^{\infty} \frac{DH1_n EH1_n}{BH_n} \right] + \frac{1}{\sigma^2} W_{\text{eff}4} \sum_{n=1}^{\infty} \frac{DH1_n}{BH_n} \left(1 - \frac{EH1_n AH1_n}{BH_n} \right) \right\} \quad (75)$$

Comparing (74) to (75) we get

$$\sum_{n=1}^{\infty} \frac{DH1_n EH1_n}{BH_n} = \frac{2 \alpha \cos \alpha}{l \sin \alpha} \quad (76)$$

$$\sum_{n=1}^{\infty} \frac{DH1_n}{BH_n} \left(1 - \frac{EH1_n AH1_n}{BH_n} \right) = \frac{4 \alpha^2}{l^2} \quad (77)$$

Appendix 14

In this appendix we want to obtain the expression (2) of para 4.4.

We start from

$$V_{\text{eff}}(\sigma) = 2 \frac{F_2(\sigma) Y(\sigma)}{d^2 + Y^2(\sigma)} \left[2 \frac{1 - \frac{1}{3} \sin^2(d/2)}{1 + \frac{\sin d}{d}} - \frac{(d/2) \cos(d/2)}{\sin(d/2)} W_{\text{eff}}(\sigma) \right] + \frac{F_2(\sigma) d^2}{d^2 + Y^2(\sigma)} W_{\text{eff}}(\sigma) \quad (1)$$

According to the eqs. (1) and (2) of appendix 8 and the eqs. (1) and (2) of para 11 and eqs. (3), (4), (5) and (6) of appendix 11 eq. (1) can be written as follows

$$V_{\text{eff}}(\sigma) = 4 \frac{1 - \frac{1}{3} \sin^2(d/2)}{1 + \frac{\sin d}{d}} \sum_{n=1}^{\infty} DZ_n \frac{1 + EZ_n \sigma}{1 + AS_n \sigma + BS_n \sigma^2} + \left(\sum_{n=1}^{\infty} \frac{DK_n + EK_n \sigma}{1 + AS_n \sigma + BS_n \sigma^2} \right) \left(W_{\text{eff}1} \frac{1 - a^{-l\sigma}}{l\sigma} + W_{\text{eff}2} \sum_{n=1}^{\infty} \frac{\bar{L}_n}{1 + \sigma/\sigma_n^*} \right) + W_{\text{eff}3} a^{-l\sigma} \sum_{n=1}^{\infty} \frac{\bar{L}'_n}{1 + \sigma/\sigma_n^*} + W_{\text{eff}4} \sum_{n=1}^{\infty} DH1_n \frac{1 + EH1_n \sigma}{1 + AH_n \sigma + BH_n \sigma^2} + W_{\text{eff}5} a^{-l\sigma} \sum_{n=1}^{\infty} DH2_n \frac{1 + EH2_n \sigma}{1 + AH_n \sigma + BH_n \sigma^2} + W_{\text{eff}6} a^{-l\sigma} \sum_{n=1}^{\infty} DH3_n \frac{1 + EH3_n \sigma}{1 + \bar{A}_n \sigma + \bar{B}_n \sigma^2} \quad (2)$$

One part of the multiplication we have already evaluated in appendix 11 (see eqs. (17), (15) and (23) of appendix 11). Now let us consider the remaining multiplication.

It is

$$\left(\sum_{n=1}^{\infty} DH1_n \frac{1 + EH1_n \sigma}{1 + AH_n \sigma + BH_n \sigma^2} \right) \left(\sum_{n=1}^{\infty} \frac{DK_n + EK_n \sigma}{1 + AS_n \sigma + BS_n \sigma^2} \right) = S_6 \sum_{n=1}^{\infty} \frac{DL1_n + EL1_n \sigma}{1 + AS_n \sigma + BS_n \sigma^2} + (1 - S_6) \sum_{n=1}^{\infty} \frac{DL2_n + EL2_n \sigma}{1 + AH_n \sigma + BH_n \sigma^2} \quad (3)$$

with

$$\sum_{n=1}^{n=\infty} DL1_n = \sum_{n=1}^{n=\infty} DL2_n = 1 \quad (4)$$

The complex conjugate roots of the equation

$$1 + AH_n \sigma + BH_n \sigma^2 = 0 \quad (5)$$

are $-\sigma_n^Q$ and $-\overline{\sigma_n^Q}$ and those of the equation

$$1 + AS_n \sigma + BS_n \sigma^2 = 0 \quad (6)$$

are $-\sigma_n^O$ and $-\overline{\sigma_n^O}$.

Putting

$$RV1_n + jIV1_n = (DK_n - EK_n \sigma_n^O) \left(\sum_{k=1}^{k=\infty} DH1_k \frac{1 - EH1_k \sigma_n^O}{1 - AH_k \sigma_n^O + BH_k (\sigma_n^O)^2} \right) \quad (7)$$

and

$$RV2_n + jIV2_n = DH1_n (1 - EH1_n \sigma_n^Q) \left(\sum_{k=1}^{k=\infty} \frac{DK_k - EK_k \sigma_n^Q}{1 - AS_k \sigma_n^Q + BS_k (\sigma_n^Q)^2} \right) \quad (8)$$

from eq. (3) we get

$$DL1_n - EL1_n \sigma_n^O = \frac{1}{S_b} (RV1_n + jIV1_n) \quad (9)$$

$$DL1_n - EL1_n \overline{\sigma_n^O} = \frac{1}{S_b} (RV1_n - jIV1_n) \quad (10)$$

$$DL2_n - EL2_n \sigma_n^Q = \frac{1}{1 - S_b} (RV2_n + jIV2_n) \quad (11)$$

$$DL2_n - EL2_n \overline{\sigma_n^Q} = \frac{1}{1 - S_b} (RV2_n - jIV2_n) \quad (12)$$

Putting

$$\sigma_n^O = \mu_n^O - j\nu_n^O \quad (13)$$

and

$$\sigma_n^Q = \mu_n^Q - j\nu_n^Q \quad (14)$$

from eqs. (9) and (10) respectively from eqs. (11) and (12) we obtain

$$DL1_n = \frac{1}{S_b} (RV1_n + \frac{\mu_n^O}{\nu_n^O} IV1_n) \quad (15)$$

$$EL1_n = \frac{1}{S_6} \frac{IV1_n}{v_n^0} \quad (16)$$

$$DL2_n = \frac{1}{1-S_6} \left(RV2_n + \frac{\mu_n^a}{v_n^a} IV2_n \right) \quad (17)$$

$$EL2_n = \frac{1}{1-S_6} \frac{IV2_n}{v_n^a} \quad (18)$$

Since it is

$$\sum_{n=1}^{n=\infty} DL1_n = \sum_{n=1}^{n=\infty} DL2_n = 1 \quad (19)$$

we get

$$S_6 = \sum_{n=1}^{n=\infty} \left(RV1_n + \frac{\mu_n^0}{v_n^0} IV1_n \right) \quad (20)$$

$$1-S_6 = \sum_{n=1}^{n=\infty} \left(RV2_n + \frac{\mu_n^a}{v_n^a} IV2_n \right) \quad (21)$$

It is

$$\begin{aligned} & \left(\sum_{n=1}^{n=\infty} DH2_n \frac{1+EH2_n \sigma}{1+AH_n \sigma + BH_n \sigma^2} \right) \left(\sum_{n=1}^{n=\infty} \frac{DK_n + EK_n \sigma}{1+AS_n \sigma + BS_n \sigma^2} \right) = \\ & = S_4 \sum_{n=1}^{n=\infty} \frac{DL3_n + EL3_n \sigma}{1+AS_n \sigma + BS_n \sigma^2} + (1-S_4) \sum_{n=1}^{n=\infty} \frac{DL4_n + EL4_n \sigma}{1+AH_n \sigma + BH_n \sigma^2} \end{aligned} \quad (22)$$

with

$$\sum_{n=1}^{n=\infty} DL3_n = \sum_{n=1}^{n=\infty} DL4_n = 1 \quad (23)$$

Putting

$$RV3_n + jIV3_n = (DK_n - EK_n \sigma_n^0) \left(\sum_{k=1}^{k=\infty} DH2_k \frac{1-EH2_k \sigma_n^0}{1-AH_k \sigma_n^0 + BH_k (\sigma_n^0)^2} \right) \quad (24)$$

and

$$RV4_n + jIV4_n = DH2_n (1-EH2_n \sigma_n^a) \left(\sum_{k=1}^{k=\infty} \frac{DK_k - EK_k \sigma_n^a}{1-AS_k \sigma_n^a + BS_k (\sigma_n^a)^2} \right) \quad (25)$$

from eq. (22) we get finally

$$DL3_n = \frac{1}{S_4} (RV3_n + \frac{\mu_n^0}{v_n^0} IV3_n) \quad (26)$$

$$EL3_n = \frac{1}{S_4} \frac{IV3_n}{v_n^0} \quad (27)$$

$$DL4_n = \frac{1}{1-S_4} (RV4_n + \frac{\mu_n^Q}{v_n^Q} IV4_n) \quad (28)$$

$$EL4_n = \frac{1}{1-S_4} \frac{IV4_n}{v_n^Q} \quad (29)$$

Since it is

$$\sum_{n=1}^{n=\infty} DL3_n = \sum_{n=1}^{n=\infty} DL4_n = 1 \quad (30)$$

we get

$$S_4 = \sum_{n=1}^{n=\infty} (RV3_n + \frac{\mu_n^0}{v_n^0} IV3_n) \quad (31)$$

and

$$1-S_4 = \sum_{n=1}^{n=\infty} (RV4_n + \frac{\mu_n^Q}{v_n^Q} IV4_n) \quad (32)$$

It is

$$\begin{aligned} & \left(\sum_{n=1}^{n=\infty} DH3_n \frac{1+EH3_n\sigma}{1+\bar{A}_n\sigma+\bar{B}_n\sigma^2} \right) \left(\sum_{n=1}^{n=\infty} \frac{DK_n+EK_n\sigma}{1+AS_n\sigma+BS_n\sigma^2} \right) = \\ & = S_4 \sum_{n=1}^{n=\infty} \frac{DL5_n+EL5_n\sigma}{1+AS_n\sigma+BS_n\sigma^2} + (1-S_4) \sum_{n=1}^{n=\infty} \frac{DL6_n+EL6_n\sigma}{1+\bar{A}_n\sigma+\bar{B}_n\sigma^2} \end{aligned} \quad (33)$$

with

$$\sum_{n=1}^{n=\infty} DL5_n = \sum_{n=1}^{n=\infty} DL6_n = 1 \quad (34)$$

The complex conjugate roots of the equation

$$1 + \bar{A}_n\sigma + \bar{B}_n\sigma^2 = 0 \quad (35)$$

are $-\sigma_n'$ and $\bar{\sigma}_n'$

$$\sigma_n' = \mu_n - j v_n \quad (36)$$

Putting

$$RV5_n + jIV5_n = (DK_n - EK_n \sigma_n^0) \left(\sum_{k=1}^{k=\infty} DH3_k \frac{1 - EH3_k \sigma_n^0}{1 - AH_k \sigma_n^0 + BH_k (\sigma_n^0)^2} \right) \quad (37)$$

and

$$RV6_n + jIV6_n = DH3_n (1 - EH3_n \sigma_n^1) \left(\sum_{k=1}^{k=\infty} \frac{DK_k - EK_k \sigma_n^1}{1 - AS_k \sigma_n^1 + BS_k (\sigma_n^1)^2} \right) \quad (38)$$

from eq. (33) we get

$$DL5_n = \frac{1}{S_8} (RV5_n + \frac{\mu_n^0}{v_n^0} IV5_n) \quad (39)$$

$$EL5_n = \frac{1}{S_8} \frac{IV5_n}{v_n^0} \quad (40)$$

$$DL6_n = \frac{1}{1 - S_8} (RV6_n + \frac{\mu_n}{v_n} IV6_n) \quad (41)$$

$$EL6_n = \frac{1}{1 - S_8} \frac{IV6_n}{v_n} \quad (42)$$

Since it is

$$\sum_{n=1}^{n=\infty} DL5_n = \sum_{n=1}^{n=\infty} DL6_n = 1 \quad (43)$$

we get

$$S_8 = \sum_{n=1}^{n=\infty} (RV5_n + \frac{\mu_n^0}{v_n^0} IV5_n) \quad (44)$$

and

$$1 - S_8 = \sum_{n=1}^{n=\infty} (RV6_n + \frac{\mu_n}{v_n} IV6_n) \quad (45)$$

Combining eqs. (2), (3), (22) and (33) and the eqs. (17), (15) and (23) of appendix 11 we get finally

$$\begin{aligned}
 V_{\text{eff}}(\sigma) = & V_{\text{eff}1} \frac{1-a^{-l\sigma}}{l\sigma} + V_{\text{eff}2} \sum_{n=1}^{\infty} \frac{\bar{L}_n}{1+\sigma/\sigma_n^*} + V_{\text{eff}3} a^{-l\sigma} \sum_{n=1}^{\infty} \frac{\bar{L}'_n}{1+\sigma/\sigma_n^*} + \\
 & + V_{\text{eff}4} \sum_{n=1}^{\infty} DI1_n \frac{1+EI1_n\sigma}{1+AS_n\sigma+BS_n\sigma^2} + V_{\text{eff}5} \sum_{n=1}^{\infty} DI2_n \frac{1+EI2_n\sigma}{1+AH_n\sigma+BH_n\sigma^2} + \\
 & + V_{\text{eff}6} a^{-l\sigma} \sum_{n=1}^{\infty} DI3_n \frac{1+EI3_n\sigma}{1+AS_n\sigma+BS_n\sigma^2} + V_{\text{eff}7} a^{-l\sigma} \sum_{n=1}^{\infty} DI4_n \frac{1+EI4_n\sigma}{1+AH_n\sigma+BH_n\sigma^2} \\
 & + V_{\text{eff}8} a^{-l\sigma} \sum_{n=1}^{\infty} DI5_n \frac{1+EI5_n\sigma}{1+\bar{A}_n\sigma+\bar{B}_n\sigma^2} \quad (46)
 \end{aligned}$$

where

$$V_{\text{eff}1} = \frac{1}{1+\frac{\sin d}{d}} \frac{1}{1+m} \quad (47)$$

$$V_{\text{eff}2} = -\frac{1}{1+\frac{\sin d}{d}} \frac{\mu+1/8}{l(1+m)^2} \quad (48)$$

$$V_{\text{eff}3} = \frac{1}{1+\frac{\sin d}{d}} \left[\frac{\mu+1/8}{l(1+m)^2} + \frac{m}{1+m} (1-\bar{S}_1) \right] \quad (49)$$

$$V_{\text{eff}4} = \frac{1}{1+\frac{\sin d}{d}} \left(\frac{\sin d}{2d} S_6 - \frac{\cos(d/2)}{d \sin(d/2)} \right) \quad (50)$$

$$V_{\text{eff}5} = \frac{1}{1+\frac{\sin d}{d}} \frac{\sin d}{2d} (1-S_6) \quad (51)$$

$$V_{\text{eff}6} = W_{\text{eff}5} S_7 + W_{\text{eff}6} S_8 + \frac{1}{1+\frac{\sin d}{d}} \left[\frac{\cos(d/2)}{d \sin(d/2)} - m(1-\bar{S}_1) \right] \quad (52)$$

$$V_{\text{eff}7} = W_{\text{eff}5} (1-S_7) \quad (53)$$

$$V_{\text{eff}8} = W_{\text{eff}6} (1-S_8) \quad (54)$$

$$\begin{aligned}
 DI1_n = & \frac{1}{V_{\text{eff}4} (1+\frac{\sin d}{d})} \left\{ \frac{\mu+1/8}{l(1+m)} DK3_n + \frac{\sin d}{2d} S_6 DL1_n - \right. \\
 & \left. - \frac{1}{l(1+m)} (DK_n AS_n - EK_n) + 4 \frac{1-1/3 \sin^2(d/2)}{1+\frac{\sin d}{d}} DZ_n \right\} \quad (55)
 \end{aligned}$$

$$EI1_n = \frac{1}{DI1_n v_{aff4} (1 + \frac{\sin \alpha}{\alpha})} \left\{ \frac{\mu + 1/8}{l(1+m)} EK3_n + \frac{\sin \alpha}{2\alpha} S_6 EL1_n - \frac{1}{l(1+m)} DK_n BS_n + 4 \frac{1 - 1/3 \sin^2(\alpha/2)}{1 + \frac{\sin \alpha}{\alpha}} DZ_n EZ_n \right\} \quad (56)$$

$$DI2_n = DL2_n \quad (57)$$

$$EI2_n = \frac{EL2_n}{DL2_n} \quad (58)$$

$$DI3_n = \frac{1}{v_{aff6}} \left\{ w_{aff5} S_7 DL3_n + w_{aff6} S_8 DL5_n - \frac{1}{1 + \frac{\sin \alpha}{\alpha}} \left(\frac{\mu + 1/8}{l(1+m)} + m(1 - \bar{S}_1) \right) DK4_n + \frac{1}{1 + \frac{\sin \alpha}{\alpha}} \frac{1}{l(1+m)} (DK_n AS_n - EK_n) \right\} \quad (59)$$

$$EI3_n = \frac{1}{v_{aff6} DI3_n} \left\{ w_{aff5} S_7 EL3_n + w_{aff6} S_8 EL5_n - \frac{1}{1 + \frac{\sin \alpha}{\alpha}} \left(\frac{\mu + 1/8}{l(1+m)} + m(1 - \bar{S}_1) \right) EK4_n + \frac{1}{1 + \frac{\sin \alpha}{\alpha}} \frac{1}{l(1+m)} DK_n BS_n \right\} \quad (60)$$

$$DI4_n = DL4_n \quad (61)$$

$$EI4_n = \frac{EL4_n}{DL4_n} \quad (62)$$

$$DI5_n = DL6_n \quad (63)$$

$$EI5_n = \frac{EL6_n}{DL6_n} \quad (64)$$

It is

$$\sum_{i=1}^8 v_{affi} = 1 \quad (65)$$

$$\sum_{n=1}^{n=\infty} DI1_n = \sum_{n=1}^{n=\infty} DI2_n = \sum_{n=1}^{n=\infty} DI3_n = \sum_{n=1}^{n=\infty} DI4_n = \sum_{n=1}^{n=\infty} DI5_n = \sum_{n=1}^{n=\infty} DI6_n = 1 \quad (66)$$

From eq. (4) we get

$$\lim_{\sigma \rightarrow \infty} V_{\text{eff}}(\sigma) = \lim_{\sigma \rightarrow \infty} \left(4 \frac{1 - \frac{1}{3} \sin^2(\alpha/2)}{1 + \frac{\sin \alpha}{\alpha}} \frac{1}{l \sigma^2} \right) \quad (67)$$

From eq. (46) we get

$$\begin{aligned} \lim_{\sigma \rightarrow \infty} V_{\text{eff}}(\sigma) = \lim_{\sigma \rightarrow \infty} & \left\{ v_{\text{eff}1} \frac{1}{l\sigma} + v_{\text{eff}2} \frac{1}{\sigma} \sum_{n=1}^{\infty} \bar{L}_n \sigma_n^* + \right. \\ & + v_{\text{eff}4} \frac{1}{\sigma} \sum_{n=1}^{\infty} \frac{DI_1}{BS_n} EI_1 + v_{\text{eff}4} \frac{1}{\sigma^2} \sum_{n=1}^{\infty} \frac{DI_1}{BS_n} \left(1 - \frac{AS_n EI_1}{BS_n} \right) \\ & \left. + v_{\text{eff}5} \frac{1}{\sigma} \sum_{n=1}^{\infty} \frac{DI_2}{BH_n} EI_2 + v_{\text{eff}5} \frac{1}{\sigma^2} \sum_{n=1}^{\infty} \frac{DI_2}{BH_n} \left(1 - \frac{AH_n EI_2}{BH_n} \right) \right\} \quad (68) \end{aligned}$$

From eq. (66) of appendix A it is

$$v_{\text{eff}1} \frac{1}{l\sigma} + v_{\text{eff}2} \frac{1}{\sigma} \sum_{n=1}^{\infty} \bar{L}_n \sigma_n^* = 0 \quad (69)$$

Comparing (67) to (68) we get

$$v_{\text{eff}4} \sum_{n=1}^{\infty} \frac{DI_1 EI_1}{BS_n} + v_{\text{eff}5} \sum_{n=1}^{\infty} \frac{DI_2 EI_2}{BH_n} = 0 \quad (70)$$

$$\begin{aligned} & v_{\text{eff}4} \sum_{n=1}^{\infty} \frac{DI_1}{BS_n} \left(1 - \frac{AS_n EI_1}{BS_n} \right) + v_{\text{eff}5} \sum_{n=1}^{\infty} \frac{DI_2}{BH_n} \left(1 - \frac{AH_n EI_2}{BH_n} \right) = \\ & = 4 \frac{1 - \frac{1}{3} \sin^2(\alpha/2)}{1 + \frac{\sin \alpha}{\alpha}} \frac{1}{l \sigma^2} \quad (71) \end{aligned}$$

Bibliography

1. L. CALDAROLA and E. G. SCHLECHTENDAHL:

Reactor Temperature Transients with Spatial Variables. Part 1: Radial
Analysis, KFK 223, Mai 1964.

2. G. DOETSCH: Anleitung zum praktischen Gebrauch der Laplace-Transformation

München: R. Oldenbourg, 1961

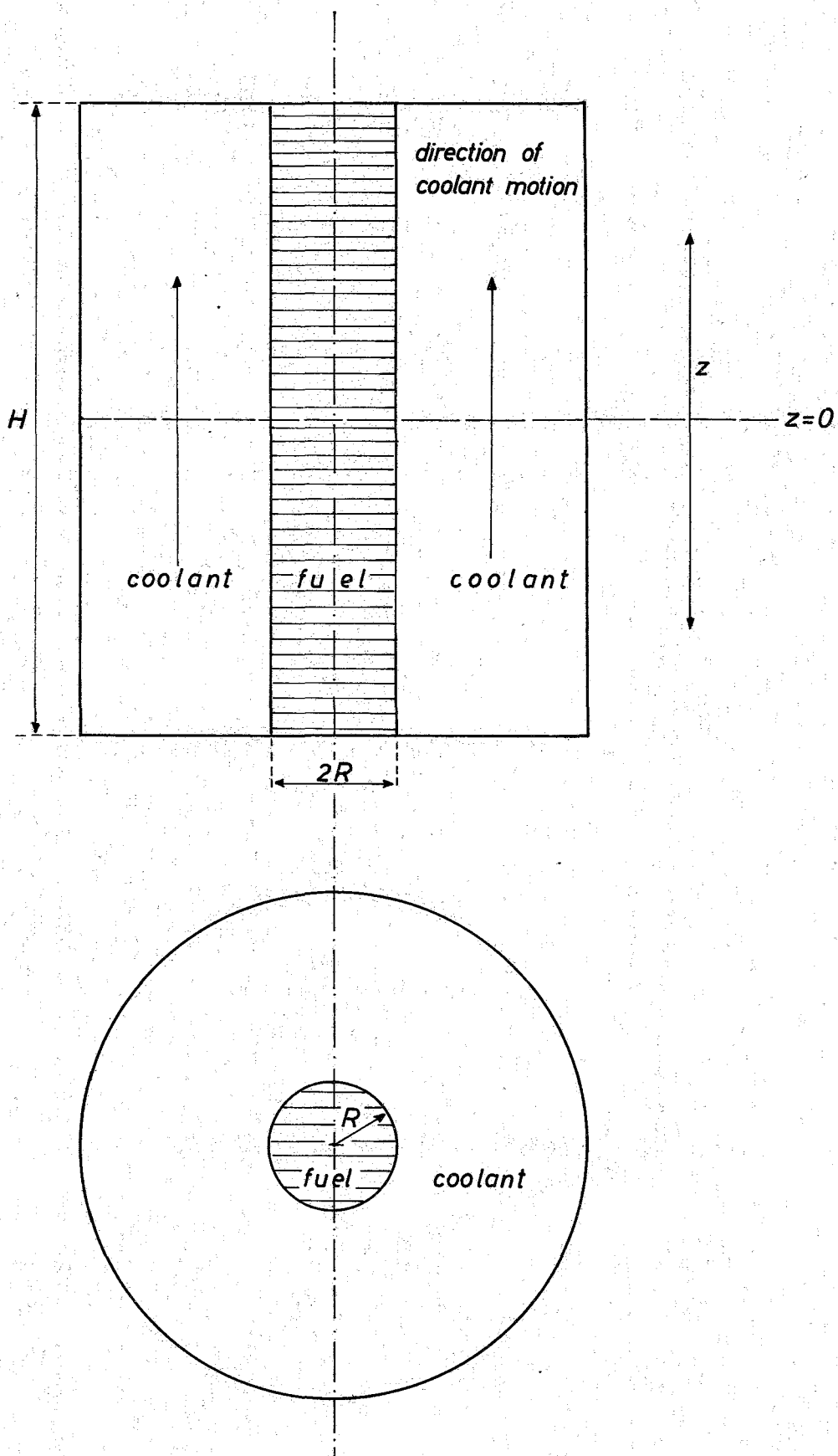

Reactor channel - Cross sections

Fig. 1

curve 1 $f(\sigma) = \bar{W}(\sigma)$
curve 2 $f(\sigma) = W(\sigma, x=0.5)$

parameters

$\gamma = 0.07$

$m = 5$

$l = 0.002$

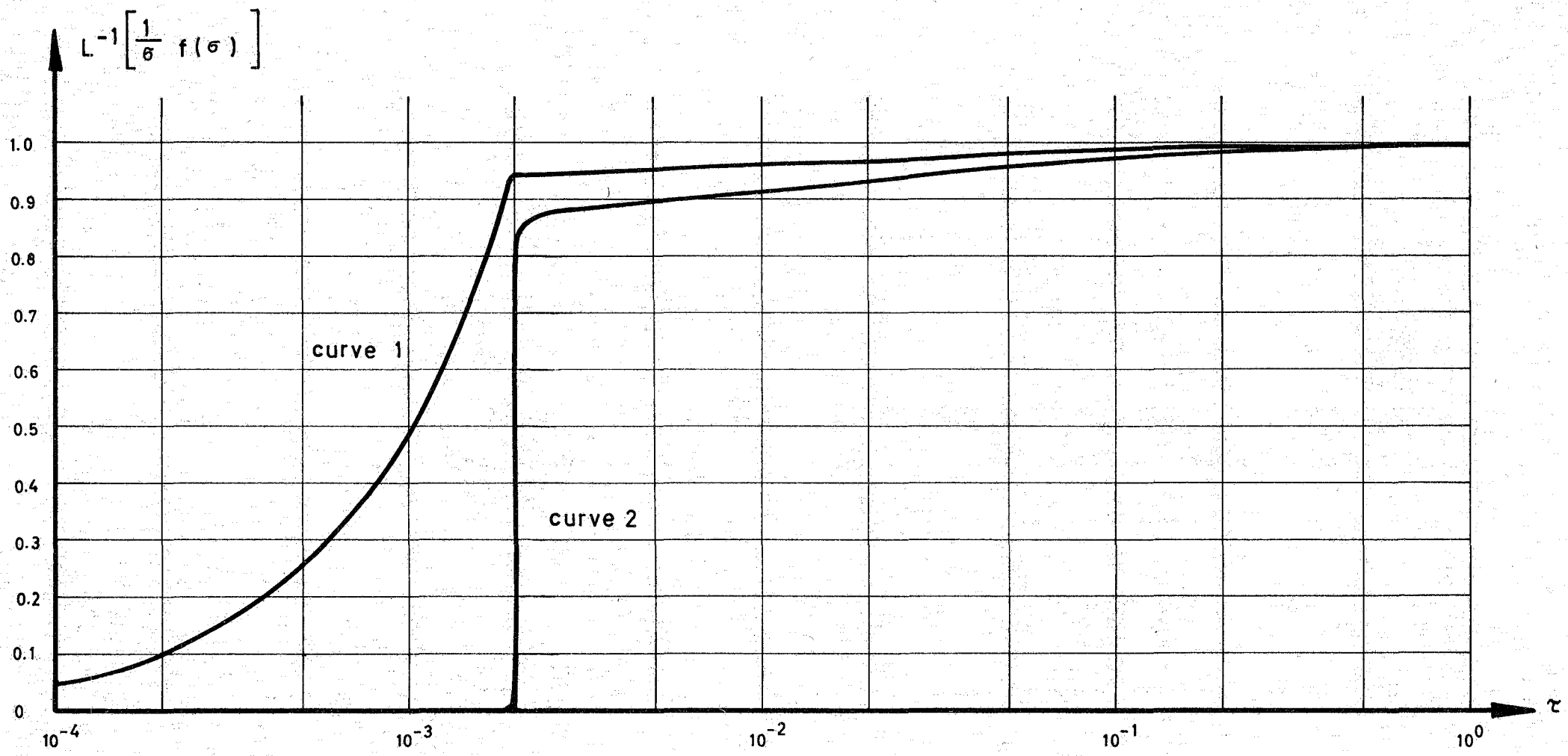

Fig. 2

curve	parameters
1 x = -0.2	$\delta = 0.07$
2 x = 0.	m = 5.
3 x = 0.3	l = 0.002
4 x = 0.5	

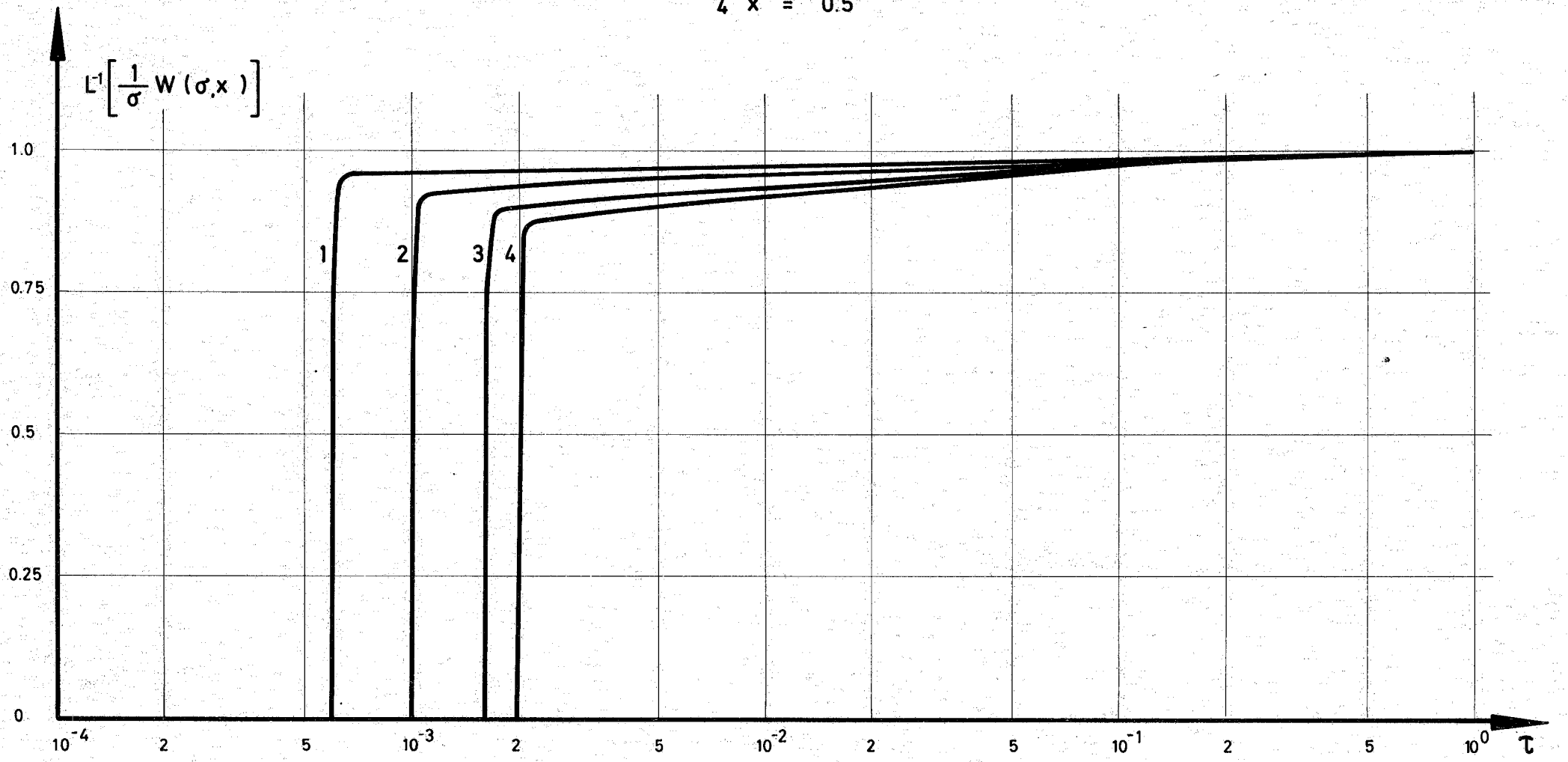

Fig. 3

curve 1 $f(\sigma) = \bar{W}(\sigma)$

curve 2 $f(\sigma) = W(\sigma, x=0.5)$

parameters

$\tau = 0.07$

$m = 5$

$l = 0.02$

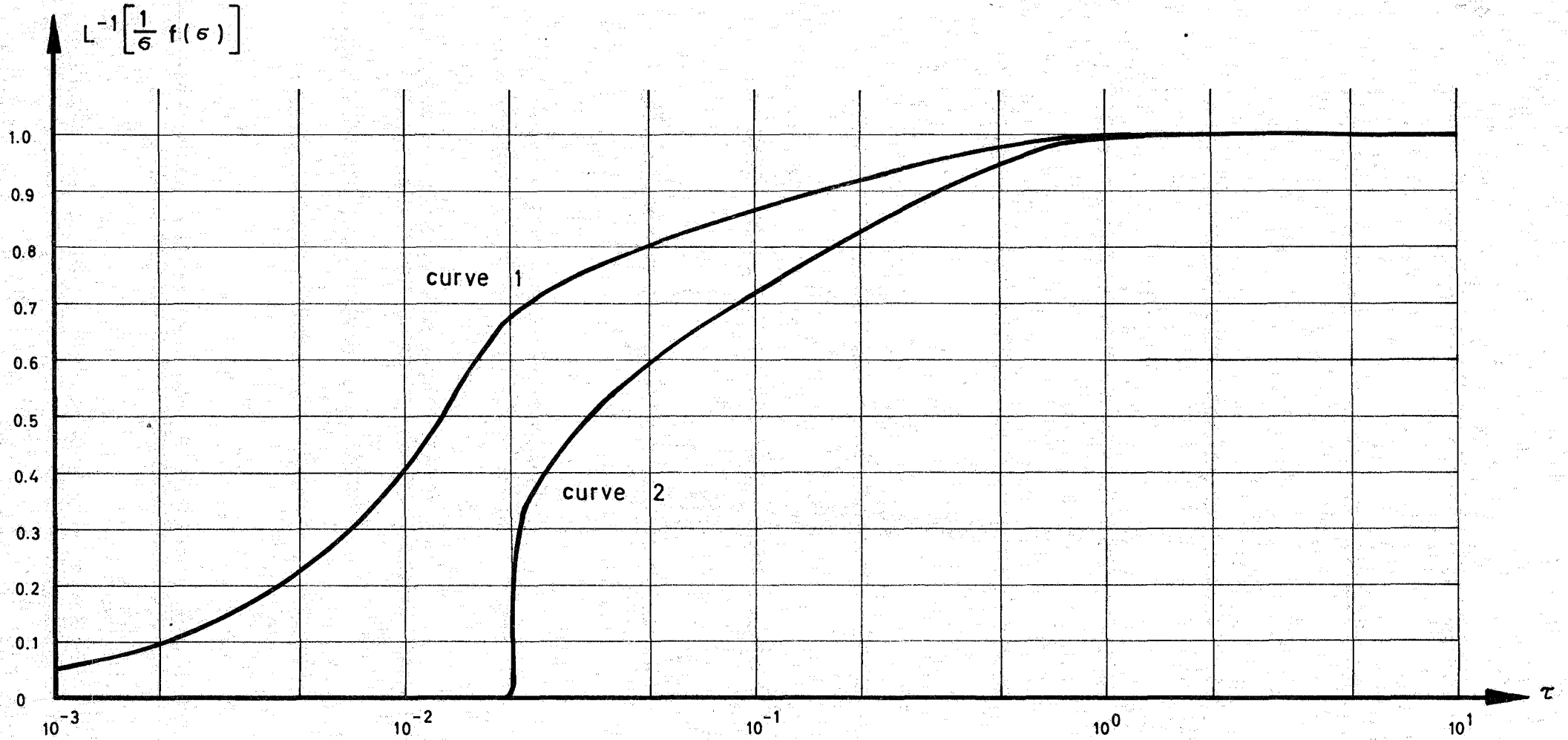

Fig. 4

curve

- 1 $l = 0.0002$
- 2 $l = 0.002$
- 3 $l = 0.02$

parameters

- $\sigma = 0.07$
- $m = 5$
- l

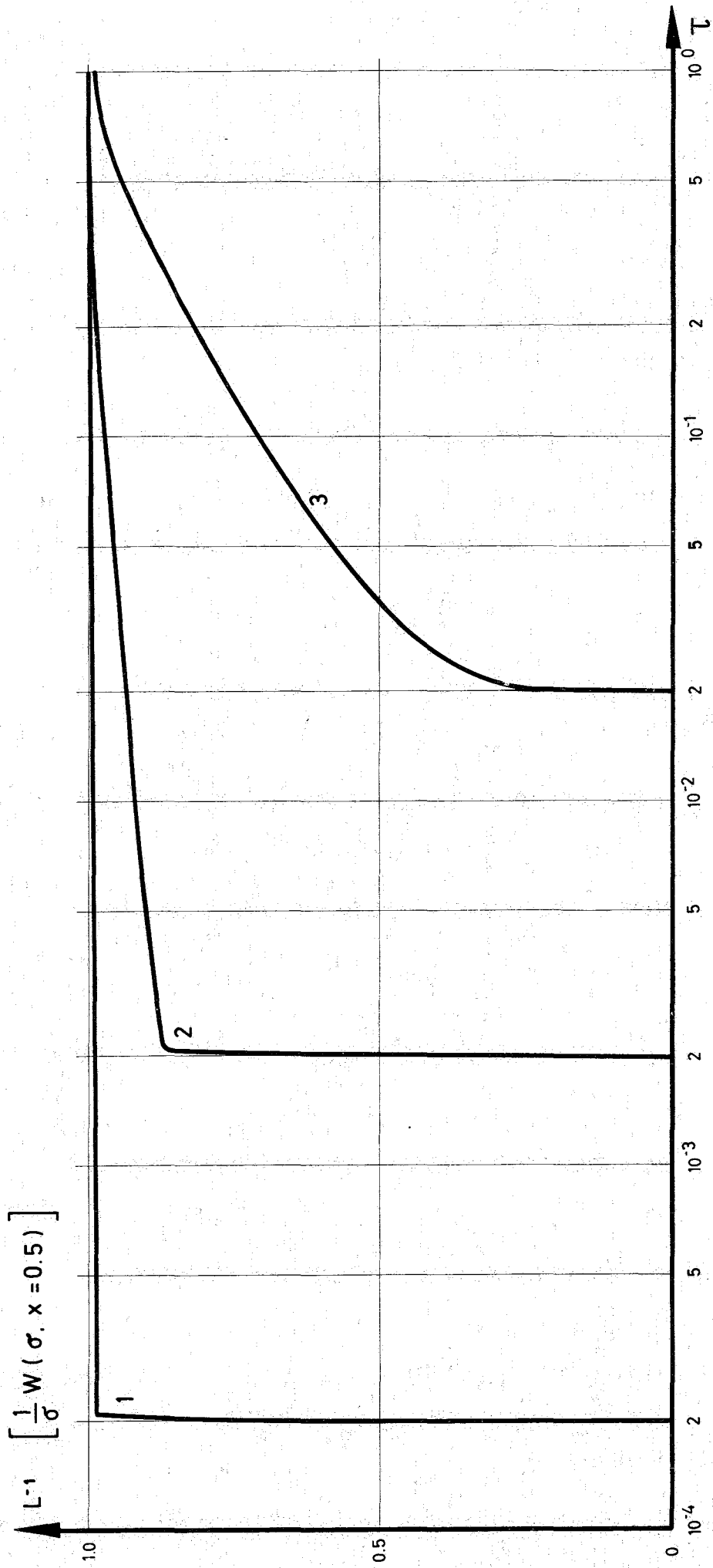

Fig. 5

curve

- 1 $m = 1.$
- 2 $m = 5.$
- 3 $m = 10.$

parameters

- $\alpha = 0.07$
- m
- $l = 0.002$

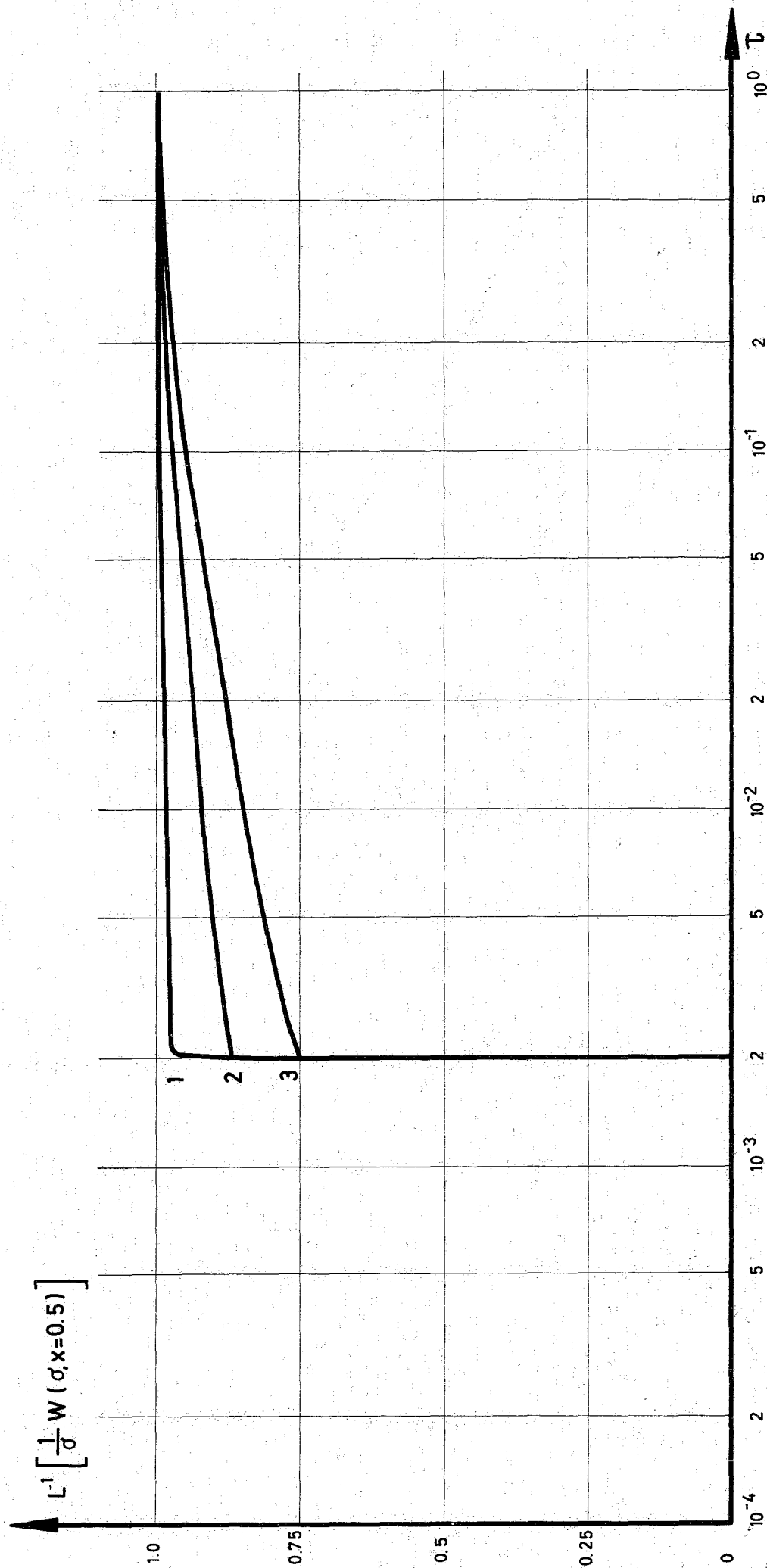

Fig. 6

curve	parameters
1	$\gamma = 1$
2	$\gamma = 0.07$
3	$\gamma = 0.01$

$m = 5$
 $l = 0.002$

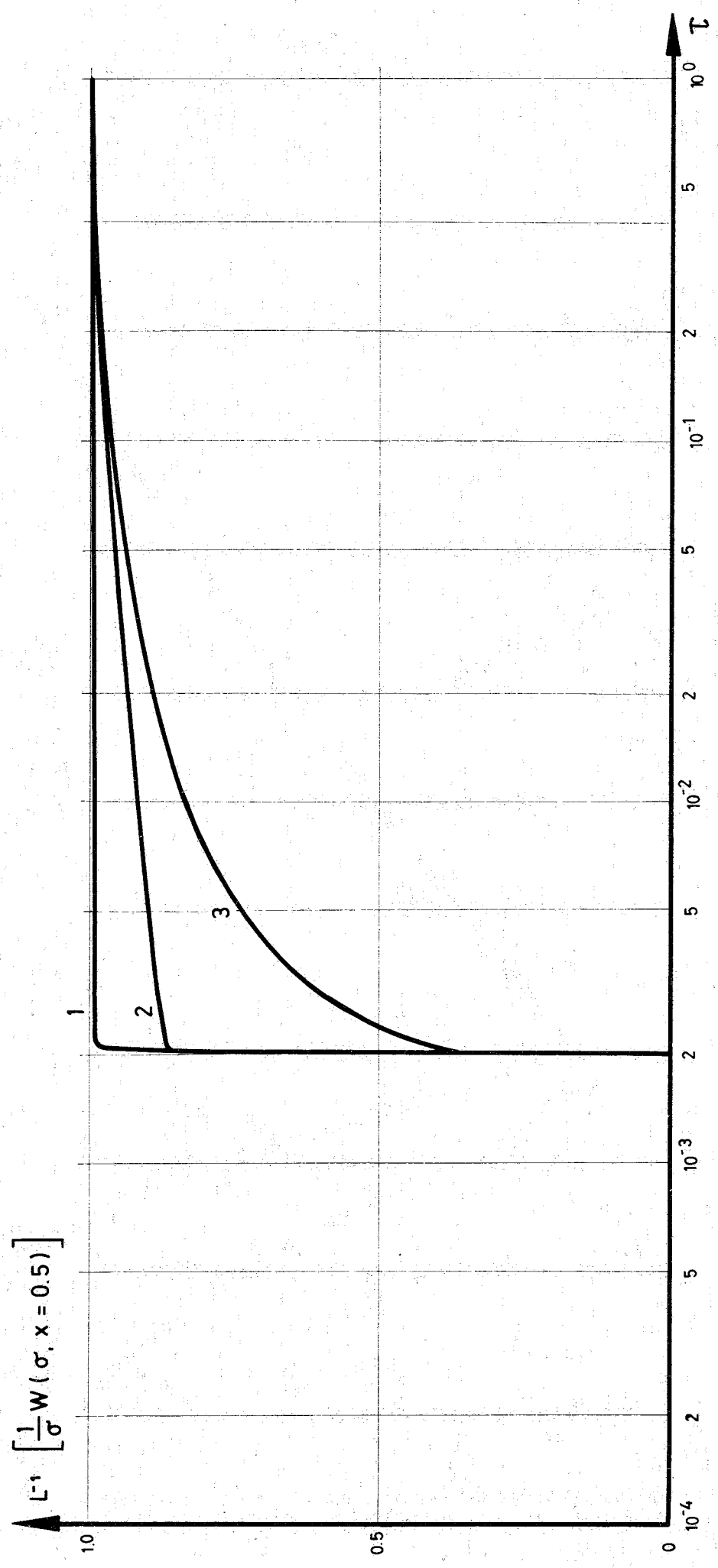

Fig. 7

parameters

$$\gamma = 0.07$$

$$m = 5.$$

$$l = 0.002$$

$$\alpha = 3.14$$

curve 1 $f(\sigma) = \bar{V}(\sigma)$

curve 2 $f(\sigma) = V(\sigma, x=0.5)$

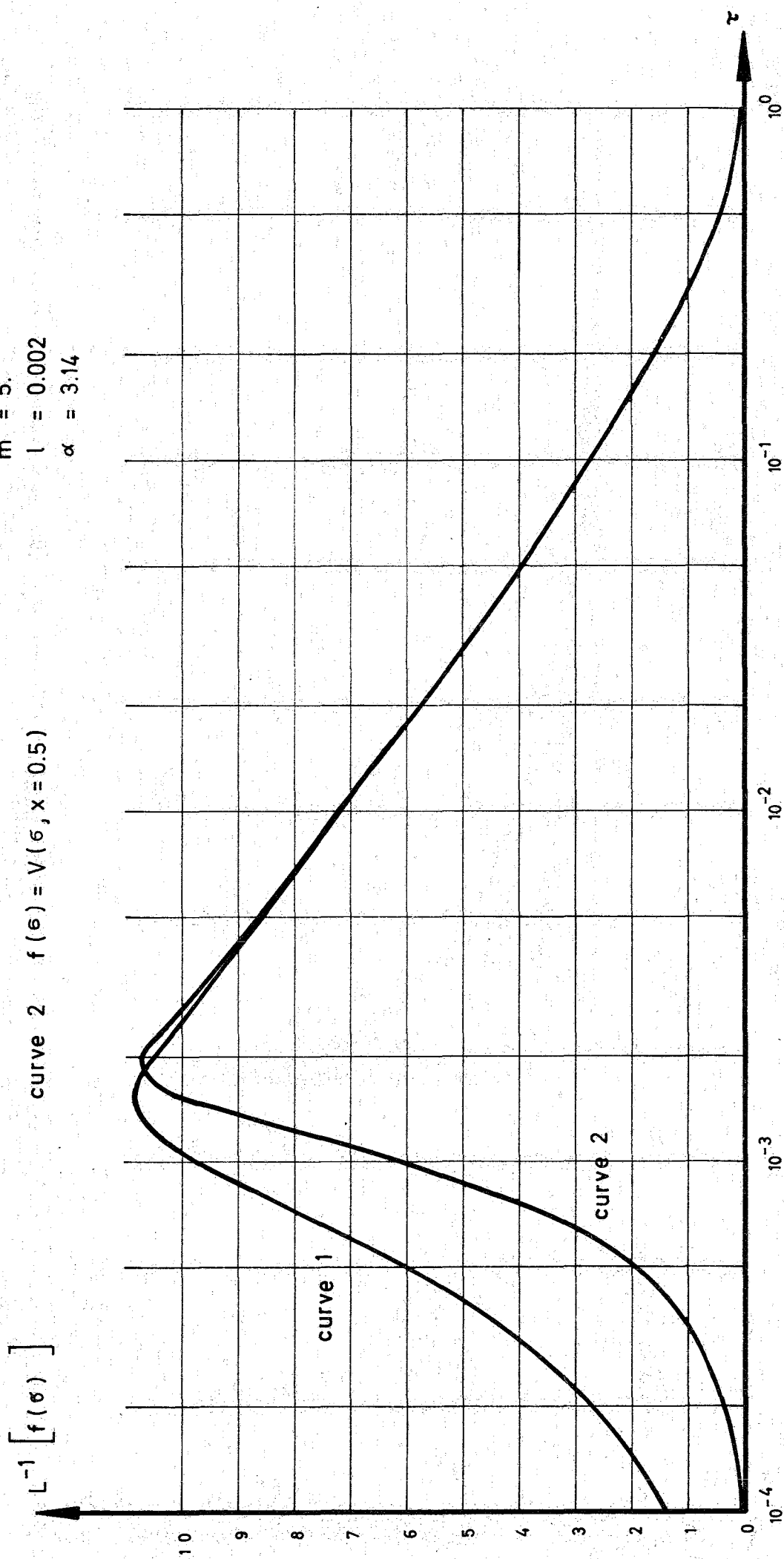

Fig. 8

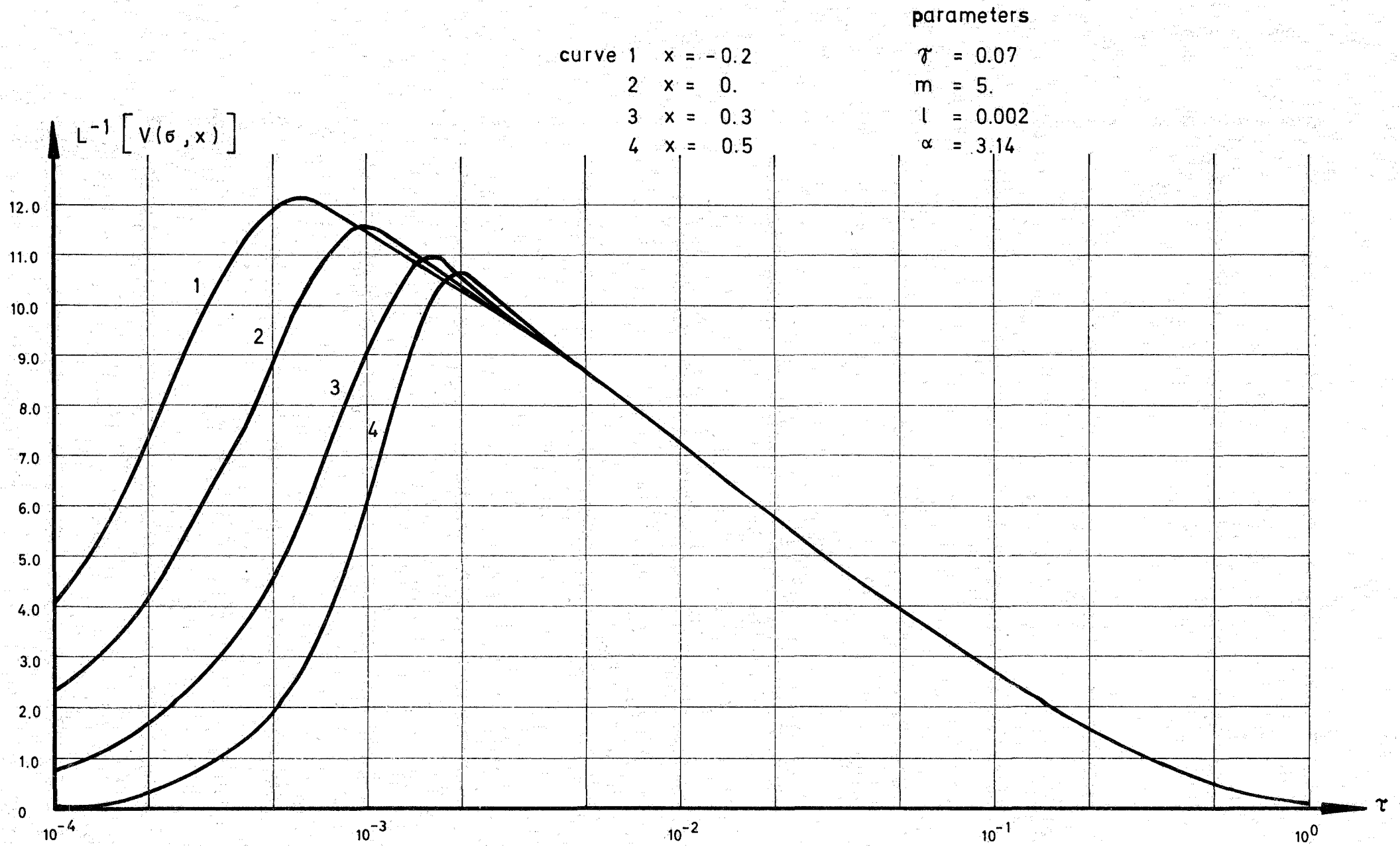

Fig. 9

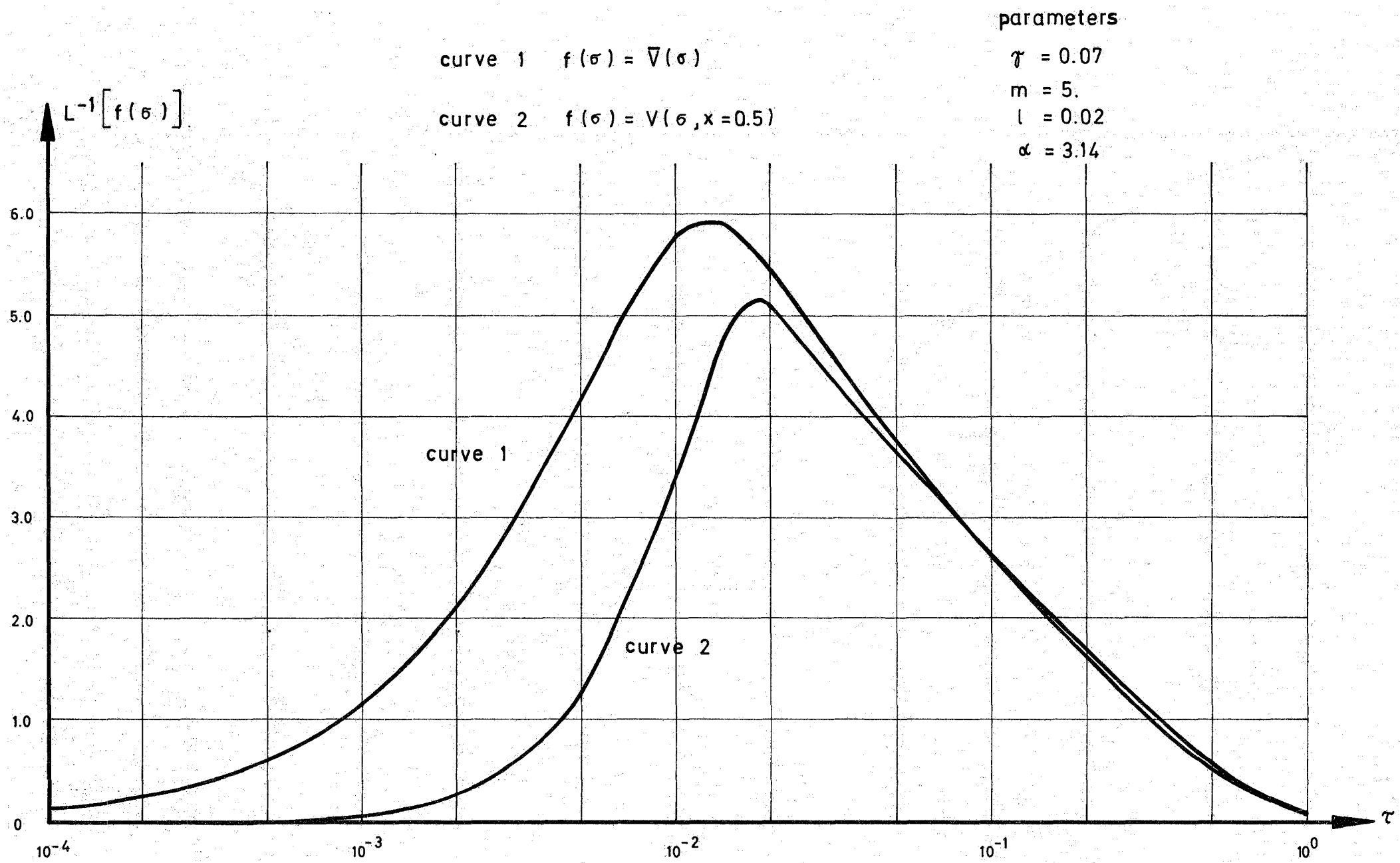

Fig. 10

parameters
 $\gamma = 0.07$
 $m = 5$
 $\alpha = 3.14$

curve
 $l = 0.0002$
 $l = 0.002$
 $l = 0.02$

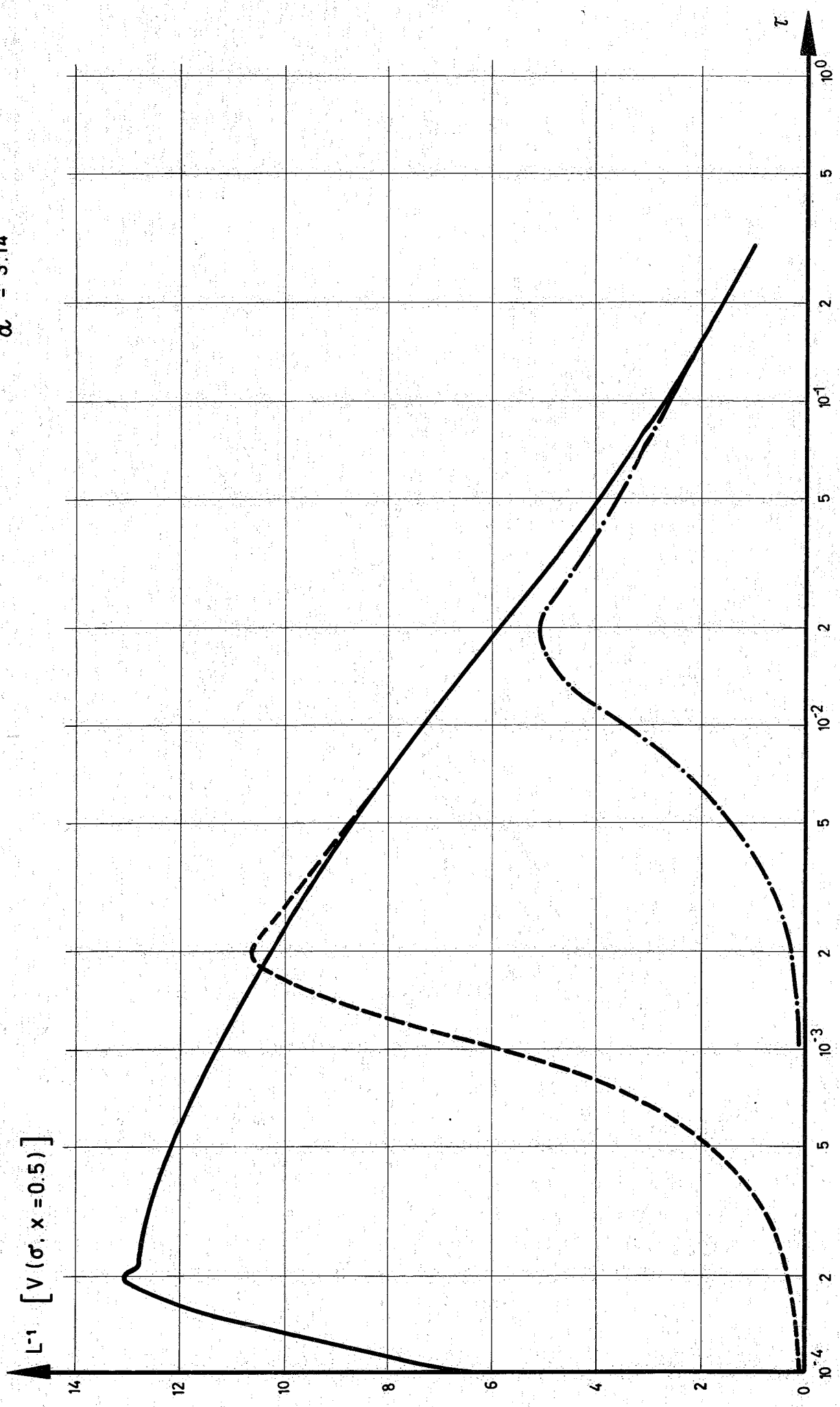

Fig. 11

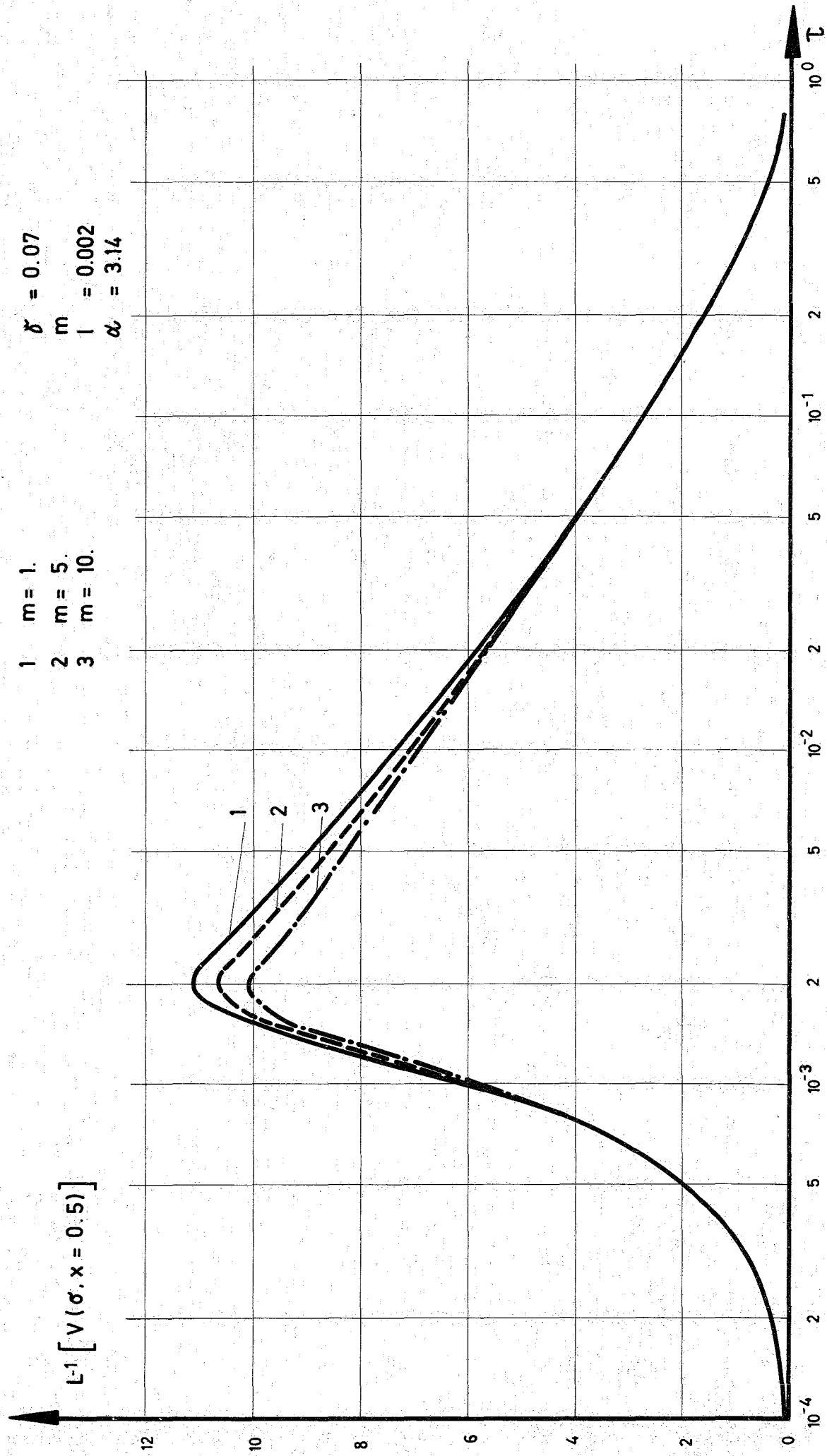

Fig. 12

parameters

γ
 $m = 5$
 $l = 0.002$
 $\alpha = 3.14$

curve

1 $\gamma = 0.01$
2 $\gamma = 0.07$
3 $\gamma = 1$

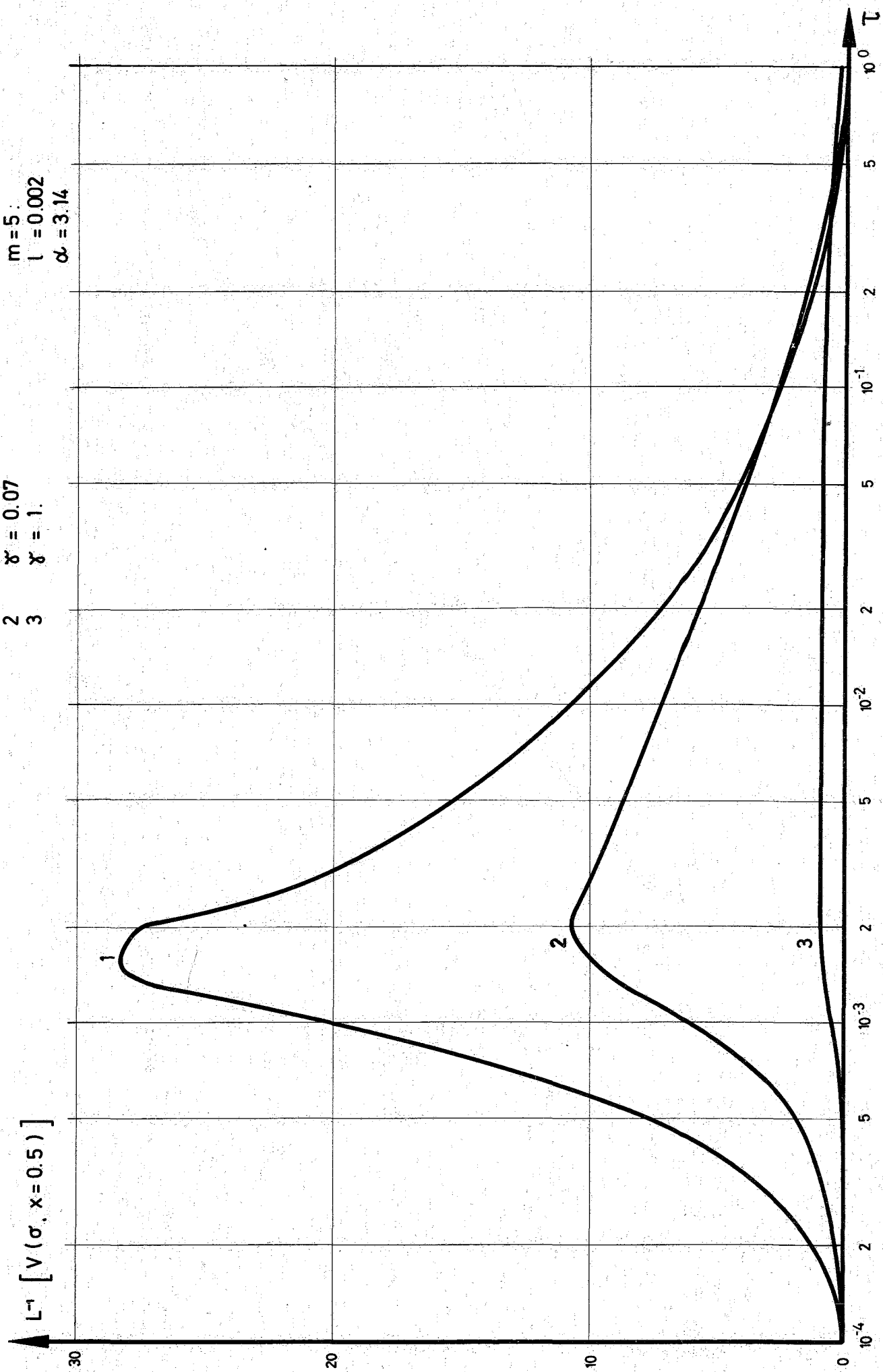

Fig. 13

curve
 — $\alpha = 3.14$
 - - - $\alpha = 0.02$

parameters
 $\gamma = 0.07$
 $m = 5$
 $l = 0.002$
 α

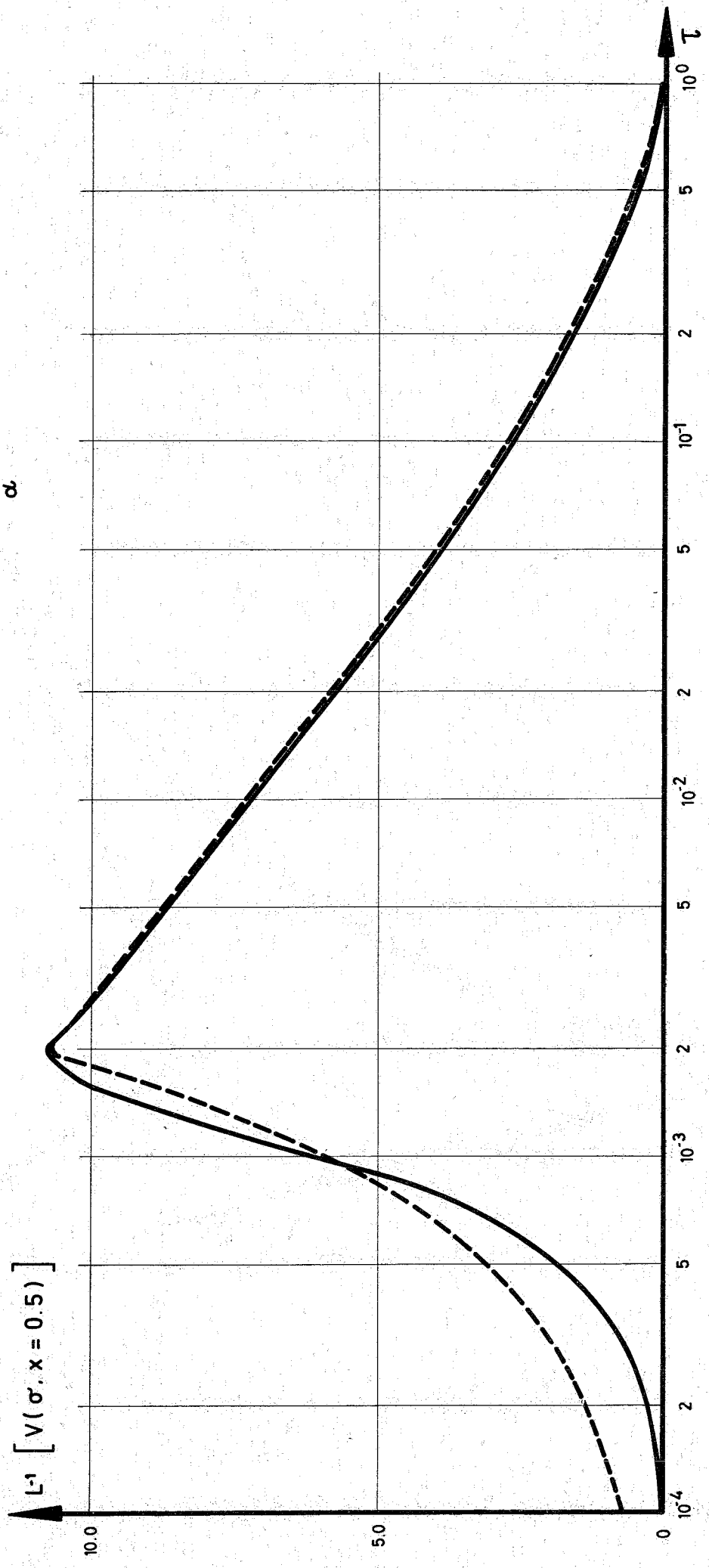

Fig. 14

approximation with

- 2 poles
- - - 4 poles
- 6 poles
- - - 20 poles

parameters

- $\gamma = 0.07$
- $m = 5$
- $l = 0.002$

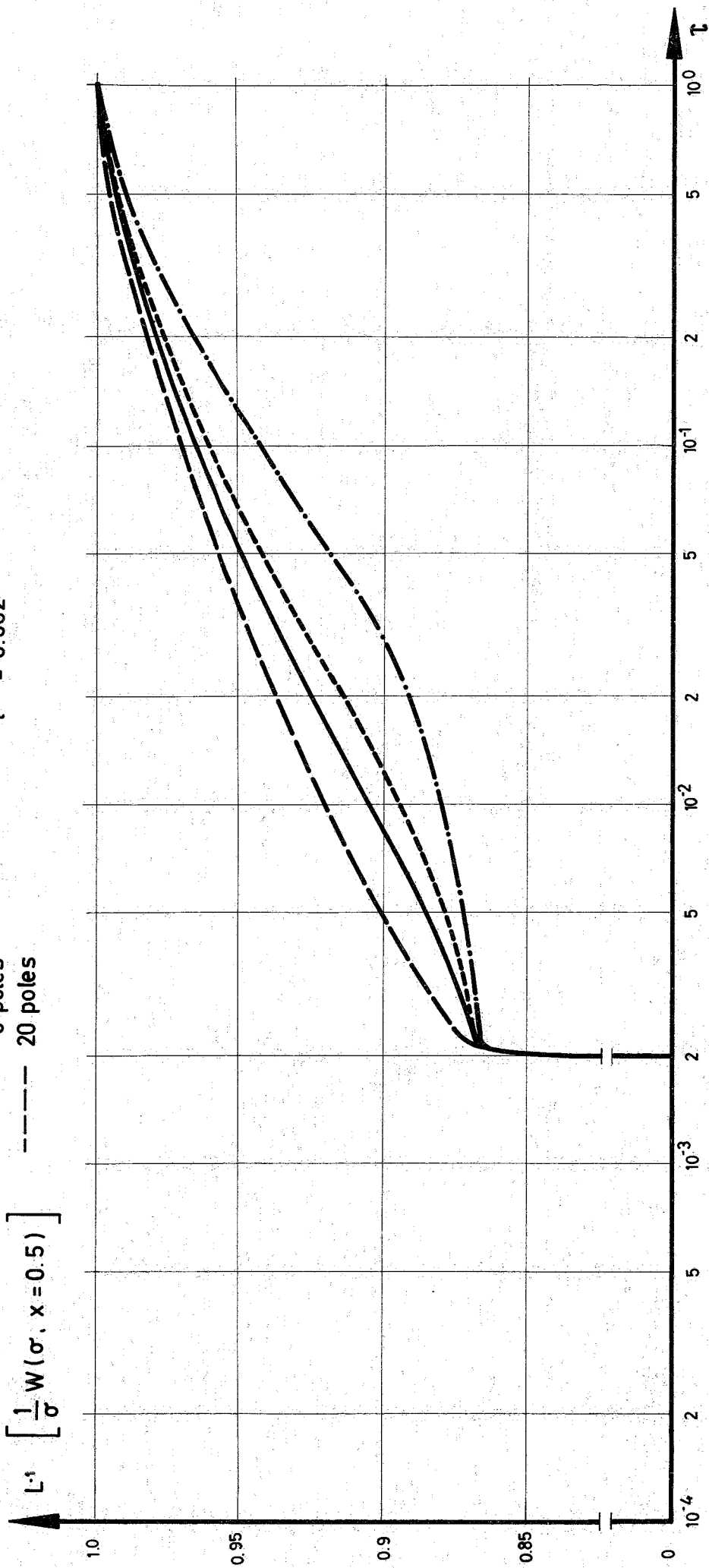

Fig. 15

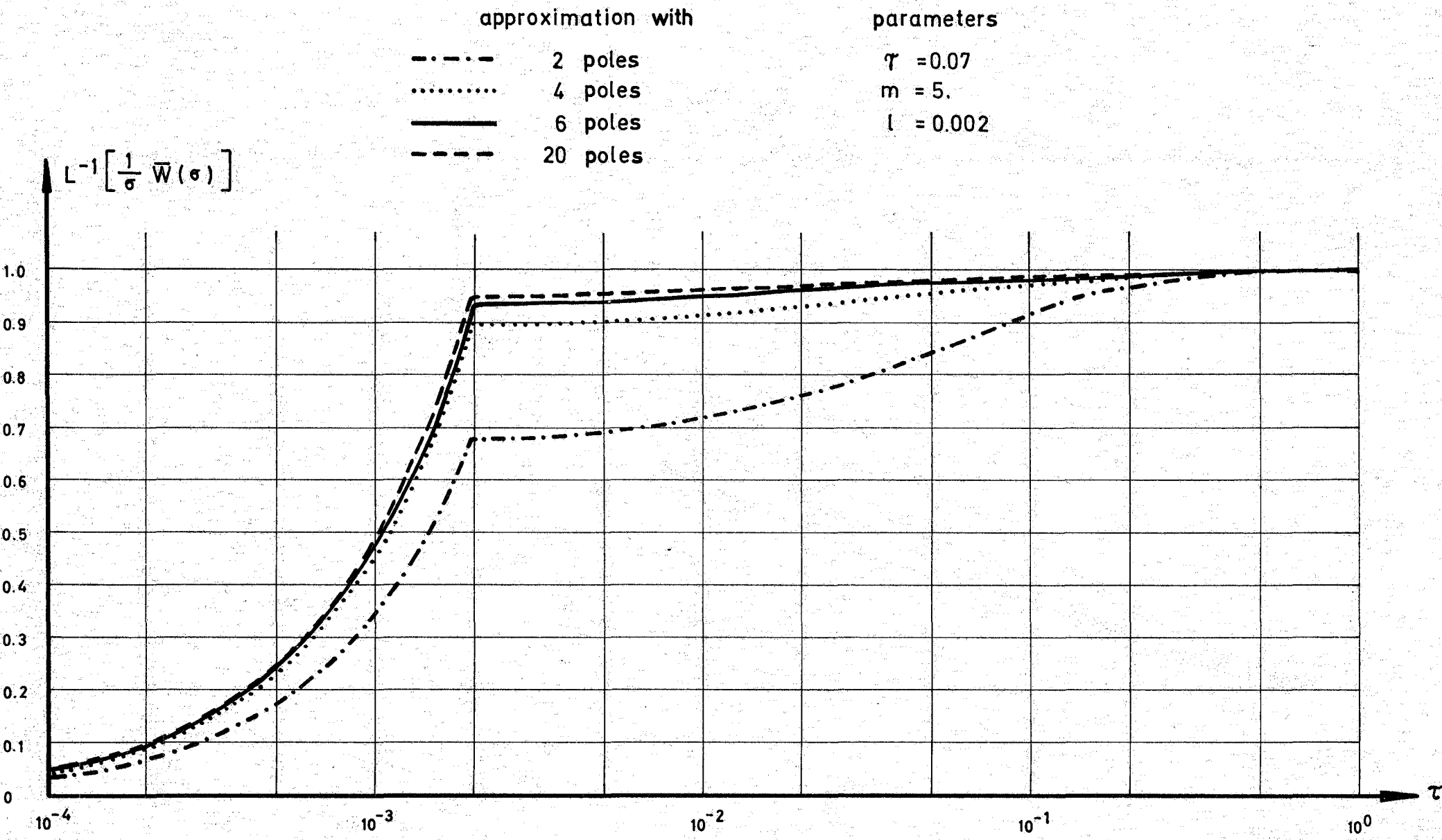

Fig. 16

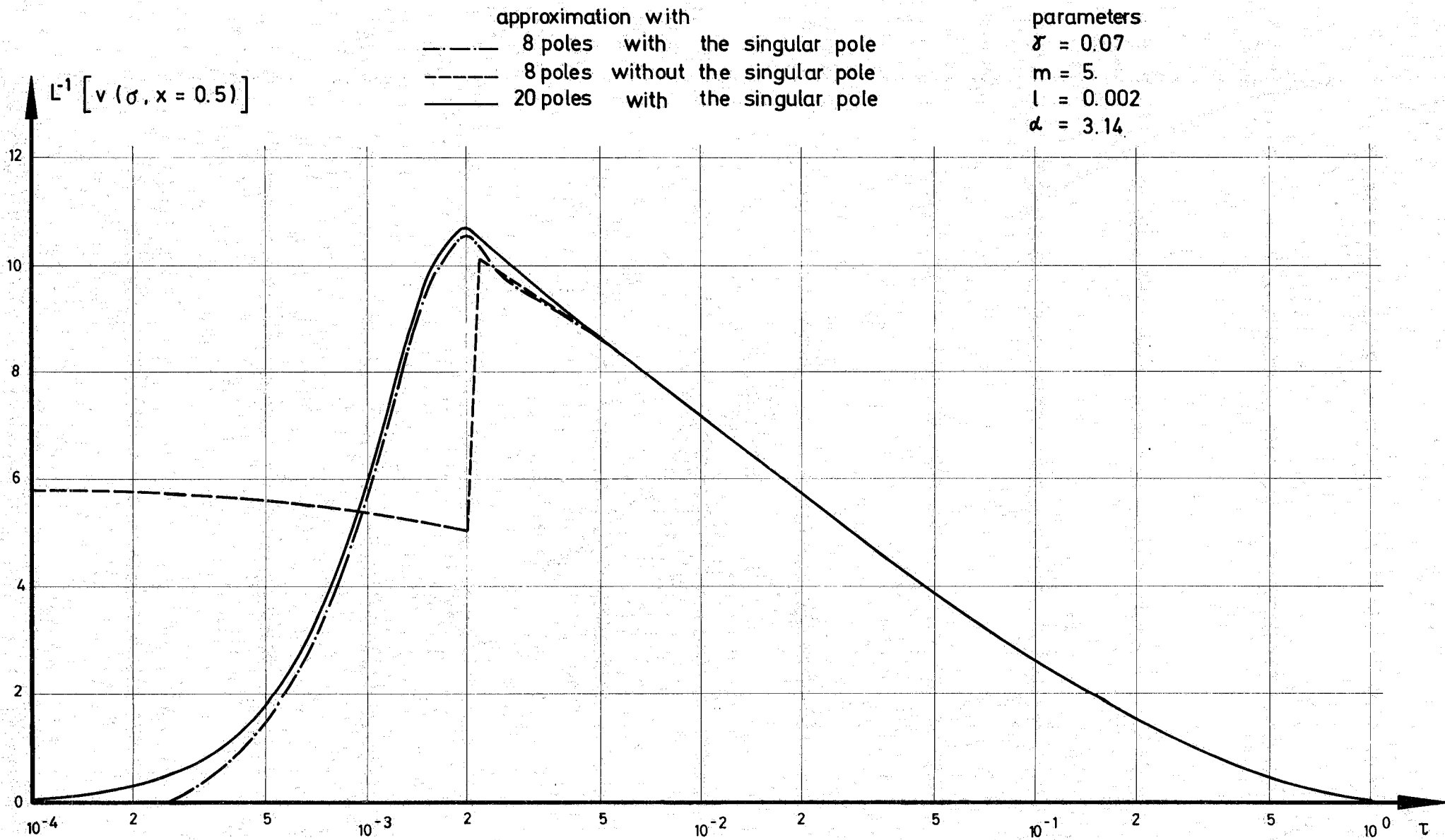

Fig. 17

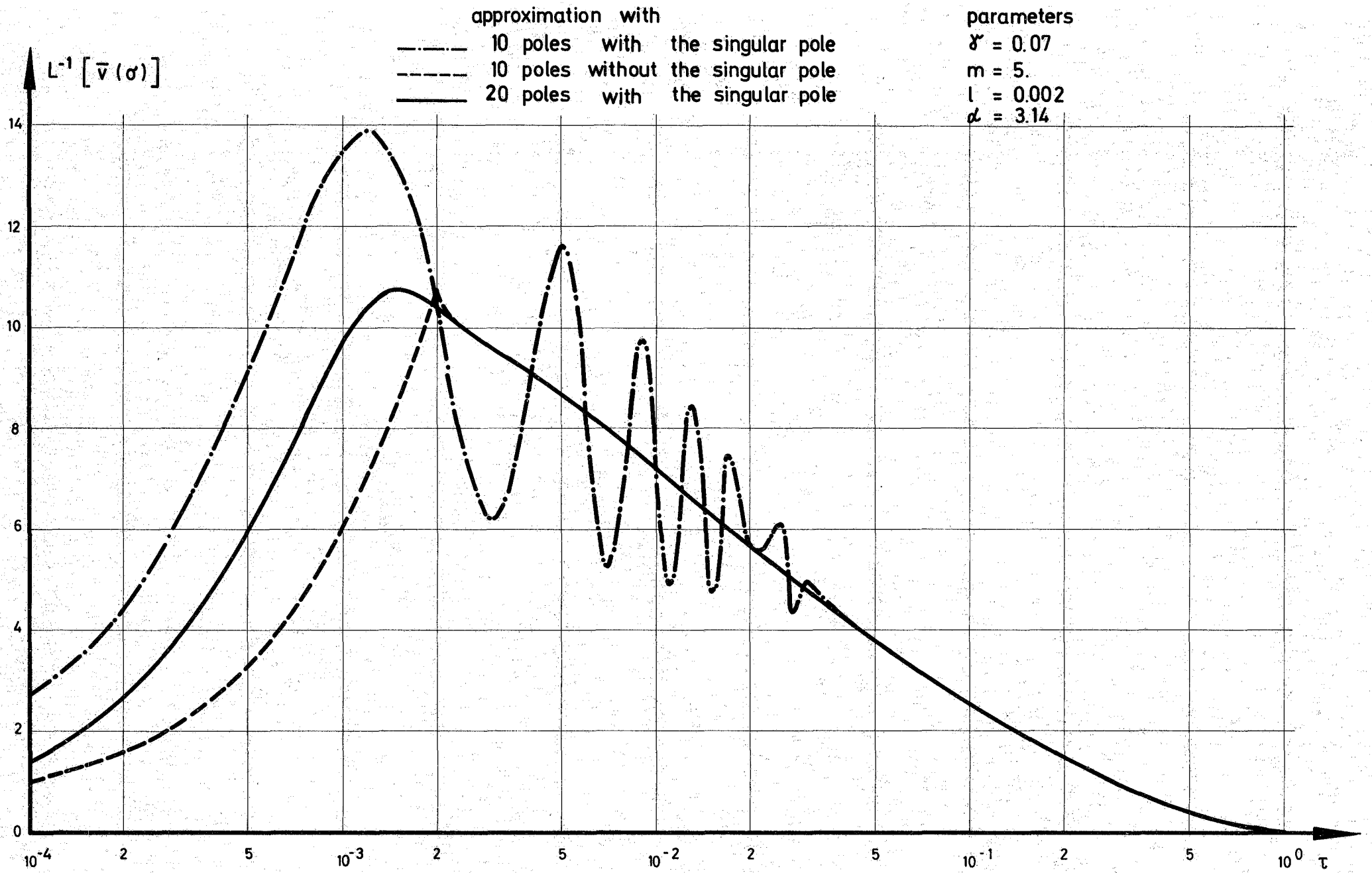

Fig. 18

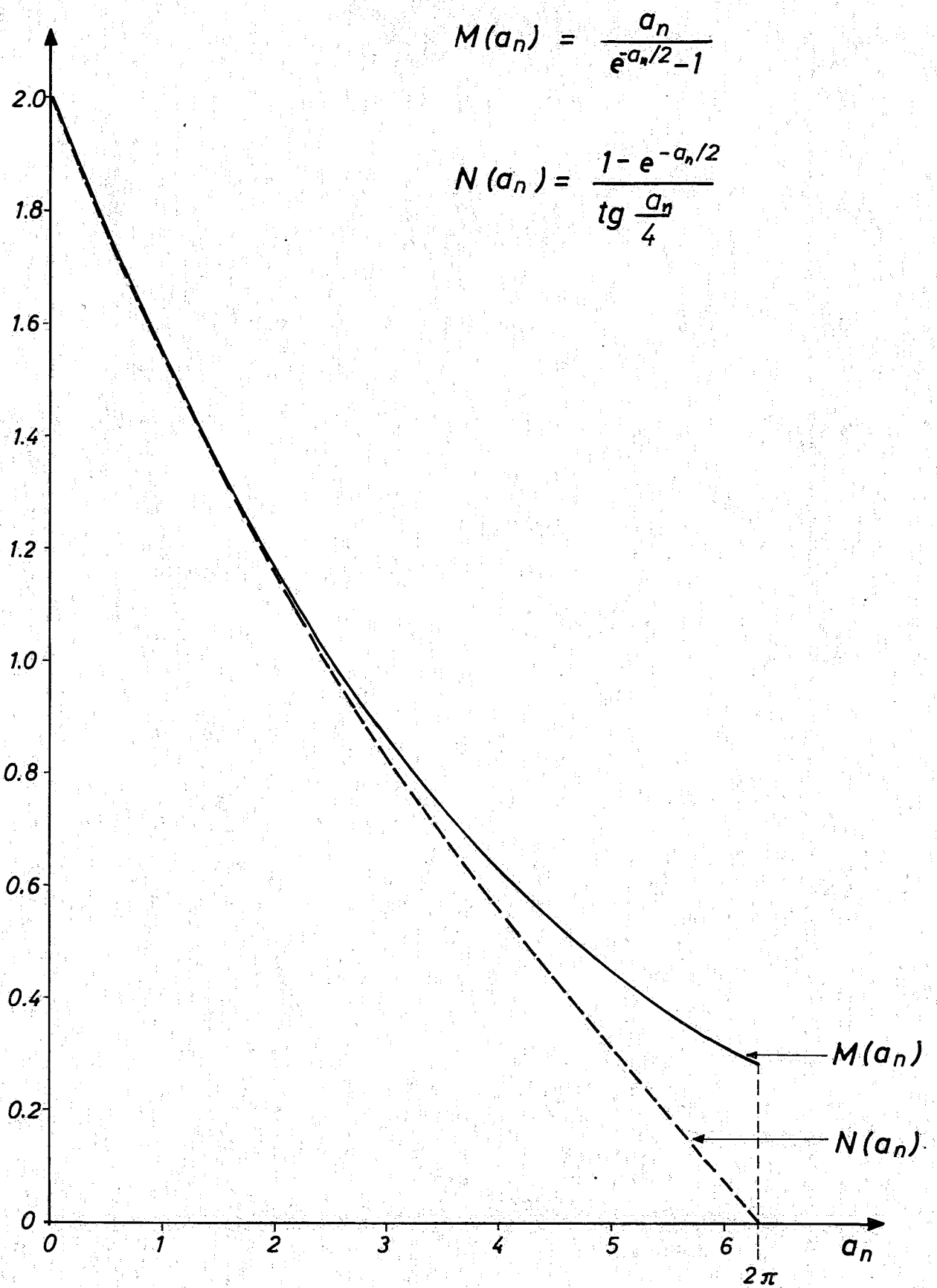

Fig. 19

$$M(a_n) = \frac{a_n}{e^{-a_n/2} - 1}$$

$$N(a_n) = \frac{1 - e^{-a_n/2}}{\operatorname{tg} \frac{a_n}{4}}$$

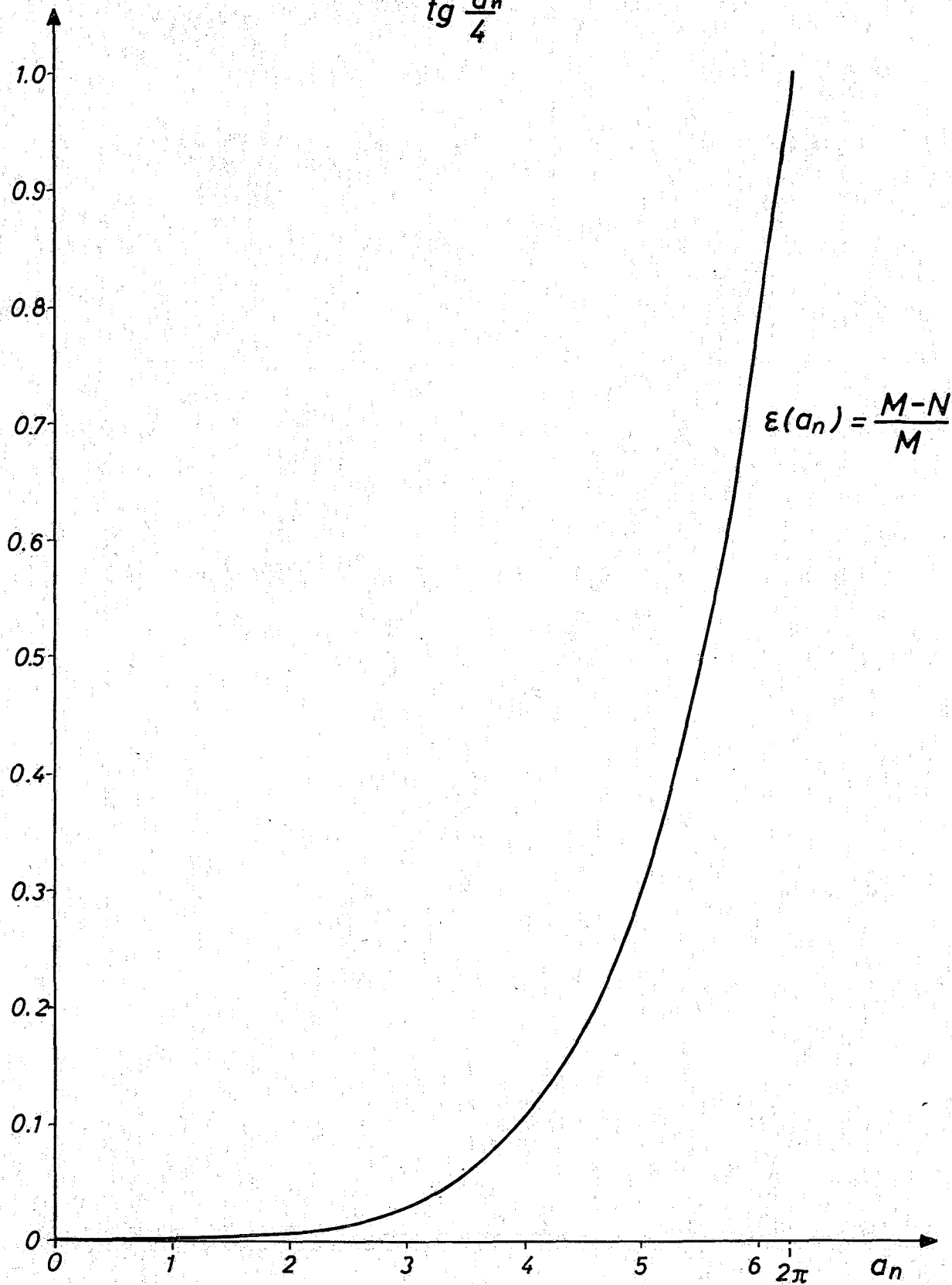

Fig. 20

$a_n = 3$
— $|f(x)|$
- - - $|g(x)|$

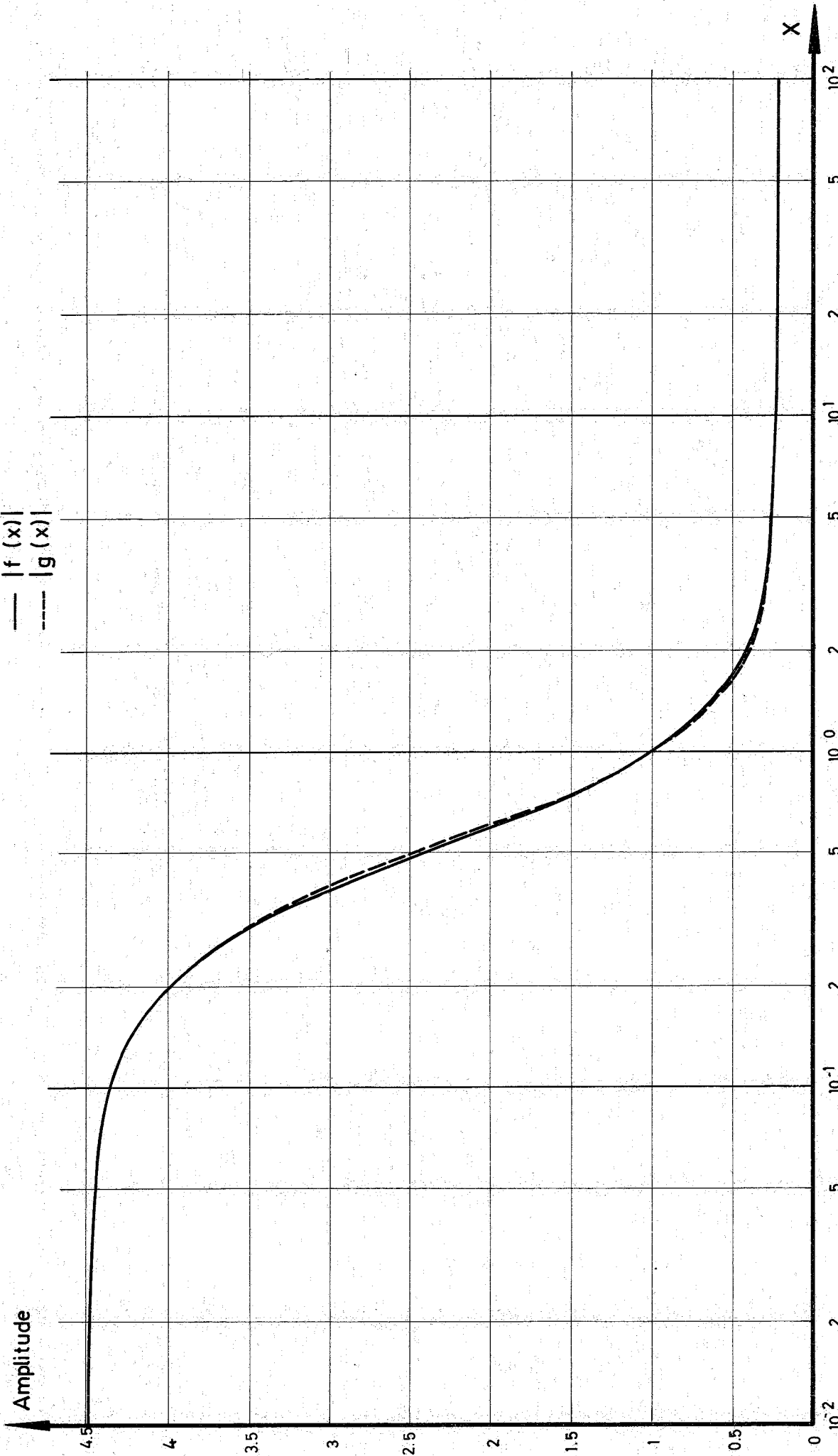

Fig. 21

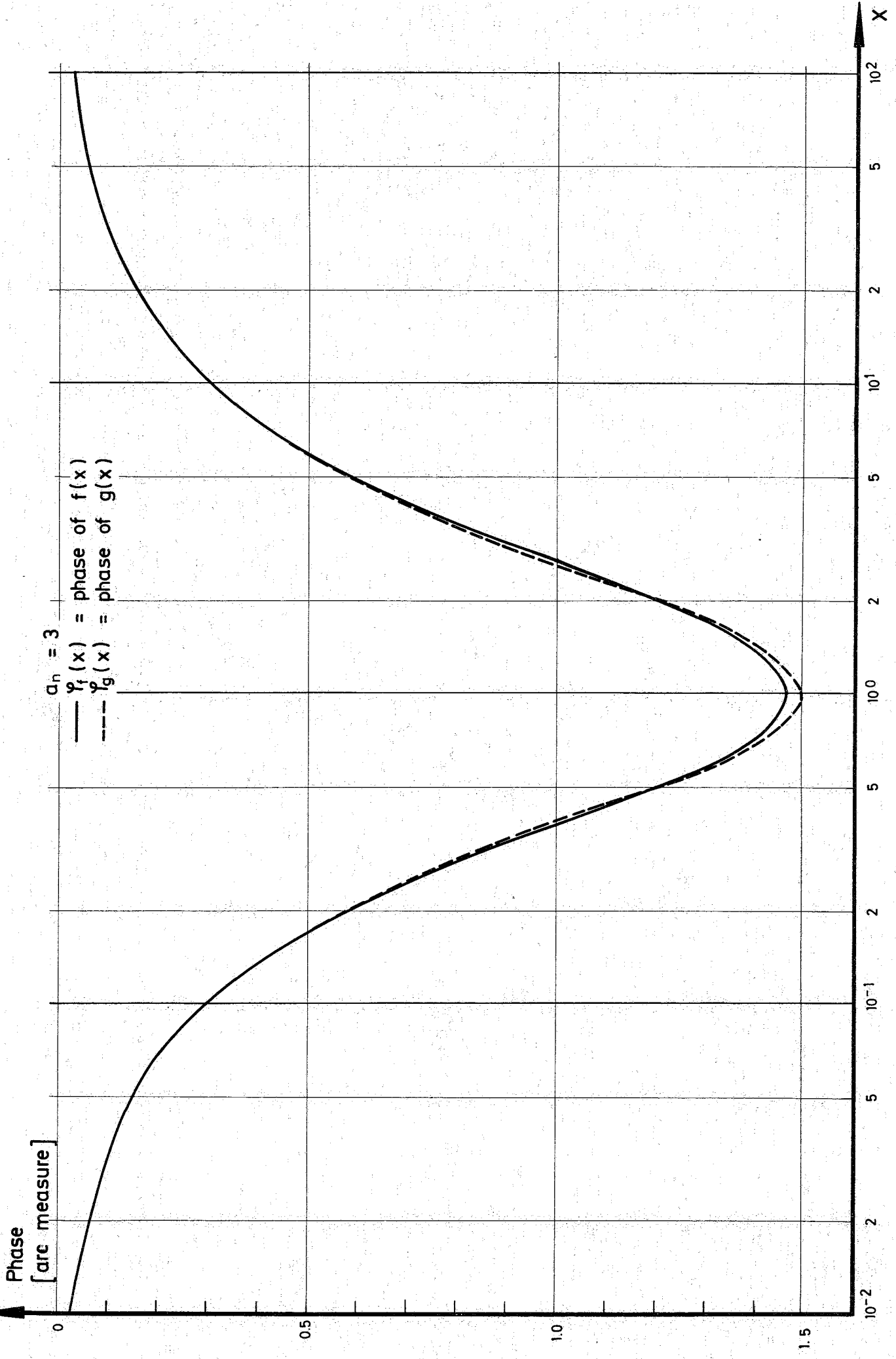

Fig. 22

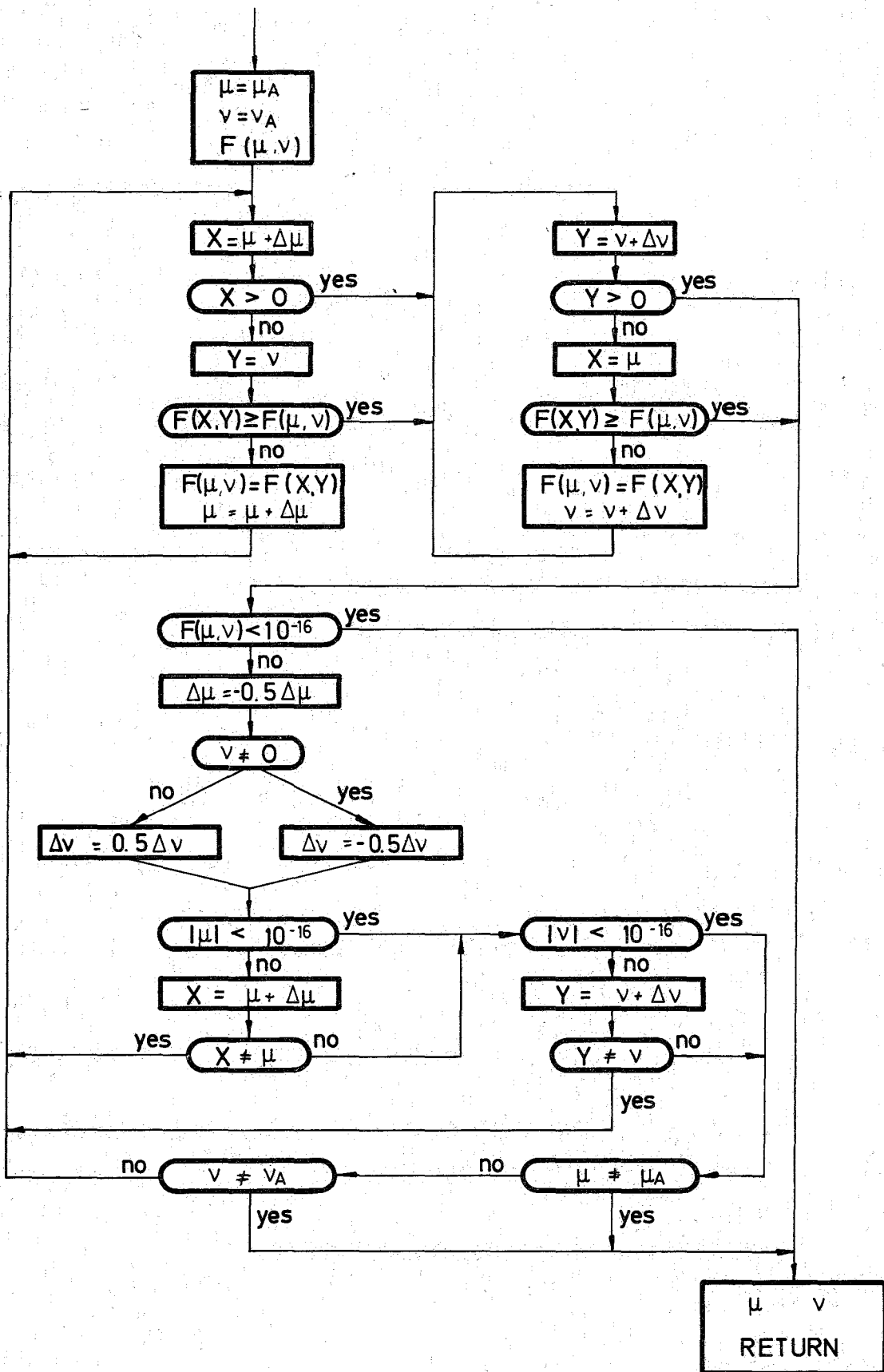

Fig. 23