

**KERNFORSCHUNGSZENTRUM
KARLSRUHE**

August 1974

KFK 1109

Institut für Angewandte Systemtechnik und Reaktorphysik
Projekt Spaltstoffflußkontrolle

Optimization of Safeguards Effort

R. Avenhaus
H. Frick
D. Gupta
G. Hartmann
N. Nakicenovic

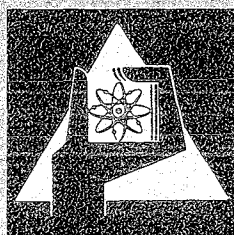

GESELLSCHAFT
FÜR
KERNFORSCHUNG M.B.H.

KARLSRUHE

KERNFORSCHUNGSZENTRUM KARLSRUHE

Institut für Angewandte Systemtechnik und Reaktorphysik

Projekt Spaltstoffflußkontrolle

KFK 1109

OPTIMIZATION OF SAFEGUARDS EFFORT

by

R. Avenhaus, H. Frick, D. Gupta, G. Hartmann, N. Nakicenovic

Gesellschaft für Kernforschung mbH., Karlsruhe

This research has been carried out in the framework of a contract between the International Atomic Energy Agency (IAEA) and the Gesellschaft für Kernforschung mbH., Institut für Angewandte Systemtechnik und Reaktorphysik, Karlsruhe, Federal Republic of Germany. The Agency contributed also financially to this work.

Summary: **Optimization of Safeguards Effort**

This report was prepared within the framework of a research contract with the International Atomic Energy Agency (IAEA) in Vienna.

It contains the preparation and the mathematical treatment of an inspection model as well as a detailed application of the theoretical considerations to a reprocessing plant of the NFS type and a fabrication plant of the ALKEM type.

In the theoretical part two possible means of diverting material are considered: diversion by means of falsification of data and diversion without falsification of data within the scope of measurement accuracy. In the first case two different statistical models are examined. The first provides for the inspector checking the operator's data by means of sample remeasurement. In the following report this will be called D_1 -statistics. In the second model the inspector compares the sum of his data with the sum of all measurement data reported by the operator; we shall call this D_2 -statistics. This will be applied if it is no longer possible for the inspector to check the batch after it has been measured by the operator.

Diversion without falsification of data within the scope of measurement accuracy is examined on the basis of material balance by single and double inventory.

The inspector assumes an overall probability α of the error of the first kind which is divided for the first and second inventory due to the restriction $1-\alpha = (1-\alpha_1) \cdot (1-\alpha_2)$. We assume that the operator diverts the amount M_1 in the first and the amount M_2 in the second inventory period under the restriction $M = M_1 + M_2$.

In one instance that is important because of its relevance to practical application it can be shown that the optimal inspector strategie (α_1^0, α_2^0) is independent of the amount M .

In chapter III we work out numerical examples using the reference plants data described in chapter II. The examples are meant to demonstrate the possibilities and restrictions of the methods developed in chapter I. This is achieved with the help of extensive parameter variations. The report closes with a summary of the most important results and a reference to fields of research where future work could be of use.

zum Druck eingereicht 11.7.1974

Der vorliegende Bericht wurde im Rahmen eines Forschungsauftrages mit der International Atomic Energy Agency (IAEA) in Wien angefertigt. Er enthält die Aufstellung und die mathematische Behandlung eines Inspektionsmodells sowie eine ausführliche Anwendung der theoretischen Überlegungen auf eine Wiederaufbereitungsanlage vom Typ der NFS und eine Fabrikationsanlage vom ALKEM Typ.

Im theoretischen Teil werden 2 Arten von Materialentwendung berücksichtigt, Entwendung mittels Datenverfälschung und Entwendung ohne Datenverfälschung im Rahmen der Meßgenauigkeit. Im ersten Falle werden zwei verschiedene statistische Modelle betrachtet. Das erste sieht eine Kontrolle der Betreiberdaten durch Nachmessen von Stichproben seitens des Inspektors vor. Es wird im folgenden mit D_1 -Statistik bezeichnet werden. Im zweiten Modell vergleicht der Inspektor die Summe seiner Daten mit der Summe aller vom Betreiber berichteten Meßdaten, wir werden es D_2 -Statistik nennen. Es wird dann verwendet, wenn nach erfolgter Betreibermessung eine Kontrolle des Batches durch den Inspektor nicht mehr möglich ist.

Die Entwendung ohne Datenverfälschung im Rahmen der Meßgenauigkeit wird anhand der Materialbilanz bei der einfachen und zweifachen Inventur betrachtet. Der Inspektor gibt sich eine Gesamtfehlalarmwahrscheinlichkeit α vor, die sich für die erste und zweite Inventur vermöge der Nebenbedingung $1 - \alpha = (1 - \alpha_1)(1 - \alpha_2)$ aufteilt. Es wird angenommen, der Betreiber entwendet in der ersten Inventurperiode die Menge M_1 , in der zweiten die Menge M_2 unter der Nebenbedingung $M = M_1 + M_2$. In einem für die Praxis wichtigen Fall kann gezeigt werden, daß die optimale Inspektorstrategie (α_1^0, α_2^0) unabhängig von der Größe von M ist.

In Kapitel III werden numerische Beispiele mit den Daten der in Kapitel VI beschriebenen Referenzanlagen gerechnet. Diese Beispiele sollen die Möglichkeiten und Beschränkungen der in Kapitel I entwickelten Methoden aufzeigen. Dies wird durch umfangreiche Parametervariationen erreicht. Der Bericht endet mit einer Zusammenfassung der wichtigen Ergebnisse und einem Ausblick auf die Gebiete, wo weitere Forschungsarbeiten nützlich sein könnten.

Table of the Authors

Introduction D. Gupta

Chapter I R. Avenhaus, H. Frick, N. Nakićenović

Chapter II R. Avenhaus, G. Hartmann

Chapter III H. Frick, G. Hartmann

Conclusions D. Gupta

<u>Table of Content</u>		<u>Page</u>
General Introduction		1
Chapter I	Theoretical Consideration on the Verification of Material Accountancy by Means of Random Sampling	4
	1. Introduction	
	2. Verification of the Material Balance	
	3. Verification of Data	
	4. Conclusions	
	5. References and Figures	
Chapter II	Data Collection for the Reference Plants	47
	1. Data of the NFS Reprocessing Plant	47
	1.1 Plant Data	
	1.2 Measurement System, Method and Sampling Points	
	1.3 Safeguards Effort	
	1.4 Tables, Figures and References	
	2. Data of the ALKEM Fabrication Plant	63
	2.1 Description of the Plant	
	2.2 Flow, Handling and Location of Nuclear Material	
	2.3 Flow Measurements	
	2.4 Inventory Taking	
	2.5 Tables and Figures	
Chapter III	Optimal Allocation of Safeguards Effort and Parameter Studies	76
	1. Introduction	
	2. Application on NFS	
	3. Application on ALKEM	
	4. Tables and Figures	
Conclusions		106

OPTIMIZATION OF SAFEGUARDS EFFORT

by

R. Avenhaus, H. Frick, D. Gupta, G. Hartmann, N. Nakicenovic
Institut für Angewandte Systemtechnik und Reaktorphysik

Kernforschungszentrum Karlsruhe

Introduction

After the basic features of an international system for safeguarding the fissionable material were laid down in the IAEA document INFCIRC/153 in 1971, the factors influencing the efficiency of such a system became fairly well defined. The problem of optimization of safeguards efforts for such a system could then be expected to be defined in tangible terms and the problem treated in a formalized manner.

An analysis of the components influencing the safeguards system in terms of INFCIRC/153 revealed quite early that the optimization of safeguards effort involves complex relationships between the measurement systems and the operational mode of specific facilities, safeguards inspection activities needed to verify the status of nuclear materials in these facilities, the amounts and costs of inspection efforts required and the effectiveness of the results of inspection in arriving at a technical conclusion of the amount of material unaccounted for over a specific period, giving the limits of accuracy of the amounts stated. It was also recognized that statistical and mathematical methods for relating the complex activities would be an important tool for the determination of the steps needed to improve the overall efficiency of the safeguards system, particularly insofar as management decisions are involved.

The use of decision theoretical methods for the analyses of the efficiency of international safeguards systems has been a subject matter of investigation at the Safeguards Project Karlsruhe, Atomic Research Center, since 1968. Already at that time it had become clear that the use of conventional measurement and sampling statistics was not sufficient in this specific field. The inspection authority has not only to do with the objective nature which generates errors according to a random law but with human beings which may purposely choose - if they want so - among different modes of diversion. However, it appeared to be a great obstacle for the

application of decision theoretical methods that payoff parameters for the gain and the loss of the operator in case of detected and undetected diversion had to be defined. It was not possible to get a common opinion about the values of these payoff parameters. Only after it was found that for the question of the optimal allocation of a given inspection effort the values of the payoff parameters must not be known that the great value of the theory was recognized.

In the framework of the present contract with the Agency, the project was requested to analyse the possibility of using game theoretical methods for optimizing safeguards efforts in nuclear facilities. Besides purely theoretical and model considerations, the practical use of such methods was to be shown with the help of two examples one for a reprocessing and the other for a Pu-fabrication plant.

The present report contains the results of this analysis.

In chapter I, the basic framework and the boundary conditions for the use of game theoretical methods in optimizing safeguards efforts have been fixed. The mathematical formalism for the optimization has then been developed indicating the areas of its application as also its limitations. A comparison with another method (Stewart) which is not based on game theory, has also been made using a specific numerical example. The chapter ends with a set of conclusions.

Chapter II contains all the relevant plant and safeguards data required to illustrate the application of methods developed in chapter I. The data used for a reprocessing plant correspond to those of the NFS-plant. The plant specific data were mainly obtained from published literature and corroborated by the representatives of the IAEA. Data on safeguards specific activities (inspection manhours for specific safeguards activities, measurement times etc.) were mostly obtained from the specialists on Reprocessing Plants at the IAEA.

The data used for Pu-fabrication are typical of an Alkem-type-plant. They are not of the Alkem plant. The Alkem plant is not yet in operation. However, to obtain as realistic a set of data as possible, these data were laid down after detailed discussions with the Alkem plant management and operation staff.

In chapter III numerical examples with parameter variations for the two reference plants have been given. The parameters varied are the errors first and second kind, the overall costs for safeguards (sample analysis and manhour costs) and the amounts of fissionable material assumed to be diverted. For all these parameter variations, the number of inventory takings per year has always been kept at two.

The influence of other safeguards measures like sealing, use of correlations and shipper-receiver differences have not been analysed explicitly in this report as otherwise, the basic purpose of this work, namely to investigate the implications and usefulness of game theoretical methods would not have come out very explicitly. However, some of these redundant measures have been built in implicitly in the estimations of the basic safeguards effort in a plant (e.g. sealing).

The main purpose of the numerical examples in this chapter is to illustrate the application and the limitations of the methods developed in chapter I. The actual numbers obtained or used should in no way prejudice the safeguards activities in an actually operating facility. For example, the actual number and type of batches, or the measurement accuracies may have totally different values in such a facility.

The report ends with a chapter on conclusion. It includes a summary of the important conclusions drawn in individual chapters and a discussion of the areas in which further research activities might appear to be desirable.

Chapter I Theoretical Considerations on the Verification of Material Accountancy by Means of Random Sampling

1. Introduction

According to the IAEA model agreement /1/ safeguards is based mainly on the concept of the verification of the material balance in a nuclear plant for a given period of time. This means that the operator of the plant takes all the measures necessary for the establishment of the book inventory over a certain period of time and furthermore, for the establishment of the physical inventory at the end of that period of time and that he reports these data to the safeguards authority. An inspector of the safeguards authority checks these data on a random sampling basis with the help of independent measurements. If he has found no significant differences between the operator's reported values and his own corresponding findings he takes all the data of the operator and tries to close the material balance, i.e. he checks whether or not there is a significant difference between the book and the physical inventory at the end of the inventory period.

An analysis of the efficiency of this verification scheme has to take into account two principle possibilities for the operator to divert nuclear material:.

- (i) The operator falsifies his reported data in such a way that the material balance is closed even though some material has been removed
- (ii) The operator simply removes material without any falsification of data; he hopes that the uncertainty of the material balance (mainly caused by the uncertainty of the measurements) will cover such a diversion.

One has to realize that the first diversion strategy exists only because of the special verification scheme adopted by the safeguards authority. If e.g. the inspector would not use the operator's data but try to close the material balance only with the help of his own data there would be no sense for the operator to falsify data. Additionally, it should be realized that this procedure refers only to the detection of a diversion of declared material, i.e. material which enters the plant in a declared way. The detection of the misuse of the plant is not an objective of the verification scheme described above.

As a consequence of these considerations, the analysis will consist of two main parts

- (i) The analysis of the data verification problem. Here, the question of the optimal allocation of inspection effort to different classes of material is central.
- (ii) The analysis of the material balance problem. As the question of the allocation of the inspector's effort is more important in the case of data verification, here the question of the appropriate significance threshold is central. Effort questions come into the picture in form of boundaries: Number of inventories per year, quality of measurements, number of repeated measurements, frequency of calibrations.

In the following treatment the second case will be treated first. One could argue that the data verification problem should be treated first as only after a satisfying comparison of data the material balance will be closed with the help of the data of the operator. However, as the material balance gives the frame for the data verification procedure, this problem will be treated first. One may say that the analysis of the material balance problem alone is equivalent to the assumption that all the data are verified by the inspector ('100 % coverage'), i.e. that there exists no possibility of diverting material and covering it by appropriate data falsification.

If one takes into account data falsification strategies one has to consider two different cases:

- (i) It is possible to verify reported data of measurements some time after these data have been generated. This is e.g. the case for chemical analyses if the samples can be stored up to the end of a campaign.
- (ii) It is possible only to verify reported data immediately after they have been generated. This is the case for volume or weight determinations of batches which go into the process and therefore, lose their identity.

The respective statistical procedures have to take into consideration the fact that in case (i) one can find a falsified datum in the sample even if the sample size is smaller than 100 % whereas in case (ii) this is not possible as the operator - if he falsifies data at all - always will falsify those data which are not verified. However, also in this case there exists a possibility to detect a falsification.

In order to be able to make a statement on the guaranteed probability of detection one has to determine the minimum of the probability of detection with respect to all possible diversion strategies. On the other hand one has to determine that distribution of safeguards effort which maximizes the probability of detection. As has been discussed already earlier /2/ this procedure is equivalent to a game theoretical treatment in the framework of a two-person zero-sum game with the probability of detection as the payoff to the inspector.

Up to now it had been assumed that the overall probability of detection for the period of one year is the only criterion of optimization. However, there is also the objective of having the detection time as short as possible. As a detection of a diversion can be achieved only at the end of an inventory period, the length of the inventory period determines the detection time. For economical reasons one can have not more than two inventory periods per year in most of the plants of the nuclear fuel cycle therefore, in the following the detection time is considered to be a boundary rather than an objective which is expressed in the number of inventory periods per year.

In the following, a short description of the relevant methods and formulae will be given. The mathematical proofs will not be presented here as they have been already published elsewhere.

2. Verification of the material balance

2.1 One inventory period

In the following the time interval (t_0, t_1) is considered. At the time point t_0 a physical inventory is taken; as a result the amount I_0 of material may be found in the plant. In the interval of time (t_0, t_1) the material throughput (input minus output) may amount to the value D_1 thus, the so called book inventory B_1 at the point of time t_1 is given by

$$B_1 = I_0 + D_1 \quad (2.1)$$

At the point of time t_1 again a physical inventory is taken; as a result the amount I_1 of material may be found.

In case of no diversion of material in the interval of time (t_0, t_1) both, the book and the physical inventory should have the same value. Because of measurement errors there may be a difference thus the question arises whether or not the difference between the book and the physical inventory which is called 'Material Unaccounted For (MUF)':

$$MUF_1 := B_1 - I_1 \quad (2.2)$$

is significant. This means that a significance test has to be performed where the null hypothesis H_0 is given by the statement 'no diversion' and the alternative hypothesis H_1 by the statement 'diversion of the amount M_1 of material' (the value of M_1 will be discussed lateron).

Let $\sigma_{I_0}^2$, $\sigma_{D_1}^2$ and $\sigma_{I_1}^2$ be the variances of the random variables physical inventory at t_0 , throughput during (t_0, t_1) and physical inventory at t_1 . Then the variance of MUF is given by

$$\text{var}(MUF_1) = \sigma_{I_0}^2 + \sigma_{D_1}^2 + \sigma_{I_1}^2 = : \sigma_1^2 \quad (2.3)$$

independent of the fact whether or not a diversion will be tried. Therefore, the significance test may be defined in the following way:

$$\begin{aligned} \text{Null hypothesis:} \quad & E(\text{MUF}_1/H_0) = 0 \\ \text{Alternative hypothesis:} \quad & E(\text{MUF}_1/H_1) = M_1 \end{aligned} \tag{2.4}$$

Let s_1 be the significance threshold of the test. Then the statement of the inspector will be as follows:

$$\begin{aligned} \text{MUF}_1 \leq s_1 & : H_0 \text{ is correct} \\ \text{MUF}_1 > s_1 & : H_1 \text{ is correct} \end{aligned}$$

Here, two kinds of false statements are possible:

- (i) The inspector states 'H₁ is correct' where in fact H₀ is correct (false alarm; error of the first kind)
- (ii) The inspector states 'H₀ is correct' where in fact H₁ is correct (error of the second kind).

The probabilities for committing these errors are called α_1 and β_1 :

$$\begin{aligned} \alpha_1 & := \text{prob} \{ \text{MUF}_1 > s_1/H_0 \} \\ \beta_1 & := \text{prob} \{ \text{MUF}_1 \leq s_1/H_1 \} \end{aligned} \tag{2.5}$$

$1-\beta_1$ is called probability of detection.

In case the random variables I_0 , D_1 and I_1 are normal distributed one has

$$1-\alpha_1 = \Phi\left(\frac{s_1}{\sigma_1}\right) \tag{2.6a}$$

$$\beta_1 = \Phi\left(\frac{s_1 - M_1}{\sigma_1}\right) \tag{2.6b}$$

Here, Φ is the normal distribution function:

$$\Phi(x) = \frac{1}{\sqrt{2\pi}} \int_{-\infty}^x \exp\left(-\frac{t^2}{2}\right) dt$$

In eq. (2.6 b) the significance threshold s_1 can be eliminated with the help of (2.6a); one obtains

$$1-\beta_1 = \Phi\left(\frac{M_1}{\sigma_1} - U_{1-\alpha_1}\right) \quad (2.7)$$

where U is the inverse function of the normal distribution function.

2.2 Two inventory periods

2.2.1 Formulation of the problem

It is common opinion now that in the case of large nuclear plants no more than two physical inventories shall be taken per year because of the effort connected with this procedure. As furthermore, the reference interval of time should be one year, one has to consider now the problem of a sequence of two inventories and the decision theoretical problems connected therewith.

Two problems arise from the side of the inspector:

- (i) In which way should the starting inventory for the second inventory period be chosen if the physical inventory at the end of the first inventory period is not exactly known?
- (ii) In which way should the two significance thresholds for the two MUF-values be chosen if a boundary in form of a fixed false alarm rate for the two inventory periods, i.e. for the reference interval of time is given?

Additionally, there arises a third problem which also can be called the problem of the operator who wants to divert material: If it is assumed that the amount M of material shall be diverted in the reference interval of time, what is the optimal distribution of diversion on the two inventory periods ($M_1, M_2: M_1+M_2 = M$)? The inspector has to determine this optimal distribution, too, in order not to overestimate his probability of detection.

2.2.2 Starting inventory for the second inventory period

it is assumed that at the end of the first inventory period the MUF was not significant. Then the inspector can use either the ending book or physical inventory as the starting inventory for the second inventory period.

According to a proposal of Stewart /3/ a linear combination of these two inventories will be chosen, more exactly, a minimum variance unbiased estimate S:

$$S = a \cdot B_1 + (1-a) \cdot I_1, \quad 0 \leq a \leq 1$$

$$\text{var } S = \text{Minimum} \quad (2.8)$$

The calculation gives

$$a = \frac{\sigma_{I1}^2}{\sigma_{I0}^2 + \sigma_{D1}^2 + \sigma_{I1}^2} \quad (2.9)$$

The variance of S, σ_S^2 is given by the relation

$$\frac{1}{\sigma_S^2} = \frac{1}{\sigma_{I0}^2 + \sigma_{D1}^2} + \frac{1}{\sigma_{I1}^2} \quad (2.10)$$

From this relation one can take that the variance of this estimate S is smaller than the variance of both the book and the physical inventory.

This choice of the estimate of the starting inventory has further consequences. In order to explain these the two material balances to be closed during the reference interval of time $(t_0, t_2) = (t_0, t_1) + (t_1, t_2)$ are listed:

$$MUF_1 = I_0 + D_1 - I_1 \quad (2.11)$$

$$MUF_2 = S + D_2 - I_2$$

Under the alternative hypothesis H_1 , i.e. under the assumption that the operator diverts in the first inventory period the amount M_1 , in the second the amount M_2 , the probability $1-\beta$ to detect at least one diversion is given by the relation

$$\beta = \text{prob} \{MUF_1 \leq s_1 \wedge MUF_2 \leq s_2\} \text{ for } H_1 \quad (2.12a)$$

From this relation one obtains the overall false alarm probability α , i.e. the probability of detection under the null hypothesis H_0 (no diversion)

$$1-\alpha = \text{prob} \{MUF_1 \leq s_1 \wedge MUF_2 \leq s_2\} \text{ for } H_0 \quad (2.12b)$$

Now the problem arises that the two random variables MUF_1 and MUF_2 are in general not independent as in the starting inventory components of the first random variables occur. However, if one chooses the starting inventory in the way described above, one has

$$\text{cov}(MUF_1, MUF_2) = 0 \quad (2.13)$$

If one assumes furthermore that all components are normal distributed one obtains the result that the random variables MUF_1 and MUF_2 are independent. This means that one obtains from (2.12) and (2.13) the relations

$$1-\alpha = \text{prob} \{MUF_1 \leq s_1\} \cdot \text{prob} \{MUF_2 \leq s_2\} \text{ for } H_0 \quad (2.14a)$$

$$\beta = \text{prob} \{MUF_1 \leq s_1\} \cdot \text{prob} \{MUF_2 \leq s_2\} \text{ for } H_1 \quad (2.14b)$$

As one has according to (2.5)

$$\text{prob} \{MUF_i \leq s_i / H_0\} = 1-\alpha_i, \quad i = 1, 2$$

one obtains from eq. (2.14a)

$$1-\alpha = (1-\alpha_1)(1-\alpha_2) \quad (2.15)$$

In order to be able to calculate these probabilities one has to determine the expectation values and variances of MUF_1 and MUF_2 under the null and the alternative hypothesis.

In case of the null hypothesis (no diversion) one has according to eqs. (2.3), (2.11) and (2.10)

$$E(MUF_1) = 0; \text{var}(MUF_1) = \sigma_1^2$$

$$H_0: E(MUF_2) = 0; \text{var}(MUF_2) = \sigma_s^2 + \sigma_{D2}^2 + \sigma_{I2}^2 = \sigma_2^2 \quad (2.16)$$

In case of the alternative hypothesis the variances $\text{var}(MUF_1)$ and $\text{var}(MUF_2)$ are the same as before. The expectation value of MUF_1 is given by

$$H_1: E(MUF_1) = M_1 \quad (2.17a)$$

The expectation value of MUF_2 is not only M_2 as a part of M_1 occurs in the second inventory period because of the choice of the starting inventory.

The result of the calculation which shall not be given here is

$$H_1: E(MUF_2) = a \cdot M_1 + M_2 \quad (2.17b)$$

Here, a is given by eq. 2.9.

As has been assumed already earlier all random components are assumed to be normal distributed therefore, MUF_1 and MUF_2 are normal distributed with expectation values and variances given by eqs. (2.16) and (2.17), and the overall probability of detection in the case of the diversion of the amount $M = M_1 + M_2$ of material can be calculated with the help of eq. (2.14b). The result is

$$\beta = \Phi\left(U_{1-\alpha_1} - \frac{M_1}{\sigma_1}\right) \cdot \Phi\left(U_{1-\alpha_2} - \frac{a \cdot M_1 + M_2}{\sigma_2}\right) \quad (2.18)$$

2.2.3 Decision theoretical analysis

As has been mentioned already in section 2.2.1 the problem arises now to 'distribute' α_1 and α_2 in such a way that an overall false alarm probability α according to relation 2.15 is guaranteed. Furthermore, the inspector wants to determine the guaranteed probability of detection with respect to the total diversion $M = M_1 + M_2$. This means that he has to consider that distribution (M_1, M_2) which minimizes the probability of detection. As a result, one has to calculate

$$\beta_{\text{guar}} := \min_{\alpha_1, \alpha_2} \max_{M_1, M_2} \left(\phi \left(U_{1-\alpha_1} - \frac{M_1}{\sigma_1} \right) \cdot \phi \left(U_{1-\alpha_2} - \frac{a \cdot M_1 + M_2}{\sigma_2} \right) \right) \quad (2.19a)$$

where

$$(1-\alpha_1)(1-\alpha_2) = 1-\alpha; \quad M_1+M_2 = M \quad (2.20)$$

On the other hand, the operator who has the intention to divert material will try this in an optimal way; he will choose M_1, M_2 such that he obtains a maximal guaranteed β :

$$\beta'_{\text{guar}} := \max_{M_1, M_2} \min_{\alpha_1, \alpha_2} \left(\phi \left(U_{1-\alpha_1} - \frac{M_1}{\sigma_1} \right) \phi \left(U_{1-\alpha_2} - \frac{aM_1 + M_2}{\sigma_2} \right) \right) \quad (2.19b)$$

Here again the boundary conditions (2.20) have to be observed. The behaviour of the two 'players' corresponds to the behaviour of two players in a so-called zero-sum game (where the gain of one player is the loss of the other and inversely). A justification for the fact that the probability of the error of the second kind is chosen as the payoff is given in Ref. /2/.

Both players cannot do anything better than choosing their strategies in such a way that $\beta_{\text{guar}} = \beta'_{\text{guar}}$, i.e. they have to look for a saddle point.

Without going into the rather complicated analysis with respect to the existence of saddlepoints /4/, the results which are interesting in this connection shall be reported here.

As can be seen from the constraints (2.20) one can replace the function defined in (2.18) by

$$\beta(\alpha_1, M_1) := \phi \left(U(1-\alpha_1) - \frac{M_1}{\sigma_1} \right) \cdot \phi \left(U \left(\frac{1-\alpha}{1-\alpha_1} \right) - \frac{M-(1-a)M_1}{\sigma_2} \right) \quad (2.18a)$$

$$0 \leq \alpha_1 \leq \alpha, \quad 0 \leq M_1 \leq M.$$

The results concerning the existence and characterisation of a saddlepoint of the function $\beta(\alpha_1, M_1)$ are listed below.

Let α be arbitrary $0 < \alpha < 1$.

1. It exists a uniquely determined saddlepoint of $\beta(\alpha_1, M_1)$ for every $M > 0$.
2. Let $(\bar{\alpha}_1, \bar{M}_1)$ be the saddlepoint of $\beta(\alpha_1, M_1)$. Then $\bar{M}_1 > 0$, $0 < \bar{\alpha}_1 < \alpha$
3. The point $(\bar{\alpha}_1, M)$ is the saddlepoint of $\beta(\alpha_1, M_1)$ if

$$\left. \frac{\partial}{\partial M_1} \beta(\bar{\alpha}_1, M_1) \right|_{M_1=M} \geq 0$$

$$\text{and } \beta(\bar{\alpha}_1, M) = \min_{0 \leq \alpha_1 \leq \alpha} \beta(\alpha_1, M)$$

holds.

4. The point $(\bar{\alpha}_1, \bar{M}_1)$ is the saddlepoint of $\beta(\alpha_1, M_1)$ if $\bar{\alpha}_1$ solves

$$\frac{1-\alpha}{(1-\alpha_1)^2} e^{\frac{1}{2} U^2 \left(\frac{1-\alpha}{1-\alpha_1} \right)} - \frac{1-a}{\sigma_2} \sigma_1 e^{\frac{1}{2} U^2 (1-\alpha_1)} = 0$$

$$\text{and } \beta(\bar{\alpha}_1, \bar{M}_1) = \max_{0 \leq M_1 \leq M} \beta(\bar{\alpha}_1, M_1)$$

holds.

5. No other types of saddlepoints than those characterized by (3.) and (4.) exist.
6. If $\frac{1}{\sigma_1} \geq \max \left(\frac{1-a}{\sigma_2}, \frac{a}{\sigma_2} \right)$, then the saddlepoint is of type (4.) for all M .

This fact is important because $\bar{\alpha}_1$ (i.e. the optimal inspector strategy) is in this case independent of M (the total amount assumed to be diverted). This can be seen immediately from (4.), because the equation for the determination of $\bar{\alpha}_1$ does not involve M_1 and M .

The inequality $\frac{1}{\sigma_1} \geq \max \left(\frac{1-a}{\sigma_2}, \frac{a}{\sigma_2} \right)$ holds e.g. in the case

$$\sigma_{I0} = \sigma_{I1} = \sigma_{I2}; \sigma_{D1} = \sigma_{D2}$$

2.2.4 Treatment of systematic errors which cannot be described by variances

In the case that the systematic errors are not of random origin or are fixed throughout the reference time (and can not be described by variances therefore) equation (2.18) for the probability of non-detection must be modified.

Let us assume that the measurements I_0, I_1, I_2, D_1, D_2 are composed in the following way:

$$I_0 = \underline{I}_0 + e_0 + s_0$$

$$I_1 = \underline{I}_1 + e_1 + s_1$$

$$I_2 = \underline{I}_2 + e_2 + s_2$$

$$D_1 = \underline{D}_1 + e_3 + s_3$$

$$D_2 = \underline{D}_2 + e_4 + s_4$$

Here the $\underline{I}_i, \underline{D}_i$ are the true values, e_i the random measurement errors (with expectation-value zero) and the s_i are the unknown but fixed values of the systematic errors.

We further assume that the s_i are confined to finite intervalls J_i , i.e. $s_i \in J_i, l_i < \infty$ where l_i is the length of J_i .

Then the probability of non-detection β is bounded by

$$\beta \leq \Phi(U(1-\alpha_1)+T_1 - \frac{M_1}{\sigma_1}) \cdot \Phi(U(1-\alpha_2)+T_2 - \frac{aM_1+M_2}{\sigma_2}) \quad (2.21)$$

where $T = \frac{1}{\sigma_1} (l_0 + l_1 + l_3)$, $T = \frac{1}{\sigma_2} (a(l_0 + l_3) + (1-a)l_1 + l_2 + l_4)$

with the constraints $1-\alpha = (1-\alpha_1)(1-\alpha_2)$, $M = M_1 + M_2$

As for an unfavourable choice of s_i , $i = 0, \dots, 4$ equality in (2.21) can hold, one has to calculate:

$$\beta_{\text{guar}} = \min_{\alpha_1, \alpha_2} \max_{M_1, M_2} \Phi(U(1-\alpha_1)+T_1 - \frac{M_1}{\sigma_1}) \cdot \Phi(U(1-\alpha_2)+T_2 - \frac{aM_1+M_2}{\sigma_2}) \quad (2.22)$$

By use of the constraints the right side of (2.21) can be expressed by

$$\beta_s(\alpha_1, M_1) := \phi(U(1-\alpha_1) + T_1 - \frac{M_1}{\sigma_1}) \cdot \phi(U(\frac{1-\alpha}{1-\alpha_1})) + T_2 - \frac{M-(1-a)M_1}{\sigma_2} \quad (2.23)$$

$$0 \leq \alpha_1 \leq \alpha, \quad 0 \leq M_1 \leq M;$$

$$0 < \alpha < 1$$

$$0 < M.$$

One can show that $(\bar{\alpha}_1, \bar{M}_1)$ is a saddlepoint if and only if one of the following three conditions does hold

$$a) \quad \bar{M}_1 = M \quad \text{and} \quad \beta_s(\bar{\alpha}_1, M) = \min_{0 \leq \alpha_1 \leq \alpha} \beta_s(\alpha_1, M)$$

$$b) \quad \bar{M}_1 = 0 \quad \text{and} \quad \beta_s(\bar{\alpha}_1, 0) = \min_{0 \leq \alpha_1 \leq \alpha} \beta_s(\alpha_1, 0)$$

$$c) \quad \beta_s(\bar{\alpha}_1, \bar{M}_1) = \max_{0 \leq M_1 \leq M} \beta_s(\bar{\alpha}_1, M_1)$$

and $\bar{\alpha}_1$ solves

$$\frac{1-\alpha}{(1-\alpha_1)^2} e^{\frac{1}{2} U^2(\frac{1-\alpha}{1-\alpha_1})} - \frac{1-a}{\sigma_2} \sigma_1 e^{\frac{1}{2} U^2(1-\alpha_1)} = 0.$$

3. Verification of data

3.1 D-statistics for one class of material

In the following a set of N data is considered which has been reported in the course of a campaign, and it is assumed that it is possible to verify these data by means of independent measurements at the end of the campaign.

Let x_j , $j = 1 \dots N$, be the measurement result for the material content of the j -th batch reported by the operator. Let furthermore y_j , $j = 1 \dots n$, be the result of the independent measurement of the inspector. It is assumed that the measurement errors are normal distributed with expectation value zero; the variances of the random (r) and systematic (s) errors of the operator's (O) and inspector's (I) measurements are σ_{Or}^2 , σ_{Os}^2 , σ_{Ir}^2 , σ_{Is}^2 .

In order to make a statement whether the data of the operator are correct or not the inspector forms the so-called D-statistics

$$D = \frac{N}{n} \sum_{j=1}^n (y_j - x_j) \quad (3.1)$$

that means he verifies only those data reported by the operator which he has measured himself - the reason for this is that by means of this procedure the influence of the variation of the true material contents of the batches is eliminated.

Under the null hypothesis H_0 , i.e. under the assumption that no data reported by the operator are falsified the expectation value and the variance of D are given by the following expressions (with $\sigma_r^2 = \sigma_{Or}^2 + \sigma_{Ir}^2$, $\sigma_s^2 = \sigma_{Os}^2 + \sigma_{Is}^2$):

$$E(D/H_0) = 0 \quad \text{var}(D/H_0) = : \sigma_{D/H_0}^2 = N^2 \left(\frac{\sigma_r^2}{n} + \sigma_s^2 \right) \quad (3.2)$$

Under the alternative hypothesis H_1 , i.e. under the assumption that r of the N batches are falsified by the amount μ , one obtains

$$E(D/H_1) = \mu \cdot r = : M$$

$$\text{var}(D/H_1) = : \sigma_{D/H_1}^2 = N^2 \left(\frac{\sigma_r^2}{n} + \sigma_s^2 + \mu^2 \cdot \frac{r}{N} \cdot \frac{N-r}{N} \left(\frac{1}{n} - \frac{1}{N} \cdot \frac{n-1}{N-1} \right) \right) \quad (3.3)$$

In Fig. 1.1 some examples for the standard deviation σ_{D/H_1} are given. It is to be seen in which way the standard deviation is increased compared to the standard deviation in the case of no data falsification if the sample size becomes small.

With the help of the D-statistics the inspector decides whether he takes the null hypothesis to be true or not: If D is greater than a given significance threshold he decides that the alternative hypothesis is true (more exactly that anything is wrong). The significance threshold is fixed by the choice of the probability of the error of the first kind.

$$\alpha : = \text{prob} \{ D > s/H_0 \} \quad (3.4)$$

As in the foregoing chapter the test is characterized by the probability of detection (one minus the error of the second kind β):

$$\beta : = \text{prob} \{ D \leq s/H_1 \} \quad (3.5)$$

If one eliminates in this formula the significance threshold with the help of α , one obtains from (3.1), see Ref. /5/

$$\beta = \sum_{k=\max(0, n+r-N)}^{\min(n, r)} \Phi \left(U_{1-\alpha} - \frac{k}{\sqrt{n}} \cdot \frac{\mu}{\sigma} \right) \frac{\binom{r}{k} \binom{N-r}{n-k}}{\binom{N}{n}} \quad (3.6a)$$

Here, σ is given by

$$\sigma^2 = n \cdot (\sigma_{Or}^2 + \sigma_{Ir}^2) + n^2 \cdot (\sigma_{Os}^2 + \sigma_{Is}^2) \quad (3.6b)$$

This formula can be used, e.g. for the determination of the sample size n in case all the other parameters including α and β are given.

A computer program for it is given in Tables 1a and 1b.

As formula (3.6) represents a very complicated formula it is interesting to have a simple approximate formula. If one assumes the random variable D to be normal distributed with the expectation values and variances given by eqs. (3.2) and (3.3) one has instead of eq. (3.6)

$$\beta = \Phi\left(\frac{U_{1-\alpha} \cdot \sigma_{D/H_0}^{-\mu \cdot r}}{\sigma_{D/H_1}}\right) \quad (3.7)$$

The quality of the approximation can be taken from Figs. 1.2, 1.3 and 1.4. In these figures the exact and the approximate distribution functions are represented graphically. As can be taken from the figures the approximation is the better, the higher n and r are; however, the influence of n is stronger than that of r : see, e.g. the cases $(n, r) = (49, 5)$ and $(n, r) = (5, 49)$ respectively.

The question arises what value of μ the operator will choose. This value cannot be arbitrarily large, e.g. because there exists a batch-to-batch-variation which is known to the inspector (which means that the amount falsified cannot be larger than the batch-to-batch-variation). If the operator wants to divert the amount $M = \mu \cdot r$, it follows from eq. (3.3) that the variance takes its maximum if r is as small and μ is as large as possible thus, this is the best choice in the framework of the approximation (3.7). However, this must not be so if one works with the exact formula as can be seen from Fig. 1.5. Generally, one can say that it is best from the point of view of the operator that

- (i) r should be as small as possible if M is large compared to the standard deviation of the sum of the measurement errors of all N batches
- (ii) r should be as large as possible if M is small compared to the standard deviation of the sum of the measurement errors of all N batches.

Instead of adding all data of one class and comparing the sums of the operator's reported data and the inspectors own findings, the inspector can also check the reported data by comparing the single data of each batch. This method however, has the disadvantage that it is not possible to give an analytical expression which takes into account the effect of systematic errors. If one neglects systematic errors one obtains for the probability of an error of the second kind instead of formula (3.6) the following expression

$$\beta = \sum_{k=\max(0, n+r-N)}^{\min(n, r)} \left(\Phi \left(U \frac{r-k}{\sqrt{1-\alpha}} - \frac{\mu}{\sigma} \right) \right)^k (1-\alpha)^{1-\frac{k}{n}} \frac{\binom{r}{k} \binom{N-r}{n-k}}{\binom{N}{n}} \quad (3.8)$$

Here, σ is given by

$$\sigma^2 = \sigma_{Ir}^2 + \sigma_{Or}^2$$

It is possible to give examples for the case that this statistical procedure is better than the D-statistics. As however, in many cases the D-statistics is more effective and as furthermore, in the case of the D-statistics the effect of systematic errors can be taken into account in a very natural way, only the latter procedure will be used in the following.

3.2 D-statistics for several classes of material

In case of R different classes of material with different parameters N_i, μ_i, σ_i^2 the operator forms according to eq. (3.1) the following expression

$$D = \sum_{i=1}^R \frac{N_i}{n_i} \sum_{j=1}^{n_i} (y_{ij} - x_{ij}) \quad (3.9)$$

The expectation values and variances of the random variable D under the null hypothesis H_0 and the alternative hypothesis are given by

$$E(D/H_0) = 0$$

$$\text{var}(D/H_0) = \sigma_{D/H_0}^2 = \sum_{i=1}^R N_i^2 \left(\frac{\sigma_{ri}^2}{n_i} + \sigma_{si}^2 \right) \quad (3.10)$$

$$E(D/H_1) = \sum_i \mu_i \cdot r_i = :M$$

$$\text{var}(D/H_1) = \sigma_{D/H_1}^2 = \sum_{i=1}^R N_i^2 \left(\frac{\sigma_{ri}^2}{n_i} + \sigma_{si}^2 + \mu_i^2 \cdot \frac{r_i}{N_i} \frac{N_i - r_i}{N_i} \left(\frac{1}{n_i} - \frac{1}{n_i} \cdot \frac{n_i - 1}{N_i - 1} \right) \right)$$

The distribution function of the random variable D cannot be given in a closed analytical form. An approximation on the basis of the assumption that D is normal distributed is used in the following; with this approximation one obtains a form for the error of the second kind which corresponds exactly to eq. (3.7).

Two problems now arise

- (i) What is the necessary effort for the verification of the data of the R classes of material?
- (ii) What is the optimal distribution of a given effort on the R different classes.

As has been mentioned already in the introduction it is necessary for the answer of these questions to perform a game theoretical analysis with the probability of detection as the payoff to the inspector. The set of strategies of the inspector is the set of possibilities to choose the sample sizes $n_i, i = 1, \dots, R$, such that the boundary condition

$$C \geq \sum_i \epsilon_i n_i \tag{3-11}$$

is met where C is the inspection effort available and ϵ_i the effort to verify a datum of the i-th class.

The set of strategies of the operator is the set of possibilities to choose the sample sizes $r_i, i = 1, \dots, R$, such that

$$M \leq \sum_i \mu_i r_i \tag{3-11'}$$

It follows from the fact that the distribution function of D cannot be determined analytically that there does not exist an analytical solution of the problem.

⁺) When in the following by applying the Lagrange multipliers technique n_i and r_i are treated as continuous variables, then instead of (3-11), (3-11') the boundary conditions $C = \sum_i \epsilon_i n_i$, $M = \sum_i \mu_i r_i$ are used.

In Ref /5/, an exact solution has been given for the special case that both players - operator and inspector - decide independently and without knowing from each other to choose only one class for their activities. The optimal strategies were mixed strategies where the respective classes are chosen at random according to a well defined random distribution. Although this case is very interesting from a theoretical point of view, especially with respect to the problem of the propagation and choice of false alarm probability, it will not be considered here.

If one takes the normal approximation to be valid and if one furthermore assumes that M is large compared to $U_{1-\alpha} \cdot \sigma_{D/H_0}$ one can take the variance σ_{D/H_1}^2 eq. (3-10) as the payoff to the operator as the probability of detection is a monotone function of that quantity. In fact, it was the proposal of Stewart /6/ to take that quantity as the criterion of optimization for the inspector's strategy.

Stewart took the variance (3-10) in the formula
(n, N >> 1, no systematic errors)

$$\text{var}(D/H_1) = \sum_i N_i \left(\frac{\sigma_{ri}^2}{n_i} + \mu_i^2 \frac{r_i}{N_i} \cdot \frac{N_i - r_i}{N_i} \left(\frac{1}{n_i} - \frac{1}{N_i} \right) \right) \quad (3-12)$$

and minimized it with respect to the n_i under the boundary condition (3-11). The result, obtained with the help of the method of Lagrange multipliers, was

$$n_i = \frac{C}{\sum_j \sqrt{\epsilon_j} S_j} \cdot \frac{S_i}{\sqrt{\epsilon_i}} ; S_i^2 = N_i^2 \left(\sigma_{ri}^2 + \mu_i^2 \cdot \frac{r_i}{N_i} \cdot \frac{N_i - r_i}{N_i} \right)$$

$$\min_{n_i} \text{var} (D/H_1) = \frac{1}{C} \left(\sum_i \sqrt{\epsilon_i} S_i \right)^2 - \sum_i \mu_i^2 \frac{r_i}{N_i} \cdot \frac{N_i - r_i}{N_i} \quad (3-13)$$

With respect to the r_i he did not perform an optimization; he gave an estimate of the 'relative frequencies of diversion $\left(\frac{r_1}{N_1} \dots \frac{r_R}{N_R} \right)$ '. An example is shown in Fig. 1.6 and 1.7 where two

classes of Stewart's example have been taken, and where the optimization with respect to both variables has been performed.

The numerical example is

	N_i	σ_{ri}	μ_i	ϵ_i
1	200	0.327	1.44	28
2	60	0.382	1.50	30

As one can take from the figures the optimal choice of the number of batches to be falsified is far from Stewart's estimate however, the maximum of the standard deviation and the minimum of the probability of detection does not differ very much from Stewart's estimate.

As it is not possible to perform the maximization of the variance (3-13) with respect to the r_i , $i = 1..R$, one either has to do it numerically or to make further approximations.

In reference /5/ the following assumptions have been made

- (i) $1 \ll n_i, r_i \ll N_i$, $i = 1, \dots, R$
- (ii) $\sigma_{r_i}^2 / n_i \ll \sigma_{s_i}^2$, $i = 1, \dots, R$

After neglecting some terms according to the assumptions above the variance is approximated by

$$\text{var}(D/H_1) = \sum_{i=1}^R (N_i^2 \sigma_{s_i}^2 + N_i \mu_i^2 \frac{r_i}{n_i}) \quad (3-14)$$

Treating n_i and r_i as continuous variables the saddlepoint coordinates of the expression (3-14) can be calculated by the method of the Lagrange multipliers:

$$n_i^o = C \cdot N_i \cdot \mu_i / \sum_j N_j \epsilon_j \mu_j \quad (3-14a)$$

$$r_i^o = M \cdot N_i \cdot \epsilon_i / \sum_j N_j \epsilon_j \mu_j \quad (3-14b)$$

Inserting these values in (3-14) yields

$$\min_{n_i} \max_{r_i} \text{var} (D/H_1) = \sum_{i=1}^R (N_i^2 \sigma_{si}^2 + \frac{M}{C} N_i \epsilon_i \mu_i) \quad (3-14c)$$

In Fig. 1.8 the optima of the standard deviation and the optimal guaranteed probability of detection are calculated for the example used for Fig. 1.6 and 1.7. The dashed curve is calculated with the help of the approximation (3-14) which has been used in the form ($\sigma_{si}^2 = 0$)

$$\begin{aligned} \sigma_{D/H_1}^2 &= \sum_i \left(\frac{N_i^2 \sigma_{ri}^2}{n_i^o} + \frac{M}{C} \cdot N_i \epsilon_i \mu_i \right) = \\ &= \frac{1}{C} \sum_i N_i \epsilon_i \mu_i \left(\sum_i \frac{N_i \sigma_{ri}^2}{\mu_i} + M \right) \end{aligned}$$

As can be taken from the figure, the approximation works quite well if $1 < n_i < N_i$ which had to be assumed for the derivation of (3-14).

In order to have things not too complicated the approximate decision theoretical solution will always be used, even in cases where the assumptions do not hold very well. As a justification for this the fact will be taken that even if one may be not too near to the optimal strategy the optimal probability of detection may be not too far from the solution gained by the approximation.

In this way the question of the optimal allocation of effort shall be answered. The question of the necessary total effort shall be answered in the same way as in the case of only one class of material:

If all parameters including M , α and β for the optimal case are fixed one can determine the necessary effort C according to the relation

$$C = \sum_i N_i \epsilon_i \mu_i \left[\frac{1}{M} \sum_i \frac{N_i \sigma_{ri}^2}{\mu_i} (U_{1-\beta} + U_{1-\alpha}) + U_{1-\beta} \right] \quad (3-14d)$$

A further approach is given in the following.

We take the variance in the form (3-12) + systematic error, i.e.

$$\text{var } (D/H_1) = \sum_i N_i^2 \left(\sigma_{si}^2 + \frac{\sigma_{ri}^2}{n_i} + \mu_i^2 \frac{r_i}{N_i} \cdot \frac{N_i - r_i}{N_i} \left(\frac{1}{n_i} - \frac{1}{N_i} \right) \right) \quad (3-15)$$

$$\text{Now we define } r_i^o = \frac{N_i}{2}, \quad \mu_i^o = \frac{2M\mu_i}{\sum_i \mu_i N_i} \quad (3-15a)$$

$$\text{Obviously } r_i^o \text{ and } \mu_i^o \text{ fulfill } M = \sum_i \mu_i^o r_i^o$$

With the method of the Lagrange multipliers, neglecting σ_{ri}^2/n_i , one obtains the optimal n_i by

$$n_i^o = \frac{C \cdot \sqrt{a_i}}{\sqrt{\epsilon_i} \sum_j \sqrt{\epsilon_j} a_j} \quad \text{with } a_i = \frac{1}{4} \mu_i^o{}^2 \cdot N_i^2 \quad (3-15c)$$

setting $\mu_i = \sigma_{si}$ and μ_i^o as defined above, one gets

$$n_i^o = \frac{\sigma_{si} \cdot N_i \cdot C}{\sqrt{\epsilon_i} \sum_j \sigma_{sj} N_j \sqrt{\epsilon_j}}$$

In the case that $M \geq \frac{1}{2} \cdot \sum_i \mu_i N_i$ holds it can easily be shown that

the value (3-15c) is an upper bound for the expression $\min_{n_i} \max_{r_i} \text{var } (D/H_1)$,
 $\text{var } (D/H_1)$ given

$$\text{by (3-15), } M = \sum_i \mu_i r_i, \quad C = \sum_i \epsilon_i n_i.$$

That means that when taking the variance in the form (3-15c) one always lies on the safe side when $M \geq \frac{1}{2} \cdot \sum_i \mu_i N_i$ holds.

In the figure 1.9 the standard deviation and the optimal guaranteed probability of detection are calculated with the data of Stewart's numerical example (taking $\sigma_{si} = 0$).

A disadvantage of all these methods presented above is the fact that when using the method of the Lagrange multipliers the obvious constraints $n_i \leq N_i$, $r_i \leq N_i$ were never taken into account. (The theorems which are available for the Lagrange multipliers method with inequality constraints

yielded no analytical solutions for the problems regarded here).

Therefore it may happen that $n_i^0 > N_i$ or $r_i^0 > N_i$ holds. In these cases the correct but somewhat arduous procedure would be to use the discrete dynamic optimization techniques.

Another proposal for the approach (3-15) - (3-15c) is sketched here:

Let the n_i^0 be divided into subsets $n_{i_u}^0$, $n_{i_v}^0$, $u = 1, \dots, U$,

$v = 1, \dots, V$, where $n_{i_u}^0 \geq N_{i_u}$, $n_{i_v}^0 < N_{i_v}$ holds.

Then define $n_{i_u}^0 = N_{i_u}$, $C' = C - \sum_{u=1}^U \epsilon_{i_u} \cdot N_{i_u}$

and $M' = M - \frac{1}{2} \sum_{u=1}^U \mu_{i_u} \cdot N_{i_u}$

The new $n_{i_v}^0$ are then calculated by minimizing the expression

$$\sum_{v=1}^V N_{i_v}^2 \left(\sigma_{s_{i_v}}^2 + \frac{\sigma_{r_{i_v}}^2}{n_{i_v}^2} + \mu_{i_v}^2 \frac{r_{i_v}}{N_{i_v}} \cdot \frac{N_{i_v} - r_{i_v}}{N_{i_v}} \right) \cdot \left(\frac{1}{n_{i_v}^0} - \frac{1}{N_{i_v}} \right)$$

under the constraints $C' = \sum_{v=1}^V \epsilon_{i_v} n_{i_v}^0$, $M' = \sum_{v=1}^V \mu_{i_v} r_{i_v}$

according to the method described in (3-15) - (3-15c).

This procedure can be repeated till all the so calculated n_i^0 fulfill the constraints $n_i^0 \leq N_i$, $i=1, \dots, R$.

It must be mentioned however, that these n_i^0 must not necessarily yield $\min \text{var} (D/H_1)$ but may give a too pessimistic, i.e. a too large value for the variance.

3.3 Modified D-statistics

In the foregoing treatment it had been assumed that in case of a falsification of data from one or more classes of material the inspector can find in his sample batches the data of which are falsified. There are however, cases where

the inspector never can find falsified batches by means of this sampling technique.

An example for this case is a sequence of input batches in a reprocessing plant. The concentration analyses can be verified at the end of a campaign if the samples can be stored. Therefore, the inspector has the chance to detect falsified analyses even if he verifies only a part of the data. The volume data however, can only be verified as long as the batches are available. In these cases it is clear that the operator - if at all - will falsify only data of those batches which are not verified by the inspector. Falsification of this kind can be detected by the inspector if he compares the sum of his own data with the sum of all operator data /5/.

In the case of one class of batches the inspector has to form the quantity

$$D = \frac{N}{n} \sum_{j=1}^n y_j - \sum_{n=1}^N x_j \quad (3.16)$$

(instead of (3.1)). This means he has to use all reported data of the operator, contrary to the case discussed before.

The expectation values of this new D-statistics in case of no diversion (null hypothesis H_0) and in case of the diversion M (alternative hypothesis H_1) and the variances are given by

$$E(D/H_0) = 0 \quad E(D/H_1) = M$$

$$\text{var}(D/H_0) = \text{var}(D/H_1) = : \sigma^2 \quad (3.17)$$

$$\sigma^2 = N^2 \left[\frac{1}{N} \sigma_{0r}^2 + \frac{1}{n} \sigma_{1r}^2 + \sigma_{0s}^2 + \sigma_{1s}^2 + \left(\frac{1}{n} - \frac{1}{N} \right) \sigma_v^2 \right]$$

Here, σ_v^2 is the batch-to-batch variation, i.e.

$$\sigma_v^2 = \frac{1}{N-1} \sum_{i=1}^N (W_i - \bar{W})^2 ; \quad \bar{W} = \frac{1}{N} \sum_{i=1}^N W_i \quad (3.18)$$

where W_i is the true material content of the i-th batch.

If one assumes that also the true values are normal distributed one can construct a significance test; the probability of detection is given as usually by the expression

$$1-\beta = \Phi\left(\frac{M}{\sigma} - U_{1-\alpha}\right) \quad (3.19)$$

In the case of R different classes of batches there arise problems because it is not always correct to form the difference D between the sums of the inspector and operator data.

If one considers the classes of input and output measurements, the operator will in case of a falsification report too small values for the first, too large values for the second class, thus the sum of the differences may cancel partially or completely. In this case the inspector should form the difference of the differences. However, there are also cases possible where this procedure does not work.

As a consequence the only meaningful procedure seems to be the establishment and test of all possible sums and differences of class-differences.

According to former considerations again the problem arises to minimize the variance

$$\text{var}(D/H_1) = \sum_{i=1}^R N_i (\sigma_{Ori}^2 + \sigma_{vi}^2) + N_i^2 (\sigma_{Osi}^2 + \sigma_{Isi}^2) + \frac{N_i^2}{n_i} (\sigma_{Iri}^2 + \sigma_{vi}^2) \quad (3.20)$$

with respect to the cost boundary condition

$$\sum_{i=1}^R \epsilon_i \cdot n_i \leq C \quad (3.21)$$

If one considers the variables n_i approximately to be continuous variables one can treat this problem with the help of Lagrange multipliers. Then the optimal sample sizes n_i^0 , $i = 1 \dots k$, are given by

$$n_i^0 = \frac{C}{\sum_j N_j \sqrt{\epsilon_j (\sigma_{vj}^2 + \sigma_{Iri}^2)}} \cdot N_i \cdot \frac{\sqrt{\sigma_{vi}^2 + \sigma_{Iri}^2}}{\epsilon_i}, \quad i = 1 \dots R \quad (3.22)$$

4. Conclusion

Three possible modes of diversion in connection with the material balance verification have been considered in the foregoing chapters:

- (i) Diversion by simply taking off material and hoping that the unaccuracy of the material balance covers this diversion (chapter 2)
- (ii) Diversion by falsification of data which are verified by means of the D_1 -statistics (chapter 3.1,2)
- (iii) Diversion by falsification of data which are verified by means of the D_2 -statistics (chapter 3.3)

The overall probability of detection $1-\beta$ per year in case of two inventory periods per year and in case of the total amount M to be diverted per year (alternative hypothesis H_1) is given by the relation

$$\beta = \text{prob} \{MUF_1 \leq s_1 \wedge MUF_2 \leq s_2 \wedge D_1 \leq s_3 \wedge D_2 \leq s_4 / H_1\} \quad (4.1)$$

Accordingly the overall false alarm probability α per year in case of no diversion (null hypothesis H_0) is given by the relation

$$1-\alpha = \text{prob} \{MUF_1 \leq s_1 \wedge MUF_2 \leq s_2 \wedge D_1 \leq s_3 \wedge D_2 \leq s_4 / H_0\} \quad (4.2)$$

Naturally, the question arises to proceed in a way analogous to the foregoing considerations and to

- (i) maximize β with respect to a set (M_1, M_2, M_3, M_4) according to the different diversion possibilities such that the sum

$$M_1 + M_2 + M_3 + M_4 = M$$

takes a predetermined value.

- (ii) minimize β with respect to the distribution of effort and furthermore with respect to the distribution of false alarm probabilities α_i such that a predetermined overall false alarm probability α according to eq. (4.2) is guaranteed.

Obviously this program is by far too complicated to be carried through analytically.

One point has to be made first: The effort for the performance of D_1 -statistics is measured in costs (for analyses), the effort for the performance of the D_2 -statistics is measured in inspector man-days in the plant. In principle, one could translate the latter effort into costs, too, however, as the number of inspector man-days in the plant is an important quantity for other reasons, these two measures for effort should be kept separated. This means that in the case one deviates from the 100 % coverage (where the two D-statistics play no role) the reduction of effort has to be considered in terms of the two parameters cost and man-days; this means furthermore, that no optimization between the two kinds of D-statistics has to be performed.

A severe problem is represented by the fact that the different random components in eqs. 4.1 and 4.2 are not independent because the same measurements are used in the case of the data verification as well as in the case of the material balance establishment. As there exists in the moment no method to treat this problem analytically and as because of the complexity of the problem that the different dependencies cancel each other at least partially eqs. (4.1) and (4.4) are without further argumentation written in the form

$$\beta = \text{prob} \{ \text{MUF}_1 \leq s_1 \wedge \text{MUF}_2 \leq s_2 | M_1 + M_2 \} \cdot \text{prob} \{ D_1 \leq s_1 | M_3 \} \cdot \text{prob} \{ D_2 \leq s_2 | M_4 \} \quad (4.3)$$

$$1 - \alpha = \text{prob} \{ \text{MUF}_1 \leq s_1 \wedge \text{MUF}_2 \leq s_2 | 0 \} \cdot \text{prob} \{ D_1 \leq s_1 | 0 \} \cdot \text{prob} \{ D_2 \leq s_2 | 0 \} \quad (4.4)$$

From (4.4) one obtains

$$1 - \alpha = (1 - \alpha_1) \cdot (1 - \alpha_2) \cdot (1 - \alpha_3) \quad (4.5)$$

Here α_1 is the common false alarm probability for the two MUF-tests, and α_2 and α_3 are the false alarm probabilities for the two D-statistics.

Having the problem formulated in this way one could proceed in the following way

- (i) A certain effort in form of costs for analysis and inspector man-days in the plant is fixed.
- (ii) The error second kind probability β according to eq. (4.3) is maximized with respect to the variables M_1, M_2, M_3, M_4 , such that the sum

$$M_1 + M_2 + M_3 + M_4 = M$$

takes a value fixed before.

- (iii) This maximized error second kind probability β is minimized with respect to the false alarm probabilities $\alpha_1, \alpha_2, \alpha_3$ such that the boundary condition (4.5) is fulfilled for a given α .

These optimization procedures are to be understood in such a way that the 'internal optimizations' which were the subject of the foregoing papers are carried through before.

Although this procedure seems to be very reasonable from the mathematical point of view there is also the argument of 'practicability'. This means that one should not develop too complicated formulae as they will cause difficulties in the application. Therefore, from a practical point of view one should choose

$$\alpha_1 = \alpha_2 = \alpha_3 = 1 - \sqrt[3]{1-\alpha}$$

(4.6)

$$M_1 + M_2 = M_3 = M_4 = \frac{M}{3}$$

and calculate the error second kind probability β , eq. 4.3, for this alternative hypothesis and a given effort. However, it should be tried, at least numerically, to figure out in what extent one deviates from the saddlepoint if one proceeds this way.

A final remark shall be made to the question of the global parameters: false alarms probability, total amount M to be diverted and effort (the global probability of detection is considered here as the determinant).

The global false alarm probability could be treated in principle as a determinant, too /5/, but for practical reasons one wants to treat it as a boundary thus, it is fixed before. (The same holds for the number of inventory periods per reference time which could be considered as the fifth global parameter.)

The total amount M assumed to be diverted per reference time has been subject of broad discussions; it seems best to vary this in order to have a feeling for 'reasonable' amounts. The single amounts M_i which refer to the single diversion strategies are determinants thus, the question of their values which had been raised at the beginning of this study is answered in this context.

The effort necessary for a single plant is only fixed in broad terms; therefore, it seems to be reasonable to vary this quantity, too.

As a result of these considerations the optimization study should end in a figure where the optimized probability of detection $1-\beta$ is plotted versus the total amount M assumed to be diverted, with the effort (costs plus inspector man-days) as parameter.

References

- /1/ The Structure and Content of Agreements between the Agency and States Required in Connection with the Treaty on the Non-Proliferation of Nuclear Weapons.
IAEA-Document INFCIRC/153
May 1971
- /2/ R. Avenhaus
Application of Theory of Games to Safeguards Problems. Contribution to the Symposium on Implementing Nuclear Safeguards.
Kansas State University, Manhattan, Kansas, USA, October 1971
- /3/ K.B. Stewart
A New Weighted Average.
Technometrics 12, pp. 247-258 (1970)
- /4/ R. Avenhaus, H. Frick
To be published
- /5/ R. Avenhaus
To be published
- /6/ K.B. Stewart
A Cost-Effectiveness Approach to Inventory Verification.
Proceedings of the IAEA-Symposium on Safeguards Techniques in Karlsruhe.
Vol. II, pp. 387-409 (1970)

```

COMPILER OPTIONS - NAME= MAIN,OPT=02,LINECNT=60,SIZE=0000K,
SCURCF,EBCDIC,NCLIST,NODECK,LCAD,MAP,NOEDIT,ID,NOXREF
ISN 0002      1000 FORMAT (5E14.7)
ISN 0003      2222 FORMAT (1H0,5X,E14.7,7X,E14.7,7X,E14.7,7X,E14.7,7X,E14.7)
ISN 0004      5000 FORMAT (1H ,5X,E14.7,7X,E14.7,7X,E14.7,7X,E14.7,7X,E14.7,7X,E14.7)
ISN 0005      2221 FORMAT (1H1,11X,'XN',20X,'XK',19X,'R',20X,'ML',19X,'RO')
ISN 0006      5010 FORMAT (1H0,11X,'R',18X,'L1ALFA',16X,'ALPHA',18X,'MU',16X,'PROBOB'
1)
ISN 0007      5020 FORMAT (112)
ISN 0008      DIMENSION B(100)
ISN 0009      DIMENSION C(100)
ISN 0010      DIMENSION E(100)
ISN 0011      DIMENSION P(100)
ISN 0012      DIMENSION T(200)
ISN 0013      DIMENSION EXK(100)
ISN 0014      DIMENSION EXN(100)
ISN 0015      DIMENSION PX(100)
ISN 0016      DIMENSION TSTEP(100)
ISN 0017      DIMENSION SUMUP(200)
ISN 0018      DIMENSION SUMDOW(200)
ISN 0019      DIMENSION PRCBAB(100)
ISN 0020      REAL*8 ALFDBL
ISN 0021      REAL MU
ISN 0022      READ(5,5020) NUMB
ISN 0023      DO 500 KKK=1,NUMB
ISN 0024      READ(5,1000) XN,ALPHA,YR,YML,RC
ISN 0025      MAXXK=IFIX(XN)
ISN 0026      DO 600 IXK=1,MAXXK,10
ISN 0027      R=YR
ISN 0028      MU=YMU
ISN 0029      XK=IXK
ISN 0030      WRITE(6,2221)
ISN 0031      WRITE(6,2222) XN,XK,R,ML,RC
ISN 0032      AMU=MU
ISN 0033      SIGMA=1.0
ISN 0034      U=0.0
ISN 0035      TOTALM=AMU*R
ISN 0036      MAXR=MAXXK
ISN 0037      DO 400 IKI=1,MAXR
ISN 0038      R=FLOAT(IKI)
ISN 0039      MU=TOTALM/R
ISN 0040      K=IKI
ISN 0041      IF (XK .LE. R) J=XK
ISN 0043      IF (R .LE. XK) J=R
ISN 0045      XM=XK+R-XN
ISN 0046      IF (XM .LE. 0.0) XM=0.0
ISN 0048      M=IFIX(XM)
ISN 0049      XM1=XM+1.0
ISN 0050      M1=M+1
ISN 0051      TEST=1.0E-70
ISN 0052      AA=1.0-ALPHA
ISN 0053      ALFDBL=AA
ISN 0054      U1ALFA=UP(ALFDBL,U,SIGMA)
ISN 0055      IF (XM .GT. 0.0) GO TO 720
ISN 0057      P(1)=1.0-XK/XN
ISN 0058      PX(1)=P(1)
ISN 0059      IF (K .LT. 2) GO TO 40
ISN 0061      DO 10 I=2,K

```

Tab.1a : Main program for the probability of detection

$$\text{PROBOB} = 1 - \sum_{XL = \max(0, XK+R+XN)}^{\min(XK, R)} \Phi \left(\text{UP}(1-\text{ALPHA}, 0, 1) - \frac{XL}{\sqrt{XN}} - \frac{MU}{RO} \right) \cdot \frac{\binom{R}{XL} \binom{XN-R}{XK-XL}}{\binom{XN}{XK}}$$

```

ISN 0062      XI=FLOAT(I)-1.0
ISN 0063      PX(I)=(1.0-XK/(XN-XI))
ISN 0064      IF(PX(I) .LT. 0.0) PX(I)=0.0
ISN 0066      P(I)=PX(I)*P(I-1)
ISN 0067      10 CONTINUE
ISN 0068      40 CONTINUE
ISN 0069      IF(P(K) .LT. 0.0) P(K)=0.0
ISN 0071      C(I)=P(K)
ISN 0072      BB=-U1ALFA/SCRT(2.0)
ISN 0073      B(I)=0.5+0.5*ERF(BB)
ISN 0074      IF(B(I) .LT. TEST) B(I)=0.0
ISN 0076      PRCBAB(I)=C(I)*B(I)
ISN 0077      GO TO 730
ISN 0078      720 CONTINUE
ISN 0079      FIFF=XN-R
ISN 0080      IFFA=IFIX(FIFF)
ISN 0081      IF(XK .LT. XM) DIFF=XM-XK
ISN 0083      IF(XK .GT. XM) DIFF=XK-XM
ISN 0085      IF(XK .EQ. XM) DIFF=0.0
ISN 0087      IF(XK .LT. XM) SUMUP(1)=XK+1.0
ISN 0089      IF(XK .GT. XM) SUMUP(1)=XM+1.0
ISN 0091      IF(XK .EQ. XM) SUMUP(1)=1.0
ISN 0093      SUMDOWN(1)=R+1.0
ISN 0094      IDIFF=IFIX(IDIFF)
ISN 0095      T(1)=SUMUP(1)/SUMDCN(1)
ISN 0096      IF(IFFA .GE. IDIFF) IFF=IFFA
ISN 0098      IF(IFFA .LT. IDIFF) IFF=IDIFF
ISN 0100      IF(IFF .LT. 2) GO TO 11
ISN 0102      DO 11 MUS=2,IFF
ISN 0103      SUMUP(MUS)=SUMUP(MUS-1)+1.0
ISN 0104      SUMDOWN(MUS)=SUMDOWN(MUS-1)+1.0
ISN 0105      IFFIA=IFFA-MUS
ISN 0106      IFIFFA=IDIFF-MUS
ISN 0107      IF(IFIFFA .LT. 0) SUMLP(MUS)=1.0
ISN 0109      IF(IFFIA .LT. 0) SUPDCN(MUS)=1.0
ISN 0111      T(MUS)=T(MUS-1)*SUMLP(MUS)/SUPDCN(MUS)
ISN 0112      IF(T(MUS) .LT. TEST) T(MUS)=0.0
ISN 0114      11 CONTINUE
ISN 0115      DO 22 JT=1,M
ISN 0116      C(JT)=0.0
ISN 0117      B(JT)=0.0
ISN 0118      PRCBAB(JT)=0.0
ISN 0119      22 CONTINUE
ISN 0120      C(M1)=T(IFF)
ISN 0121      IF(IFF .LT. 1) C(M1)=1.0
ISN 0123      BB=(MU*XM/SQRT(XK*RC*RC)-U1ALFA)/SQRT(2.0)
ISN 0124      B(M1)=0.5+0.5*ERF(BB)
ISN 0125      IF(C(M1) .LT. TEST) C(M1)=0.0
ISN 0127      IF(B(M1) .LT. TEST) B(M1)=0.0
ISN 0129      IF(C(M1) .EQ. 0.0) GO TO 710
ISN 0131      TESTT=TEST/C(M1)
ISN 0132      IF(B(M1) .LT. TESTT) B(M1)=0.0
ISN 0134      710 CONTINUE
ISN 0135      PRCBAB(M1)=C(M1)*B(M1)
ISN 0136      730 CONTINUE
ISN 0137      MM=M+2
ISN 0138      JJ=J+1
ISN 0139      IF(JJ .LT. MM) GO TO 60

```

Tab.1a (continued)

```

ISN 0141      DO 1 L=MM,JJ
ISN 0142      XL=FLCAT(L)-1.0
ISN 0143      IL=L-1
ISN 0144      BB=(MU*XL/SQRT(XK*RC*RC)-UIALFA)/SQRT(2.0)
ISN 0145      B(L)=C.5+0.5*ERF(BB)
ISN 0146      CC=XL*(XN-R-XK*XL)
ISN 0147      IF (CC .EQ. 0.0) GO TO 50
ISN 0149      CC=(R-XL+1.0)*(XK-XL+1.0)/CC
ISN 0150      IF(CC .LT. TEST) CC=1.0
ISN 0152      C(L)=C(L-1)*CC
ISN 0153      GO TO 70
ISN 0154      50 EXN(1)=XN+1.0
ISN 0155      EXK(1)=XK+1.0
ISN 0156      E(1)=EXN(1)/EXK(1)
ISN 0157      II=XN-XK
ISN 0158      DO 60 I=2,II
ISN 0159      EXN(I)=EXN(I-1)+1.0
ISN 0160      EXK(I)=EXK(I-1)+1.0
ISN 0161      60 E(I)=E(I-1)*EXN(I)/EXK(I)
ISN 0162      C(L)=E(II)
ISN 0163      70 CONTINUE
ISN 0164      IF(C(L) .LT. 0.0) C(L)=0.0
ISN 0166      IF(C(L) .LT. TEST) C(L)=0.0
ISN 0168      IF(B(L) .LT. TEST) B(L)=0.0
ISN 0170      IF(C(L) .EQ. 0.0) GO TO 740
ISN 0172      TESTT=TEST/C(L)
ISN 0173      IF(B(L) .LT. TESTT) B(L)=0.0
ISN 0175      740 CONTINUE
ISN 0176      IF(XL .LE. XPI) GO TO 2
ISN 0178      PRCBAB(L)=PRCBAB(L-1)+C(L)*E(L)
ISN 0179      GO TO 5
ISN 0180      2 PRCBAB(L)=C(L)*E(L)
ISN 0181      5 CONTINUE
ISN 0182      1 CONTINUE
ISN 0183      80 PRCB0B=PROB0E(JJ)
ISN 0184      PRCB0E=1.-PRCB0B
ISN 0185      IF(R .GT. 1.0) GO TO 410
ISN 0187      WRITE(6,5010)
ISN 0188      410 CONTINUE
ISN 0189      WRITE(6,5000) R,UIALFA,ALPHA,MU,PRORCE
ISN 0190      400 CONTINUE
ISN 0191      600 CONTINUE
ISN 0192      500 CONTINUE
ISN 0193      STOP
ISN 0194      END

```

Tab.1a (continued)

COMPILER OPTIONS - NAME= MAIN,OPT=02,LINECNT=60,SIZE=0000K,
SOURCEF,EBCDIC,NCLIST,ACDECK,LCAD,MAP,ACFDBIT,IO,NOXREF

```

ISN 0002 REAL FUNCTION UP ( P, XM, SIG )
ISN 0003 LOGICAL K
ISN 0004 REAL *8 P, PO, P1, XU, X, X1, XC, DF, ABL0, ABL, F
ISN 0005 EPS = 1.E-17
ISN 0006 ABL = 2. / SQRT(3.14255265)
ISN 0007 PO = 2. * P - 1.
ISN 0008 P1 = DABS(PO)
ISN 0009 K = .FALSE.
ISN 0010 XU = 0.
ISN 0011 XO = 12.
ISN 0012 DO 10 I = 1, 100
ISN 0013 IF ( P1 - DERF(XC) .LE. C. ) GO TO 1
ISN 0015 XO = XC + 1.
ISN 0016 10 CONTINUE
ISN 0017 1 IF ( (XO - 13.) .GT. C. ) K = .TRUE.
ISN 0019 X = 1.
ISN 0020 DO 20 I = 1, 100
ISN 0021 DF = P1 - DERF(X)
ISN 0022 IF ( DABS(DF) .LE. EPS ) GO TO 11
ISN 0024 IF ( DF .GT. C. ) GO TO 2
ISN 0026 XO = DMIN1 (XC, X)
ISN 0027 GO TO 3
ISN 0028 2 XU = DMAX1 (XU, X)
ISN 0029 3 IF ( K ) GO TO 4
ISN 0031 ABL = ABL * DEXP(-X*X)
ISN 0032 H = DF / ABL
ISN 0033 X1 = X + H
ISN 0034 IF ( X1 .EQ. X ) GO TO 4
ISN 0036 IF ( X1 .LT. XU ) GO TO 4
ISN 0038 IF ( X1 .LT. XO ) GO TO 5
ISN 0040 4 X1 = 0.5 * ( XC + XU )
ISN 0041 IF ( X1 .EQ. X ) GO TO 11
ISN 0043 5 X = X1
ISN 0044 20 CONTINUE
ISN 0045 11 UP = X
ISN 0046 UP = SIG * UP * SQRT(2.) * XM
ISN 0047 IF ( PO .LT. C. ) UP = -UP
ISN 0049 RETURN
ISN 0050 END

```

Tab. 1b: Function subprogram for the inverse function
of the normal distribution function
(written by G.Nägele)

$$UP = \Phi^{-1} (\text{ARGUMENT}, 0, 1)$$

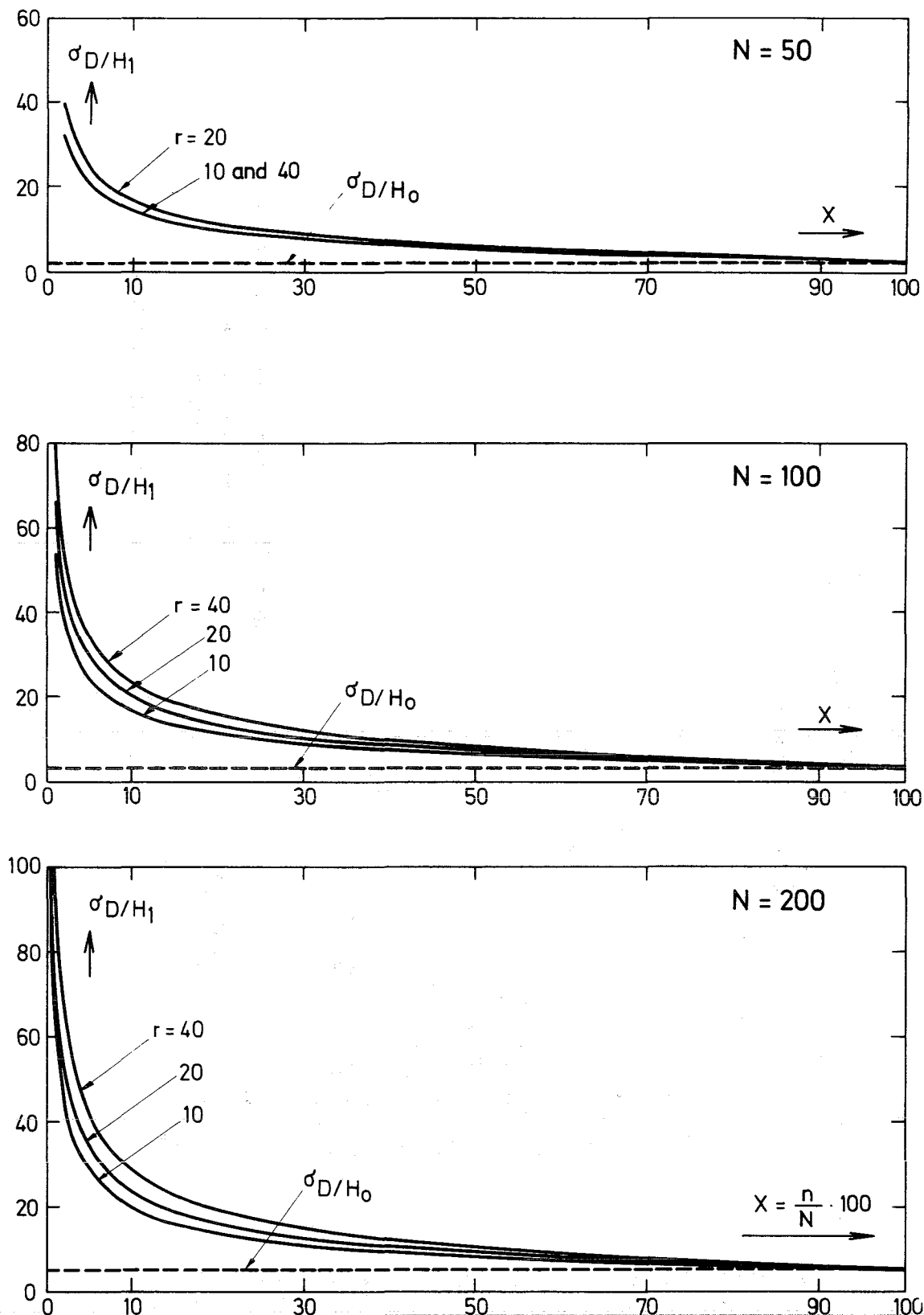

Fig. 1.1 Graphical representation of the standard deviation of the D-statistic under the alternative hypothesis H_1 ,

$$\sigma_{D/H_1} = N \cdot \left(\frac{\sigma_r^2}{n} + \sigma_s^2 + \mu^2 \cdot \frac{r}{N} \cdot \frac{N-r}{N} \cdot \left(\frac{1}{n} - \frac{1}{n} \cdot \frac{n-1}{N-1} \right) \right)^{1/2}$$
as a function of n for different values of r and N and $\mu = 1.44$, $\sigma_r = 0.3271$, $\sigma_s = 0.1$

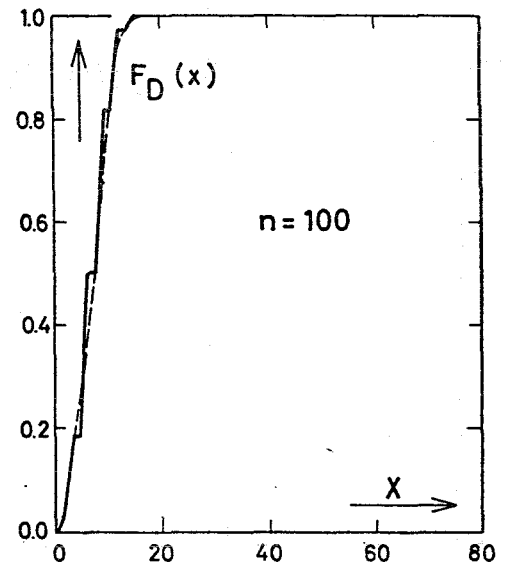
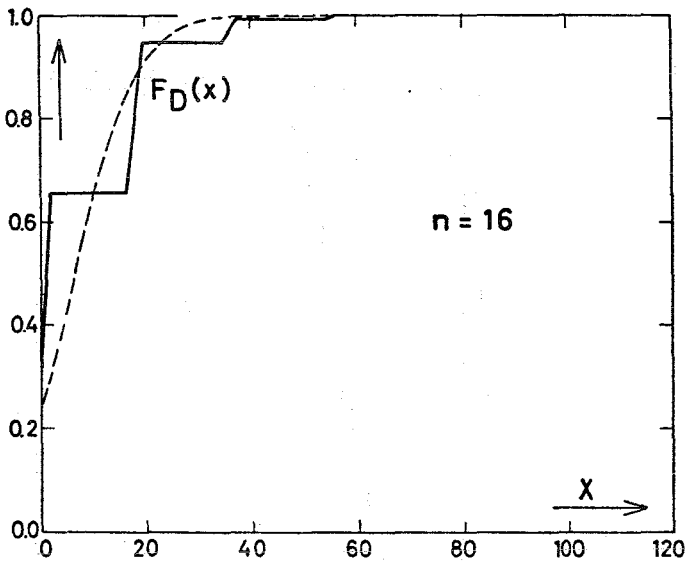
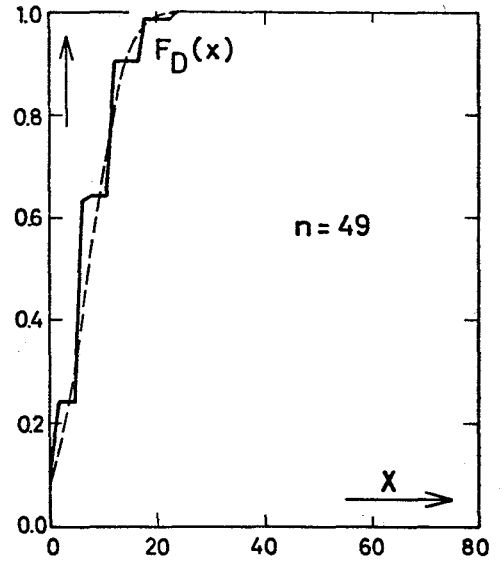
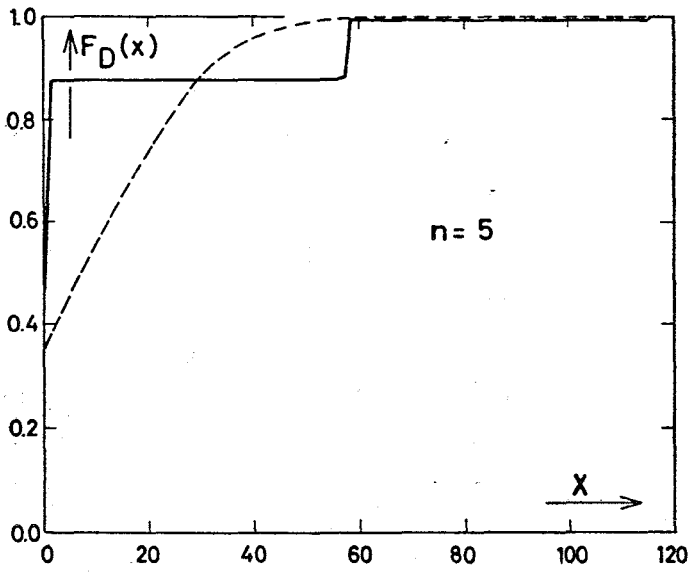

Fig. 1.2 Distribution function $F_D(x)$ of the D-statistics,

$$F_D(x) = \sum_{l=\max(0, n+r-N)}^{\min(n, r)} \phi\left(\frac{x - \frac{N \cdot \mu \cdot l}{n}}{\sqrt{\frac{\sigma_r^2}{n} + \sigma_s^2}}\right) \cdot \frac{\binom{r}{l} \binom{N-r}{n-l}}{\binom{N}{n}}$$

and its approximation by the normal distribution (dashed curves) for $N = 200$, $\mu = 1.44$, $\sigma_r = 0.002$, $\sigma_s^2 = 0$, $r = 5$ and different values of n .

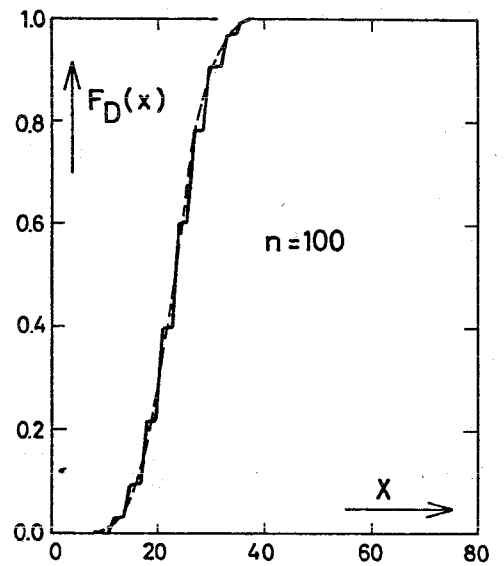
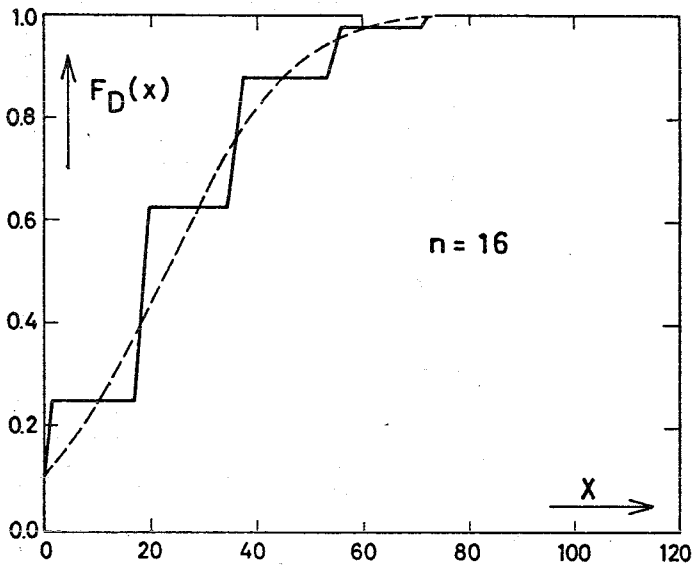
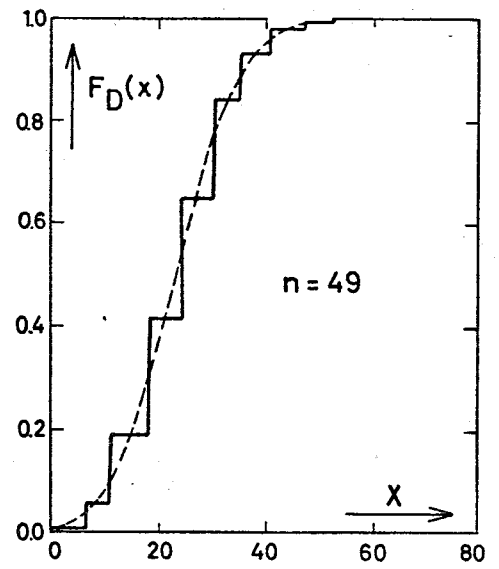
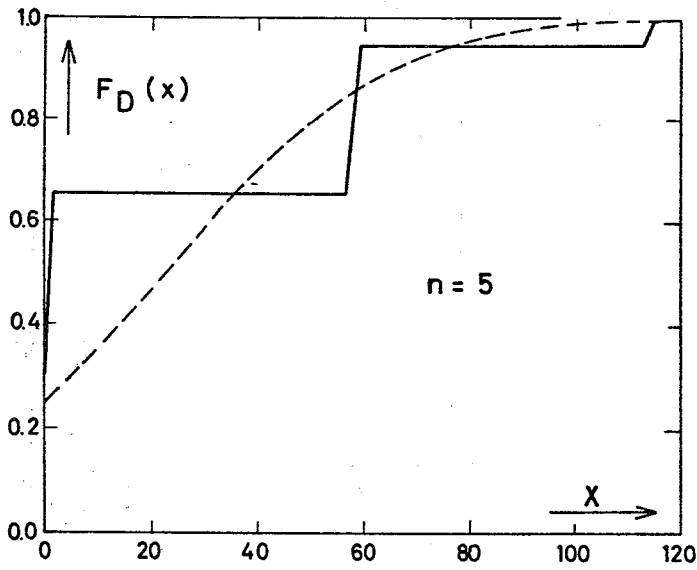

Fig. 1.3 Distribution function $F_D(x)$ of the D-statistics and its approximation by the normal distribution (dashed curves) for $N = 200$, $\mu = 1.44$, $\sigma_r = 0.002$, $\sigma_S^2 = 0$, $r = 16$ and different values of n .

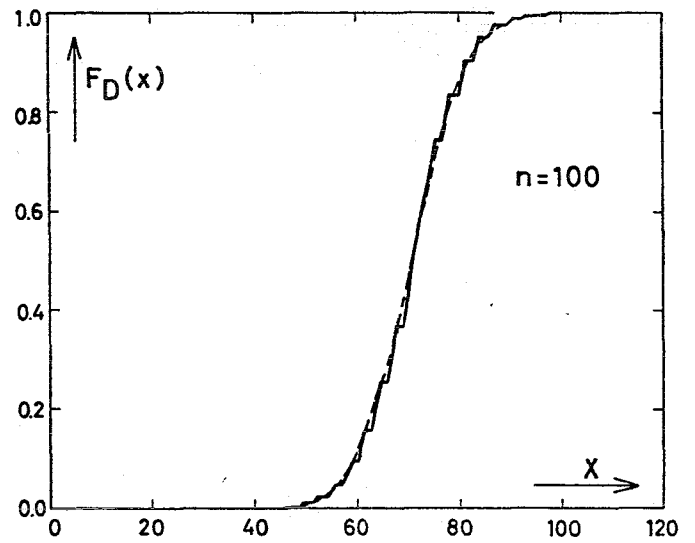
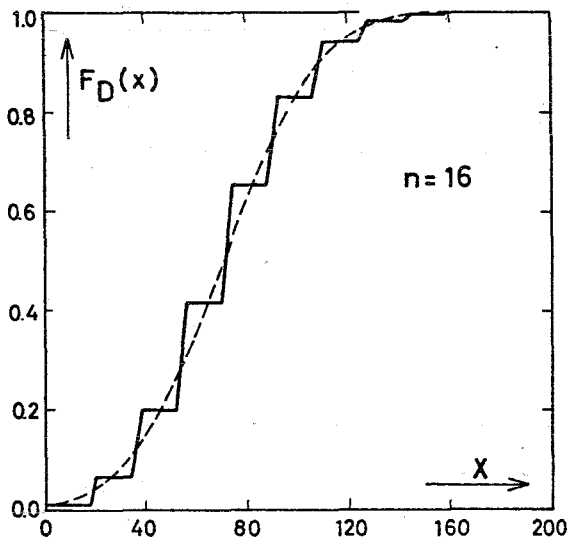
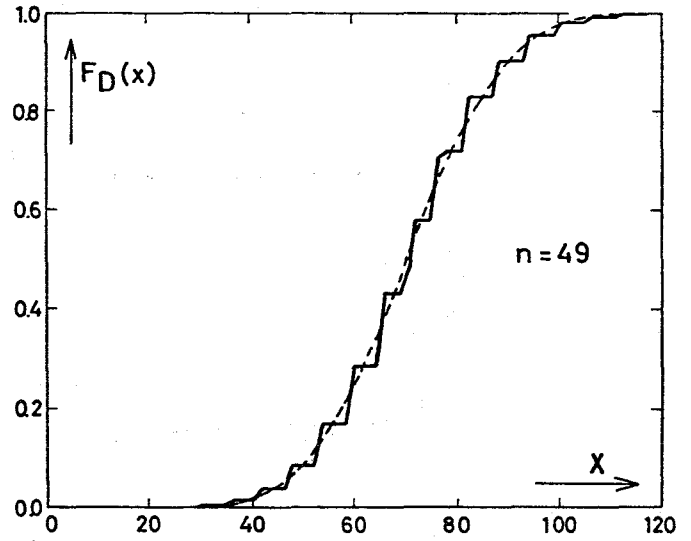
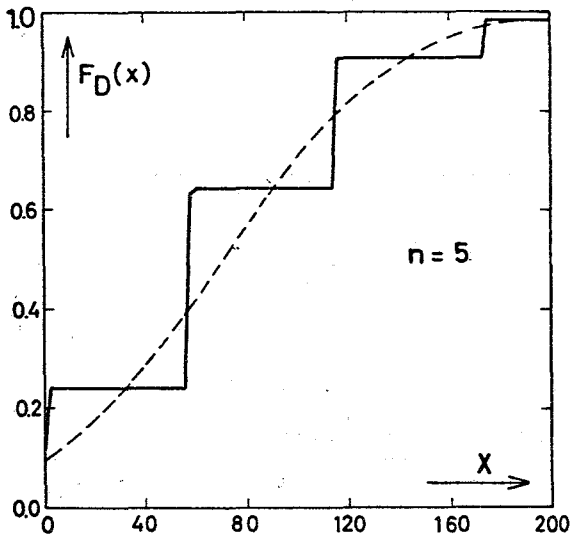

Fig. 1.4 Distribution function $F_D(x)$ of the D-statistics and its approximation by the normal distribution (dashed curves) for $N = 200$, $\mu = 1.44$, $\sigma_r = 0.002$, $\sigma_S^2 = 0$, $r = 49$ and different values of n .

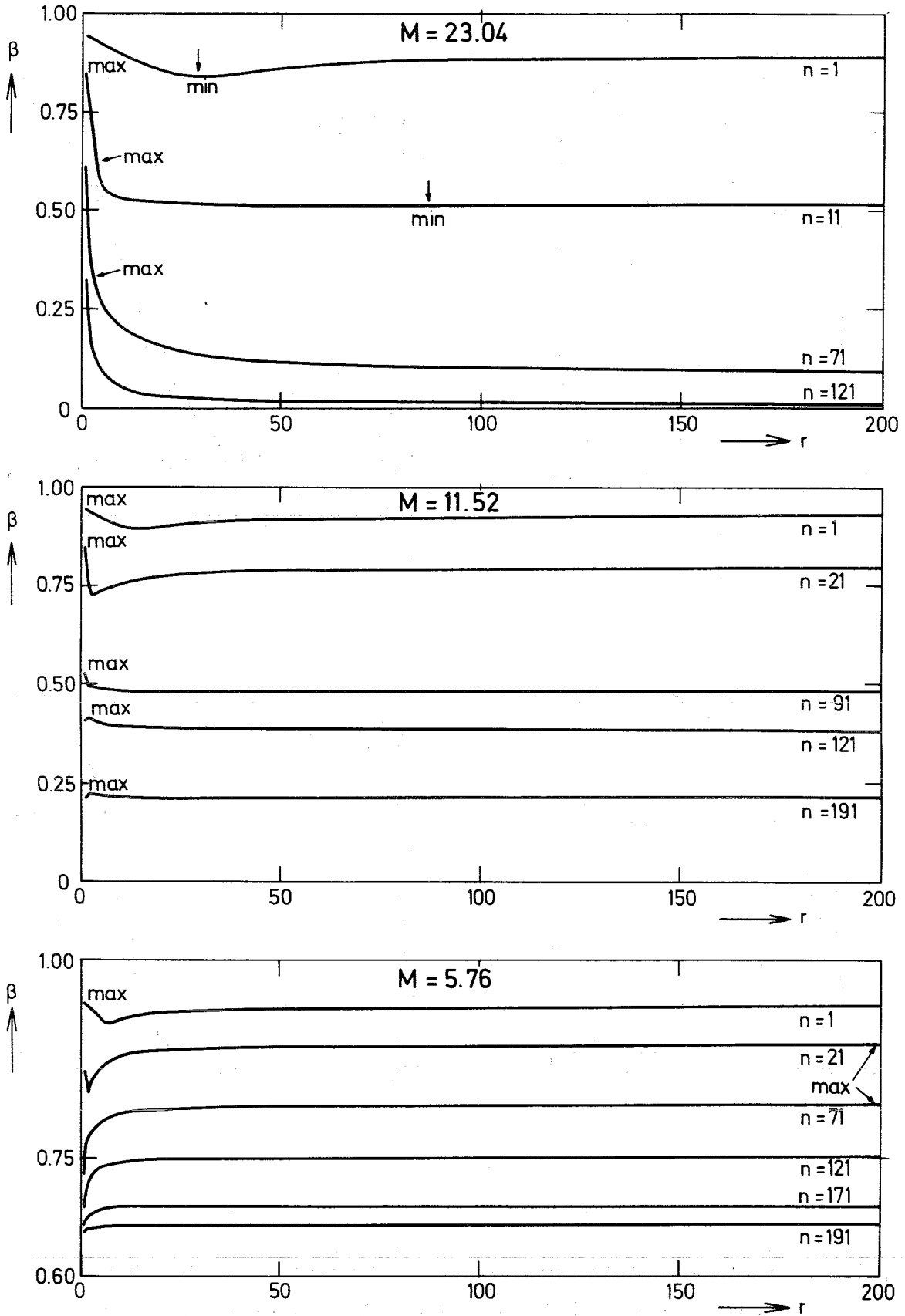

Fig. 1.5 Probability of the error of the second kind ,

$$\beta = \sum_l \Phi \left(U_{1-\alpha} - \frac{l}{\sqrt{n}} \cdot \frac{\mu}{\sigma} \right) \frac{\binom{r}{l} \binom{N-r}{n-l}}{\binom{N}{n}}$$

for fixed $M = \mu \cdot r$ as a function of r , with n as parameter, and $N=200$, $\sigma=0.3271$, $\alpha = 0.05$

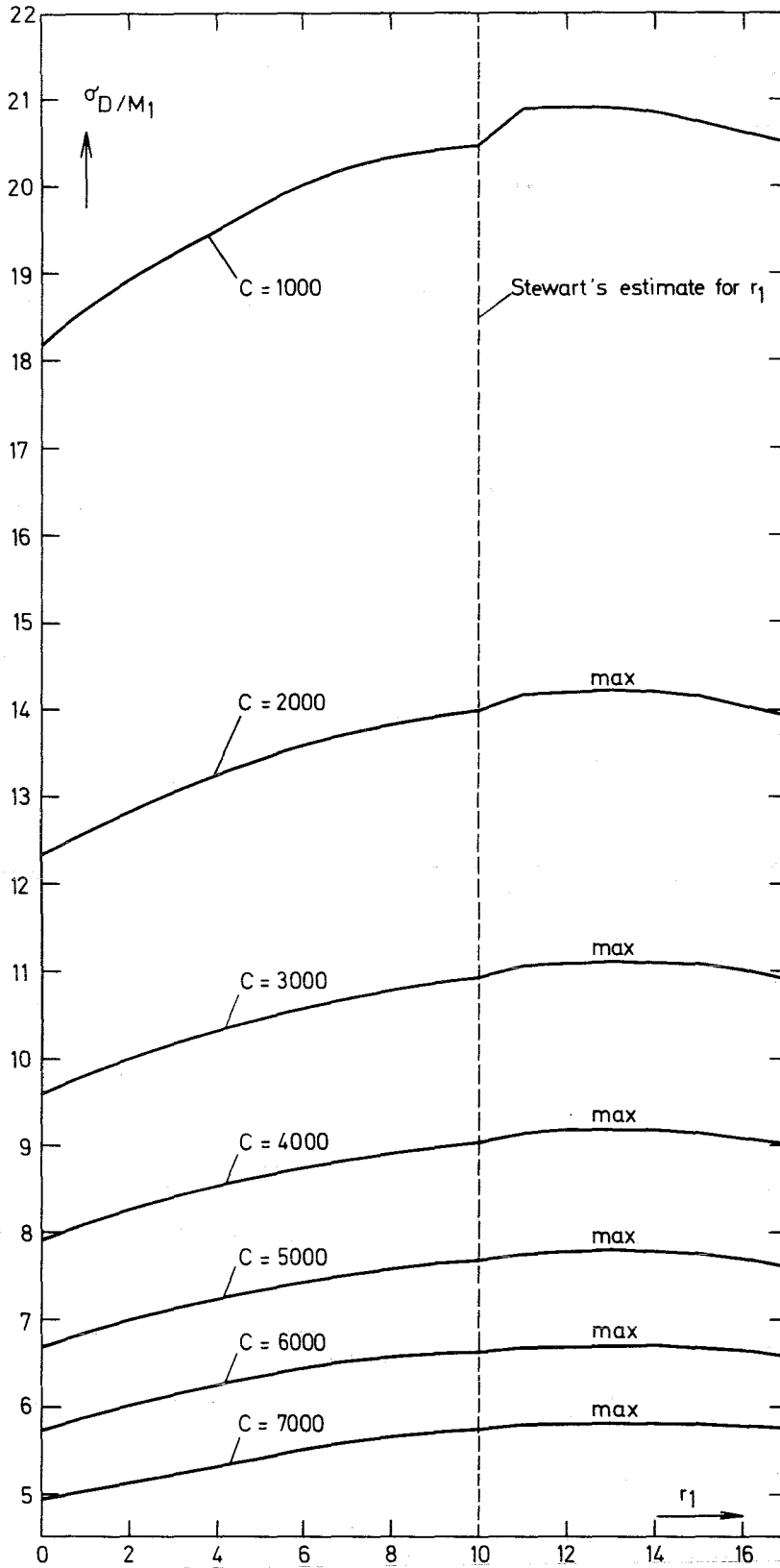

Fig.1.6 Standard deviation, optimized with respect to the inspector's strategy.

$$\sigma_{D/H_1}^2 = \frac{1}{C} \left(\sum_i \sqrt{\epsilon_i} \cdot S_i \right)^2 - \sum_i \mu_i^2 \cdot \frac{r_i}{N_i} \cdot \frac{N_i - r_i}{N_i}$$

$$\text{where } S_i^2 = N_i^2 \left(\sigma_{r_i}^2 + \mu_i^2 \cdot \frac{r_i}{N_i} \cdot \frac{N_i - r_i}{N_i} \right)$$

as a function of number of falsified batches r_1 in the first class, with effort C as parameter ($C_{\max} = 7400$, $M = 23.4$)

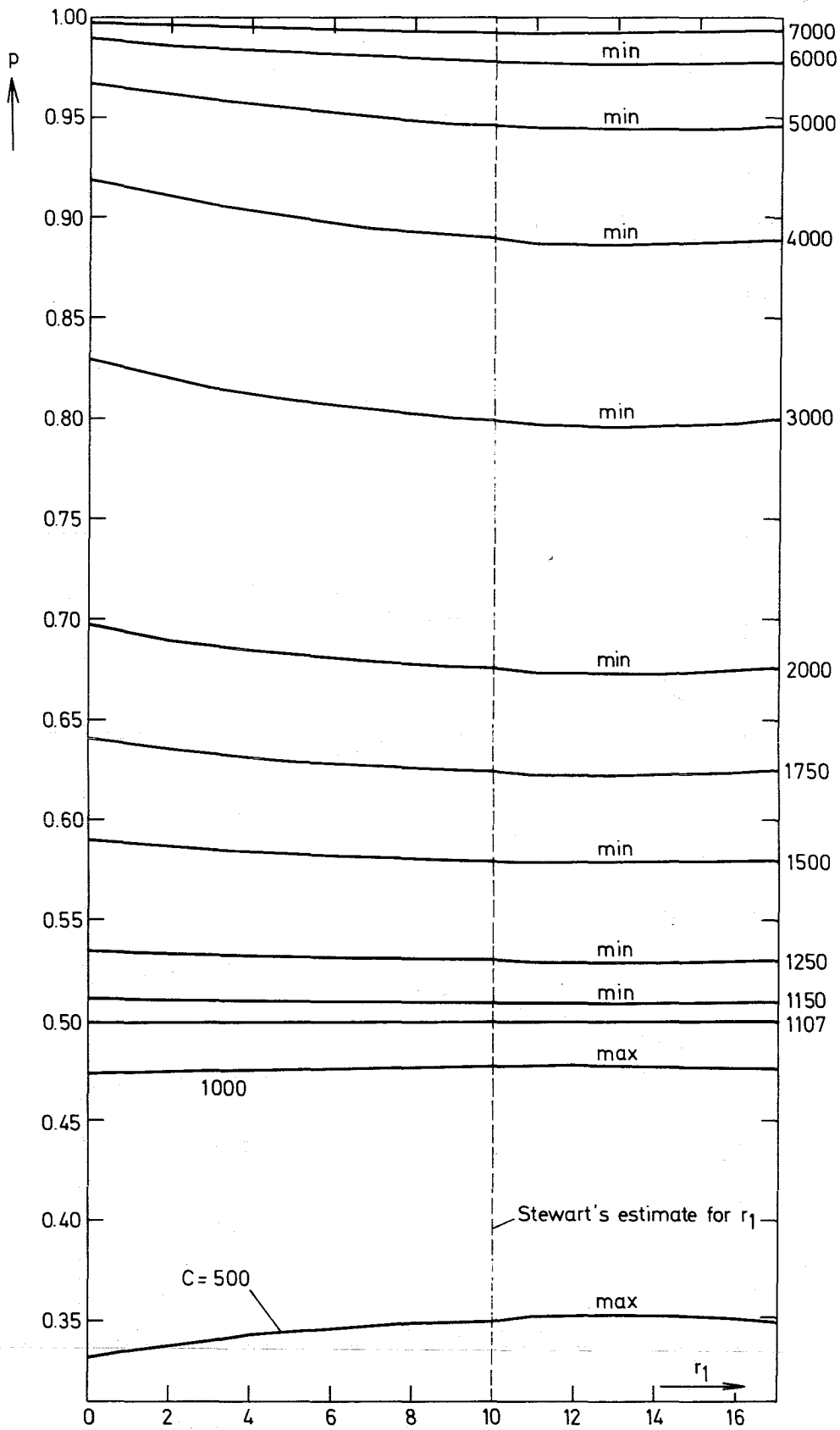

Fig.1.7 Probability of detection $p = \Phi \left(\frac{M - u_{1-\alpha} \cdot \sigma_{D/H_0}}{\sigma_{D/H_1}} \right)$

as a function of number of falsified batches r_1 in the first class, with effort C as parameter ($C_{max} = 7400$, $M = 23.4$, $\alpha = 0.05$)

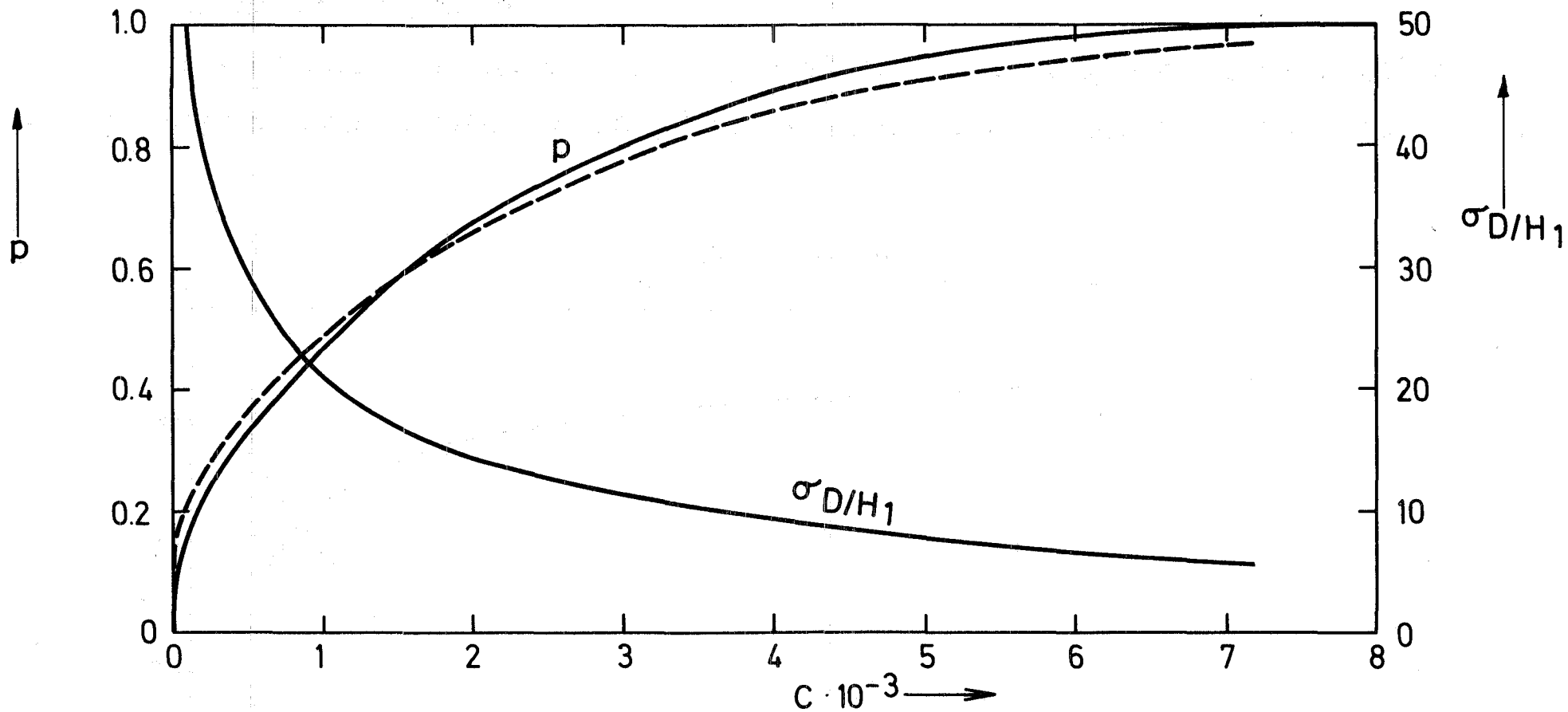

Fig. 1.8 Optimum of the standard deviation and optimal guaranteed probability of detection as a function of total effort for $M=23.4$, $\alpha = 0.05$. Dashed curve calculated with the approximate formula

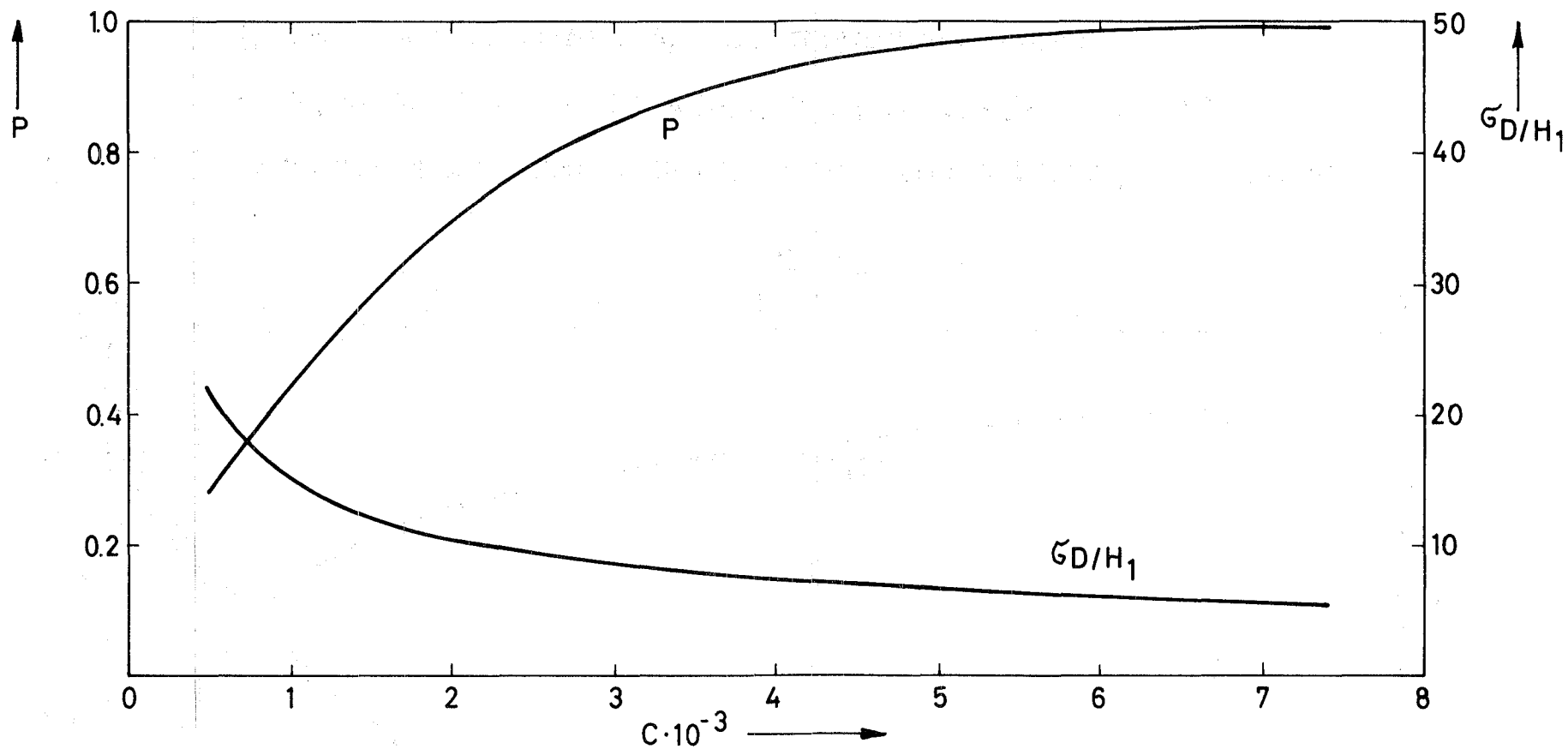

Fig. 1.9 Optimal guaranteed probability of detection and standard deviation as a function of total effort for $M=23.4$ $\alpha=0.05$ with the data of Stewart's example, calculated according to (3-15)

Chapter II Data Collection for the Reference Plants

1.1 Plant Data

1.1.1 General (Site, flow scheme, capacity)

The West Valley plant of Nuclear Fuel Services (NFS) is about 30 miles south of Buffalo, New York. The plant reprocesses spent fuel elements on the basis of the Purex solvent extraction process. A flow scheme of the plant is given in Fig. 2.1.

The capacity /1/ of the plant is 300 t low enriched uranium per year (in the form of low enriched UO_2 or U metal). This means 1000 kg low enriched uranium per day, if one takes 300 working days per year.

Alternatively the plant is able to process:

- 500 kg U plus Th/day; or
- 800 kg U-Me alloy/day; or
- 400 kg U-Zr and U-Al plus cladding/day

The capacity is different from the actual average throughput (see section 1.5).

For the purposes of this work only the cost of uranium processing is considered.

1.1.2 Input /1/

The spent fuel elements to be processed must be cooled 150 days before processing.

The base line process is thought for low enriched UO_2 in stainless steel or Zr alloy tubes. With only modification of the head-end treatment natural uranium fuel clad in aluminium can be processed.

The element to be processed is first removed from the storage-pool can, placed in a fixture on the inspection table and marked for sawing. The element is then transferred to the saw table; the scrap metal cutoff is taken in scrap buckets to the general-purpose cell for eventual burial. The fuel bundle is pushed by a ram out of its casing into a shear-feed magazine, and the magazine is transferred to the shear. The chopped fuel is discharged through a chute into baskets in the GPG.

The chopping operation, which can be operated manually or automatically can be carried out in an inert atmosphere by purging feed magazine, shear chamber, discharge chute and hydraulically driven chamber. The hydraulically-driven shear is automatically stopped by a detector sensing when the chopped-fuel basket is filled. Another detector stops the shear in case of a jam in the discharge chute.

Chopped-fuel baskets are loaded into the dissolver in the GPG by a crane. The amounts of fuel and acid charged to the dissolver are adjusted to yield a U-235 concentration that is approximately 50 % of the critical concentration.

The solution is mixed by an air sparger and heated by steam. Dissolution is completed in less than 12 hours, as indicated by levelling out of off-gas pressure, temperature and specific gravity. Recorders and alarms are also provided for liquid level, pot temperature and pressure. Steam to the heating jacket is shut off and cooling water is introduced to the dissolver automatically if the dissolver approaches atmospheric pressure.

Off-gases given off during dissolution are put through a scrubber, then heated to 200°C and the iodine absorbed on silver-nitrate-coated Berl saddles. The gas is cooled, filtered, added to the general ventilation system, filtered further and discharged to the stack.

Dissolver solution and rinses are collected in the accountability and feed-adjustment tank (3D-1), which is equipped with heating and cooling coils, condenser, air sparger, liquid-level and specific-gravity instruments. Tank contents can be adjusted to feed specifications by evaporation or the addition of cold chemicals.

1.1.3 Product /4/

Low enriched U-product (uranium nitrate) is loaded into a tank trailer and shipped in quantities of about 4.2 metric tons of uranium per shipment. (High enriched U-product is collected in glass raschig ring product vessels and loaded into 10-litre bottles which are packed in birdcages for shipment.)

The recovered Pu-product (plutonium nitrate) is stored in geometrically safe tanks from which it is loaded into 10-litre bottles. Pu is packaged in birdcages in a manner similar to high enriched U. Each 10-litre bottle contains about 2-3 kg of Pu. Shipments of Pu are scheduled when either 20 or more bottles of packaged product are in storage or at the end of each campaign.

1.1.4 Losses. Recycling

Two types of losses are considered here:

- (i) Liquid waste;
- (ii) Hull Losses.

(Solid waste from the laboratory etc. is not considered to be of importance in this connection.)

From Ref. /3/, Vol. I, page 45 (Table 3.8) and /6/, page 8, it is assumed that following numbers are representative: Total losses amount to 1 % of input; liquid waste 0.9 % of input; hull losses 0.1 % of input. The amount of material which is recycled in the course of acid recycling can be neglected.

1.1.5 Representative campaigns, batch data

Actual NFS campaign data are available in references /3/, /4/, /5/ and /7/. On the basis of these data representative batch data have been developed which are given in Table 2.1 through Table 2.3.

Here, one campaign corresponds to one third of a core of a 1000 MWe LWR. This corresponds to 120 elements or 120 80 pins.

One basket filled with chopped pins corresponds to one dissolver filling which amounts to 4-5 fuel elements.

1.1.6 Inventory

Upper and lower limits of the Pu inventory during a running campaign are given in Fig. 2.3.

By means of rough estimates of the Pu content of the different tanks one can estimate the Pu inventory of the plant with an accuracy of about 10 %. The so-called in-process inventory determination method which uses an isotopic step function of the fissile material to be processed does not work very well in the case of the NFS plant as the Pu product tanks are too large. Thus, the step function disappears.

The only accurate method to determine the inventory of the plant is to perform a flush-out after the end of a campaign. According to different references /3/, /8/ it is assumed that the Pu inventory after a campaign amounts to about 1 kg Pu which is washed out and which is measured in the form of waste batches.

As there remains always a certain amount of Pu in the plant (plating out, etc.) it is assumed that the Pu inventory after the end of a campaign can be determined with an accuracy of ± 1 kg Pu (100 %).

The Pu gained in the course of the inventory taking is obtained in the form of 10 batches with 1000 l, each containing 100 g Pu. This Pu is measured like Pu product (amperometric titration). Volume is measured with the dip tube system.

The U inventory amounts to about 10 kg and can be measured with an accuracy of ± 1 kg.

1.2 Measurement System, Methods and Sampling Points

Input accountability

Input is measured in the input accountability tank (3 D-1) by means of

- volume determination (dip-tube system)
- concentration determination of a sample.

Additionally, the density is determined as the concentration is given in g Pu(U)/g solution. However, as long as the density of the solution in the tank is the same as in the sample one must not take into account the error of the density determination.

U product (/4/, p. 4)

The low enriched uranium product is sampled in tank 5 V-1. The product loadout quantities are based upon the net weight of the product solution and the sample results.

Pu product (/4/, p. 4)

The samples for product specifications and plutonium concentration analysis are drawn from the product storage tank (5 D-5 A,B). The product loadout quantities are based on the net product solution weight and the reported assay values.

It is to be noted that Pu is collected in one of the two plutonium product storage tanks until about 100 l have accumulated. This means that one representative sample is drawn for 10 plutonium product bottles together.

Waste

Liquid waste is collected in the central waste tank (7 D-10; change of the system compared to former arrangement). Measurement is based on volume determination (level indicator) and analysis of a sample which is drawn from the central waste tank.

Hulls /7/

The Pu and U content in the hulls is determined by

- weighing of the baskets (gross and tare)
- taking of samples of end and middle pieces
- analysis of samples for U and Pu content

Not all baskets are checked.

1.3. Safeguards Effort (100 %)

1.3.1 General remarks

- (i) 100 % inspection effort means that the inspectors spend the same effort as the operator, not more, e.g. if the operator does not measure all hull batches then the inspector must not measure all hull batches either.
- (ii) Inspection effort is divided into two parts: inspection effort spent in the plant (inspection man-hours) and costs for analyses (US\$) which are performed in laboratories separated from the plant in question.
- (iii) A total of half an inspector man-day is needed for the introduction of new inspection personnel per year.
- (iv) In the following all inspection efforts are given in net inspection hours. It is assumed that one inspector man-day corresponds to 5 net inspection hours.

1.3.2 Effort before accountability tank

Spent fuel elements arrive by truck (8 elements per truck) and are moved to the spent fuel storage. Safeguards effort per truck: 4 hours.

Fuel elements are identified in the pond; transport from pond to PMC is witnessed. Actual chopping and transfer of chopped pieces to the dissolver is witnessed (6 baskets correspond to one dissolver batch). All these procedures need one hour per input batch (with interruption).

1.3.3 Input accountability

Sparging needs 0.5-1 hour. However, no inspector must be present as there exist indirect methods to assure that sparging has taken place: paper records of level instrumentation.

By-passing would require a pipe which could be detected by inspection.

Volume measurement (dip-tube-system) needs 0.7 hours. Recalibration of volume measurement instrumentation is performed at the beginning of each inventory period. Three days for a group of 4 people are needed.

1-2 inspectors would be sufficient.

Time-table for the sampling procedure looks as follows:

15 min to get in
15 min to get sample bottles
15 min to bring the sample bottles into the sample station
15 min for sparging the tank
15 min for circulation
15 min to get out.
This means in total 1.5 hours.

Cost per analysis (U + Pu): 400 US\$.

1.3.4 Plutonium product

Time table for the sampling procedure (one set of samples for 10 Pu product bottles together).

30 min to get in
15 min to get sample bottles
30 min sparging + sampling
30 min to get sample bottles out
30 min to get out.

This means in total 2.25 hours sampling time. In case of unforeseeable events (contamination) the factor 2 may be possible.

Weighing of Pu product bottles is performed in a frequency of 8 bottles/day, that means 1 bottle/hour.

Cost of analysis: 200 US\$

Note: Random sampling of bottles in the storage is possible but complicated, see Ref. /13/. The interim storage has about 20 bottles.

1.3.5 Low enriched uranium product

Sampling (tanks 5 D-15 A and 15 B) needs about one hour.

Weighing (tank 5 V-1) represents a continuous process. The time needed to verify the tare weight and the gross weight is 10 min.

Cost per analysis: 80 US\$.

1.3.6 Waste

Volume determination in the central waste tank (7 D-10) is performed by reading the level indicator which needs practically no time. Sampling needs only 0.5 hours per sample as the sampling station is in the hot cell aisle of the laboratory. The effort for verification of an analysis is 2 hours per duplicate analysis.

1.3.7 Hulls

As the amount of material which remains in the hulls does not occur in the material balance which starts with the measurement of the accountability tank content, effort is only necessary for verifying that all hulls are buried. The effort for this procedure is 1 h/day.

In order to verify that the amount of material remaining in the hulls corresponds to the value reported by the operator it is assumed that it is sufficient to perform once per campaign a hull measurement for one basket, as controlled leading is very difficult. This means an effort of 4 h per campaign.

The possibility that buried drums with hulls are taken from the burial can be excluded.

1.3.8 Inventory

According to Ref. [3], Vol. I, page 34 an inventory at the end of a campaign needs in total 8 days. Activities of the inspector are

to verify volume determination
 sampling
 analysis of the samples in the laboratory

It is assumed that 20 inspector man-hours are necessary for the verification of an inventory taking.

REFERENCES

1. Plant Data, Measurement System, Effort
- /1/ T.L. Cramer, NFS: First Fuel reprocessor, Nucleonics, December 1966, pp 48-52
- /2/ S.C. Suda et al, Procedures Manual for Nuclear Material Accountability, NFS, April 1966
- /3/ R.P. Wischow, J.R. Clark, I.B. Roll, Safeguards Procedures Manual for the NFS Reprocessing Plant, Vols. I, II, III, USAEC Contract AT (38-1)-452, February 1967
- /4/ S.C. Suda, Nuclear Materials Management at NFS, Presented at 8th Annual Meeting of INMM, June 1967
- /5/ G.M. Daly, Safeguards Technical Practices for Irradiated Fuel Plants, Prepared for distribution at the IAEA Panel, March 1968
- /6/ B.W. Sharpe, IAEA Safeguards Inspection at NFS, Presented at 9th Annual Meeting of INMM, May 1968
- /7/ NFS, Safeguards Research and Development USAEC, Contract No. AT(38-1)-539, February 1970
- /8/ S.G. Suda, Evaluation of IAEA Safeguards Inspection at NFS, BNL 50228(T-567), March 1970
- /9/ B.W. Sharpe, et al, IAEA Safeguards Operations in the USA, Safeguards Symposium (IAEA, SM-133/104), July 1970
- /10/ Report of Working Group on Accuracy of Nuclear Material Accountancy and Technical Effectiveness of Safeguards, Vienna, 28-1 September 1972, IAEA/PL-488
- /11/ Nentwich, D., Gupta, D., Otto, H.E., Scheuerpflug, W., R+D work on Safeguarding the Input to a fuel reprocessing plant (accountability tank) KFK 1700
- /12/ Kraemer, R., Beyrich, W. Joint Integral Safeguards Experiment (JEX 70) at the Eurochemic Reprocessing Plant, Mol, Belgium KFK1100/EUR 4576e
- /13/ J.E. Cline, E.B. Nieschmidt, A.L. Connelly, E.L. Munir, A Technique for Assay of L-10 Bottles of Plutonium Nitrate, AEC Contract No. AT (10-1)-1230 (October 1970).

2. Isotopic correlations, in-process inventory

- /14/ Summary of FT-62 Working Group Meeting on 15 October 1959 and Test Status ACDA, Technical Report TR-18, November 1969
- /15/ D.E. Christensen, R.P. Matse, R.A. Schneider, W.C. Wolkenhauer, The Safeguards Value of Chemical Plant Measurements Relating to Burn-up Yankee Cores, V and VI, BNWL-1473, June 1970
- /16/ D.E. Christensen, R.A. Schneider, K.B. Stewart, Summary of Experience with the Use of Isotopic Correlation Safeguards Technique, BNWL-SA-4273, March 1973
- /17/ E. Drosselmeyer, R. Kraemer, A. Rota, User's Manual for the Application of the Dynamic Process Inventory Determination Using Isotopic Step Signals in Reprocessing Plants, KFK 1583, EUR 4727 G. May 1972
- /18/ Report of the Working Group on the Use of Isotopic Composition Data in Safeguards, Vienna, 11-14 April 1972, PL-487

Table 2.1

Throughput Data

U-Throughput/year [tons]	175
Pu-Throughput/year [tons]	1.75
Liquid Waste [% of input]	1
Hull Losses [% of input]	0.1
Number of campaigns/year	10
Number of working days/year	250

Table 2.2

Campaign Data

	U	Pu
<u>Input</u>		
Total input (tons)	17.5	0.175
Number of batches/campaign	25	
Batch volume (l)	4000	
Amount of material/batch (kg)	700	7.0
Batch to batch variation (%)	10	
<u>Product</u>		
Number of batches/campaign	5	76
Weight of one batch (kg)		15
Amount of material/batch (kg)	4000	2.28
Batch to Batch variation	10	10
<u>Liquid Waste</u>		
Number of batches/campaign		90
Volume/batch (l)		5000
Amount of material/batch (kg)	1.9	0.019
Batch to Batch variation		500
<u>Hulls</u>		
Number of batches/campaign		25.6
Amount of material/batch (kg)	0.7	0.007

Table 2.3

Measurement System for Pu

Stream	Measurement	Standard Deviation per Single Measurement		Effort/Single Measurement	
		Random (%)	Systematic (%)	Manhours (h)	Cost (US \$)
INPUT	Volume determination (diptube system)	0.35 ^{5/}	0.1 ^{5/}	0.7	-
	Sampling	1 ^{7/}	-	1.5	-
	Concentration determination (isotopic dilution)	0.6 ^{2/}	0.3 ^{2/}	-	400
PRODUCT	Weighing	0.02 ^{3/}	-	3	-
	Sampling	0.5 ^{4/}	-	2.25	-
	Concentration determination (amperometric titration + isotopic analysis)	0.4 ^{2/}	0.3 ^{2/}	-	200
LIQUID WASTE	Volume determination (level indicator)	5	5 ^{6/}	0.1	-
	Sampling	50 ^{8/}	-	0.5	-
	Concentration determination (TTA extraction & counting)	15 ^{2/}	10 ^{2/}	2	40
HULLS	Weighing	For the whole campaign: 20% of total residuals in the hulls ^{1/} .		1 h/day +	-
	Sampling			4 h/campaign	-
	Analysis				-

1/ Ref. [7], p. 63

2/ Ref. [10]

3/ Ref. [2]

4/ Ref. [12]

5/ Ref. [11]

6/ Constant systematic error for all measurements

7/ Worse than given by [4]

8/ Homogeneity problem

Table 2.4
Measurement System for U

Stream	Measurement	Standard Deviation per Single Measurement		Effort/Single Measurement	
		Random (%)	Systematic (%)	Manhours (h)	Cost (US \$)
INPUT	Volume determination (diptube system)	0.35	0.1	together with Pu	-
	Sampling	1	-	as above	-
	Concentration determination (isotopic dilution)	0.6	0.3	-	together with Pu
PRODUCT	Weighing	0.02	-	0.16	-
	Sampling	<u>1</u>	-	1	80
	Concentration determination (potentiometry)	0.2	0.2	-	80
LIQUID WASTE	Volume determination (diptube system)	5	5	together with Pu	-
	Sampling	-	-	as above	-
	Concentration determination (fluormetry)	20	5	2	100
HULLS	Weighing	For the whole campaign:		together	-
	Sampling	20% of total residuals		with Pu	-
	Analysis	in the hulls ^{1/}			

1/

Ref. [10]

Fig.2.1 NFS PROCESS DIAGRAM
MAJOR STREAMS

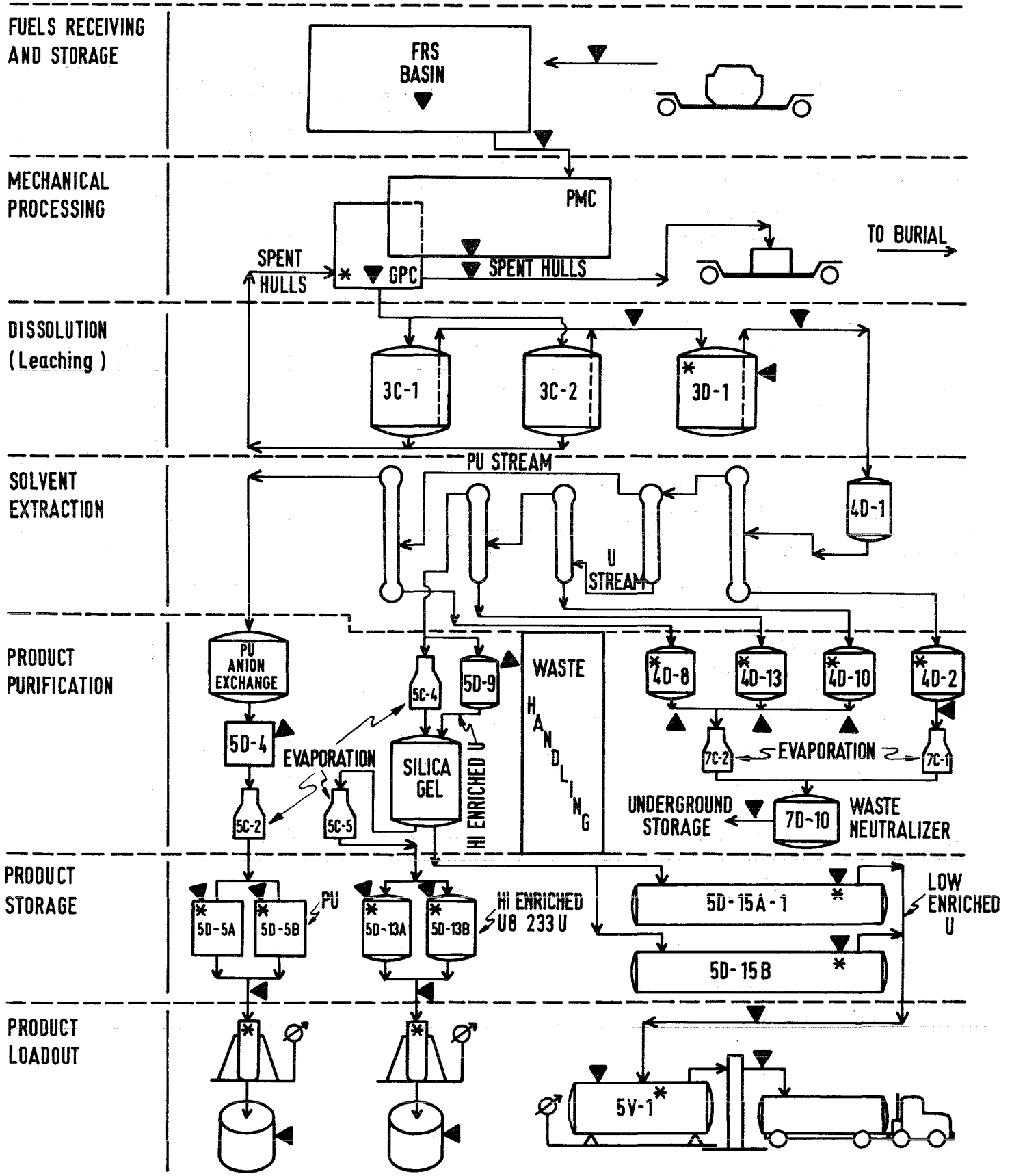

ACCOUNTABILITY POINTS *

SAFEGUARD CONTROL POINTS ▼

**Fig.2.2 NFS PROCESS DIAGRAM
AUXILIARY STREAMS**

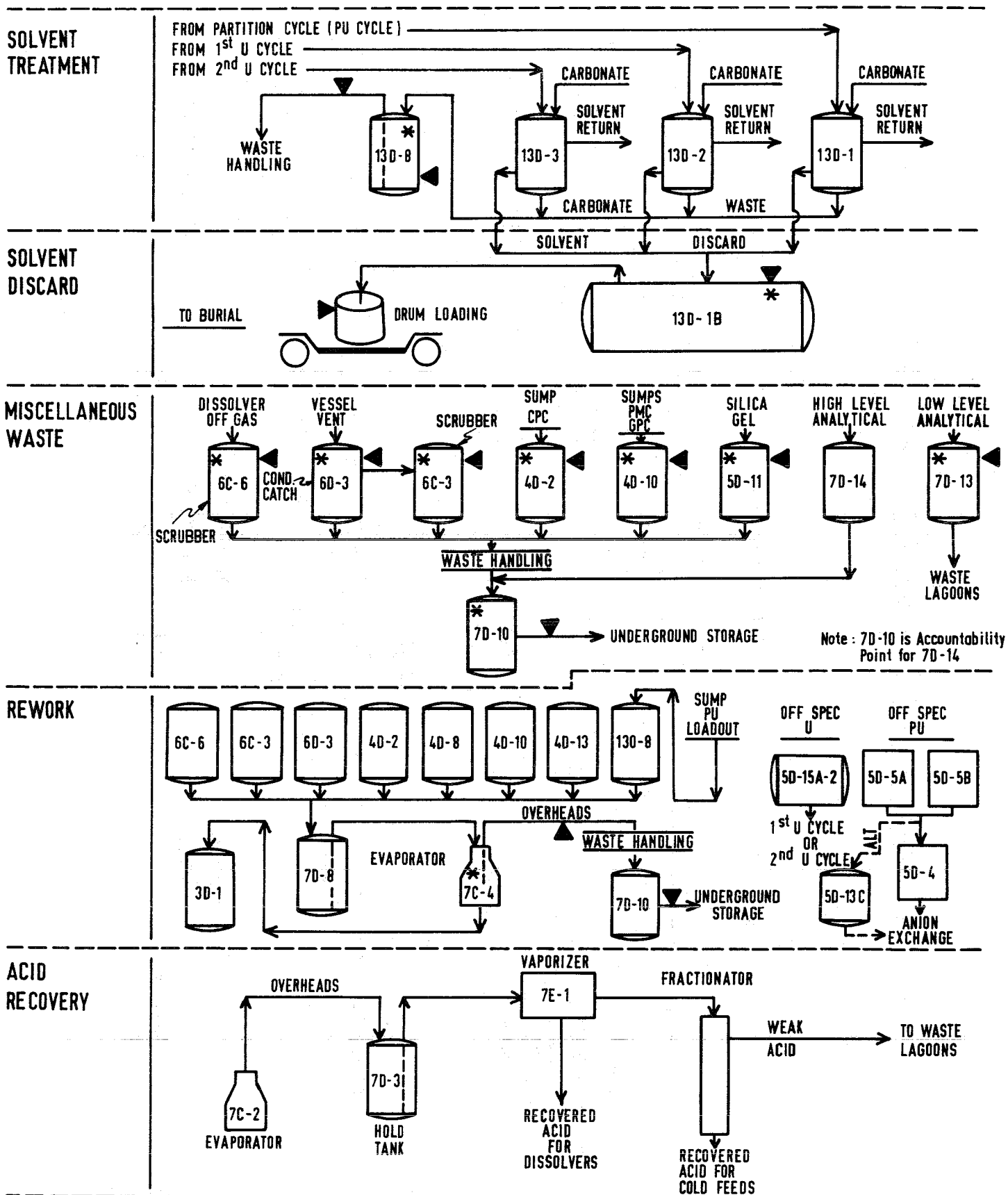

ACCOUNTABILITY POINTS *

SAFEGUARD CONTROL POINTS ▼

Fig.2.3 FLOWSHEET OF PU-MAINFLOW THROUGH THE NFS - PLANT

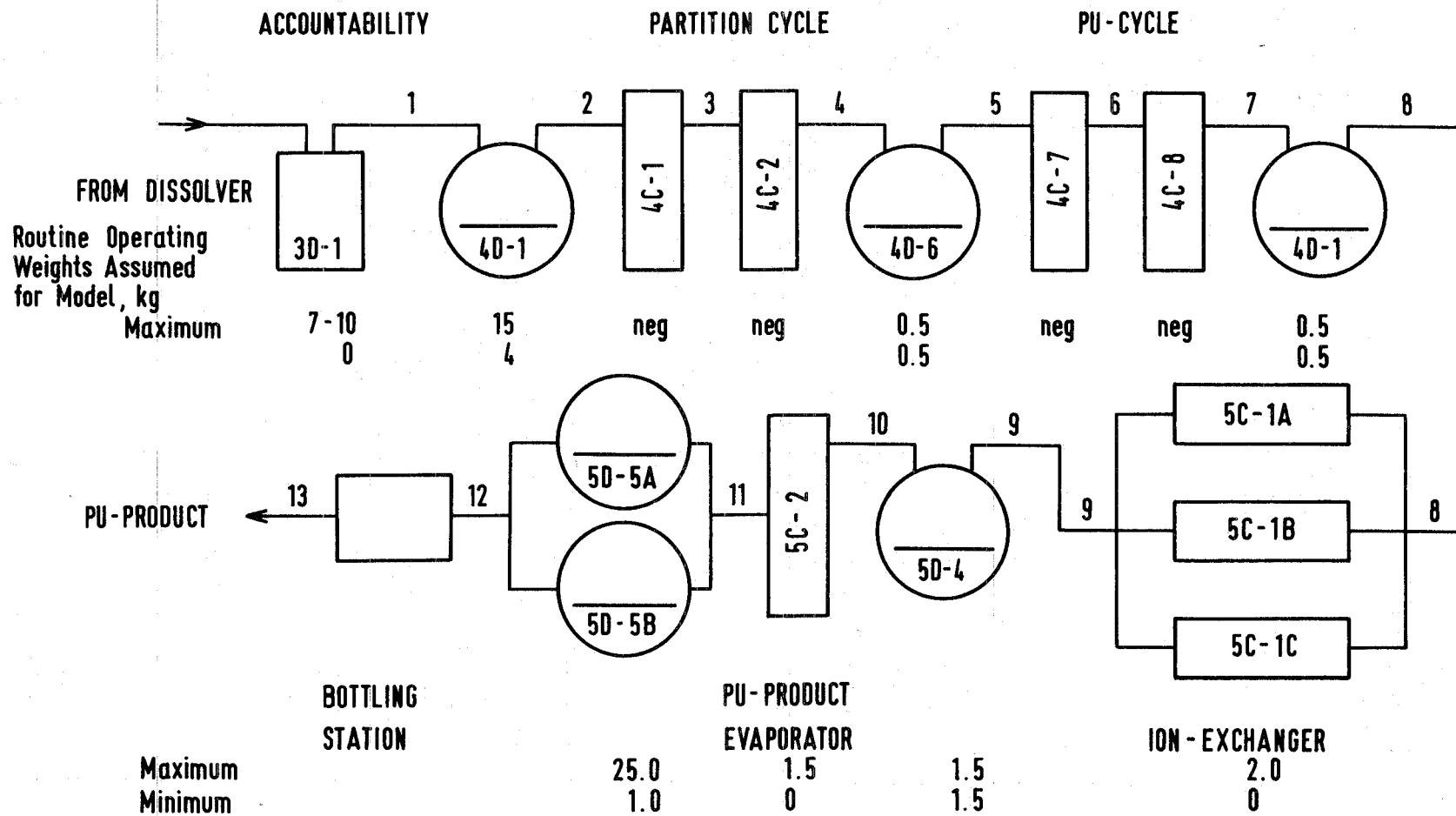

2. Data of the ALKEM Fabrication Plant

2.1 Description of the plant

2.1.1 Purpose and type of the plant

The plant will produce fuel pins for thermal and fast breeder reactors. The pins for the thermal reactors will contain 0.5 - 4% Plutonium, those for the fast breeder 10 - 16% Plutonium /1/. It consists of an automatic line, which will be set to work at the end of 1973.

At that time, the so called hand line, which is working in the moment, will be liquidated. Therefore we only take the automatic line into consideration.

2.1.2 Capacity of the plant

The capacity of the Alkem depends on the Pu-concentration. These data are given in the following table:

	capacity kg / d		
Pu - concentration %	fuel	Pu	number of pins per day
2,5	200	5,3	100
15,8	50	7,9	

The number of produced pins will be around 100 per day.

The storage area will take up to 500 kg of fuel.

/1/ Drosselmeyer, E., Gupta, D., Hagen, A., Kurz, P.
"Development of Safeguards Procedures and Simulation of Fissile Material Flow for an ALKEM Type Plant Fabricating Plutonium Fuel Elements for Fast Breeder Reactors."
KFK 1110 (1971)

2.1.3 Layout of the plant

The complete production equipment is installed in one large hall, in which the different working areas, namely

Conversion
Powder production
Pin production
Quality control
Analysis
Scrap recovery

are subdivided by so called caissons. The sketch of a layout of the plant is given in Fig. 2.4, which also contains the main routes followed by nuclear material.

2.2 Flow, handling and location of nuclear material

2.2.1 Pu - storage area

At the storage area the following items are stored:

- a) PuO_2 - powder in 2.0 kg containers from the arrival at the facility up to processing
- b) PuO_2 - powder in 2.5 kg containers, produced in the conversion area and waiting for further processing.
- c) Pu - nitrate in 8 l polyethylene bottles (that is corresponding to 2.0 kg Pu), which are protected by stainless-steel tubes, imbedded in concrete.

2.2.2 Conversion

Half of the incoming plutonium will be Pu-nitrate solution; with a Pu content of 10 - 20 %. The capacity of this area is comparatively small, that means that it mainly will produce for the storage and will start ca. 14 days in advance.

The bottles are emptied into the 800 l homogenization tank (5 bottles a 8l per day). The solution is converted to Pu-oxide in batches of about 40 l (oxalate precipitation, filtration, calcination). The powder will be transported in 2.5 kg containers and stored in the storage area, 3 - 5 % of the fissile material are waste.

2.2.3 Powder Preparation

Coming from the storage area, the Pu powder is calcined in batches of 25 kg at 700° - 1.000° C. Then it is screened, homogenized in portions of 50 kg. The powder is mixed with sinterable UO_2 powder and the recycle scrap and homogenized in portions of 120 kg, which corresponds to an accumulation of about one week.

The pellets are pressed and dried with a density of $4.8 - 5.8 \text{ g/cm}^3$ and a Pu content of 2.5 - 16 %.

4 - 8 % of the feed are expected to be waste.

2.2.4 Pellet Production

The sintering of the pellets takes 24 hours and needs 1700°C , the density of the pellets goes to $9.2 - 10.6 \text{ g/cm}^3$. Grinding and measurement of dimensions and surface of the pellets complete this production step. They are analysed on a random base and counted.

2 - 4 % are expected to be waste during the sintering step and

2 - 4 % during the grinding step.

2.2.5 Pin production

The pellets are put together to partial columns of a length of 400 mm, and a weight of 320 g; these are measured and identified. Then they are introduced into the cladding tubes. After decontamination the open end is closed by welding in an atmosphere of helium.

The expected scrap of 2 - 4 % is generated by pins which do not meet the specifications, concerning mainly geometry, contamination as well as welding quality.

2.2.6 Quality control

The tests are : pressure test, leak test and x - ray test. Contamination and total geometry are measured. 3 - 5 % are expected to be scrap. There is no possibility to determine the Pu-content of the fuel pins.

2.2.7 Pin storage

The finally tested and measured fuel pins are stored at the pin storage area until shipping.

2.2.8 Analysis

At the analysis area the samples coming from different areas are analysed by different methods: Potentiometry, coulometry x-ray fluorescence, mass spectrometry and weighing. The accumulated samples are filled after analysis into a 8 l bottle and transferred to the waste storage.

2.2.9 Scrap recovery

Dry scrap consists of rejected pellets, partial piles.

It is grinded and recycled at the powder preparation. Wet scrap, that means concentrated Pu-nitrate solution is converted in the conversion area to Pu-Oxide.

2.2.10 Waste Storage

The wastes from different areas divide into wet and dry waste. The dry one is gathered in 200 l -barrels, containing 2 g Plutonium or up to 20 g Plutonium per barrel. The liquid wastes come in 8 l-bottles from analysis area with a maximal content of 24 g Pu per bottle and from the conversion area with maximal 72 g Plutonium.

2.3 Flow measurements

2.3.1 Input of Pu

The incoming Pu comes in the form of Pu-Oxyde and Pu-Nitrate. The input-measurements are done at the shippers facility, so that only counting, identification and seal control have to be done at the Alkem. These data tell the Inspector, how much Pu has entered the facility.

2.3.2 Conversion Area

Half of the incoming Pu will be Pu-Nitrate. When a physical inventory is done, the amount of solution in the 800 l homogenisation tank has to be determined, but there is no direct method to do that. Therefore input and output of the conversion area have to be controlled by the inspector.

The 8 l-bottles are emptied into the tank, the inspector watches that and the breaking of the seals. A sealed dose-pump tells him the amount of Pu-nitrate-solution which has been taken out of the tank. Thus he knows the amount of solution, which is in the tank. With that data and a drawn sample he can determine the amount of Pu in the homogenisation tank.

2.3.3 Measurements in the Production Area

The data, which are gathered here, give the output data of the plant. The sintered and grinded pellets are counted and their Pu content is determined on a random base.

The inspector takes samples of the pellets and counts the number of produced pellets per day (reads and controls a counting machine).

The weight and number of the partial piles filled into a hull determine the amount of Pu in a certain fuel pin, which itself is identified through a number.

2.3.4 Waste measurements

Dry waste will be gathered in a 200 l-barrel. It will be full after approximately one production day, then it is closed and sealed and the Pu-content measured. Once a month the waste-barrels are shipped.

The 8 l-bottles with liquid waste are coming from the analysis area (appr. 24 g Pu/bottle) and from the conversion area (appr. 72 g Pu/bottle). The inspector draws a sample from every bottle and then seals the bottles.

2.3.5 Flow measurement data

Batch data, measurement accuracies and effort per single measurement are listed in Table 2.6.

2.4 Inventory Taking

2.4.1 The principle of inventory taking at the Alkem

The difficulty in inventory taking at the Alkem is, that the plant will never be empty or have a total shut-down. In principle one is to take physical inventory, when the least amount of Pu is in the fabrication line and most of it in the storage areas.

Therefore the inventory should be taken at the end of a campaign. But at that time, the conversion area will have been started to produce for the next campaign and the cladding area will be busy with re-cladding damaged fuel pins.

2.4.2 Pu-storage area

Weight and Pu-content of the received Plutonium containers are determined at the shipper's facility. Thus inventory taking is reduced to identification, counting and seal control.

2.4.3 Conversion Area

The conversion area should be empty apart from the 800 l homogenisation tank.

The volume of the solution in the tank is determined through the difference at volumes put into and taken out of the tank. A drawn sample at the time of inventory taking then determines the amount of Pu inside the tank.

The rest of the conversion area is empty apart from the 2 l containers with approximately 2 kg PuO₂, which are in the storage.

They have to be counted, weighed and their Pu-content is determined through n-coincidence.

2.4.4 Powder preparation, pellet and pin-production

During an inventory at the end of a campaign the hull and cladding will still be in operation. The inspector has to ensure that no material is brought in or out of that part. (They are put under containment.)

Powder preparation and pellet production have to be empty; scraps from these areas are gathered in 2 l-containers and Pu-content determined.

When cladding is completed (normally some days after the end of an inventory taking in the other areas) the inventory of Pu in this areas is determined.

2.4.5 Pin storage

The pins in the storage are counted and identified and their Pu-content is determined through a rough γ -scanning. This will be done on a random sampling base during the flow-measurements.

2.4.6 Waste storage

The measurements in the waste storage should have be done during the flow-verification. Therefore it will be sufficient to count and identify the units in the storage.

2.4.7 Scrap recovery area

Wet and dry scrap are gathered here and their Pu-content is determined.

2.4.8 Analysis area

The samples in the analysis area are gathered in 2 l-bottles and their Pu content is measured through n-coincidence.

2.4.9 Data for inventory taking

The data for inventory taking are listed in table 2.7.

Table 2.5

Throughput Data

Pu-throughput/year	[tons]	1.1 - 1.6
Liquid Waste	[% of input]	0.1 %
Dry Waste	[% of input]	0.4 %
Number of campaigns/year		1 - 10
Number of working days/year		200

stream	status	recipient or bulk size	number of items per year	amount of Pu per item	control point	measuring method	effort/measurement manhour	standard deviation per measurement	
								rand(%)	syst(%)
Input	Pu-Oxide	2kg-container	350	2 kg	shipper	weighing (gross, tara) Coulometric	1 min	0.2 0.3	0.2 0.4
	Pu-Nitrate	8l- bottle	350	2 kg	(output)	weighing sampling conc.det.	1 min	0.2 1.0 0.5	0.2 - 1.0
Product	sintered Pu/U mixed oxide	fuel-pins or partial piles or pellets	~ 20,000 or	~ 70 g	-	-	reading of the on-line computer	-	-
			~ 80,000 or ~ 6,400,000	~ 17,5g ~ 0.22g	production line laboratorium (random base)	weighing Coulometric		0.2 0.3	0.2 0.4
Waste	dry waste	200l-barrel	50	20 g	waste	n-coincidence and γ-spectro- scopy	1 h	50	50
			150	2 g	storage area				
	liquid waste	8l-bottle	60	24 g	analysis area	weighing	1 h (weighing)	5.0	-
			50	72 g	conversion area	sampling conc.det.	2 h (sampling)	10 5	20 10

Table 2.6: Throughput data of the ALKEM fabrication plant for Pu

Place of Inventory	Unit	Activity	Average number of units	Pu-content per unit	δ_r δ_s [%]	Net-effort/unit	Remarks
Pu-storage (input)	2 kg PuO ₂ -container	seal control	120	2 kg	- -	2 min	Weight and Pu-content are determined at the shipper's facility stored: need for 1 campaign
	8 l PuN-bottle	counting identification	120	2 kg	- -	2 min	
Pin-storage (output)	Fuel-pin	identification γ -scanning	1,000	70 g	3.0 2.0	10 min	Data for fuel pins are given through flow-measurements, γ -scanning shows rough Pu-content of the pins.
Waste-storage	8 l-bottle barrel	seal control	100		- -	2 min	The sealing of barrels and 8 l-bottles is done during the flow-measurements.
		identification	15		- -	2 min	
Pu-storage (PUO ₂ from conversion area)	2 l-container with 2 kg PuO ₂	counting weighing	50	1,75 kg	0,2 - 3.0 2.0	30 min 30 min	Rest of conversion should be empty. Pu-content: n-coincidence
Conversion area	800 l-homogenisation tank	volume determination sampling concentr.determ.	1	20 kg	0.5 - 1.0 - 0.5 1.0	2 h	Volume determination is given through the difference between input and output. The error is mainly the error of output-determination.
Scrap recovery area	1 l-container (7 kg mixed oxide) with dry scrap	weighing Pu-content	50	0.5 kg	0.2 -	1,5 h(sampl.) 2,5 h(analys.)	Weighing: gross,
		potentiometry			0.3 0.4		
	2 l-bottle with liquid scrap	weighing sampling conc.determ.	20	0,25 kg	0,2 - 1.0 - 0.5 1.0	1 h(weighing) 2 h(sampling)	

Table 2.7: Data for Inventory Taking at the ALKEM at the End of a Campaign

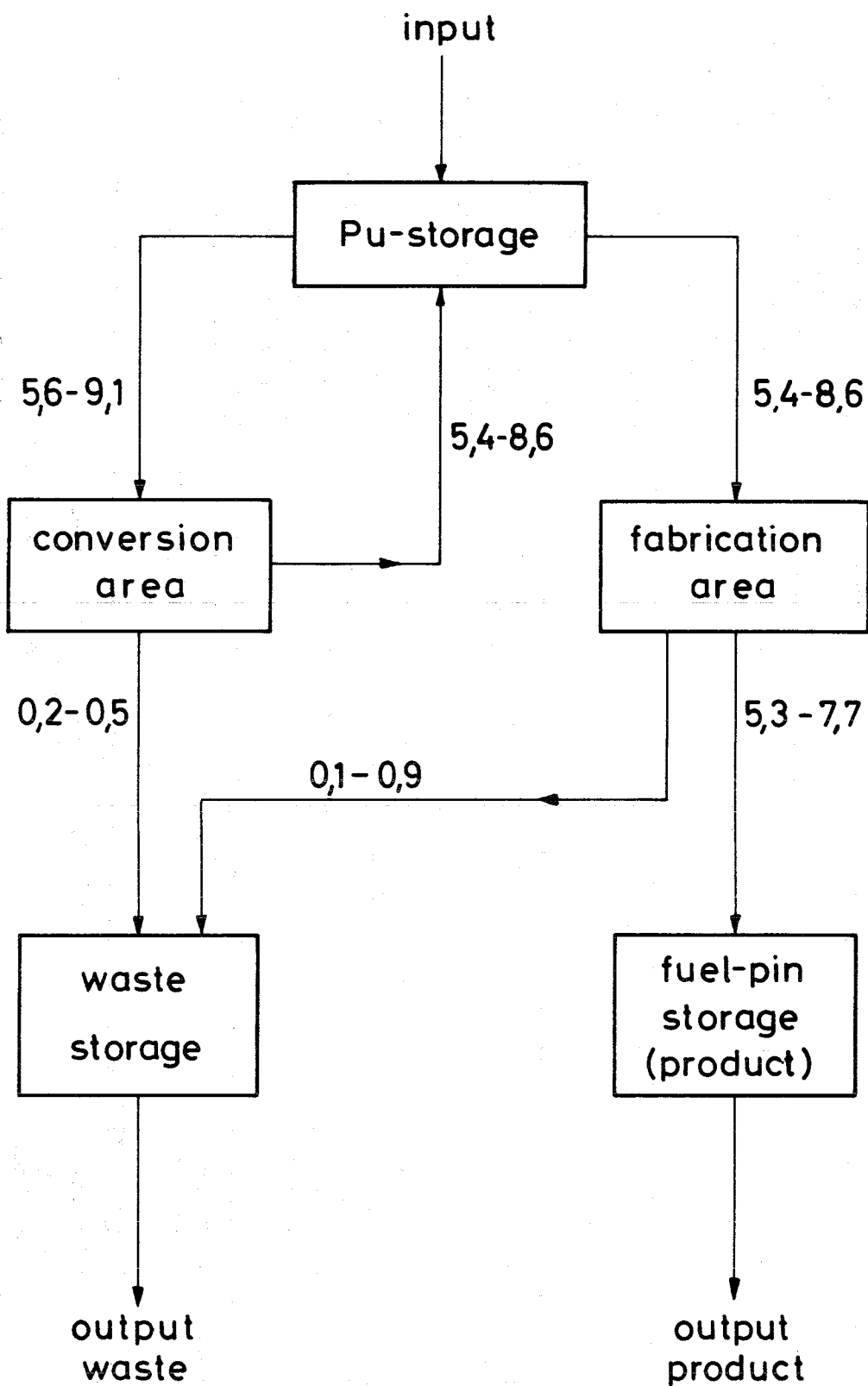

Fig. 2.4

Flow - diagram of Pu in the Alkem (kg Pu/day)

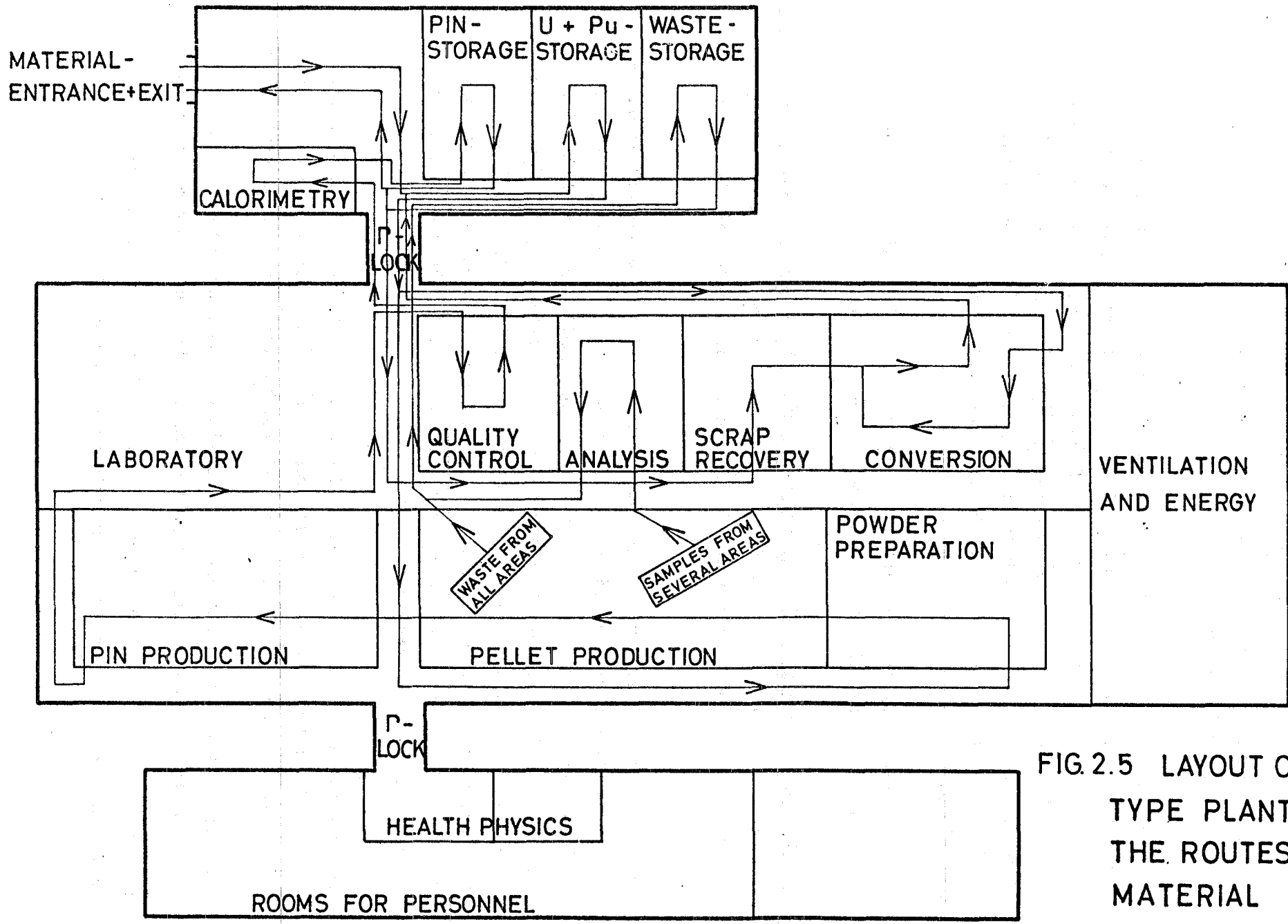

FIG. 2.5 LAYOUT OF AN ALKEM TYPE PLANT INDICATING THE ROUTES OF NUCLEAR MATERIAL

Chapter III Optimal Allocation of Safeguards Effort and Parameter Studies

3.1 Introduction

In this chapter the theoretically derived formulae of chapter I shall be applied to the data of the reference plants in chapter II. The reference interval of time is one year. It will be assumed that two inventories/a will be taken.

If an operator wants to divert material he has two possibilities of doing so. He can report the unfalsified content of the batches to the inspector but has diverted material beforehand and hopes to conceal this through the uncertainty of the material balance. The theoretical basis for that question is found in chapter I, part 2, "Verification of the material balance". There the solution to the following problems is also given:

- a) the optimal way in which the operator will distribute the diverted amount M between the two inventory periods and
- b) the optimal way in which the inspector will choose the probabilities α_1 and α_2 of a false alarm for the first and second inventory period, if he has a fixed overall probability of a false alarm for the whole year.

The next diversion strategy of the operator is to remove a certain amount μ of material from different batches. This amount will not be so great that the inspector can detect it through a variable sampling scheme which gives a high probability of detection for quite a small sampling plan. Therefore the amount μ_i diverted from certain batches in the i -th class will be in the range of the systematic error or the batch-to-batch variation. In this paper we choose the μ_i in formula 3-15a to be equal to the square root of the variance of the systematic error.

The question now arises as to how to distribute a given budget in an optimal way. We are going to employ two different statistical methods; we call them D_1 -statistics (cf Chapter I 3.1 and 3.2) and D_2 -statistics (cf Chapter I 3.3).

After the sampling plan has been evaluated and inspector and operator have done their measurements a significance test has to be performed again.

Fig. 3.0 gives a flow-diagram of the significance tests which have to be performed during the course of the reference interval of time.

2. Application on NFS

2.1 Variance of the Plutonium Measurements

2.1.1 Inventory Taking

Every 6 months a physical inventory shall be taken. It is performed through a flush-out with an amount of 1 kg Plutonium and an accuracy of ± 1 kg Plutonium. In the following, the inventory taking is assumed to be a normally distributed random variable with expectation value 1 and variance 0.333 (i.e. the variance of a random variable which is equally distributed in the interval $[0,2]$).

2.1.2 Variance of Plutonium Measurements for Flow-Verification

The data we use are found in the tables 2.2 and 2.3 of Chapter II: "Data of the NFS Reprocessing Plant". The reference interval of time is 6 months, which corresponds to 5 campaigns. Therefore, we have 125 input batches, 380 product batches and 450 waste batches. The formulae used to compute the variances for the input, product and waste measurements are well known and written down without further discussion.

Input

The input is measured in the input accountability tank. The volume is determined through a dip-tube system, the concentration through sampling and X-ray fluorescence. We use the following formula:

$$\text{var}(\text{Pu}_{\text{Input}}) = N^2 \cdot g^2 \cdot (\delta_{s,x}^2 + \delta_{s,v}^2) + N \cdot g^2 \cdot (\delta_{r,x}^2 + \delta_{r,v}^2 + \delta_p^2)$$

with

N	=	125	(number of input batches in half a year)
g	=	7.0 kg	(amount of Plutonium per batch)
$\delta_{r,x}$	=	0.006 kg	(Rel. Standard Deviation (RSD) for random error (r) of concentration determination (x))
$\delta_{s,x}$	=	0.003 kg	(RSD for systematic error (s) of conc. det.)
$\delta_{r,v}$	=	0.0035 kg	(RSD for random error of volume det.)
$\delta_{s,v}$	=	0.001 kg	(RSD for systematic error of volume det.)
δ_p	=	0.01 kg	(RSD for sampling)

With these data we get:

$$\text{var}(\text{Pu}_{\text{Input}}) = 8.6 \text{ kg}^2 \quad (\delta = 0.0034)$$

Product

The product measurements are done through weighing, sampling and concentration determination. The data for the relative standard deviations are found in Table 2.3 in "NFS-Data".

We take the following formula:

$$\text{var}(\text{Pu}_{\text{Product}}) = N^2 \cdot g^2 \delta_{s,x}^2 + N \cdot g^2 \cdot \delta_{r,x}^2 + 2 \cdot N \cdot g^2 \cdot \delta_{r,g}^2 + N \cdot g^2 \delta_p^2$$

(The factor 2 in the formula comes from gross-tare weighing.)

The data are found in Table 2.2 and 2.3 of Chapter II. We calculate the variance to

$$\text{var}(\text{Pu}_{\text{Product}}) = 6.97 \text{ kg}^2 \quad (\delta = 0.003)$$

Liquid Waste

The amount of Plutonium leaving the plant as waste is measured through volume determination (level indicator) and concentration determination (TTA extraction α -counting).

The formula to be used is the following one

$$\begin{aligned} \text{var}(\text{Pu}_{\text{Waste}}) &= N^2 \cdot g^2 \cdot \delta_{s,x}^2 + N \cdot g^2 \cdot \delta_{r,x}^2 + \\ &+ N \cdot g^2 \cdot \delta_{r,v}^2 + N^2 \cdot g^2 \cdot \delta_{r,s}^2 + N \cdot g^2 \cdot \delta_p^2 \end{aligned}$$

With the data of Table 2.2 and 2.3 of Chapter II we calculate

$$\text{var}(\text{Pu}_{\text{Waste}}) = 0.78 \text{ kg}^2 \quad (\delta = 0.1)$$

Overall Variance of Pu-Measurements in Flow-Verification

The variance of the flow-measurements is the sum of the variances for input, product and waste measurements.

$$\text{Thus var}(D) = 16.35 \text{ kg}^2$$

and

$$\begin{aligned}\text{var}(MUF_1) &= \text{var}(I_0 + D - I_1) = \text{var}(I_0) + \text{var}(D) + \text{var}(I_1) \\ &= 0.333 + 16.35 + 0.333 \\ &= 17.02 \text{ kg}^2\end{aligned}$$

3. Variance of Uranium Measurements in Flow Verification

In this part we just write down the calculated values for the variances. The used formulae are the same as before, the data are found in Chapter II, Tables 2.2 and 2.4.

$$\text{var}(U_{\text{Input}}) = 146,893 \text{ kg}^2$$

$$\text{var}(U_{\text{Product}}) = 81,616 \text{ kg}^2$$

$$\text{var}(U_{\text{Waste}}) = 3,724 \text{ kg}^2$$

$$\text{var}(D) = \text{var}(U_{\text{Input}}) + \text{var}(U_{\text{Product}}) + \text{var}(U_{\text{Waste}})$$

$$\text{var } D = 232,233 \text{ kg}^2$$

2.2 Verification of the Material Balance

After an inventory period the operator has reported a set of measurement data. The inspector closes the material balance with these data and calculates MUF_1 which is defined in chapter II, 2.1. Now he performs a significance test, using the following formulae (of chapter II, 2.1)

$$i) \quad \sigma_1^2 = \sigma_{I_0}^2 + \sigma_{D_1}^2 + \sigma_{I_1}^2$$

$$ii) \quad s_1 = \sigma_1 \cdot U(1-\alpha_1)$$

$$iii) \quad 1-\beta_1 = \phi\left(\frac{M_1}{\sigma_1} - U_{1-\alpha_1}\right)$$

In the case of the NFS the physical inventories are small ($I = 1 \text{ kg} + 1 \text{ kg}$ Plutonium) therefore the variance σ_I^2 can be neglected, i.e. σ_1^2 is mainly the variance of the throughput measurements ($\sigma_1^2 = 17.02 \text{ kg}^2$). With the help of formula (ii) the inspector evaluates the significance threshold for his chosen probability α of a false alarm. In Fig. 3.1 one finds s_1 as a function of α (with $\sigma_1^2 = 17.02 \text{ kg}^2$).

Two possibilities arise:

$$H_0: MUF_1 \leq S_1 \quad \text{or} \quad H_1: MUF_2 > S_1$$

In the case of H_0 the inspector states that the material balance is correct.

In the case of H_1 he states: "Material has been diverted". (The activities which will start now cannot be treated in this paper being of a political nature. A possible first solution would be to remeasure all the available batches and to establish a new material balance with a smaller MUF.)

It has to be made clear at this point that the inspector has not the possibility of determining the amount M of diverted material. He can only make a statement in the following form:

Let α_1 be the probability of a false alarm, chosen by the inspector. (In α_1 % of the cases he will make the wrong statement: "diversion".) Then he knows: If the operator has diverted M kg Plutonium, in $1-\beta$ % of these cases MUF_1 will be greater than s_1 , and a diversion will be stated.

The probability of detection $1-\beta$ as a function of the diverted amount M_1 in the case of one inventory period is shown in Fig. 3.2, the parameter is the probability α_1 of a false alarm (formula iii)). We now come to the second inventory period. MUF_2 is calculated and a significance test is performed using the following formulae (cf ch. I , 2.2)

$$(i') \quad \sigma_1^2 = \sigma_{I_0}^2 + \sigma_{D_1}^2 + \sigma_{I_1}^2$$

$$\sigma_2^2 = \sigma_s^2 + \sigma_{D_2}^2 + \sigma_{I_2}^2$$

$$(ii') \quad 1-\alpha = (1-\alpha_1) \cdot (1-\alpha_2)$$

$$(iii') \quad s_2 = \sigma_2 \cdot U(1-\alpha_2)$$

$$(iv') \quad \beta = \phi\left(U_{1-\alpha_1} - \frac{M_1}{\sigma_1}\right) \cdot \phi\left(U_{1-\alpha_2} - \frac{a \cdot M_1 + M_2}{\sigma_2}\right)$$

In the case of a NFS type plant the inventory is small and the variance of Plutonium inventory measurements is assumed to be zero. Furthermore the throughput D is assumed to be the same for every inventory period. Therefore $\sigma_1^2 = \sigma_2^2$ and the significance threshold $s_2 = s_1$.

Now the problem of choosing α_1 and α_2 in an optimal way to get a fixed overall probability α for the whole year arises. In the case of the NFS type plant the evaluation shows the optimal choice to be $\alpha_1 = \alpha_2$; the optimal choice of the operator to distribute the amount M to be diverted in the course of the two inventory periods is $M_1 = M_2$ (cf ch. I , 2.2.3). The statement of the inspector will be in the following form:

Let α be the overall probability of a false alarm for the two inventory periods. If the operator has diverted M kg Plutonium in an optimal way (choosing $M_1 = M_2$ to minimize the probability $1-\beta$ of a detection) in $1-\beta$ % of these cases MUF_1 will be greater than s_1 or MUF_2 will be greater than s_2 . That means at least one diversion will be detected with the probability $1-\beta$. The inspector will choose $\alpha_1 = \alpha_2$ under the constraint (ii').

The probability of detection $1-\beta$ as a function of the diverted amount M of Plutonium in the case of two inventory periods is shown in Fig.3.3, the parameter is the overall probability α of a false alarm (formula iv'))

With the help of formula (ii') written in the following form:

$$(ii'') \quad \alpha_{1/2} = 1 - \sqrt{1-\alpha}$$

the inspector can evaluate for a fixed overall probability α of a false alarm the probabilities α_1 and α_2 . Then he finds the significance thresholds s_1 and s_2 in Fig.3.1 and can perform his significance test.

2.3 Verification of Data

In the case of the NFS it is possible to verify the data with the help of two different statistical methods. The first is the so-called D_1 -statistic (chapter I, 3.2) the second is the D_2 -statistic (chapter I,3.3).

What is the difference between the two methods? At the NFS an inspector watches the volume determinations and the taking of samples. That means that the volume determination and sampling are correct, data could only be falsified by the operator in reporting a wrong Plutonium concentration to the inspector, who on a random base will verify the Plutonium concentrations of his samples. Therefore, in the case of D_1 -statistics a reduction of total effort will be reduction of cost for analysis (not every sample taken by the inspector will be analysed).

If one wants to reduce inspection effort in the plant itself, one has to employ D_2 -statistics. That means not every batch in the course of an inventory period will be supervised by the inspector. Since those batches controlled by the inspector are a priori known to the operator they will not be falsified. But from the knowledge of the batch-to-batch variation the inspector can estimate the true content of the uncontrolled batches.

Verification of Data with the help of D_1 -statistics

The data used can be found in Table 3.1.

Tab.3.2 shows the optimal sample size for a given effort, in the sixth row the probability of detection for a fixed amount of diverted material is given. Fig.3.4 shows the probability of detection as a function of the diverted amount M with effort as parameter.

One can see that there is only a weak influence of the total effort upon the probability of detection. The reason for that is the relatively small standard deviation of the measurements. Therefore, it is reasonable for the inspector to take only 20 % of the effort for full coverage.

Verification of Data with the help of D_2 -statistics

The data used can be found in Table 3.3.

They are different from those in Tab.3.1. The effort is now spent in man-hours and not in costs for analyses of a sample. Furthermore the standard deviations are needed only for the inspector's measurements (D_1 -statistics: sum of variances for inspector's and for operator's measurements).

Tab.3.4 shows the optimal sample size for a given effort, in the seventh row one can find the probability of detection for a fixed diverted amount of Plutonium.

In Fig. 3.5 one finds the probability of detection as a function of the diverted amount μ with the effort as parameter.

3. Application on the Alkem Type Plant

3.1 Variance of the Plutonium Measurements

3.1.1 Inventory Taking

Every 6 months a physical inventory shall be taken. The inventory taking in input, product and waste storage is done through seal-control, identification and counting. In the pin storage the fuel pins are measured on a random base through γ -scanning. It is done during the flow-measurements and shall provide the inspector with additional information. Therefore this measurement does not belong to the flow nor to the inventory measurements.

In 50 % of the campaigns the input will be Plutonium Nitrate Solution which has to be converted to Plutonium Oxide. The conversion has a smaller throughput than the production area and has to start a fortnight in advance. For inventory taking purposes the inventory in the plant should be as small as possible therefore, the inspector should choose the time for inventory taking such that in the following campaign no nitrate will be converted.

The inventory taking reduces to the scrap recovery area with dry and liquid scrap. The data used can be found in Table 2.7.

Dry Scrap

The containers are weighed (gross and tare, the tare weighing has to be done by the inspector during the flow measurement activities and has not to be repeated here). Then a sample is taken and the Pu-concentration is determined through Potentiometry. We use the following formula:

$$\text{var}(\text{Pu}) = 2 \cdot N \cdot g^2 \cdot \sigma_{r,g}^2 + N \cdot g^2 \cdot \sigma_{r,x}^2 + N^2 \cdot g^2 \cdot \sigma_{s,x}^2$$

with

N = number of containers with dry scrap
g = amount of Plutonium per container
r = random
g = weighing

s = systematic
x = concentration determination

Thus we get

$$\text{var(Pu)} = 0.010 \text{ kg}^2 \quad (\delta = 0.004)$$

Liquid Scrap

The bottles with liquid scrap are weighed (gross and tara, tara weighing done beforehand), from each bottle a sample is drawn and analysed. We use the following formula:

$$\text{var(Pu)} = N \cdot g^2 (2 \cdot \delta_{r,g}^2 + \delta_p^2 + \delta_{r,x}^2) + N^2 \cdot g^2 \cdot \delta_{s,x}^2$$

where δ_p means the relative standard deviation for the sampling. Thus we get:

$$\text{var(Pu)} = 0.003 \text{ kg}^2 \quad (\delta = 0.01)$$

Overall Variance of Pu-Measurements in Inventory Taking

The variance of the inventory taking measurements is the sum of the variances for dry and liquid waste.

$$\text{var (I)} = 0.013 \text{ kg}^2$$

3.1.2 Variance of Plutonium Measurements for Flow-Verification

The data used are found in Table 2.5 of Chapter II: "Throughput Data of the Alkem for Plutonium". The reference interval of time is 6 months.

Input Plutonium-Oxide

Every container is weighed (gross, tara) and the Pu-content is determined through coulometric. We use the following formula:

$$\text{var(Pu)} = N \cdot g^2 \cdot \delta_{r,g}^2 + N \cdot g^2 \delta_{r,c}^2 + N^2 g^2 \delta_{s,c}^2 + N^2 \cdot g^2 \cdot \delta_{s,g}^2$$

- N = 175 (number of items in half a year)
 g = 2 kg (amount of Pu per item = container)
 $\delta_{r,g}$ = rel. standard deviation (RSD) for random (r) error of weighing (gross-tara-weighing gives a factor 2)

Due to the gross-tara-weighing there is no systematic error.

- $\delta_{r,c}$ = RSD of random error for concentration determination (c)
 $\delta_{s,c}$ = RSD of systematic (s) error for concentration determination.

With the data for δ in Table 2.7 and the above formula we get for the variance

$$\text{var(Pu)} = 2.46 \text{ kg}^2 \quad (\delta = 0.004)$$

Input Plutonium-Nitrate

The items are Pu-Nitrate bottles. For every 10 bottles one sample is drawn and the Plutonium-concentration of the solution is determined. The amount of solution is determined by gross tara weighing. We take the following formula:

$$\text{var(Pu)} = N \cdot g^2 \cdot (\delta_{r,c}^2 + \delta_{r,g}^2 + 10 \cdot \delta_p^2) + N^2 \cdot g^2 (\delta_{s,g}^2 + \delta_{s,x}^2)$$

- N = 175, g = 2 kg
 δ_p = RSD for sampling

Resulting variance:

$$\text{var(Pu)} = 13.46 \quad (\delta = 0.01)$$

Product

The amount of Pu leaving the Alkem is determined through counting and weighing of the partial columns and through measuring the Pu-concentration of the pellets on a random basis. Every 2 days the inspector takes a pellet as sample. Let $x_k^{(i)}$ be the Pu-concentration of the i-th sample in the k-th campaign ($k = 1, 2, 3, 4, 5$), let n_k be the number of partial piles per campaign.

The average Pu-concentration \bar{x}_k is:

$$\bar{x}_k = \sum_{i=1}^{10} \frac{x_k^{(i)}}{10}$$

(We take 5 campaigns à 20 working days each; that means n_k is the same for every campaign.)

We get for the output of Plutonium in product:

$$(Pu_{out}) = \sum_{k=1}^5 \sum_{i=1}^{n_k} G_k^{(i)} \cdot \bar{x}_k$$

$G_k^{(i)}$ = weight of the i-th partial column in the k-th campaign.

We assume that $G_k^{(i)}$, $x_k^{(i)}$, n_k are the same for every i and k.

The variance is given through the following formula:

$$\text{var}(Pu_{out}) = \sum_{k=1}^5 n_k^2 \text{var } G_k \cdot \bar{x}_k$$

$$\text{var}(Pu) = 5^2 \cdot n^2 \cdot G^2 \sigma_{s,\bar{x}}^2 + 5^2 n^2 \bar{x}^2 \sigma_{s,g}^2 + n^2 G^2 \cdot 5 \cdot \sigma_{r,\bar{x}}^2 + 5n \bar{x}^2 \sigma_{r,g}^2$$

$g = G \cdot \bar{x}$ is the Pu-content per partial column

σ = the standard deviation (SD) for systematic (s) and random (r) error of concentration determination (x) and weighing (g) respectively.

The RSD δ is determined through

$$\delta_g = \frac{\sigma_g}{G}, \quad \delta_x = \frac{\sigma_x}{x}$$

Thus we get for the variance:

$$\text{var(Pu)} = 5^2 \cdot n^2 \cdot g^2 \delta_{s,\bar{x}}^2 + 5^2 \cdot n^2 \cdot g^2 \delta_{s,g}^2 + 5 \cdot n^2 \cdot g^2 \delta_{r,\bar{x}}^2 + 5 \cdot n \cdot g^2 \delta_{r,g}^2$$

$\delta_{s,\bar{x}}$ is given through the calibration error of the laboratory where the analysis is done and is the same for every campaign, whereas $\delta_{r,\bar{x}}^2 = \frac{1}{10} \delta_{r,x}^2$ depends on the sampling plan. We write the formula in the following form:

$$\text{var(Pu)} = 5 \cdot n \cdot g^2 (5 \cdot n \delta_{s,x}^2 + 5 \cdot n \cdot \delta_{s,g}^2 + \frac{n}{10} \delta_{r,x}^2 + \delta_{r,g}^2)$$

We take $g = 17.5 \cdot 10^{-3}$ kg and $n = 10.000$ and get

$$\text{var(Pu}_{\text{out}}) = 15.45 \text{ kg}^2 \quad (\delta = 0.005).$$

Dry Waste

The dry waste comes in 200 l-barrels into the waste storage area and is measured through n-coincidence and γ -spectroscopy. During half a year there will be 25 barrels with 20 g Plutonium and 75 barrels with 2 g Plutonium. We use the following formula:

$$\text{var(dry waste)} = 25 \cdot g_1^2 \cdot \delta_r^2 + 75 \cdot g_2^2 \cdot \delta_r^2 + 25^2 \cdot g_1^2 \cdot \delta_s^2 + 75^2 \cdot g_2^2 \cdot \delta_s^2$$

with $g_1 = 0.02$ kg and $g_2 = 0.002$ kg. Thus we get

$$\text{var(dry waste)} = 0.0707 \text{ kg}^2 \quad (\delta = 0.409).$$

Liquid Waste

Liquid waste comes from the analysis area (30 bottles with 0.024 kg Plutonium in half a year) and from the conversion area (25 bottles with 0.072 kg Plutonium). The 8 l-bottles are weighed gross and tara, they are sampled and their Plutonium concentration is determined. We use the following formula:

$$\begin{aligned} \text{var(Liquid Waste)} &= 30 \cdot g_1^2 \cdot (\delta_{r,g}^2 + \delta_{r,p}^2 + \delta_{r,c}^2) \\ &\quad + 30^2 \cdot g_1^2 (\delta_{s,g}^2 + \delta_{s,p}^2 + \delta_{s,c}^2) + 25 \cdot g_2^2 \\ \text{var(Liquid Waste)} &= (30 \cdot g_1^2 + 25 \cdot g_2^2) \cdot (2 \cdot \frac{2}{r,g} + \frac{2}{r,p} + \frac{2}{r,c}) \\ &\quad + (30^2 \cdot g_1^2 + 25^2 \cdot g_2^2) \cdot (\frac{2}{s,p} + \frac{2}{s,c}) \end{aligned}$$

with $g_1 = 0.024$ kg and $g_2 = 0.072$ kg, $\delta_{r,p}$ and $\delta_{s,p}$ relative standard deviation for sampling, random and systematic. Thus we get:

$$\text{var(Liquid Waste)} = 0.1905 \text{ kg}^2 \quad \delta = 0.173.$$

Overall Variance of Pu-Measurements in Flow Verification

The variance of the flow-measurements is the sum of the variances for input, product and waste measurements.

$$\text{Thus var(D)} = 31.63 \text{ kg}^2.$$

3.2 Verification of the Material Balance

In this part the same formulae hold as in (2.2). The inspector closes the material balance after the first inventory period and calculates MUF_1 . Then he performs the significance test calculating the significance threshold s_1 with the help of formula (ii) for his chosen probability α of a false alarm.

In Fig.3.6 one finds s_1 as a function of α with $\sigma_1 = 5.6$ kg. Fig.3.7 shows the probability of detection $1-\beta$ as a function of the diverted amount M of Plutonium in the case of one inventory periods with α , the probability of a false alarm as parameter.

We now come to the second inventory period. MUF_2 is calculated and a significance test is performed using the formulae (i')-(iv') in (2.2). In the case of the Alkem type plant the inventory and the total variance of the inventory measurements are small ($\text{var } I = 0.013 \text{ kg}^2$). Therefore the starting inventory for the second inventory period is approximately the same as the physical inventory (formula 2.8 of ch. I with $a = 0.0004$). Again we assume that the throughput D is the same for the two inventory periods and get $\sigma_1 = \sigma_2$, $s_1 = s_2$. Then the optimal way to choose the probabilities of a false alarm is $\alpha_1 = \alpha_2$; the optimal choice of the operator to distribute the amount M to be diverted in the course of the two inventory periods is $M_1 = M_2$. The probability of detection $1-\beta$ as a function of the diverted amount M in the case of two inventory periods is shown in Fig.3.8, the parameter is the overall probability of a false alarm (formula iv'). With the help of formula (ii'') the inspector evaluates for a fixed overall probability α of a false alarm the probabilities α_1 and α_2 . Then he finds the significance thresholds s_1 and s_2 in Fig.3.6 and can perform his significance test.

3.3 Verification of Data

In the case of the Alkem type plant the data will be verified with the help of D_1 -statistics (chapter I, 3.1 and 3.2). Not all the data, reported during an inventory period can be verified through means of D-statistics. Most of the measurements have to be supervised or done by the inspector. There remain three sets of classes of material upon which D-statistics can be employed.

The first set is liquid and dry scrap of physical inventory taking. The data used are shown in Tab.3.5, the probability of detection as a function of the diverted amount M is shown in Fig.3.9. The probability of a false alarm is fixed to be 5 %, the parameter is the effort in percent of the maximal possible effort. The optimal choice of the n_1 can be found in Tab.3.6 . The next classes are dry and liquid waste. The relevant data can be found in Tab.3.5. But the standard deviation of the measurement errors are too high so that applying variable sampling seems not to be reasonable. To justify this we compute $\text{var}(D/H_0) = 0.83 \text{ kg}^2$. Therefore for the significance thresholds holds: $s = 1.5 \text{ kg}$ for a probability of a false alarm of 5 %. (The used formula is (ii) of 3.2.2.) A first solution of that problem is to do attribute sampling and to measure all the waste batches with a high Plutonium content.

There remains the class of the fuel pins, produced during the inventory period. Though the inspector knows the content of Plutonium through the flow-measurements, he wants to have a direct method to verify the Pu-content of that class. It can be done through γ -scanning but only on a random base because of the huge number of in half a year produced pins. Additionally, the inspector only wants to make sure that the Pu-content of the pins lies inside certain boundaries. We remark here that these measurements are not the output measurements and do not burden the material balance with their uncertainty. The theoretical basis for the following discussions is the part 3.1 of chapter I.

We find the standard deviation of the sum of the measurements to be approximately 0.064 kg^2 . Therefore for a diversion of more than 0.252 kg the operator will choose $r = N$ and $\mu = M \cdot 10^{-4}$. In Fig. 3.10 we find the probability of detection as a function of the diverted amount of Plutonium, calculated for the case $r = 10,000$ and different n between $10,000$ and 500 .

Table 3.1: Data of NFS for D_1 -statistics

Stream	N(half a year)	ϵ (US\$)	σ_r^2 (kg ²)	σ_s^2 (kg ²)
Input	125	400	$1.5 \cdot 10^{-2}$	$9.8 \cdot 10^{-4}$
Product	380	200	$4.3 \cdot 10^{-4}$	$9.5 \cdot 10^{-5}$
Waste	450	40	$2.0 \cdot 10^{-4}$	$9.0 \cdot 10^{-6}$

Table 3.2: Optimal sample size for a given effort in case of D_1 -statistics

%	100	80	60	50	30	20	10	5
Effort C in US\$	144,000	115,200	86,400	72,000	43,200	28,800	14,400	7,200
n_1^o	125	125 ^{+))}	125	101	61	41	20	10
n_2^o	380	280	163	136	81	54	27	14
n_3^o	450	228	135	65	65	43	25	10
P % (M= 14kg)	76.7	76.5	76.0	72.9	72.9	70.1	63.0	51.9

^{+))} $n_1^o > N_1$, therefore full coverage in that class, $C-\epsilon_1 N_1$ distributed in an optimal way on the classes 2 and 3.

Table 3.3: Date of NFS for D_2 -statistics

Stream	N(half a year)	$\epsilon/h/$	$\sigma_r^2 / \text{kg}^2 /$	$\sigma_s^2 / \text{kg}^2 /$	$\sigma_v^2 / \text{kg}^2 /$
Input	125	2.2	$2.8 \cdot 10^{-3}$	$5.7 \cdot 10^{-4}$	0.5776
Product	380	5.25	$8.5 \cdot 10^{-3}$	$0.5 \cdot 10^{-4}$	$5.29 \cdot 10^{-2}$
Waste	450	2.6	$9 \cdot 10^{-6}$	$4.5 \cdot 10^{-6}$	$9.03 \cdot 10^{-3}$

Table 3.4: Optimal sample size for a given effort employing D_2 -statistics

%	100	80	60	50	30	20
Effort C	3,440	2,752	2,064	1,720	1,032	688
n_1^o	125	125 ^{+))}	125 ^{+))}	125 ^{+))}	125 ^{+))}	108
n_2^o	380	351	254	205	107	59
n_3^o	450	244	176	142	74	41
σ	5.854	6.274	7.113	7.764	10.310	13.992
$\beta_{M=20 \text{ kg}}$	96.3	93.8	87.9	82.6	61.8	41.7

^{+))} $n_1^o > N_1$, therefore full coverage in that class, $C-\epsilon_1 N_1$ distributed in an optimal way on the classes 2 and 3.

Table 3.5: Data of Alkem for D_1 -statistics

Class	N	σ_r^2 [kg ²]	σ_s^2 [kg ²]	ϵ [h]
Dry scrap	50	$2.45 \cdot 10^{-5}$	$8 \cdot 10^{-6}$	2.5
Liquid scrap	20	$4.51 \cdot 10^{-5}$	$1.25 \cdot 10^{-5}$	3.0
Fuel-pins	10,000	$8.8 \cdot 10^{-6}$	$3.9 \cdot 10^{-6}$	0.17
Dry waste 1	25	$2 \cdot 10^{-4}$	$2 \cdot 10^{-4}$	1
Dry waste 2	75	$2 \cdot 10^{-6}$	$2 \cdot 10^{-6}$	1
Liquid waste 1	30	$4.6 \cdot 10^{-5}$	$1.04 \cdot 10^{-4}$	3
Liquid waste 2	25	$4.15 \cdot 10^{-4}$	$9.33 \cdot 10^{-4}$	3

Table 3.6: Optimal sample size for a given effort for the classes liquid and dry scrap

%	100	80	60	50	30	20
Effort C	185	148	111	92.5	55.5	37
n_1^o	50	41	31	26	16	10
n_2^o	20	15	11	9	5	4

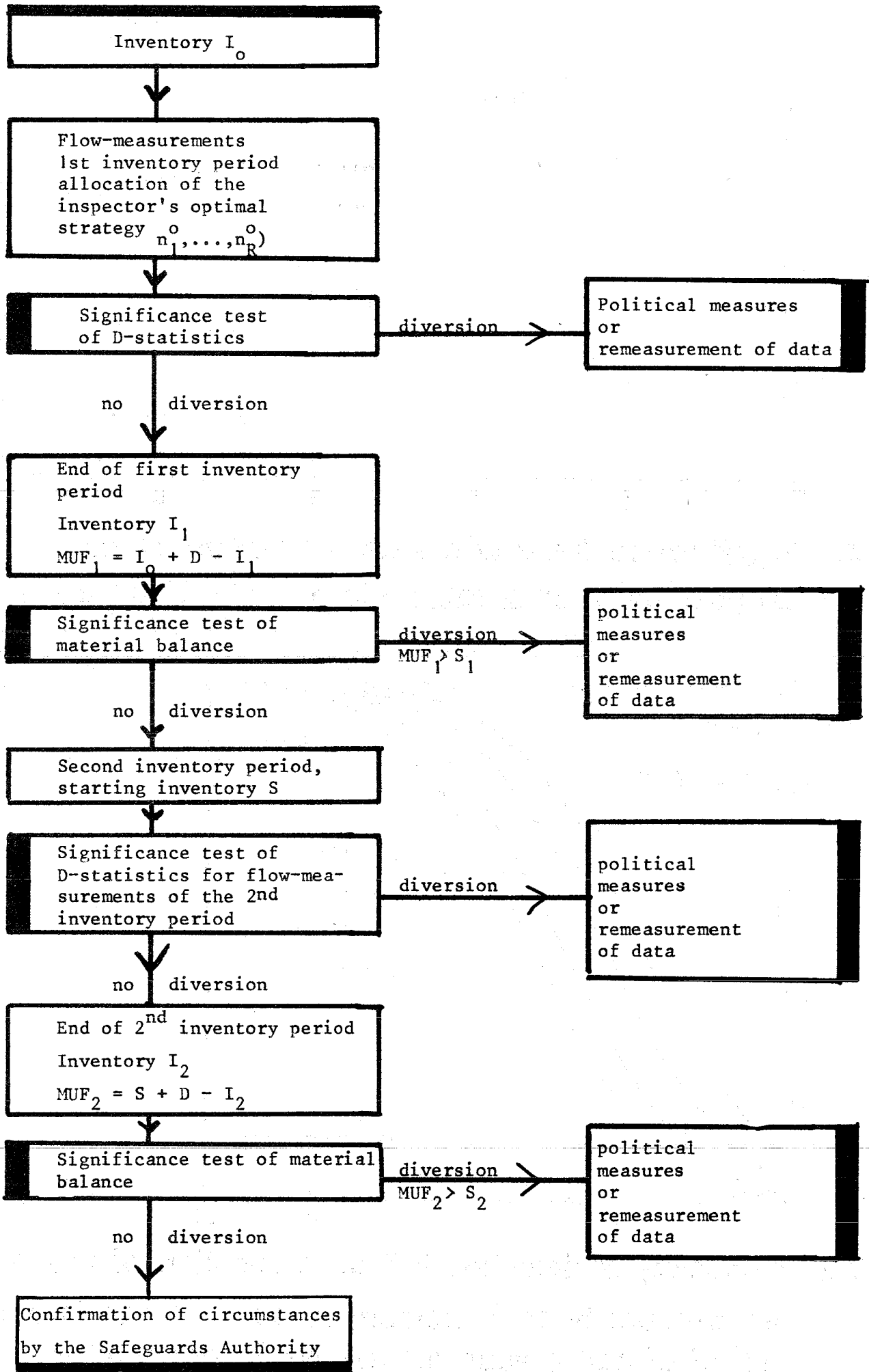

Fig. 3.0 Flow-diagram of the significance - tests

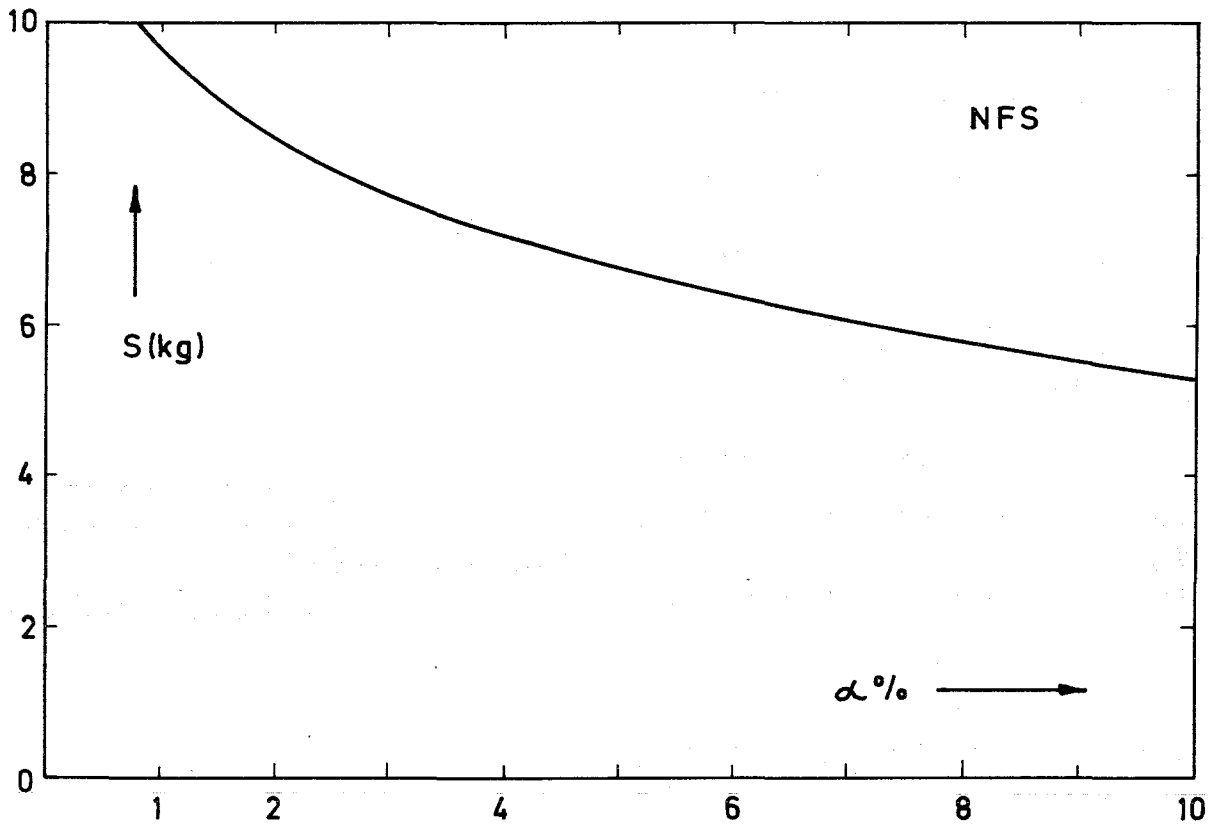

Fig. 3.1 Significance threshold s as a function of the probability α of a false alarm. ($\delta^2 = 17.02 \text{ kg}^2$)

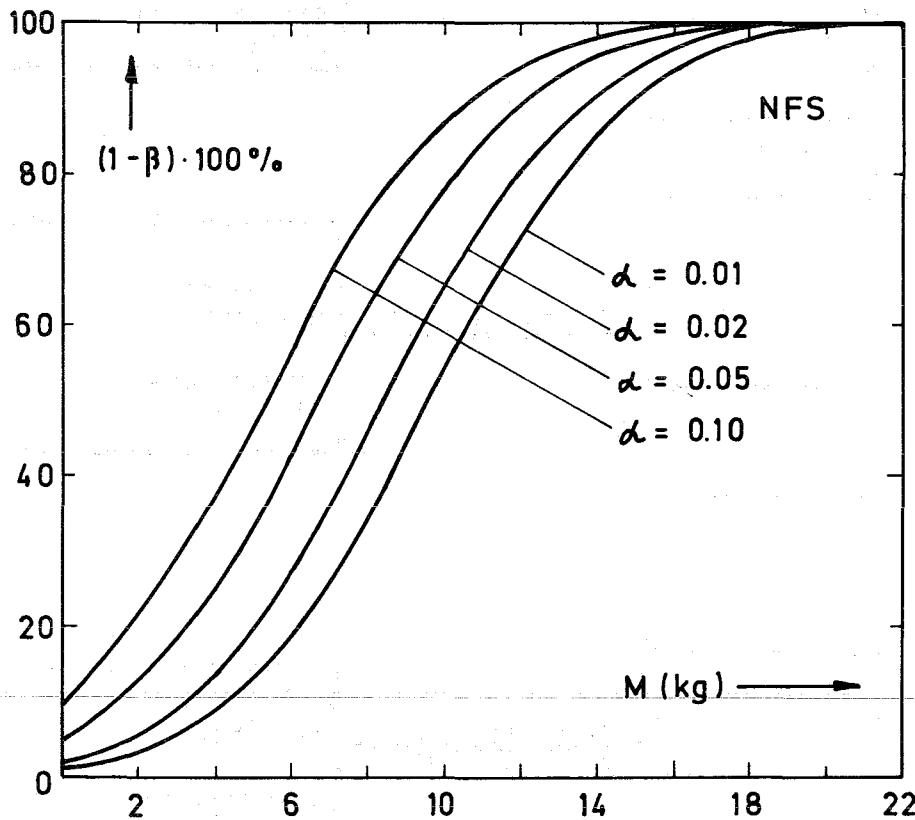

Fig.3.2 Probability of detection $1-\beta$ as a function of the diverted amount M of Plutonium in case of one inventory period of half a year for the NFS; parameter: probability α of a false alarm.

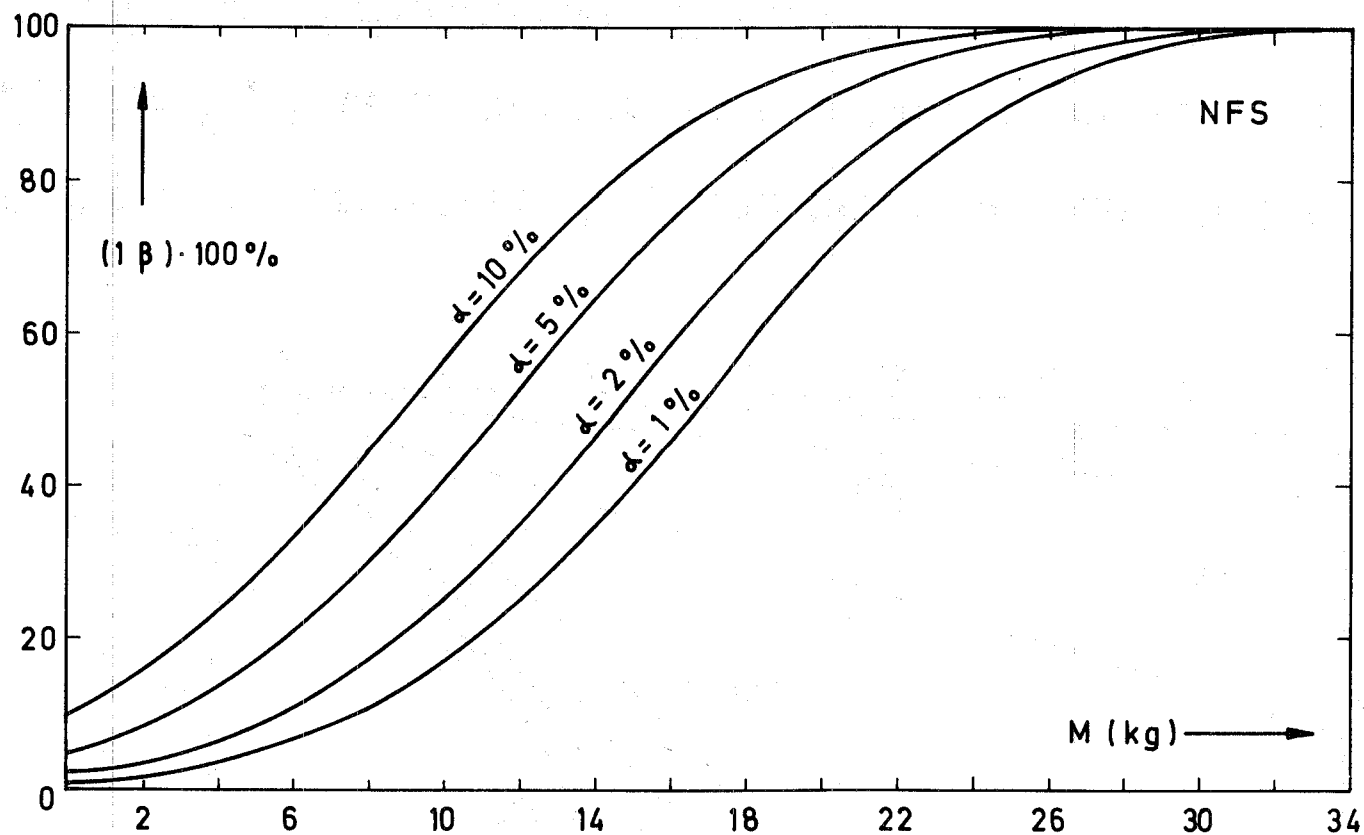

Fig.3.3 Probability of detection $1 - \beta$ as a function of the diverted amount M of Plutonium in case of two inventory periods for the NFS; parameter: probability α of a false alarm.

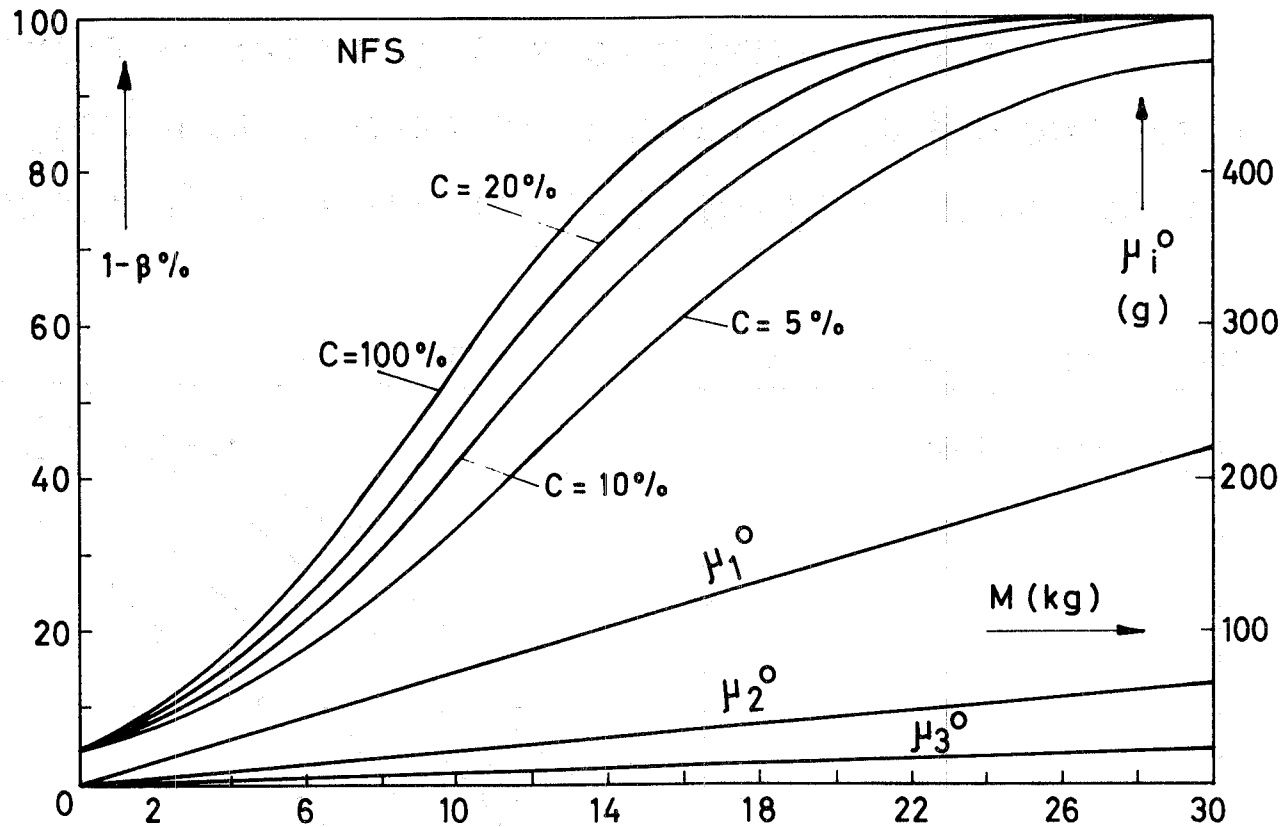

Fig.3.4 Probability of detection $1-\beta$ and per batch diverted amount μ_i^0 ($i=1,2,3, R=N/2$) as a function of the total diverted amount M in case of D_1 -statistics (Parameter: Effort)

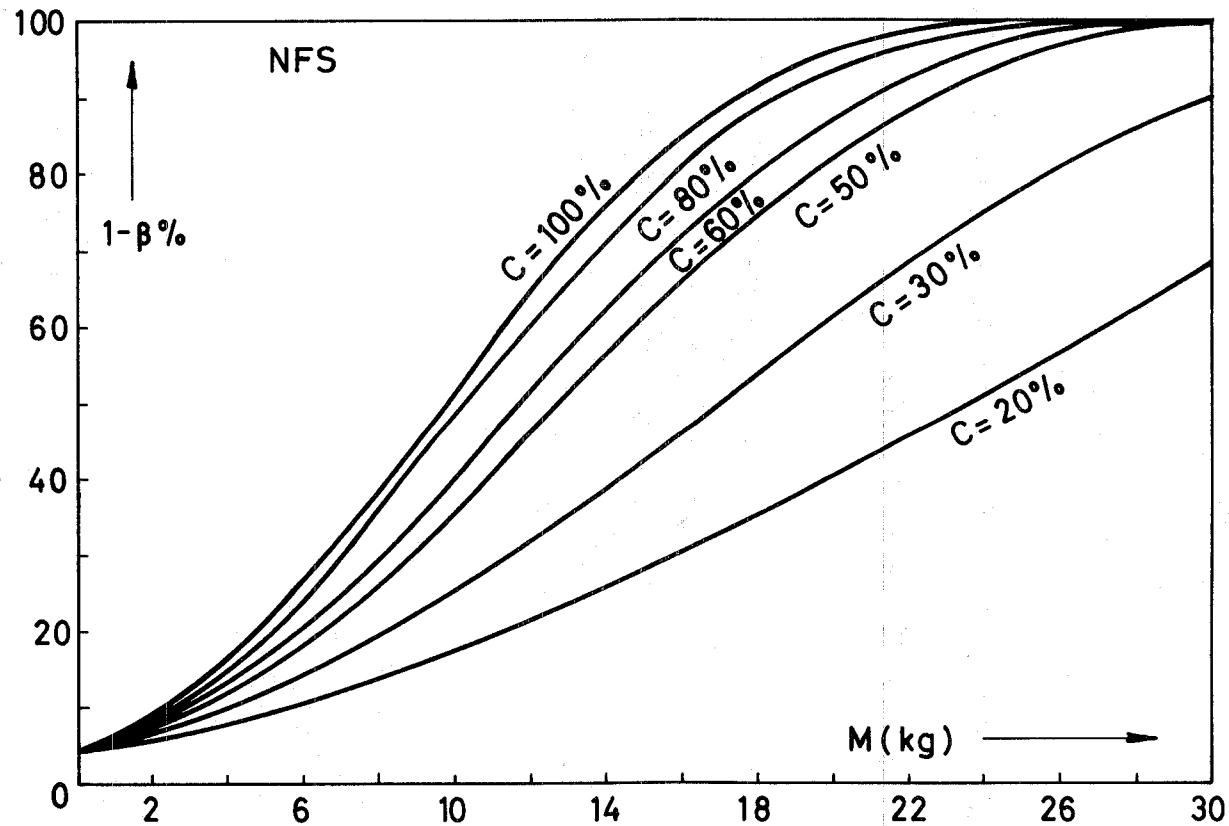

Fig.35 Probability of detection $1 - \beta$ as a function of the diverted amount M in case of D_2 - statistics (Parameter : Effort)

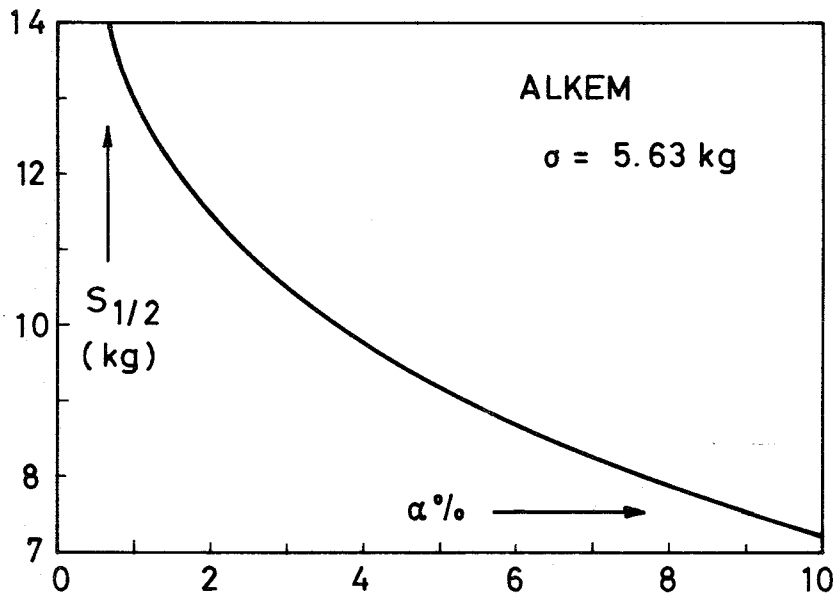

Fig.3.6 Significance threshold $s_{1/2}$ as a function of the probability α of a false alarm

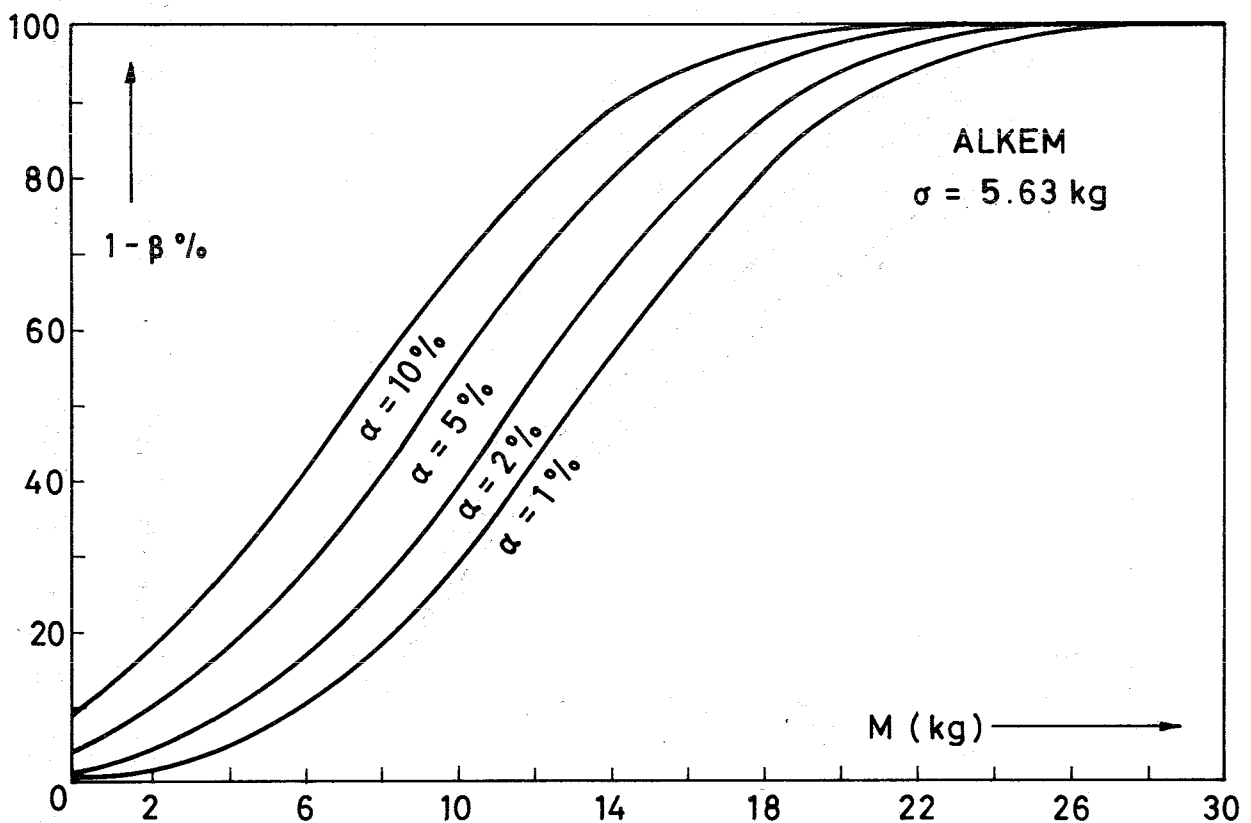

Fig.3.7 Probability of detection $1 - \beta$ as a function of the diverted amount M of Plutonium in case of one inventory period of half a year for the Alkem; parameter: probability α of a false alarm.

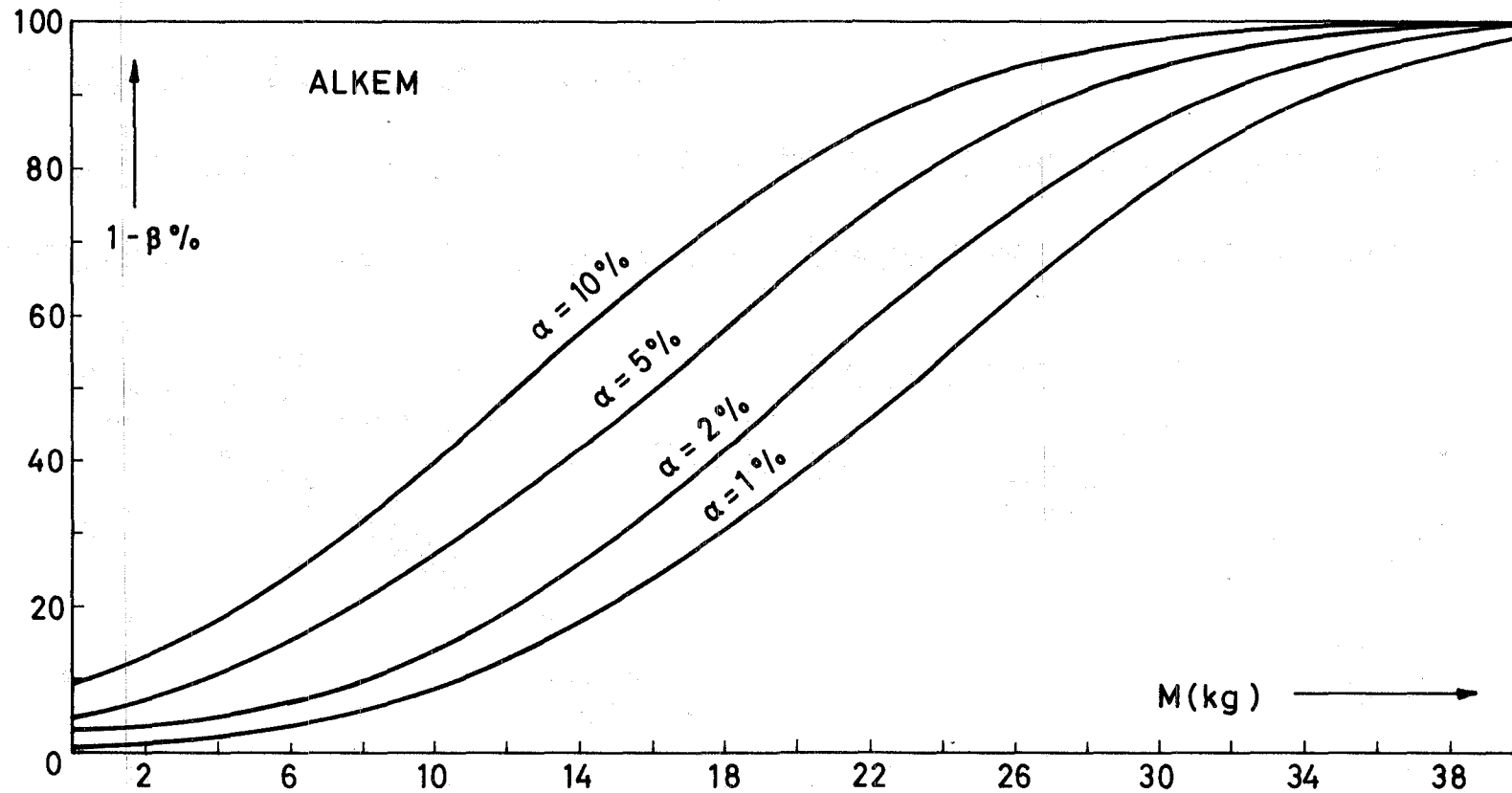

Fig.3.8 Probability of detection $1 - \beta$ as a function of the diverted amount M of Plutonium in case of two inventory periods of half a year for the Alkem; parameter: probability of false alarm.

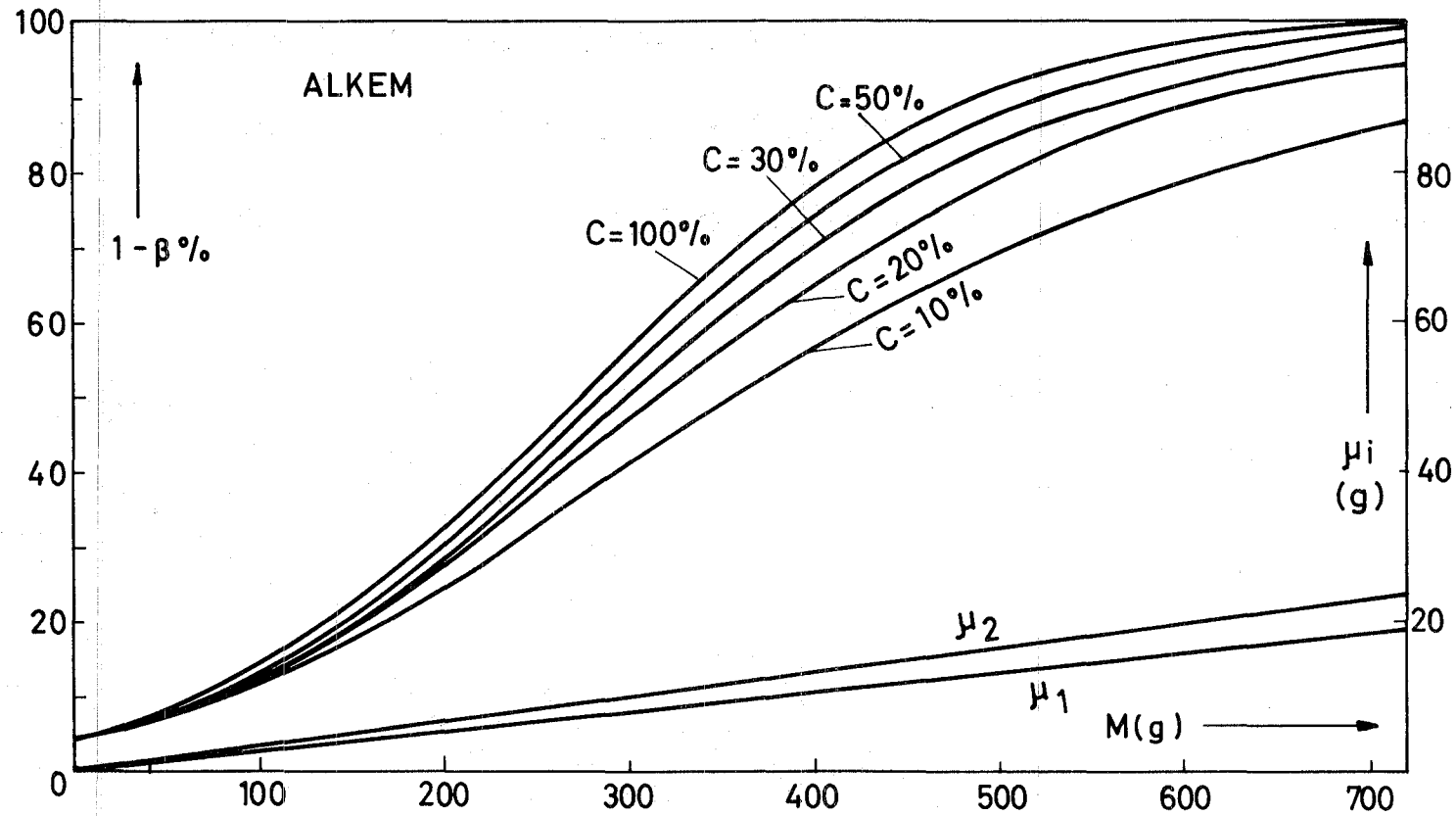

Fig.3.9 Probability of detection $1 - \beta$ and per batch diverted amount μ_i^0 ($i=1,2 R = N/2$) for the classes dry and liquid scrap as a function of the total diverted amount M_i (parameter: Effort)

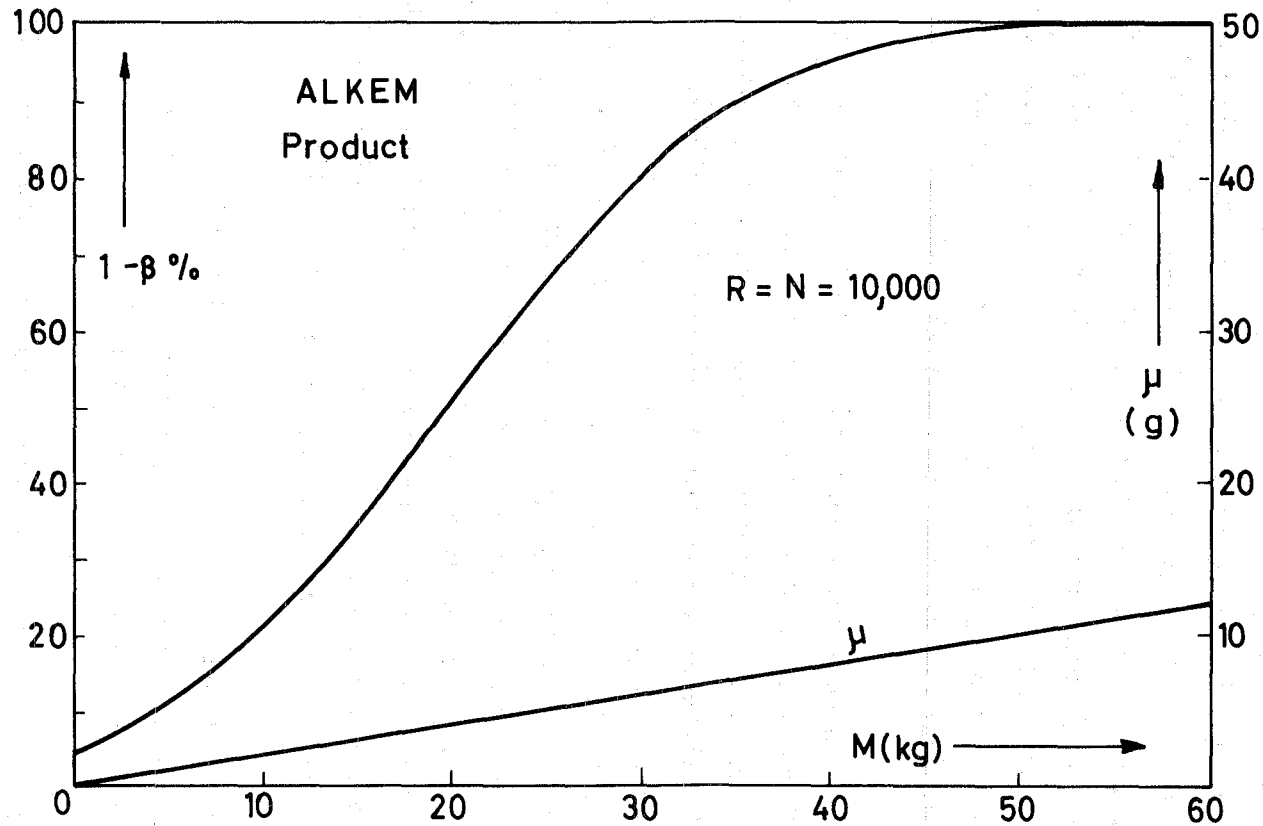

Fig.3.10 Probability of detection and per batch diverted amount μ as a function of the total diverted amount M for $n = 10,000 \dots 1000$

Conclusions

The main purpose of the investigations carried out in this report has been to show the possibilities of use of game theoretical methods in optimizing safeguards efforts of an international safeguards organization. Since the optimization process is influenced by fairly complex interrelations of a large number of factors, boundary conditions and assumptions, the conclusions which can be derived from the process and results of such an optimization, can seldom be formulated in highly generalized terms. They are always subject to the restraints used in developing the methods and the validity of the assumptions. Bearing this in mind, it appears worthwhile to draw attention to a number of conclusions. However, before that it is useful to make one point clear in connection with the decision theoretical methods.

Optimization methods based on decision theory are developed on the conflict situation arising out of the system under consideration. For an international safeguards organization the conflict situation comes out of the fundamental assumption that the probability of a diversion of fissionable material at the national level out of its peaceful nuclear sector, although small, is not zero. This basic assumption ultimately justifies the necessity of an international safeguards organization. The safeguards organization has therefore to use the methods which are aimed at countering threats of such diversions. Under such a condition, it becomes necessary to define clearly the diversion modes or threats for nuclear materials before the game theoretical methods can be used to develop the counter methods of the safeguards organization. In this report three possible modes of diversion have been considered.

- a) Diversion of material from the inputs, outputs and inventories of a plant. The data submitted by facility operators to the safeguards organizations are assumed not to be falsified.
- b) Diversion of material on the basis of some falsified data submitted to the safeguards organization. The safeguards organization has in principle the possibility of verifying all the submitted data (D_1 -statistics).

- c) Diversion of material on the basis of submitted data to the safeguards organization which the organization cannot verify afterwards. The organization has however some a-priori knowledge of the possible batch to batch variation of the content of fissionable material in the batches. The facility operator can plan a diversion only within this variation (D_2 -statistics).

The first of the above modes of diversions is possible because of the measurement uncertainties in establishing a material balance. The second two modes of diversion are possible only if the inspectors measure a part of the batches on a random sampling basis. Theoretically, these two types of diversions would not be possible if the inspectors verified the data for all the batches submitted by the facility operators. However, in reality, inspectors would seldom be in a position (because of economical or technical restrictions) to verify all the data. It is to be noted that the above mentioned diversion modes can be construed only in the framework of the safeguards system laid down in INFCIRC/153. For example, if the safeguards organization prepared its technical conclusions on the basis of the material balance established by its own measurements without taking into account the data submitted by facility operators, the mode of diversion to be considered would have been different.

The conclusions which appear relevant are now summarized.

1. In developing the decision theoretical model for the optimum strategies for inspectors and the facility operators in connection with the statement of a material balance in a facility over a given period of time, it has been assumed that two physical inventories will be taken in a year. The inspectors distribute the false alarm probabilities α_1 and α_2 amongst the two material balance periods in such a way that an overall false alarm probability $\alpha = 1 - (1 - \alpha_1)(1 - \alpha_2)$ is guaranteed. Furthermore he would like to determine the guaranteed probability of detection after taking into consideration all possible strategies with respect to the total diversion of fissionable material $M = M_1 + M_2$, which the facility operator may plan to make. The facility operators would on the other hand, like to distribute the M_1 and M_2 amount among the two material balance periods in such a way that this probability of detection is minimized.

An analysis of the existence of saddle points for the above mentioned minimax strategies shows that under the set of conditions specified in chapter I, the optimal strategies of the inspectors are independent of the total amount M assumed to be diverted by the operator.

2. For practical purposes the optimal strategy of the inspectors is sufficiently good approximated by choosing $\alpha_1 = \alpha_2 = 1 - \sqrt{1-\alpha}$.
3. Although the exact distribution of the MUF in a material balance is combined from two types of statistical distributions namely, normal distribution coming from the measurement uncertainties and hypergeometric distribution coming from the assumed mode of diversion, for all practical purposes the total MUF can be assumed to be normally distributed. This simplifies the associated algorithm and reduces the required calculation time in a very significant manner.
4. The game theoretical models for the D_1 and D_2 -statistics (for the diversion modes described under b) and c) above) are solved with the use of Lagrange multipliers under a number of simplifying assumptions (e.g. $1 \ll n_i$; $r_i \ll N_i$; $\sigma_{r_i}^2 / n_i \ll \sigma_{s_i}^2$). Keeping in view these simplifying assumptions it appears that the optimum strategies for both the inspectors and the operators are influenced mainly by the values of μ_i , i.e. the amounts assumed to be diverted from each of the batches. This fact might appear to be somewhat uncomfortable at the first glance since the inspection organization may not have information on the possible and actual amounts of μ_i . However, under practical operating conditions in a facility, material balance data cannot be manipulated in an unlimited manner. The technical conditions and tolerance specification for the various streams and inventories in a facility force the facility operator to maintain the recorded and reported data within well-defined limits. Two of such important limits are the batch to batch variation and the systematic errors of measurement for a specific batch of material. The amount of fissionable material which can be assumed to be diverted can vary only within these limits.

5. The results of the parameter variation discussed in chapter III also bring out some interesting points which permit further conclusions to be drawn. These examples illustrate the point that mathematical models however elegant and sophisticated, must be checked with the realistic values to have a feeling for the ranges of their validity and their limitations.

6. In the examples on D_1 -statistics with the data on the NFS and the Alkem type plant, it seems that for a given value of α , a variation in the inspection manhours and a variation of the numbers of samples analysed for verification, in the range of 20 % - 100 % of the full coverage, no significant change is observed with regard to the probability of detection and the amount M assumed to be diverted. In other words, safeguards efforts can be kept at a fairly low level without deteriorating the quality of a statement on the MUF and the limits of its accuracy. Also an increase in safeguards efforts beyond about 30 % of the full coverage would not bring in significant improvement in that statement. The main reason lies in the fact that in the examples analysed, the absolute value of M for a given α and β value is determined mainly by the assumed systematic errors of measurement. The influence of the random errors of measurement decreases rapidly with increasing number of the samples verified. These results point to the fact that the actual level of inspection effort will be determined after taking into account other factors than the measurement errors alone. They may be for example, the efforts required to ensure the credibility of the information obtained.

7. The results based on D_2 -statistics (input data for the NFS plant) show on the other hand, that for a given α and β value, the amount for which a diversion can be construed increases rapidly with decreasing inspection efforts. The main reason for this is the high value of batch-to-batch variation assumed in this example (+ 10 % of the mean value). The batch-to-batch variation can be expected to decrease with an increasing use of isotopic correlations and increasing standardization of fuel elements, dissolving procedures etc.

The D_2 -statistics provide a mean to the inspectors for having an idea on a diversion in those cases in which the facility operators carry out measurements in a sequential manner and the reported data cannot be verified

(for example when the batches after measurement change identity or enter a process area in which they can no longer be measured). This method is still in its initial stages of development.

8. Probable areas for further work

A careful analysis of the work carried out under the present contract indicates that further work would be useful in the following areas.

- a) In developing the methods and working out examples, the frequency of inventory/a has been fixed as a boundary condition. Two inventories/a were used mainly after taking into consideration the operation practices in a facility. However the area of frequency of inventories and detection time appears to be worthwhile exploring. For example the number of inventories/a may not be fixed but to be chosen - subjected by constraints as costs per inventory - in such a way that the overall probability of detection is maximized. Another extension would be that within a given sequence of inventories/a the safeguards organization would like to detect a diversion of a given amount as early as possible under a given set of conditions whereas, the facility operator would like to distribute the same amount amongst the inventory periods in such a manner that the detection is delayed as much as possible. What would be the optimum strategies of both? The game theoretical model developed in this report may be expanded to incorporate such variations.
- b) As mentioned earlier, the solutions of the minimax problem for the two strategies based on D_1 - and D_2 -statistics have been obtained by the use of Lagrange multipliers. The limitations of such a solution are well known. Among others, the n_i and r_i have to be assumed to be continuous variables (which is not so serious for large n_i and r_i) and the restrictions $n_i \leq N_i$; $r_i \leq N_i$ cannot be built in into the method which often leads to solutions with $n_i > N_i$ or $r_i > N_i$. Besides, it is not always evident whether the solution gives an absolute or a relative minimum/maximum. It is therefore necessary to analyse this method more deeply and investigate the possibility of using other methods for the solution of similar problems.

- c) The possibility of extending the use of the models considered to a fuel cycle consisting of a number of different types of facilities can be investigated in detail. This may include among others analysis of the possibility of a rationalization of the frequency and sequence of inventories/a in the whole fuel cycle as well as rationalization of the distribution of safeguards efforts in all the facilities in the cycle.

The safeguards project at Karlsruhe is expected to continue to work in the above mentioned fields in the coming years.

Acknowledgement

The authors would like to express their thanks to the Management and operation staff of the firm Alkem for valuable discussions on the input data which could be used for such a plant and also for making available some of the operation data. They would like to mention particularly P. Kurz in this connection. Similarly, they would also like to thank the experts of the IAEA (in particular, H. Frittum, J. Lovett, B. Sharp) for assisting them in establishing the data for the NFS plant. Thanks are also due to W. Häfele for his support and interest in this work.

The first part of the document discusses the importance of maintaining accurate records of all transactions and activities. It emphasizes the need for transparency and accountability in financial reporting. The second part outlines the specific procedures and controls that should be implemented to ensure the integrity of the data. This includes regular audits, internal controls, and the use of reliable accounting software. The final section provides a summary of the key findings and recommendations for improving the overall financial management process.

The following table provides a detailed breakdown of the financial data for the period under review. It includes information on revenue, expenses, and net income, categorized by department and project. The data shows a steady increase in revenue over the period, which is primarily driven by the completion of several major projects. However, there is a corresponding increase in expenses, particularly in the area of personnel and materials. The net income remains positive, indicating that the organization is operating profitably.